



Challenge Electronics

95 East Jefryn Boulevard
Deer Park, NY 11729

EMAIL: SALES@CHALLELEC.COM

Tel: 1-800-722-8197

1-631-595-2217

Fax: 1-631-586-5899

• ISO 9001:2000

• ISO 14001:2004

• ISO/TS 16949:2002



WEB: WWW.CHALLENGEELECTRONICS.COM

PRODUCT INFORMATION

PART #	CEM-C9745JAD462P2.54R	Revision	0-2010
---------------	------------------------------	-----------------	---------------

Omni-Directional Foil Electret Condenser Microphone

DESCRIPTION

Omni-Directional Foil Electret Microphone, 9.7 mm diameter and 4.5 mm high, Power Supply 5.0 V max, External Resistance Loading of 680 Ω, and sensitivity of -44 dB. Terminated with 2 solder points, Lead Free RoHS Compliant

SPECIFICATIONS:

Direction	Omni Directional Foil Electret		Minimum Direction sensitivity		
Operating Voltage Range	Vs= 1.0 Vdc ~ 10.0 Vdc		Power Supply (Vs)		1.5 V
Frequency Range	100 ~ 10,000 Hz.		Maximum Current		0.5 mA
Sensitivity	- 46 ± 2.0, (0 dB = 1V / Pa) at 1K Hz.		Minimum Sensitivity to Noise Ratio		58 dB
Sensitivity Reduction	3.0 V to 2.0 V -3 dB		Maximum input S.P.L.		110 dB at 1.0 KHz, THD <1%
Operating Temperature	-20°C to + 60°C		Storage Temperature		-40°C to + 75°C
Loading Resistance (RL)	External, 680 Ω at Vs = 1.5 V, Max. 2,200 Ω		Built in Capacitors		None
Termination	PC Pins, 4.5 mm Long, 0.6 mm Ø, 2.54 mm Spacing				
Dimensions	Length / Diameter	9.7 mm Ø	Height	4.5 mm	Housing Material Al-Mg Alloy. Color
Approximate Weight	0.7 grams	Options		Compliance	RoHS, Lead Free

Reliability

Thermal Operating Cycle Test	250 hours continuous operation at Rated Power , at Maximum Rated Operating Temperature *
	250 hours continuous operation at Rated Power , at Minimum Rated Operating Temperature *
Thermal Storage Cycle Test	Parts are subjected to 250 hours storage at Maximum Rated Storage Temperatures *
	Parts are subjected to 250 hours storage at Minimum Rated Storage Temperatures *
Thermal Shock Test:	Parts are subjected to five (5) cycles of Minimum and Maximum Operating Temperature . Each cycle shall be set per diagram below and is three (3) hours long *
Humidity Test	Parts are subjected to 240 Hours at +40°C±2°C. 90-95% RH *
Vibration Test	Parts are subjected to 2 Hours of at 1.5 mm with 10 to 55 Hz. vibration frequency to each of 3 perpendicular directions *
Drop Test	Parts are dropped naturally from 1 meter height onto the surface of 40 mm wooden board, 2 axes (X,Y) directions, 3 times (6 times total) *
Reliability Test Performance *	Parts should conform to original performance within ±5 dB tested with Rated Power , after 3 hours of recovery period .
Termination Strength	Terminals should withstand a 1.0 Kg. pull test for up to 1 minute.
Life Test	At rated voltage in room temperature continuously for 1,000 hours
Warranty	For a period of one (1) year from date of shipping under normal operations conditions

Typical Frequency Response

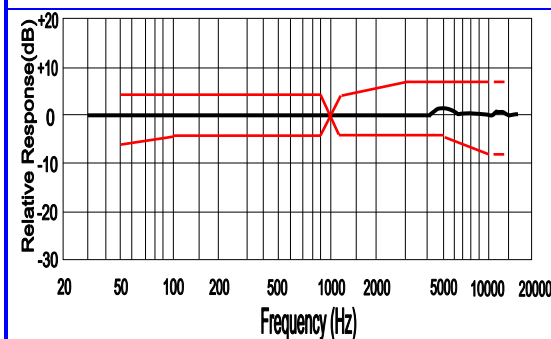

Microphone Response Toll Window

Frequency (Hz)	Lower Limit (dB)	Upper Limit (dB)
50	-6	+3
100	-3	+3
800	-3	+3
1000	0	0
1200	-3	+3
3000	-3	+8
5000	-3	+8
10000	-8	+8

Dimensions

Units in: mm Tolerance: ±0.3 mm

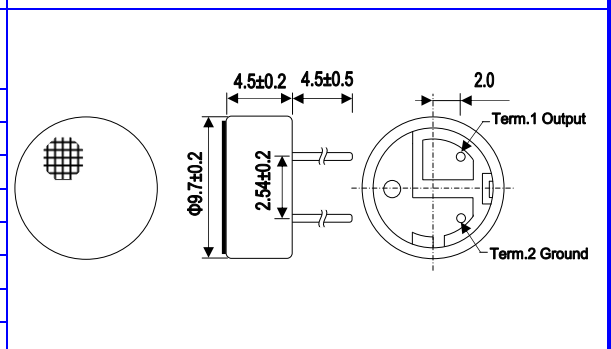

The information contained herein is believed to be correct, but no guarantee or warranty, express or implied, with respect to accuracy, completeness or results is extended and no liability is assumed. Challenge Electronics reserves the right to make changes in any specification, data or material contained herein.

Copyright © 2010 Challenge Electronics



Soldering Instructions

- Soldering temperature should be controlled under 320 and soldering time for each terminal should be 1~2 sec..
- Microphone should be fixed on the metal block (heat sink), which has high radiation effects, and heat sink shall contact with MIC tightly.
- Microphone may easily be destroyed by the static electricity. All countermeasure for eliminating static electricity must be executed (worktable and human body shall be ground connection)

Shape of heat sink

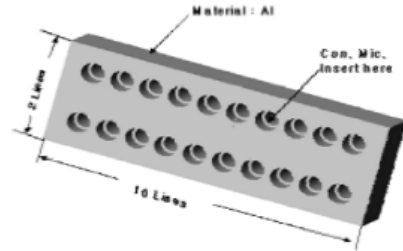

Shape of hole at fixed part Heat Sink

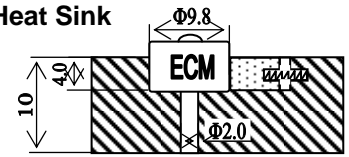

Packaging

1.1 Anti-Static Bag
Parts

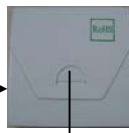

1.2 Small Box
100 Parts

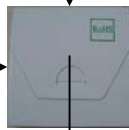

X 60

1.3 Middle Box
6,000 Parts



X 2

1.4 Shipping Carton
12,000 Parts



4. Shipping Label

1. Dimensions:	Length	Width	Height
1.1 Anti-Static Bag:	mm	mm	mm
1.2 Small Box:	100 mm	100 mm	5 mm
1.3 Middle Box:	450 mm	280 mm	135 mm
1.3 Carton Size:	550 mm	230 mm	235 mm
2. Quantity:	2.1 In Anti Static Box	100 parts	
	2.2 In mid. Size box	6,000 parts.	
	2.3 In master box	12,000 parts	
3. Weight:	3.1 One Part:	0.7 gram	
	3.2 Net Weight:	8.4 kg	
	3.3 Gross Weight:	12 kg	
4. Label Directions:	4.1 Contents should be visible clearly.		

Schematic Drawing

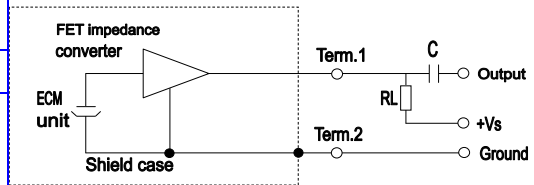

$R_L = 680 \Omega$

$V_S = 1.5 V$

$C = 1 \mu F$

Construction Materials

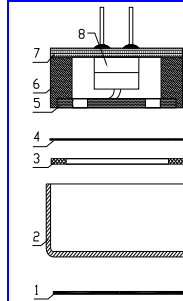

#	Name	Material	QTY
1	Dustproof gauze		1
2	Case	Al-Mg Alloy	1
3	Diaphragm	DUPONT	1
4	Spacer		1
5	Electret Plate	Copper blank	
6	Housing Chamber		1
7	PCB	FR4	1
8	FET		1
9	PC Pins		2

Testing Procedure

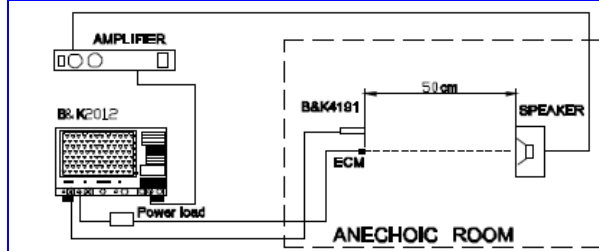

- Measure the microphones under standard operating condition.
- Put the microphone and standard microphone face to the sound source (speaker), the distance between sound source and microphone & standard microphone is 50cm. And keep the center distance 5cm between them to ensure that the change of sound pressure should be kept within ± 1 dB.
- Keep the sound source pressure within ± 1 dB from speaker Measured by standard microphone.

The sensitivity of microphone can obtain its output voltage when sound source kept within 1,000Hz & 0.1Pa.

Testing Condition

In Normal Weather	In Arbitrate Weather
Environment Temperature: 5~+35°C	Environment Temperature: 20±2°C
Relative Humidity: 45 ~ 85%	Relative Humidity: 60 ~ 70%
essure: 86 ~ 106Kpa	Air Pressure: 86 ~ 106Kpa



Компания «ЭлектроПласт» предлагает заключение долгосрочных отношений при поставках импортных электронных компонентов на взаимовыгодных условиях!

Наши преимущества:

- Оперативные поставки широкого спектра электронных компонентов отечественного и импортного производства напрямую от производителей и с крупнейших мировых складов;
- Поставка более 17-ти миллионов наименований электронных компонентов;
- Поставка сложных, дефицитных, либо снятых с производства позиций;
- Оперативные сроки поставки под заказ (от 5 рабочих дней);
- Экспресс доставка в любую точку России;
- Техническая поддержка проекта, помощь в подборе аналогов, поставка прототипов;
- Система менеджмента качества сертифицирована по Международному стандарту ISO 9001;
- Лицензия ФСБ на осуществление работ с использованием сведений, составляющих государственную тайну;
- Поставка специализированных компонентов (Xilinx, Altera, Analog Devices, Intersil, Interpoint, Microsemi, Aeroflex, Peregrine, Syfer, Eurofarad, Texas Instrument, Miteq, Cobham, E2V, MA-COM, Hittite, Mini-Circuits, General Dynamics и др.);

Помимо этого, одним из направлений компании «ЭлектроПласт» является направление «Источники питания». Мы предлагаем Вам помощь Конструкторского отдела:

- Подбор оптимального решения, техническое обоснование при выборе компонента;
- Подбор аналогов;
- Консультации по применению компонента;
- Поставка образцов и прототипов;
- Техническая поддержка проекта;
- Защита от снятия компонента с производства.



Как с нами связаться

Телефон: 8 (812) 309 58 32 (многоканальный)

Факс: 8 (812) 320-02-42

Электронная почта: org@eplast1.ru

Адрес: 198099, г. Санкт-Петербург, ул. Калинина, дом 2, корпус 4, литера А.