



# MAX9959 Evaluation Kit

Evaluates: MAX9959

## General Description

The MAX9959 evaluation kit (EV kit) provides a proven design to evaluate the MAX9959 device power supply (DPS). The EV kit also includes Windows® 2000/XP®- and Windows Vista®-compatible software that provides a simple graphical user interface (GUI) for exercising the features of the MAX9959. The MAX9959 EV kit PCB comes with a MAX9959DCCQ+ installed.

## Ordering Information

PART	TYPE
MAX9959EVKIT+	EV Kit

+Denotes lead(Pb)-free and RoHS compliant.

Windows, Windows XP, and Windows Vista are registered trademarks of Microsoft Corp.

SPI is a trademark of Motorola, Inc.

## Features

- ◆ Windows 2000/XP- and Windows Vista (32-Bit)-Compatible Software
- ◆ USB-PC Connection (Cable Included)
- ◆ SPI™ Interface Terminals
- ◆ Uses the MAX5735 to Provide Analog Input Settings
- ◆ Uses the MAX531 to Provide Ground-Sense Shifting
- ◆ On-Board Reference (MAX6126)
- ◆ On-Board Regulators Generate All Required Voltages from ±12V
- ◆ External Load Sensing
- ◆ Proven PCB Layout
- ◆ Includes Heatsink and Fan
- ◆ Lead(Pb)-Free and RoHS Compliant
- ◆ Fully Assembled and Tested
- ◆ Two On-Board MAX9959s Allow Master/Slave Capabilities

## Component List

DESIGNATION	QTY	DESCRIPTION
C1, C3–C10, C17, C24, C26, C32, C37, C49–C53, C55–C62	27	0.1µF ±10%, 16V X7R ceramic capacitors (0603) TDK C1608X7R1C104K
C2, C13, C15, C23, C25, C31, C36, C48	8	10µF ±20%, 6.3V X5R ceramic capacitors (0805) TDK C2012X5R0J106M
C11, C12	2	10pF ±5%, 50V C0G ceramic capacitors (0603) TDK C1608C0G1H100J
C14, C16, C27, C30, C35	5	1µF ±20%, 6.3V X5R ceramic capacitors (0603) TDK C1608X5R0J105M
C18, C19	2	22pF ±5%, 50V C0G ceramic capacitors (0603) TDK C1608C0G1H220J
C20	1	3300pF ±10%, 50V X7R ceramic capacitor (0603) TDK C1608X7R1H332K
C28, C33, C39, C41, C44–C47, C84–C87	12	0.1µF ±20%, 50V X7R ceramic capacitors (0603) TDK C1608X7R1H104M

DESIGNATION	QTY	DESCRIPTION
C29, C34, C38, C40, C42, C43	6	10µF ±10%, 25V X5R ceramic capacitors (1210) TDK C3225X5R1E106K
C54, C88–C91	0	Not installed, capacitors (0603)
C63	1	33µF ±20%, 6.3V X5R ceramic capacitor (1206) TDK C3216X5R0J336M
C64, C65, C81, C82	4	270pF ±5%, 50V C0G ceramic capacitors (0402) Taiyo Yuden UMK105CG271JV-F
C66, C83, C96–C99	6	330pF ±10%, 50V X7R ceramic capacitors (0603) TDK C1608X7R1H331K
C67, C74, C92, C93	4	1500pF ±10%, 50V X7R ceramic capacitors (0603) TDK C1608X7R1H152K
C68, C75	2	0.01µF ±10%, 50V X7R ceramic capacitors (0603) TDK C1608X7R1H103K
C69, C76	2	0.022µF ±10%, 50V X7R ceramic capacitors (0603) Murata GRM188R71H223K
C70, C71, C77, C78	4	4700pF ±10%, 50V X7R ceramic capacitors (0603) Murata GRM188R71H472K



# MAX9959 Evaluation Kit

Evaluates: MAX9959

## Component List (continued)

DESIGNATION	QTY	DESCRIPTION
C72, C73, C79, C80	4	100pF ±5%, 50V C0G ceramic capacitors (0603) Murata GRM1885C1H101J
C94, C95	2	3300pF ±10%, 50V X7R ceramic capacitors (0603) Murata GRM188R71H332K
D1	1	Green LED (0603)
D2, D3	0	Not installed, zener diodes
D4–D13	10	Red LEDs (0603)
FB1–FB4	4	Ferrite beads, 3A, 200Ω at 100MHz (0603) TDK MPZ1608S221A
J0	0	Not installed, dual-row (2 x 5) 10-pin header
J2, J3	2	Dual-row (2 x 8) 16-pin headers
J8, J9	2	3-pin headers
J10–J17	8	Dual-row (2 x 5) 10-pin headers
JUA–JUE	0	Not Installed, PCB shorted trace
JU1–JU4	4	3-pin headers
JU5, JU10	2	Triple-row (3 x 4) 12-pin headers
JU6, JU9, JU14–JU19	8	2-pin headers
JU11	1	Triple-row (3 x 10) 30-pin header
P1	1	USB type-B right-angle female receptacle
P2–P6, P8, P10, P11, P12, P14, P16	11	Binding posts
R1	1	220Ω ±5% resistor (0603)
R2, R34, R35, R49, R51, R55, R57, R59, R75, R77, R81, R83, R85	13	10kΩ ±5% resistors (0603)
R3	1	2.2kΩ ±5% resistor (0603)
R4	1	1.5kΩ ±5% resistor (0603)
R5, R6	2	27Ω ±5% resistors (0603)
R7, R9, R11, R32, R42, R43, R67, R68	8	1kΩ ±1% resistors (0603)

DESIGNATION	QTY	DESCRIPTION
R8	1	1.4kΩ ±1% resistor (0603)
R10, R12	2	3.01kΩ ±1% resistors (0603)
R13, R14, R15	3	0Ω ±5% resistors (0805)
R16, R19, R20, R22, R24, R26, R28, R30	8	6.98kΩ ±1% resistors (0603)
R17, R18, R21, R23, R25, R27, R29, R31	8	4.99kΩ ±1% resistors (0603)
R33	1	0Ω ±5% resistor (0603)
R36, R38, R61, R63	4	10Ω ±1% range A resistors (2512)
R37, R39, R62, R64	4	3.3Ω ±1% range A resistors (2512)
R40, R41, R65, R66	4	100Ω ±1% resistors (1206)
R44, R60, R69, R70	4	10kΩ ±1% resistors (0603)
R45, R46, R47, R71, R72, R73, R90–R99	0	Not installed, resistors (2512)
R48, R50, R54, R56, R58, R74, R76, R80, R82, R84	10	1kΩ ±5% resistors (0603)
R52, R53, R78, R79, R86–R89, R100, R101	0	Not installed, resistors (0603)
R102	1	200Ω ±1% resistor (0603)
TP1, TP3, TP5, TP7, TP8, TP19, TP35	7	Red test points
TP4, TP6, TP9	3	Black test points
TP2, TP10–TP16, TP20–TP24, TP28, TP31–TP34, TP39, TP40	0	Not installed, red miniature test points

# MAX9959 Evaluation Kit

Evaluates: MAX9959

## Component List (continued)

DESIGNATION	QTY	DESCRIPTION
TP17, TP18, TP25, TP26, TP27, TP29, TP30, TP36, TP37, TP38	10	Red miniature test points
U1, U2	2	Digital power supplies (100 TQFP-EPR-IDP) Maxim MAX9959DCCQ+
U3	1	Low-cost microcontroller (68 QFN-EP*) Maxim MAXQ2000-RAX+
U4	1	93C46 type (64k x 16) 3-wire EEPROM (8 SO)
U5	1	UART-to-USB converter (32 TQFP)
U6	1	3.3V regulator (5 SC70) Maxim MAX8511EXK33+T (Top Mark: AEI)
U7	1	2.5V regulator (5 SC70) Maxim MAX8511EXK25+T (Top Mark: ADV)
U9, U10	2	Adjustable positive-voltage regulators (3 TO220)
U11	1	Adjustable negative-voltage regulator (3 TO220)
U12, U13	2	Quad op-amp ICs (14 TSSOP)

DESIGNATION	QTY	DESCRIPTION
U14	1	Low-noise precision reference (8 SO) Maxim MAX6126AASA30+
U15	1	32-channel, 16-bit DAC (56 TQFN-EP*) Maxim MAX5735BUTN+
U16	1	12-bit serial DAC (14 SO) Maxim MAX531ACSD+
U17, U18	2	Quad SPDT analog switches (20 SSOP) Maxim MAX4533EAP+
U19	0	Not installed, external buffer (7 TO220)
Y1	1	16MHz crystal (HCM49) Hong Kong X'tals SSM1600000E18FAF
Y2	1	6MHz crystal (HCM49) Hong Kong X'tals SSL6000000E18FAF
—	2	Fans, heatsink, 5V, 30mm x 30mm x 20mm Cofan 30-1779 Rev A
—	38	Shunts
—	1	PCB: MAX9959 EVALUATION KIT+

\*EP = Exposed pad.

## Component Suppliers

SUPPLIER	PHONE	WEBSITE
Hong Kong X'tals Ltd	852-35112388	www.hongkongcrystal.com
Murata Electronics North America, Inc.	770-436-1300	www.murata-northamerica.com
Taiyo Yuden	800-348-2496	www.t-yuden.com
TDK Corp.	847-803-6100	www.component.tdk.com

**Note:** Indicate that you are using the MAX9959 when contacting these component suppliers.

## MAX9959 EV Kit Files

FILE	DESCRIPTION
INSTALL.EXE	Installs the EV kit files on your computer
MAX9959.EXE	Application program
FTD2XX.INF	USB device driver file
UNINST.INI	Uninstalls the EV kit software
USB_Driver_Help.PDF	USB driver installation help file

# MAX9959 Evaluation Kit

## Quick Start

### Required Equipment

- MAX9959 EV kit (USB cable included)
- User-supplied Windows 2000/XP or Windows Vista PC with a spare USB port
- $\pm 12V$ , 2A power supply
- Two digital voltmeters

**Note:** In the following sections, software-related items are identified by bolding. Text in **bold** refers to items directly from the EV kit software. Text in **bold and underlined** refers to items from the Windows operating system.

### Procedure

The MAX9959 EV kit is fully assembled and tested. Follow the steps below to verify board operation:

- 1) Visit [www.maxim-ic.com/evkitsoftware](http://www.maxim-ic.com/evkitsoftware) to download the latest version of the EV kit software, 9959Rxx.ZIP. Save the EV kit software to a temporary folder and uncompress the ZIP file.
- 2) Install the EV kit software on your computer by running the INSTALL.EXE program inside the temporary folder. The program files are copied and icons are created in the Windows **Start | Programs** menu.
- 3) Verify that all jumpers are in their default positions, as shown in Table 1.
- 4) Connect the USB cable from the PC to the EV kit board. A **New Hardware Found** window pops up when installing the USB driver for the first time. If you do not see a window that is similar to the one described above after 30 seconds, remove the USB cable from the board and reconnect it. Administrator privileges are required to install the USB device driver on Windows.
- 5) Follow the directions of the **Add New Hardware Wizard** to install the USB device driver. Choose the **Search for the best driver for your device** option. Specify the location of the device driver to be **C:\Program Files\MAX9959** (default installation directory) using the **Browse** button. During device driver installation, Windows may show a warning message indicating that the device driver Maxim uses does not contain a digital signature. This is not

an error condition and it is safe to proceed with installation. Refer to the USB\_Driver\_Help.PDF document included with the software for additional information.

- 6) Apply +12V to VCC (P2) and -12V to VEE (P4).
- 7) Start the MAX9959 EV kit software by opening its icon in the **Start | Programs** menu. The EV kit software main window appears, as shown in Figure 1.
- 8) In the **MAX9959 Settings** group box, click on the **FV** radio button in the **Set Measurement Mode** group box.
- 9) In the **MAX5735 Settings** group box, change the voltage for **VIN** to +1V.
- 10) Check that the output voltage at DUT\_NODE\_M (P8) is close to +1V. Figure 2 shows the MAX9959 EV kit quick start settings.

## Detailed Description of Software

The main window of the evaluation kit software is shown in Figure 1.

### MAX9959 Settings

The MAX9959 supports an 18-bit word SPI interface. The GUI provides a simple way to correlate setting changes with bit settings. There are two on-board MAX9959 devices connected in a daisy-chain configuration. U1 can be considered the *Master* and is denoted with an *\_M* in the schematic, U2 can be considered the *Slave* and is denoted with an *\_S* in the schematic, but both devices can be programmed to operate independently. Because of the daisy-chain configuration, the bit stream for U2 goes through U1 first. To avoid accidental programming of a device when communicating with another device in the daisy chain, bit 0 masks writing to the MAX9959 and bit 1 masks the loading of the settings. Both bits are automatically updated when using **Master** and **Master1/Master2** modes. The default setting by the GUI is **Manual Control** and allows the user to set all settings independently. Selecting **Master**, **Master/Slave**, or **Master1/Master2** forces certain bit settings that are required for that mode.

The **Set Measurement Mode** group box is a quick way to set the MAX9959 to force voltage (**FV**), force current (**FI**), force current as a slave device (**FI Slave**), or place into high impedance (**Hi-Z**). Bit settings are automatically changed to match mode settings.

# MAX9959 Evaluation Kit

Evaluates: MAX9959

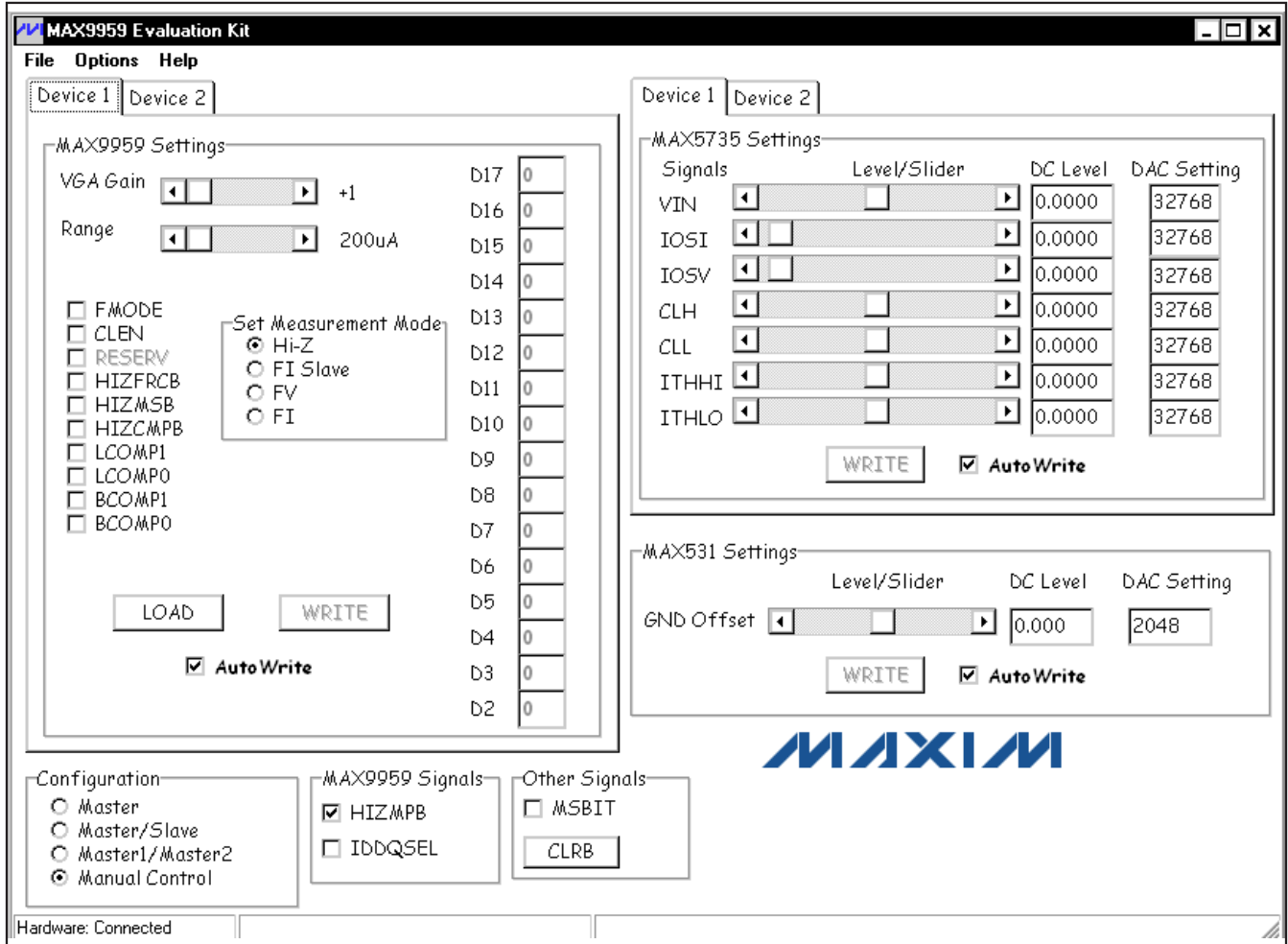

Figure 1. MAX9959 EV Kit Software Main Window at Startup

### MAX5735 Settings

The MAX5735 outputs voltages for both MAX9959 devices. The output voltages are set by moving the scrollbars located in the **MAX5735 Settings** group box or by entering data in the corresponding edit boxes and pressing *Enter* on the keyboard. The edit boxes accept the value of the voltage or binary code. Changes in the **DC Level** edit boxes automatically change the values in the **DAC Setting** edit boxes and vice versa. The min and max values allowed for each analog voltage setting set their scrollbar ranges. Analog voltages (**VIN**, **IOSI**, **IOSV**, **CLH**, **CLL**, **ITHHI**, and **ITHLO**) are set by the MAX5735 and appear as the input levels for the MAX9959. The MAX5735 has two tabs (**Device 1** and **Device 2**) to change the analog input voltages for both MAX9959 devices.

### MAX531 Settings

The MAX531 can be used for calibration by shifting the GND sense on the MAX5735. The GND shift on the MAX5735 should not exceed  $\pm 0.5V$  and the **GND Offset** scrollbar inside the **MAX531 Settings** group box is limited to that range.

### AutoWrite

The **AutoWrite** checkboxes can be checked to have the software automatically perform write operations. This feature allows the user to change settings and have them updated without pressing the **WRITE** buttons. There is an **AutoWrite** checkbox for writing to the MAX9959, MAX5735, and MAX531. Each device can independently perform auto writing. **AutoWrite** is enabled by default.

# MAX9959 Evaluation Kit

Evaluates: MAX9959

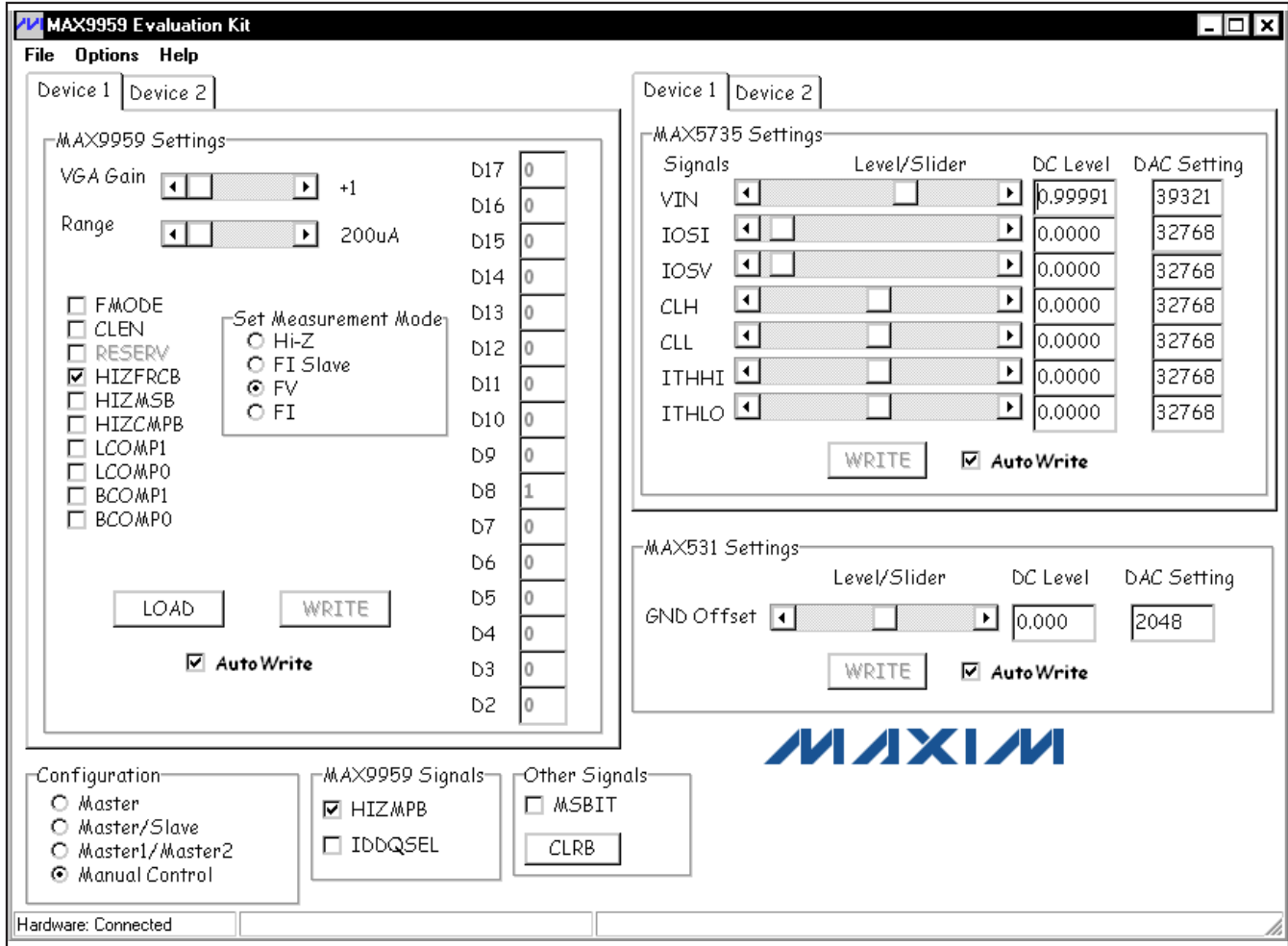

Figure 2. MAX9959 EV Kit Quick Start Settings

## Signals

**MSBIT**, **HIZMPB**, **IDDQSEL**, and **CLRb** are signals that can be used in different settings. **HIZMPB** and **IDDQSEL** are signals for the MAX9959. Each MAX9959 device can have its own set of **HIZMPB** and **IDDQSEL** signals, but the EV kit shares the same set of signals for both MAX9959 devices on-board. The **HIZMPB** signal is shared in functionality with the **HIZMSB** bit and internally both bits are ANDed. **CLRb** resets the MAX5735 and MAX531 outputs to 0V, and sets **CLH** to the max value and **CLL** to its min value. **MSBIT** is used for **Master/Slave** configuration. **MSBIT** is only selectable in **Manual Control**.

## Detailed Description of Hardware

The MAX9959 EV kit provides a proven reference design for connecting two MAX9959 devices in a daisy-

chain configuration. Headers for power, SPI, and analog voltages are provided for customized testing. The MAX5735 provides the analog voltages to the MAX9959. The MAX531 provides the GND-shifting voltage for calibrating the GND level on the MAX5735. The MAX5735 is a 32-channel DAC, but only 14 channels are used in the MAX9959 EV kit design. Headers J2 and J3 provide test points for the MAX5735 outputs. Various test points are available for different signals and LEDs indicate status information. The EV kit uses banana plugs for the outputs and inputs because of their high-current capability. Fan headers are provided to power two fans to cool the MAX9959 devices. Operating without the fans does not damage the MAX9959 devices even at high current because they have a thermal-shutdown feature that shuts off the IC when the die temperature exceeds the thermal limit.

# MAX9959 Evaluation Kit

Evaluates: MAX9959

## User-Supplied Power Supply

The MAX9959 EV kit is powered by  $\pm 12V$ . On-board regulators generate +5V, -5V, and +3V. The regulators are used by default, but changing the jumper position on JU1, JU2, and JU3 allows user-supplied power (see

Table 1 for jumper configurations). User-supplied power is useful when isolating the supply current to individual devices. The USB-to-SPI circuitry is fully powered by USB power and can be detected without  $\pm 12V$  present. Power should always be present before running the software.

**Table 1. MAX9959 EV Kit Jumper Descriptions (JU1–JU6, JU9, JU10, JU11, JU14–JU19)**

JUMPER	SHUNT POSITION	DESCRIPTION
JU1	1-2*	+3V is generated on-board through a regulator
	2-3	+3V is supplied externally
JU2	1-2*	+5V is generated on-board through a regulator
	2-3	+5V is supplied externally
JU3	1-2*	-5V is generated on-board through a regulator
	2-3	-5V is supplied externally
JU4	1-2	Connects the MAX5735 GS input to GND
	2-3*	Connects the MAX5735 GS input to MAX531 output
JU5A	Open*	Reserved
JU5B	Open*	Reserved
JU5C	Open*	Reserved
JU5D	1-2*	Normal operation
	2-3	Reserved
JU6	Open	DUT SENSE pin not connected to DUT_NODE (U2)
	Closed*	DUT SENSE pin connected to DUT_NODE (U2)
JU9	Open*	Sets internal threshold voltage to half of logic voltage for U1
	Closed	Sets internal threshold voltage to minimum for U1
JU10A	Open*	Reserved
JU10B	Open*	Reserved
JU10C	Open*	Reserved
JU10D	1-2*	Normal operation
	2-3	Reserved
JU11	(See Table 2)	
JU14	Open*	Sets internal threshold voltage to half of logic voltage for U2
	Closed	Sets internal threshold voltage to minimum for U2
JU15	Open*	Normal operation
	Closed	Reserved
JU16	Open*	VRXP sense input not connected
	Closed	VRXP sense input connected
JU17	Open	DUT sense not connected to DUT_NODE (U1)
	Closed*	DUT sense connected to DUT_NODE (U1)
JU18	Open	GND sense not connected to GND (U1)
	Closed*	GND sense connected to GND (U1)
JU19	Open	GND sense not connected to GND (U2)
	Closed*	GND sense connected to GND (U2)

\*Default position.

# MAX9959 Evaluation Kit

## User-Supplied Interface (On-Board Headers)

The MAX9959 EV kit uses ten signal lines from the microcontroller for operation. The signal lines go to JU11 and shunting the 1-2 position (default) uses the on-board signals to operate the evaluation kit. Switching the shunts to the 2-3 position allows user-supplied signals to operate the evaluation kit. The external signals are applied to headers J11, J13, J15,

and J17. Headers J11 and J13 contain the digital bits, and headers J15 and J17 contain the analog voltages. Headers J10, J12, J14, and J16 can be used as test points, but are available to connect to another MAX9959 EV kit board. The outputs on headers J10, J12, J14, and J16 can connect to the inputs on headers J11, J13, J15, and J17 with the shunt positions changed to the 2-3 position on JU11. This allows multiple boards to be paralleled.

**Table 2. JU11 Jumper Description**

JU11 ROWS	SHUNT POSITION	DESCRIPTION
Row A	1-2*	MAXQ microcontroller-generated DIN
	2-3	External DIN
Row B	1-2*	MAXQ microcontroller-generated SCLK
	2-3	External SCLK
Row C	1-2*	MAXQ microcontroller-generated $\overline{CS}$ for MAX9959
	2-3	External $\overline{CS}$ for the MAX9959
Row D	1-2*	MAXQ microcontroller-generated $\overline{CS}$ for MAX5735
	2-3	External $\overline{CS}$ for the MAX5735
Row E	1-2*	MAXQ microcontroller-generated $\overline{CS}$ for MAX531
	2-3	External $\overline{CS}$ for the MAX531
Row F	1-2*	MAXQ microcontroller-generated MSBIT
	2-3	External MSBIT
Row G	1-2*	MAXQ microcontroller-generated $\overline{LOAD}$
	2-3	External $\overline{LOAD}$
Row H	1-2*	MAXQ microcontroller-generated $\overline{HIZMP}$
	2-3	External $\overline{HIZMP}$
Row I	1-2*	MAXQ microcontroller-generated $\overline{IDDQSEL}$
	2-3	External $\overline{IDDQSEL}$
Row J	1-2*	MAXQ microcontroller-generated $\overline{CLR}$ (internal use only)
	2-3	External $\overline{CLR}$

**Table 3. Analog Voltage Settings J2 Header Description**

J2	MAX5735 SIGNAL NAME	J2	MAX9959 SIGNAL NAME
1	OUT0_B	2	ITHLO_M
3	OUT1_B	4	ITHHI_M
5	OUT2	6	IOSI_M
7	OUT3	8	IOSV_M
9	OUT4	10	VIN_M
11	OUT5_B	12	CLL_M
13	OUT6_B	14	CLH_M

**Note:**  $OUT\_B$  is a buffered version of  $OUT\_$ .



# MAX9959 Evaluation Kit

Evaluates: MAX9959

**Table 4. Analog Voltage Settings J3 Header Description**

J3	MAX5735 SIGNAL NAME	J3	MAX9959 SIGNAL NAME
1	OUT10_B	2	ITHLO_SAS
3	OUT11_B	4	ITHHI_SAS
5	OUT12	6	IOSI_SAS
7	OUT13	8	IOSV_SAS
9	OUT14	10	VIN_SAS
11	OUT15_B	12	CLL_SAS
13	OUT16_B	14	CLH_SAS

**Note:** OUT1\_B is a buffered version of OUT1\_.

**Table 5. MAX9959 EV Kit J10 Header Description**

J10	MAX9959 SIGNAL NAME	J10	MAX9959 SIGNAL NAME
1	DOUT_S	2	GND
3	SCLK	4	GND
5	$\overline{CS}$	6	GND
7	$\overline{LOAD}$	8	GND
9	$\overline{CLR}$	10	GND

**Table 6. MAX9959 EV Kit J11 Header Description**

J11	MAX9959 SIGNAL NAME	J11	MAX9959 SIGNAL NAME
1	EXT_DIN	2	GND
3	EXT_SCLK	4	GND
5	$\overline{EXT\_CS}$	6	GND
7	$\overline{EXT\_LOAD}$	8	GND
9	$\overline{EXT\_CLR}$	10	GND

**Table 7. MAX9959 EV Kit J12 Header Description**

J12	MAX9959 SIGNAL NAME	J12	MAX9959 SIGNAL NAME
1	IDDQSEL	2	GND
3	$\overline{HIZMP}$	4	GND
5	MSBIT	6	GND
7	$\overline{CSD}$	8	GND
9	$\overline{CS\_GS}$	10	GND

# MAX9959 Evaluation Kit

**Table 8. MAX9959 EV Kit J13 Header Description**

J13	MAX9959 SIGNAL NAME	J13	MAX9959 SIGNAL NAME
1	EXT_IDDQSEL	2	GND
3	EXT_HIZMP	4	GND
5	EXT_MSBIT	6	GND
7	EXT_CSDAC	8	GND
9	EXT_CS_GS	10	GND

**Table 9. MAX9959 EV Kit J14 Header Description**

J14	MAX9959 SIGNAL NAME	J14	MAX9959 SIGNAL NAME
1	IPAR_S	2	GND
3	CLH_S	4	GND
5	CLL_S	6	GND
7	VIN_S	8	GND
9	IOSV_S	10	GND

**Table 10. MAX9959 EV Kit J15 Header Description**

J15	MAX9959 SIGNAL NAME	J15	MAX9959 SIGNAL NAME
1	GND	2	IOSV_M
3	GND	4	VIN_M
5	GND	6	CLL_M
7	GND	8	CLH_M
9	GND	10	VINS_M

**Table 11. MAX9959 EV Kit J16 Header Description**

J16	MAX9959 SIGNAL NAME	J16	MAX9959 SIGNAL NAME
1	IOSI_S	2	GND
3	ITHHI_S	4	GND
5	ITHLO_S	6	GND
7	RFU2	8	GND
9	RFU1	10	GND

**Table 12. MAX9959 EV Kit J17 Header Description**

J17	MAX9959 SIGNAL NAME	J17	MAX9959 SIGNAL NAME
1	IOSI_M	2	GND
3	ITHHI_M	4	GND
5	ITHLO_M	6	GND
7	—	8	—
9	—	10	—

# MAX9959 Evaluation Kit

Evaluates: MAX9959

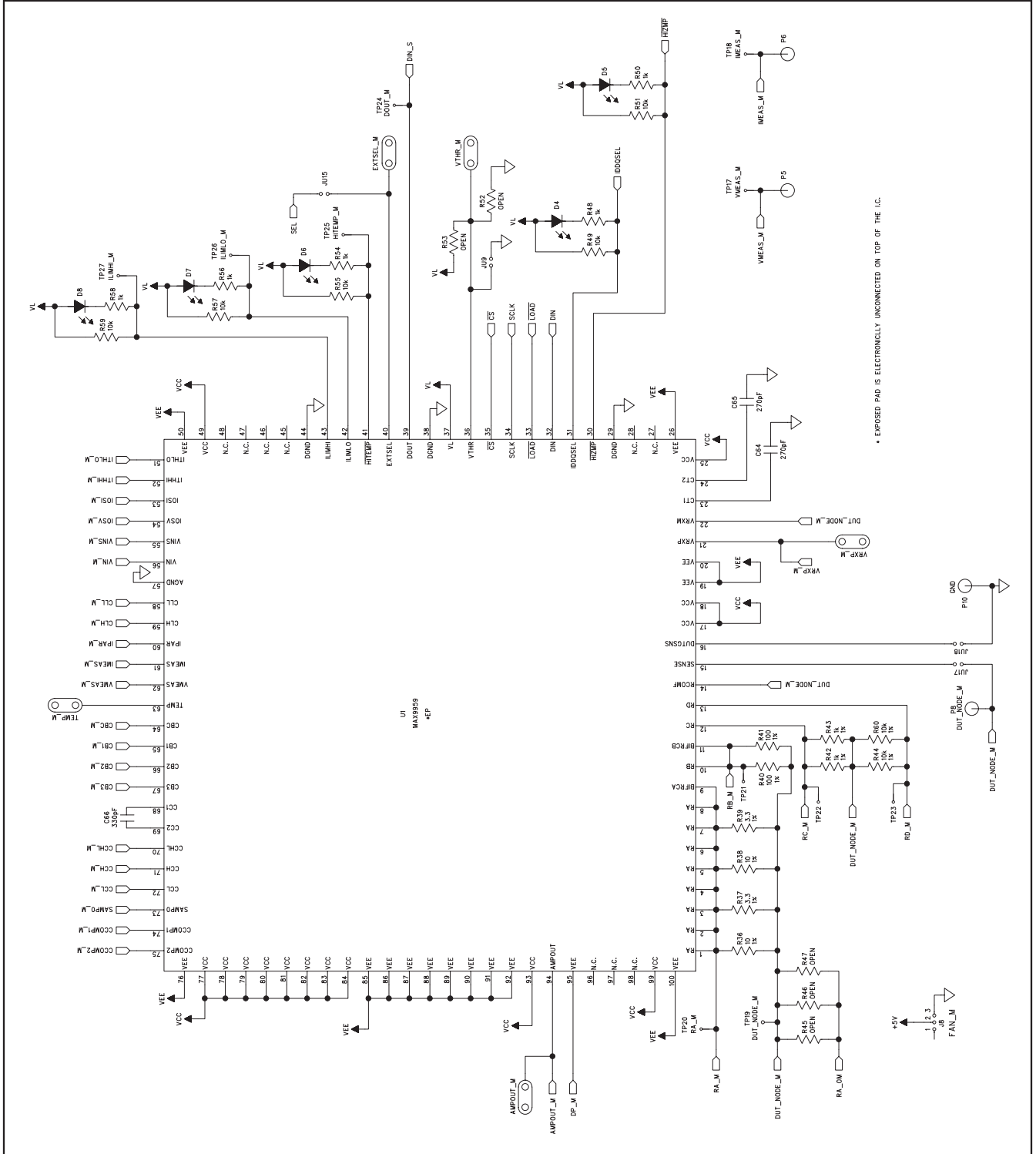

Figure 3a. MAX9959 EV Kit Schematic (Sheet 1 of 8)

# MAX9959 Evaluation Kit

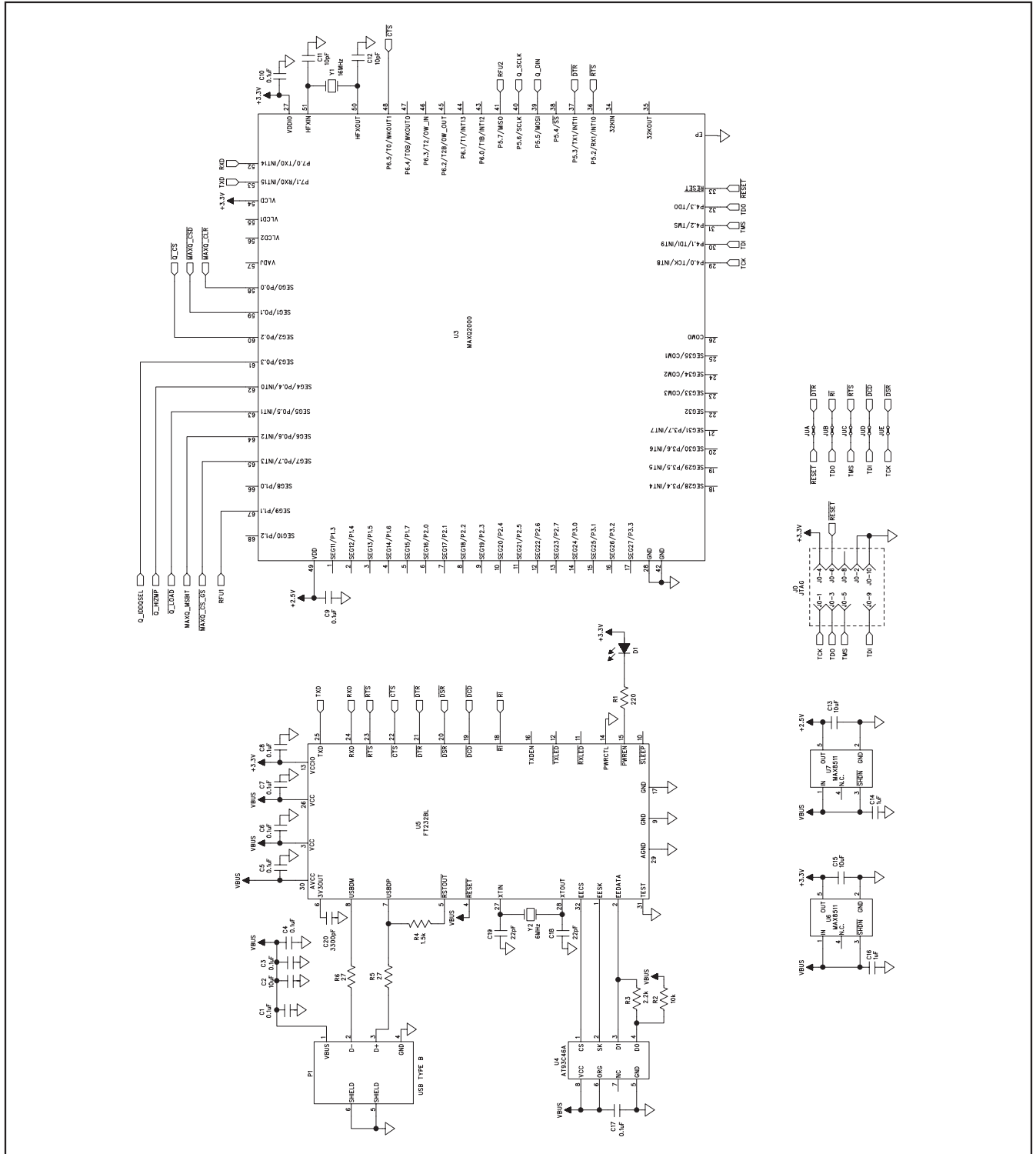

Figure 3b. MAX9959 EV Kit Schematic (Sheet 2 of 8)

# MAX9959 Evaluation Kit

Evaluates: MAX9959

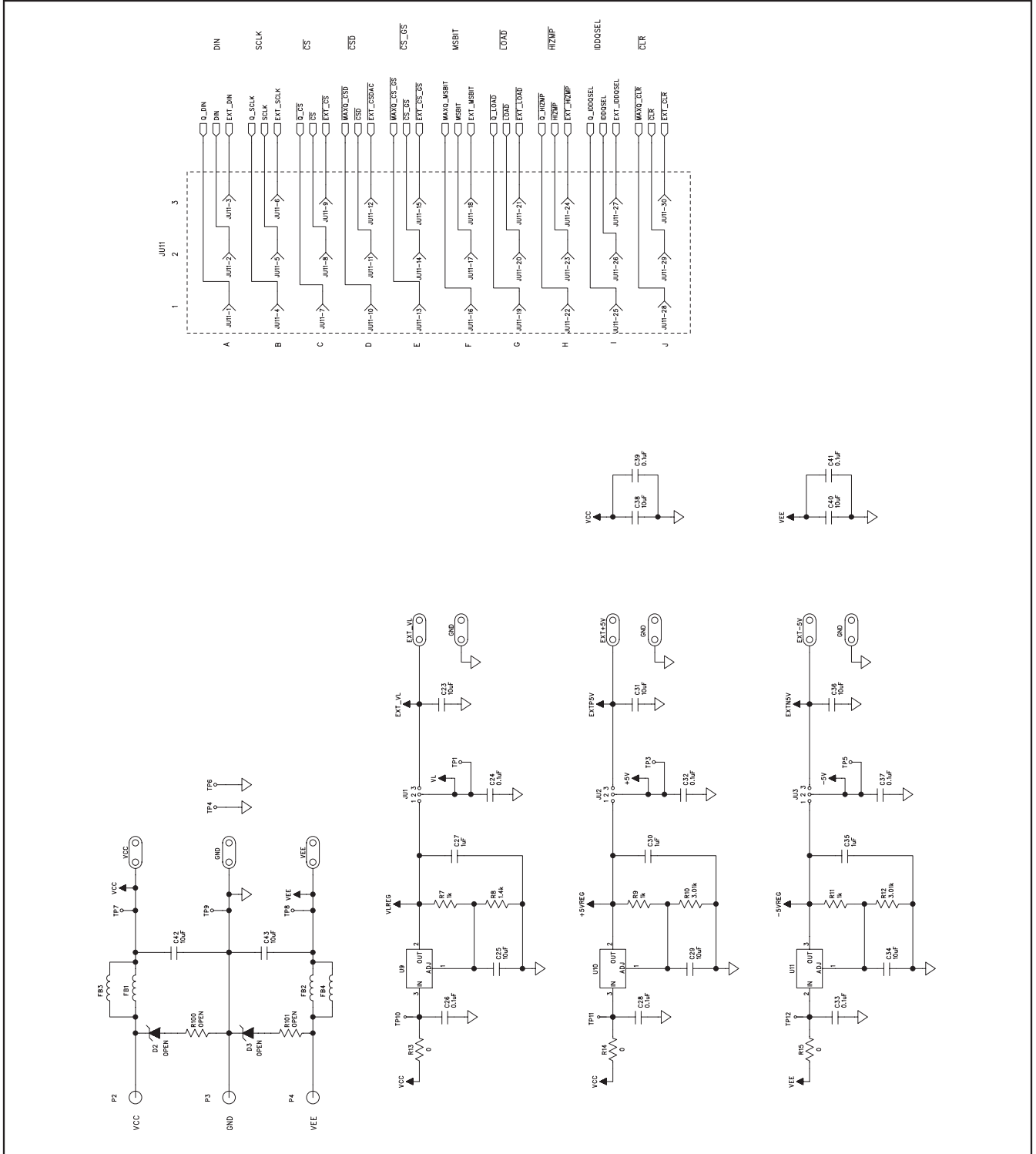

Figure 3c. MAX9959 EV Kit Schematic (Sheet 3 of 8)

# MAX9959 Evaluation Kit

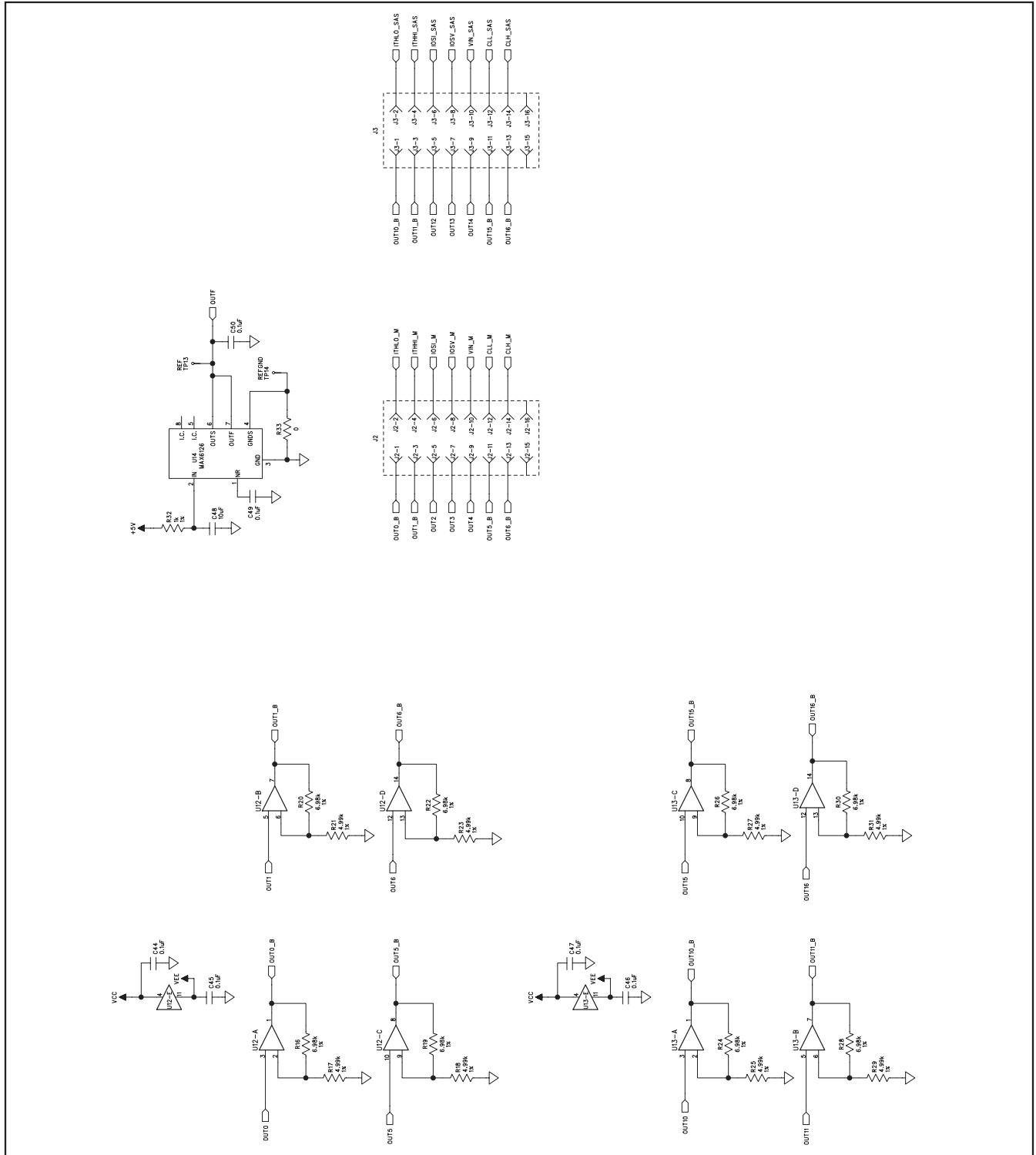

Figure 3d. MAX9959 EV Kit Schematic (Sheet 4 of 8)

# MAX9959 Evaluation Kit

Evaluates: MAX9959

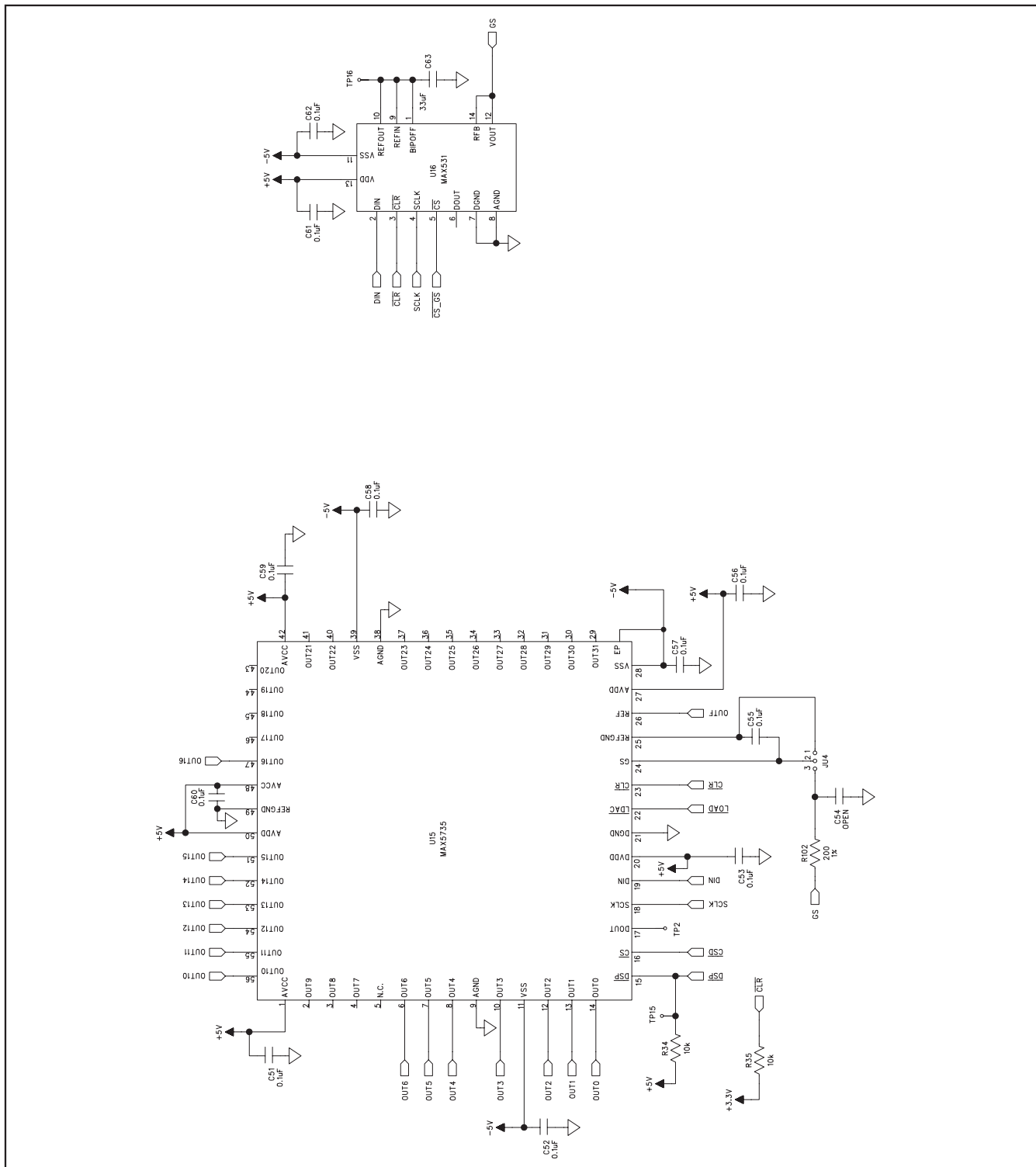

Figure 3e. MAX9959 EV Kit Schematic (Sheet 5 of 8)

# MAX9959 Evaluation Kit

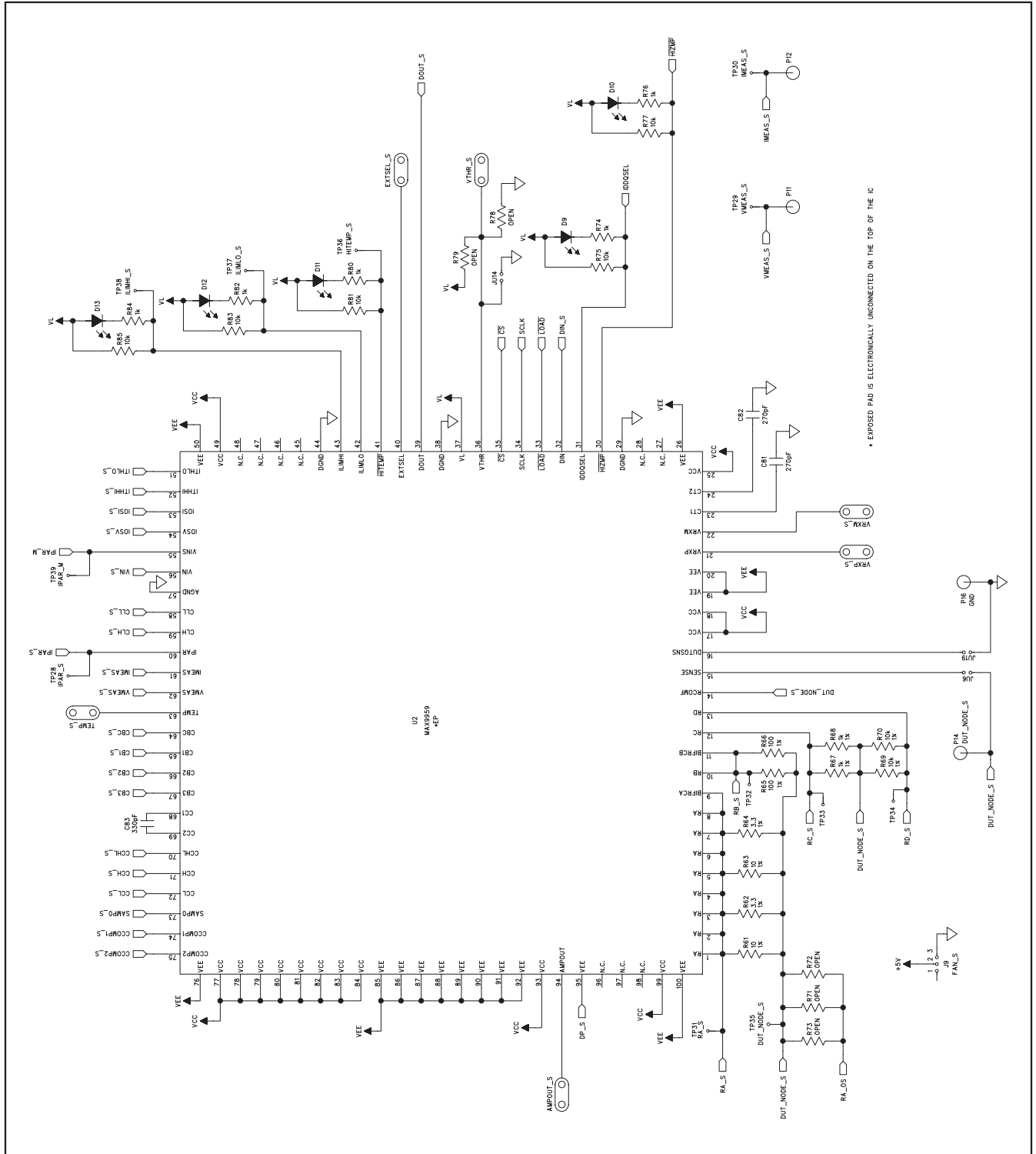

Figure 3f. MAX9959 EV Kit Schematic (Sheet 6 of 8)



# MAX9959 Evaluation Kit

Evaluates: **MAX9959**

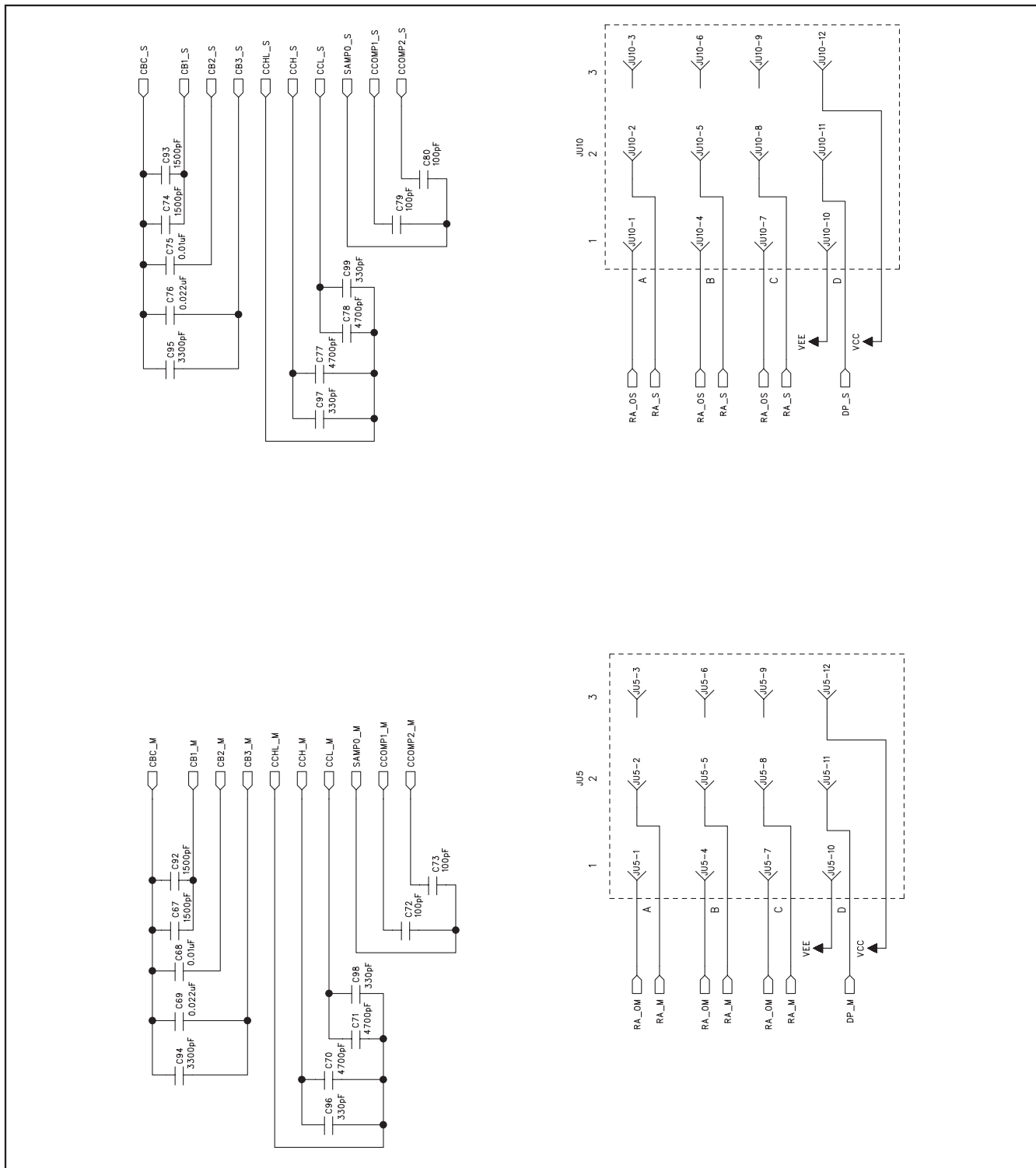

Figure 3g. MAX9959 EV Kit Schematic (Sheet 7 of 8)

# MAX9959 Evaluation Kit

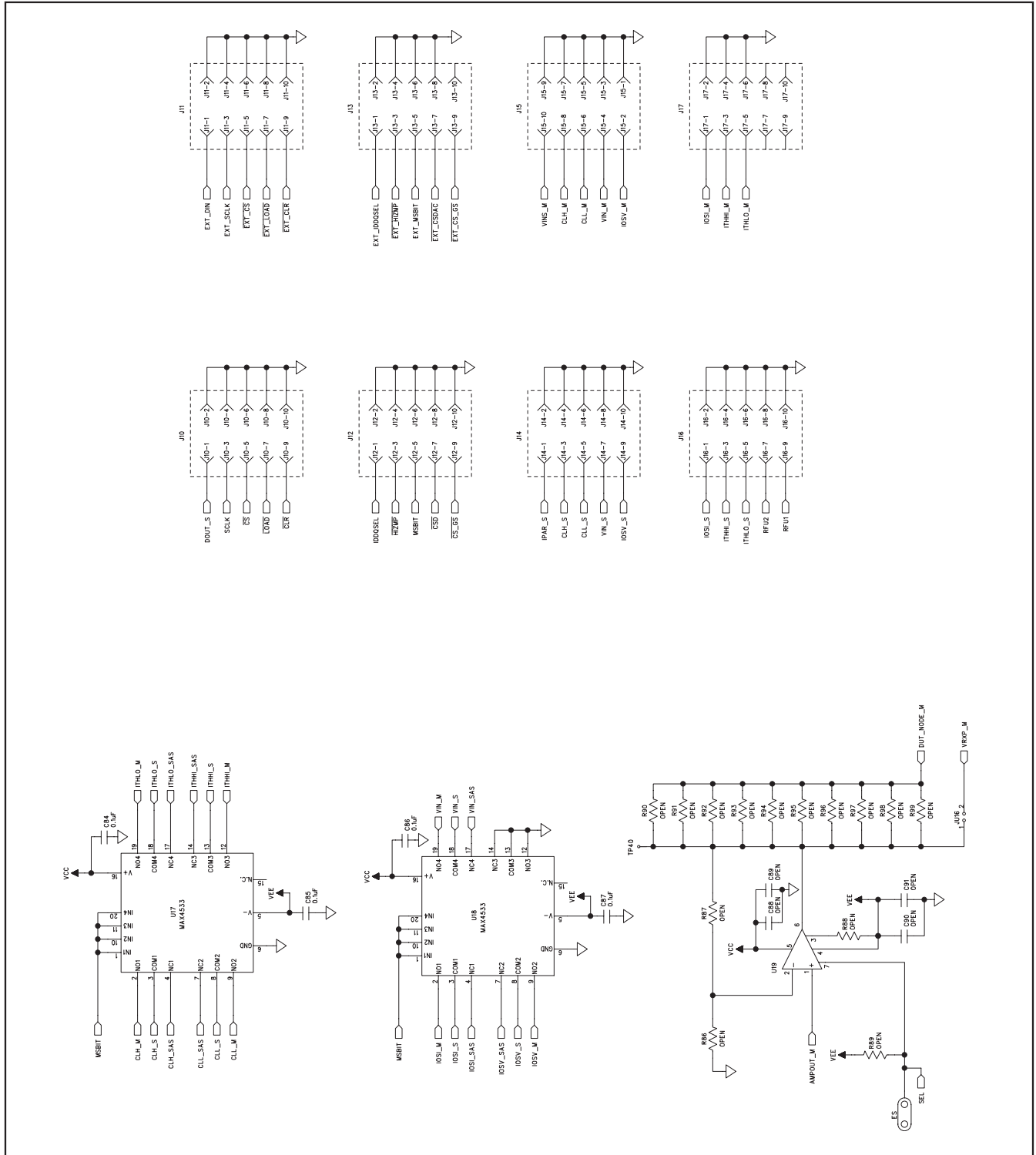

Figure 3h. MAX9959 EV Kit Schematic (Sheet 8 of 8)

# MAX9959 Evaluation Kit

Evaluates: MAX9959

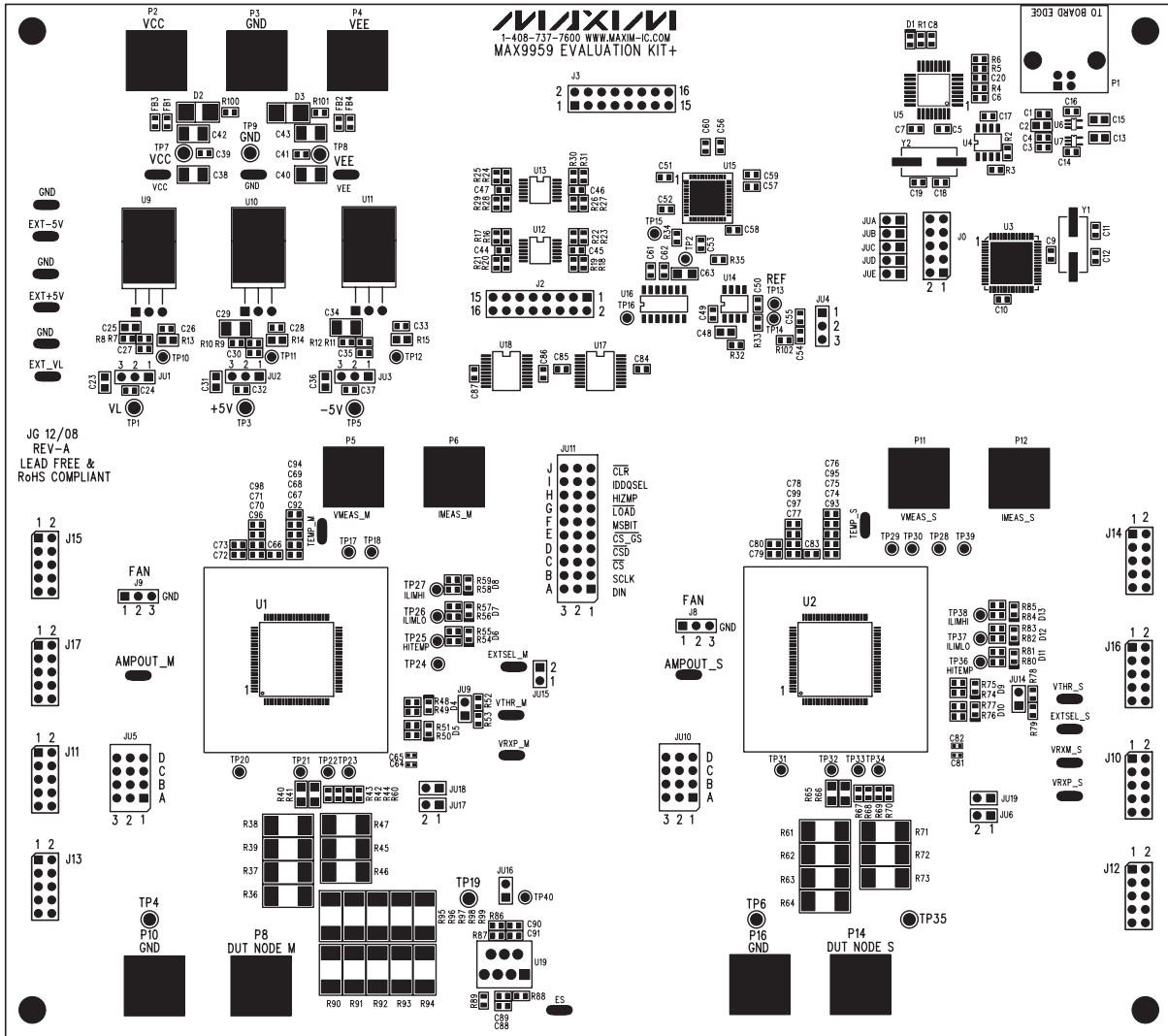

Figure 4. MAX9959 EV Kit Component Placement Guide—Component Side

# MAX9959 Evaluation Kit

Evaluates: MAX9959

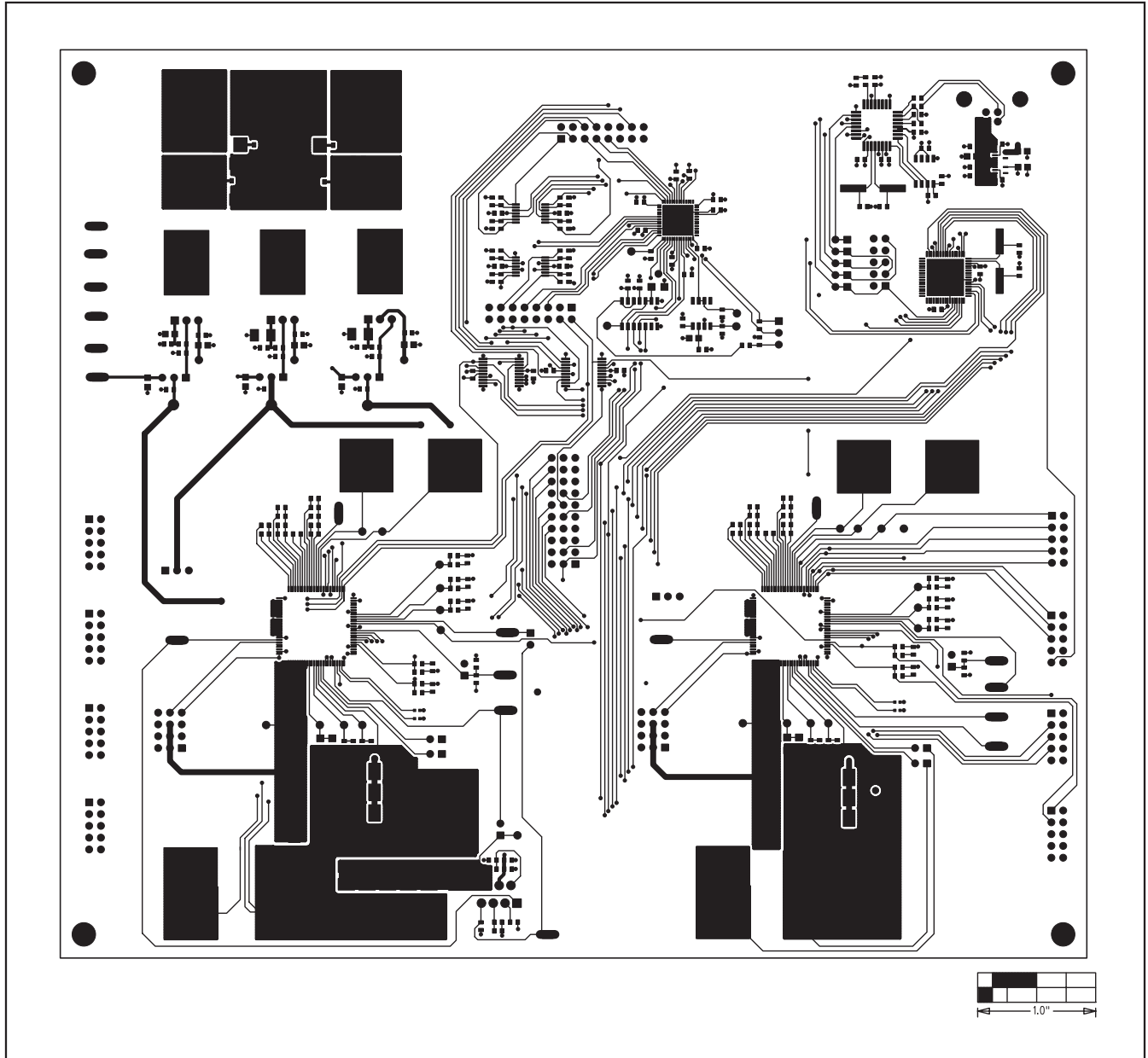

Figure 5. MAX9959 EV Kit PCB Layout—Component Side

# MAX9959 Evaluation Kit

Evaluates: **MAX9959**

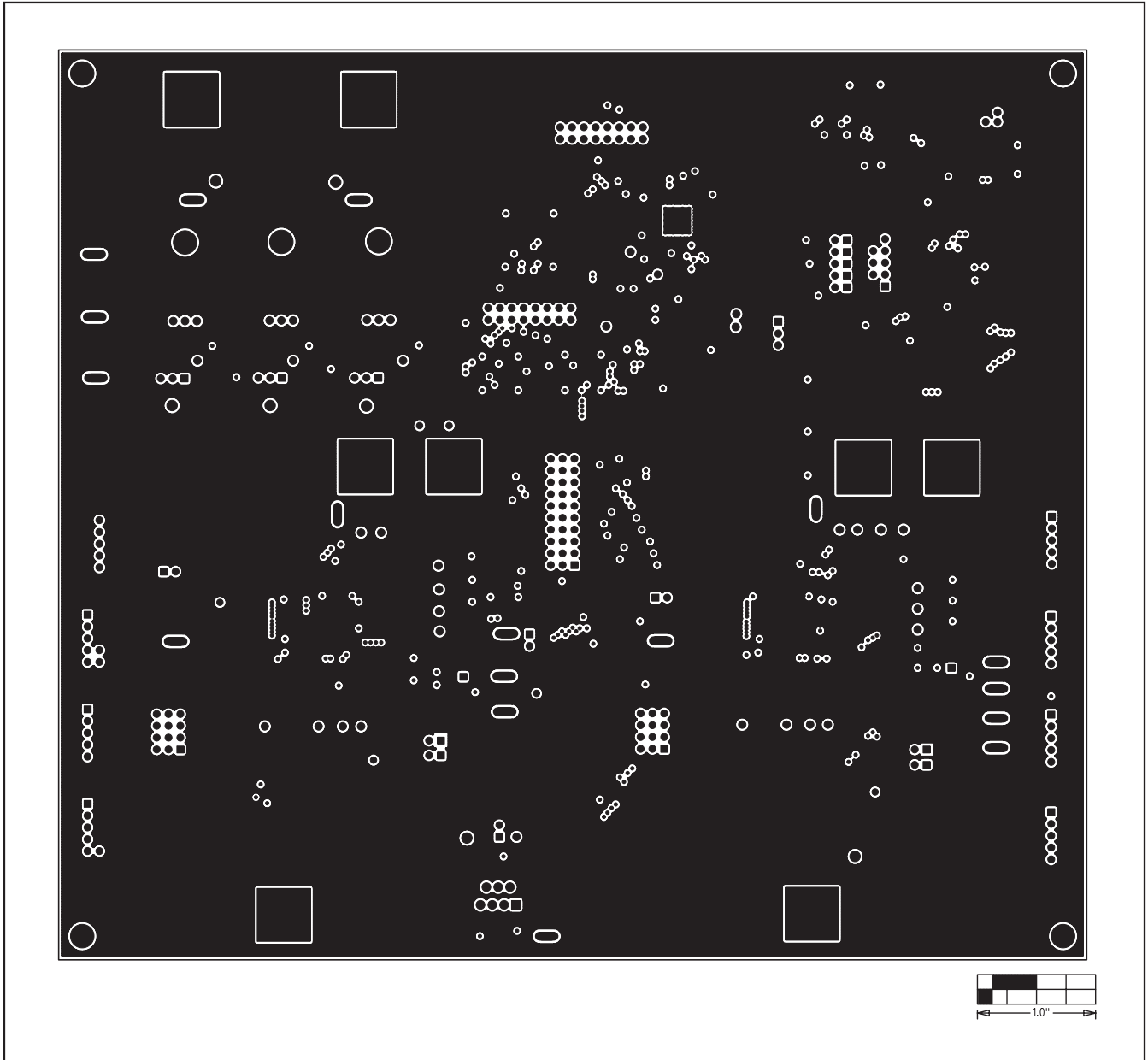

Figure 6. MAX9959 EV Kit PCB Layout—2nd Layer

# MAX9959 Evaluation Kit

Evaluates: MAX9959

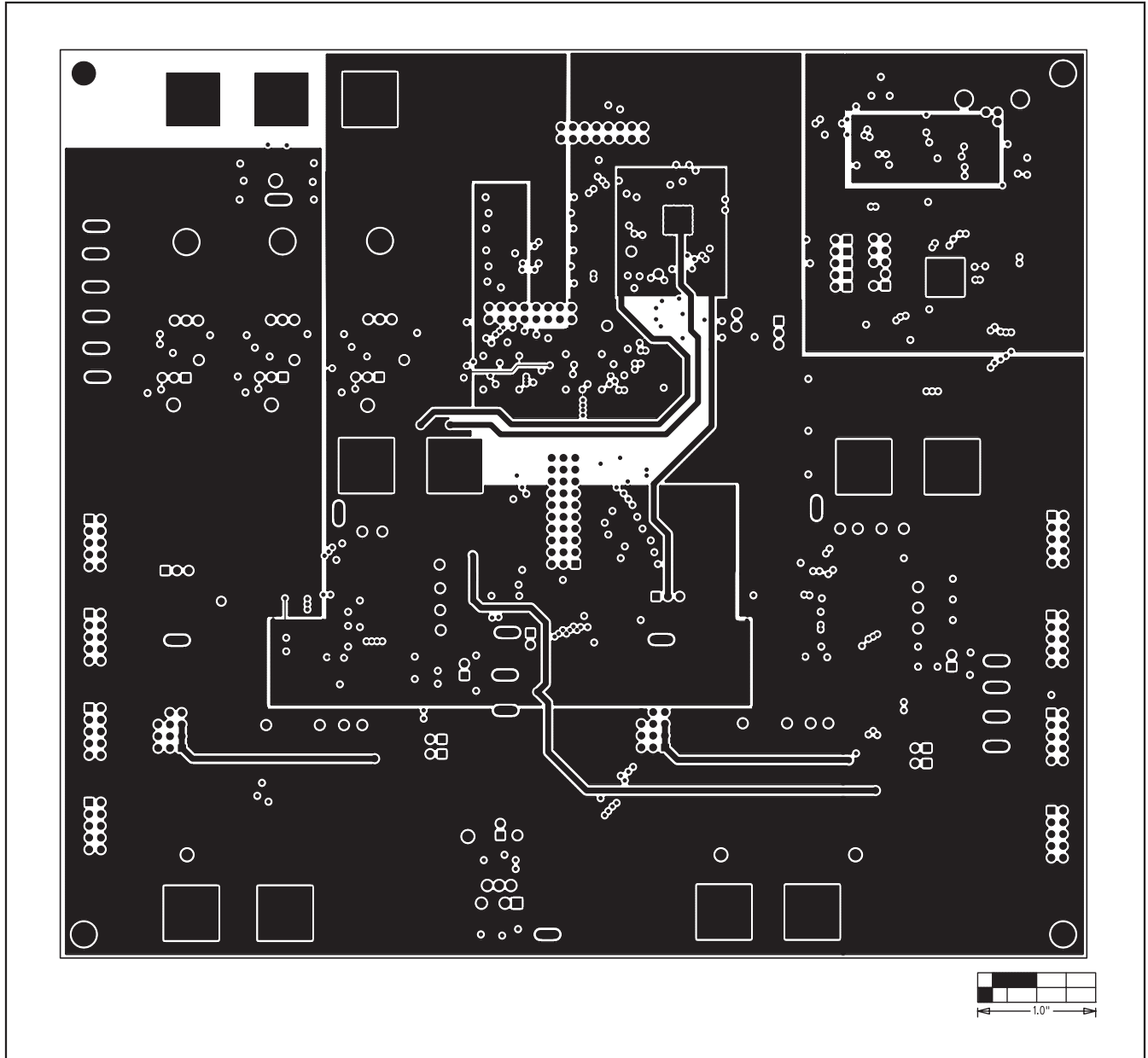

Figure 7. MAX9959 EV Kit PCB Layout—3rd Layer

# MAX9959 Evaluation Kit

Evaluates: **MAX9959**

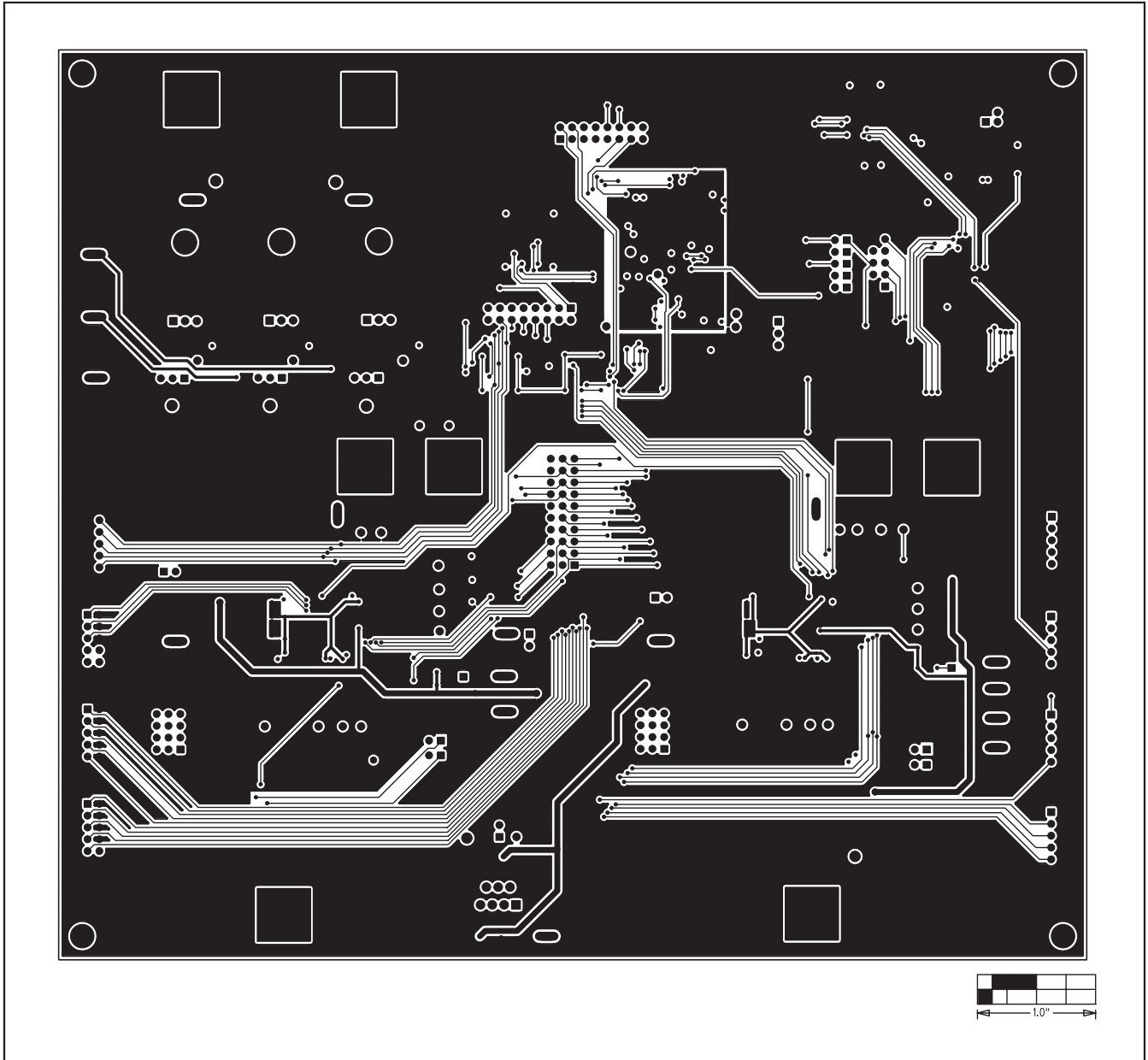

Figure 8. MAX9959 EV Kit PCB Layout—Solder Side

Maxim cannot assume responsibility for use of any circuitry other than circuitry entirely embodied in a Maxim product. No circuit patent licenses are implied. Maxim reserves the right to change the circuitry and specifications without notice at any time.

**Maxim Integrated Products, 120 San Gabriel Drive, Sunnyvale, CA 94086 408-737-7600** \_\_\_\_\_ **23**



Компания «ЭлектроПласт» предлагает заключение долгосрочных отношений при поставках импортных электронных компонентов на взаимовыгодных условиях!

Наши преимущества:

- Оперативные поставки широкого спектра электронных компонентов отечественного и импортного производства напрямую от производителей и с крупнейших мировых складов;
- Поставка более 17-ти миллионов наименований электронных компонентов;
- Поставка сложных, дефицитных, либо снятых с производства позиций;
- Оперативные сроки поставки под заказ (от 5 рабочих дней);
- Экспресс доставка в любую точку России;
- Техническая поддержка проекта, помощь в подборе аналогов, поставка прототипов;
- Система менеджмента качества сертифицирована по Международному стандарту ISO 9001;
- Лицензия ФСБ на осуществление работ с использованием сведений, составляющих государственную тайну;
- Поставка специализированных компонентов (Xilinx, Altera, Analog Devices, Intersil, Interpoint, Microsemi, Aeroflex, Peregrine, Syfer, Eurofarad, Texas Instrument, Miteq, Cobham, E2V, MA-COM, Hittite, Mini-Circuits, General Dynamics и др.);

Помимо этого, одним из направлений компании «ЭлектроПласт» является направление «Источники питания». Мы предлагаем Вам помощь Конструкторского отдела:

- Подбор оптимального решения, техническое обоснование при выборе компонента;
- Подбор аналогов;
- Консультации по применению компонента;
- Поставка образцов и прототипов;
- Техническая поддержка проекта;
- Защита от снятия компонента с производства.



#### Как с нами связаться

**Телефон:** 8 (812) 309 58 32 (многоканальный)

**Факс:** 8 (812) 320-02-42

**Электронная почта:** [org@eplast1.ru](mailto:org@eplast1.ru)

**Адрес:** 198099, г. Санкт-Петербург, ул. Калинина, дом 2, корпус 4, литера А.