

Throttle Position Sensor in Hall Effect Technology Hollow and D-Shaft Versions

FEATURES

- Accurate linearity down to: $\pm 0.5\%$
- Easy mounting principle
- Non contacting technology: Hall effect
- Model dedicated to all applications in harsh environments
- Spring loaded types available
- Material categorization: For definitions of compliance please see www.vishay.com/doc?99912

**RoHS
COMPLIANT**

QUICK REFERENCE DATA	
Sensor type	ROTATIONAL, single turn hall effect
Output type	Wires
Market appliance	Industrial
Dimensions	47 mm x 22 mm

ELECTRICAL SPECIFICATIONS		
PARAMETER	STANDARD	SPECIAL
Electrical angle	90°, 120°, 180°, 270°, 360°	Any other angle upon request
Linearity	$\pm 1\%$	$\pm 0.5\%$
Supply voltage	5 V _{DC} $\pm 10\%$	Other upon request
Supply current	10 mA typical/16 mA max.	16 mA for PWM output
Output signal	Analog ratiometric 10 % to 90 % of V _{supply} or PWM 1 kHz, 10 % to 90 % duty cycle	Other upon request
Over voltage protection	+ 20 V _{DC}	
Reverse voltage protection	- 10 V _{DC}	
Load resistance recommended	Min. 1 k Ω for analog output and PWM output	
Hysteresis static (D-shaft version)	< 0.3°	

MECHANICAL SPECIFICATIONS	
PARAMETER	
Mechanical travel	360° continuous, stops upon request: 124° $\pm 3^\circ$
Bearing type	Sleeve bearing
Standard	IP 50; other on request
Weight	19 g ± 2 g hollow shaft model/22 g ± 2 g D-shaft model

ORDERING INFORMATION/DESCRIPTION									
981HE	0	A	1	W	A	1F16	XXXX	BO 10	e1
MODEL	FEATURES	LINEARITY	ELECTRICAL ANGLE	OUTPUT TYPE	OUTPUT SIGNAL	SHAFT TYPE	SPECIAL REQUEST	PACKAGING	LEAD FINISH
0:	Continuous rotation	A: $\pm 1\%$	1: 90°	W: Wires	A: Analog CW	1: 6.35 mm		Box of 10 pieces	
1:	Mechanical stops	B: $\pm 0.5\%$	2: 180°	Z: Custom	B: Analog CCW	9: Special			
2:	Spring return CW		3: 270°		C: PWM CW	P: Plain			
3:	Spring return CCW		4: 360°		D: PWM CCW	F: Flatted			
			5: 120°		Z: Other output	S: Slotted			
			9: Other angles			Z: Other type			
						Shaft length from mounting face (standard: 16 mm)			
						8H00 hollow shaft			
						8H01 hollow D-shaft			

SAP PART NUMBERING GUIDELINES							
981HE	1	B	9	Z	C	8H01	XXXX
MODEL	MECHANICAL FEATURES	LINEARITY	ELECTRICAL ANGLE	OUTPUT TYPE	OUTPUT SIGNAL	SHAFT TYPE	SPECIAL REQUEST



V_{OUT} ANALOG

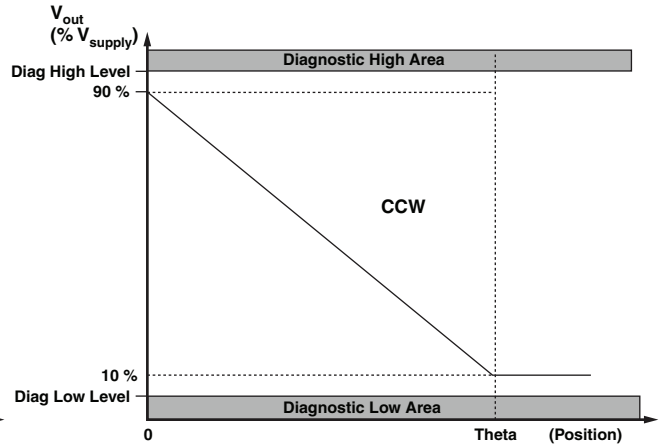
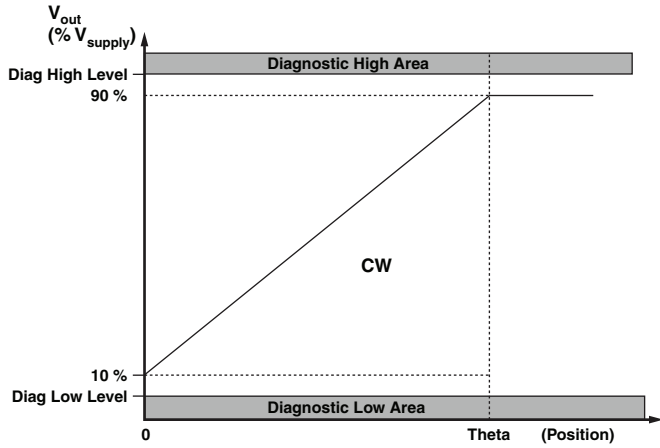

V_{OUT} PWM



DIAGNOSTIC MODES			
FAILURE	V_{out} ANALOG R_{pull-up}	V_{out} ANALOG R_{pull-down}	V_{out} PWM R_{pull-up} = 1 kΩ V_{pull-up} = V_{supply} = 5 V
1: Broken GND	Diagnostic high area	Diagnostic low area	> 97 % V _{supply} without modulation
2: Broken V _{out}	Diagnostic high area	Diagnostic low area	> 97 % V _{supply} without modulation
3: Broken V _{supply}	Diagnostic high area	Diagnostic low area	> 97 % V _{supply} without modulation
Over voltage V _{supply} > 7 V	Diagnostic high area	Diagnostic low area	> 97 % V _{supply} without modulation
Under voltage V _{supply} < 2.7 V	Diagnostic high area	Diagnostic low area	> 97 % V _{supply} without modulation

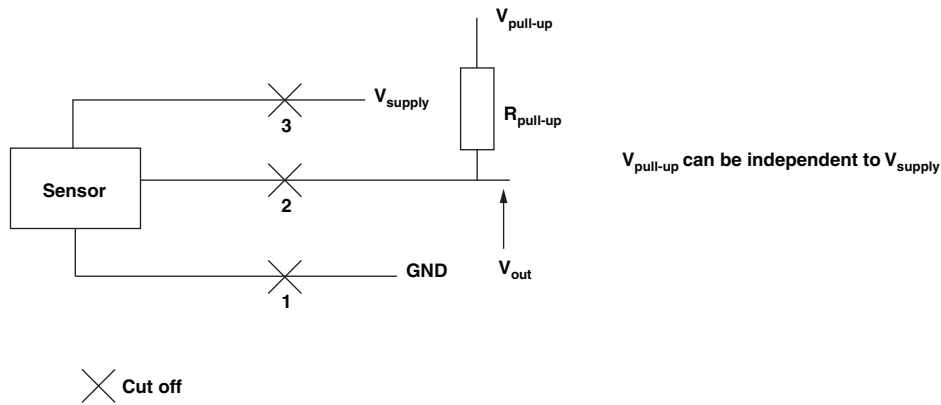

ENVIRONMENTAL SPECIFICATIONS	
Vibrations	20 g from 10 Hz to 2000 Hz, EN 60068-2-6
Shocks	3 shocks/axis; 50 g half a sine 11 ms, EN 60068-2-7
Operating temperature range	- 45 °C to+ 125 °C
Life (in cycles)	> 5M for hollow shaft model/> 10M for D-shaft model
Rotational speed (max.)	120 rpm
Immunity to radiated electromagnetic disturbances	200 V/m 150 kHz/1 GHz, IEC 62132-2 part 2 (level A)
Immunity to power frequency magnetic field	200 A/m 50 Hz/60 Hz, EN 61000-4-8 (level A)
Radiated electromagnetic emissions	30 MHz/1 GHz < 30 dBμV/m, EN 61000-6-4 (level A)
Electrostatic discharges	Contact discharges: ± 8 kV Air discharges: ± 15 kV, EN 61000-4-2
MATERIALS	
Housing	Thermoplastic housing
Shaft	Stainless steel
Output	3 lead wires



DIMENSIONS in millimeters

**VARIOUS POSSIBLE TYPES OF MODEL 981 HE
IN D-SHAFT VERSION**

① 981 HE D-Shaft
Spring return CCW
Shaft: \varnothing 6.35 flatted length 16 mm FMF
Model: 981HE-3-x-x-W-x-1F16

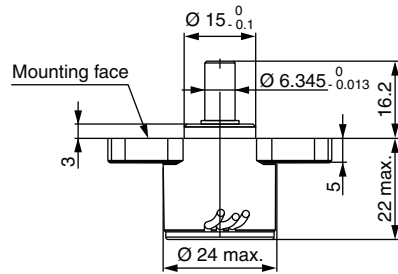
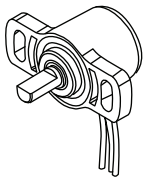

② 981 HE D-Shaft
Spring return CW
Shaft: \varnothing 6.35 flatted 16 mm FMF
Model: 981HE-2-x-x-W-x-1F16

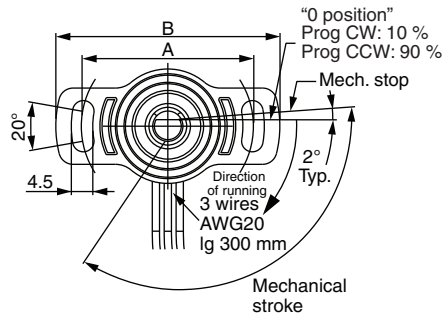
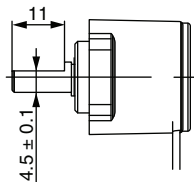
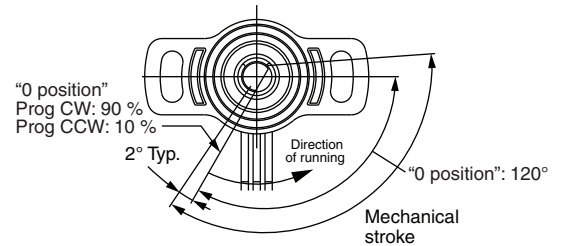

③ 981 HE D-Shaft
Continuous rotation
Shaft: \varnothing 6.35 flatted 16 mm FMF
Model: 981HE-0-x-x-W-x-1F16

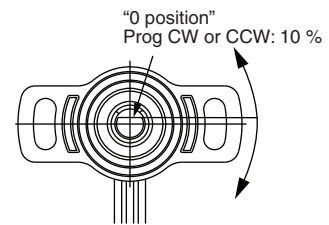

Dimension	Standard	Option	Wires
A	36	38	Yellow GND (-) Red Signal
B	47	48	Green V _{CC} (+)



DIMENSIONS in millimeters

VARIOUS POSSIBLE TYPES OF MODEL 981 HE IN HOLLOW SHAFT VERSION

④ 981 HE Hollow shaft Spring return CCW Shaft: Ø 8 Model: 981HE-3-x-x-W-x-8H00

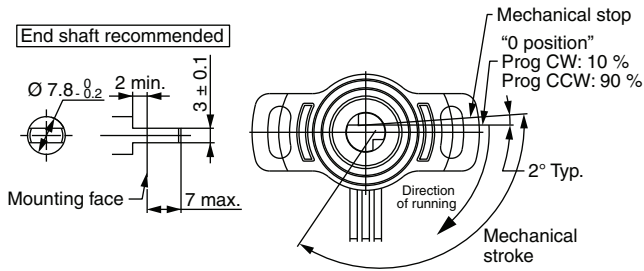

⑥ 981 HE Hollow D-Shaft Continuous rotation Shaft: Ø 8 Model: 981HE-0-x-x-W-x-8H01

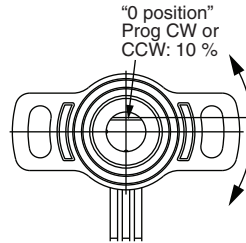

⑦ 981 HE Hollow D-Shaft CW Shaft: Ø 8 Model: 981HE-1-x-x-W-x-8H01

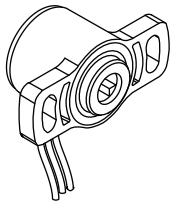
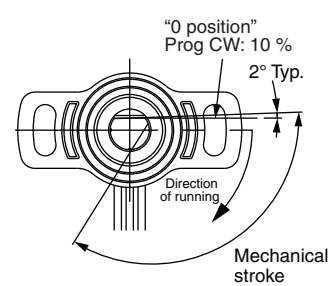

⑤ 981 HE Hollow shaft Spring return CW Shaft: Ø 8 Model: 981HE-2-x-x-W-x-8H00

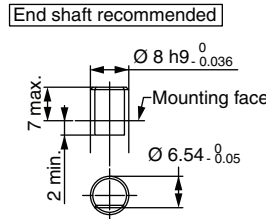
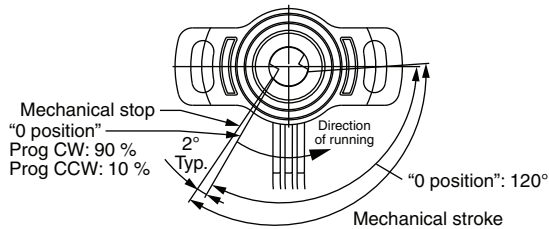

⑧ 981 HE Hollow D-Shaft CCW Shaft: Ø 8 Model: 981HE-1-x-x-W-x-8H01

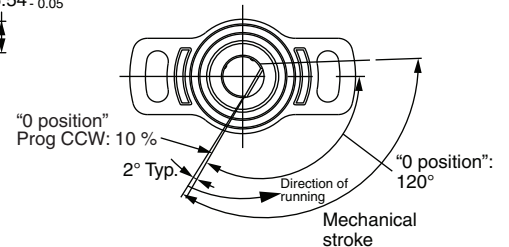



Disclaimer

ALL PRODUCT, PRODUCT SPECIFICATIONS AND DATA ARE SUBJECT TO CHANGE WITHOUT NOTICE TO IMPROVE RELIABILITY, FUNCTION OR DESIGN OR OTHERWISE.

Vishay Intertechnology, Inc., its affiliates, agents, and employees, and all persons acting on its or their behalf (collectively, "Vishay"), disclaim any and all liability for any errors, inaccuracies or incompleteness contained in any datasheet or in any other disclosure relating to any product.

Vishay makes no warranty, representation or guarantee regarding the suitability of the products for any particular purpose or the continuing production of any product. To the maximum extent permitted by applicable law, Vishay disclaims (i) any and all liability arising out of the application or use of any product, (ii) any and all liability, including without limitation special, consequential or incidental damages, and (iii) any and all implied warranties, including warranties of fitness for particular purpose, non-infringement and merchantability.

Statements regarding the suitability of products for certain types of applications are based on Vishay's knowledge of typical requirements that are often placed on Vishay products in generic applications. Such statements are not binding statements about the suitability of products for a particular application. It is the customer's responsibility to validate that a particular product with the properties described in the product specification is suitable for use in a particular application. Parameters provided in datasheets and/or specifications may vary in different applications and performance may vary over time. All operating parameters, including typical parameters, must be validated for each customer application by the customer's technical experts. Product specifications do not expand or otherwise modify Vishay's terms and conditions of purchase, including but not limited to the warranty expressed therein.

Except as expressly indicated in writing, Vishay products are not designed for use in medical, life-saving, or life-sustaining applications or for any other application in which the failure of the Vishay product could result in personal injury or death. Customers using or selling Vishay products not expressly indicated for use in such applications do so at their own risk. Please contact authorized Vishay personnel to obtain written terms and conditions regarding products designed for such applications.

No license, express or implied, by estoppel or otherwise, to any intellectual property rights is granted by this document or by any conduct of Vishay. Product names and markings noted herein may be trademarks of their respective owners.

Material Category Policy

Vishay Intertechnology, Inc. hereby certifies that all its products that are identified as RoHS-Compliant fulfill the definitions and restrictions defined under Directive 2011/65/EU of The European Parliament and of the Council of June 8, 2011 on the restriction of the use of certain hazardous substances in electrical and electronic equipment (EEE) - recast, unless otherwise specified as non-compliant.

Please note that some Vishay documentation may still make reference to RoHS Directive 2002/95/EC. We confirm that all the products identified as being compliant to Directive 2002/95/EC conform to Directive 2011/65/EU.

Vishay Intertechnology, Inc. hereby certifies that all its products that are identified as Halogen-Free follow Halogen-Free requirements as per JEDEC JS709A standards. Please note that some Vishay documentation may still make reference to the IEC 61249-2-21 definition. We confirm that all the products identified as being compliant to IEC 61249-2-21 conform to JEDEC JS709A standards.



Компания «ЭлектроПласт» предлагает заключение долгосрочных отношений при поставках импортных электронных компонентов на взаимовыгодных условиях!

Наши преимущества:

- Оперативные поставки широкого спектра электронных компонентов отечественного и импортного производства напрямую от производителей и с крупнейших мировых складов;
- Поставка более 17-ти миллионов наименований электронных компонентов;
- Поставка сложных, дефицитных, либо снятых с производства позиций;
- Оперативные сроки поставки под заказ (от 5 рабочих дней);
- Экспресс доставка в любую точку России;
- Техническая поддержка проекта, помощь в подборе аналогов, поставка прототипов;
- Система менеджмента качества сертифицирована по Международному стандарту ISO 9001;
- Лицензия ФСБ на осуществление работ с использованием сведений, составляющих государственную тайну;
- Поставка специализированных компонентов (Xilinx, Altera, Analog Devices, Intersil, Interpoint, Microsemi, Aeroflex, Peregrine, Syfer, Eurofarad, Texas Instrument, Miteq, Cobham, E2V, MA-COM, Hittite, Mini-Circuits, General Dynamics и др.);

Помимо этого, одним из направлений компании «ЭлектроПласт» является направление «Источники питания». Мы предлагаем Вам помощь Конструкторского отдела:

- Подбор оптимального решения, техническое обоснование при выборе компонента;
- Подбор аналогов;
- Консультации по применению компонента;
- Поставка образцов и прототипов;
- Техническая поддержка проекта;
- Защита от снятия компонента с производства.



Как с нами связаться

Телефон: 8 (812) 309 58 32 (многоканальный)

Факс: 8 (812) 320-02-42

Электронная почта: org@eplast1.ru

Адрес: 198099, г. Санкт-Петербург, ул. Калинина, дом 2, корпус 4, литера А.