

MILLIPACS® HM

2.0 mm Hard Metric Interconnection System



Millipacs® HM



Created in 1989, FCI - an Areva Group company - rapidly secured its place among the world's top three manufacturers of connectors and interconnect systems. With a turnover of 1.8 billion dollars in 2001, FCI currently operates in 29 countries where it covers the following markets: communications, data, consumer, industrial, military, aerospace, automotive and electrical power interconnect. The company employs 16,000 staff worldwide.

For more information, visit the website at www.fciconnect.com

FCI reserves the right to make any engineering refinements, alterations or improvements deemed necessary on its products. The dimensions appearing in this catalogue are thus subject to change without notice. When dimensions are critical detailed drawings should be requested.

Content

| | Page |
|---|------|
| Features & benefits | 3 |
| Product range overview | 10 |
| Male connectors | 13 |
| Female connectors | 30 |
| Male Right angle press-Fit connectors | 53 |
| Power Contacts | 65 |
| Coaxial Contacts | 70 |
| Coding devices | 72 |
| Application Tooling | 73 |
| Backplane layout | 81 |
| Part number list | 87 |

Millipacs® HM

Features & benefits

Qualifications

- Designed in accordance with IEC 917 and IEC 61076-4-101.
- Fits DIN 43356 and IEEE 1301 Hard Metric Practice.
- Qualified by Bellcore as defined by GR-1217-CORE, iss. 1, November 1995.
- UL and CSA recognized.

Main features

Millipacs® is a standard 2.0 mm Interconnection System featuring 5 and 8 contacts rows and 2 rows for shielding and grounding.

Millipacs® is a modular system built up by a number of specific types of modules with different functions and features signal modules with up to 200 signal contacts per 50 mm module (in 8 row versions) as well as hybrid modules for power, coax and/or FO contacts.

It provides 3 mating levels with 1.5 mm in between and a 2,5 mm wiping length for the shortest contact.

Both headers and receptacles are equipped with the well known FCI "eye of the needle" press-fit section for stable and reliable connections in the boards.

Misalignment of up to 2.5 mm and inclinations of 2° in both directions can be overcome.

FCI's unique 1 piece female concept offers the most solid and reliable Hard Metric connector to the market. FCI is also offering the most versatile shielding solutions on their female concept: no shielding, top shielding, top and semi-rear shielding* or fully shielded modules are all standard available. Male modules are aligned next to each other without loss of contact positions and integrated edge polarization does guarantee a correct positioning of the different modules on the board. Module types without guiding features (type B and E) are to be used in between modules with the integrated guiding areas only.

Small pin sizes and related small PT hole diameters both at backplane and component board level guarantee that conventional PCB routing, manufacturing and component assembly can still be used. Maximum wiring density (up to 3 tracks in between 2 holes) can be achieved while no additional layers are required.

* on request

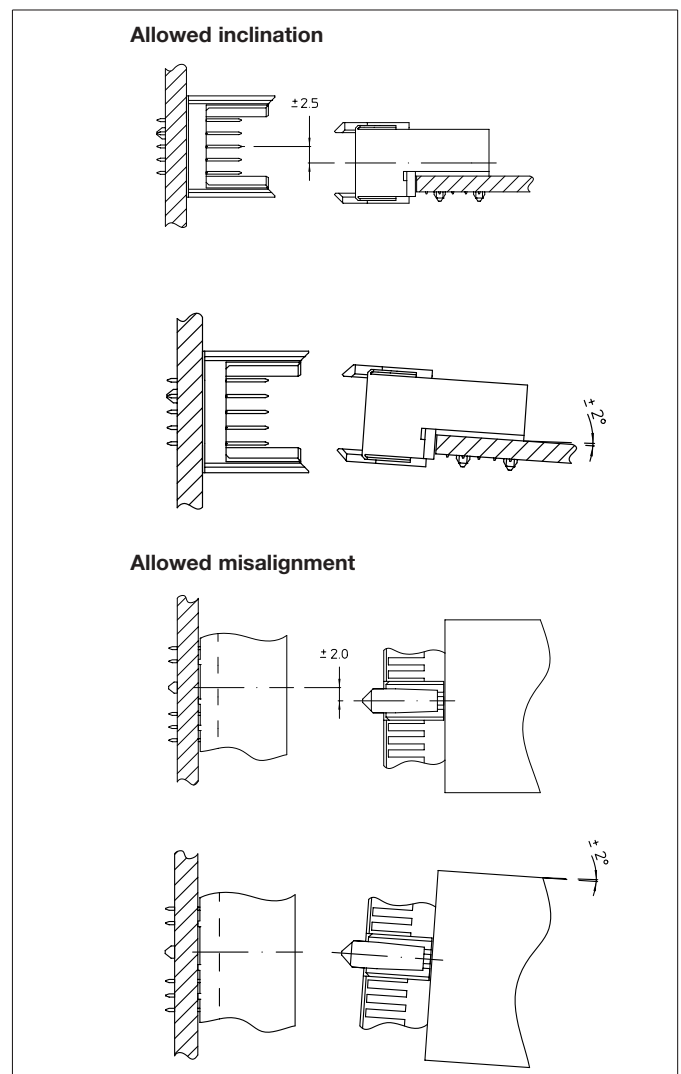

Millipacs® HM

Built-in dimensions



Contacts overview



Signal contacts mating levels

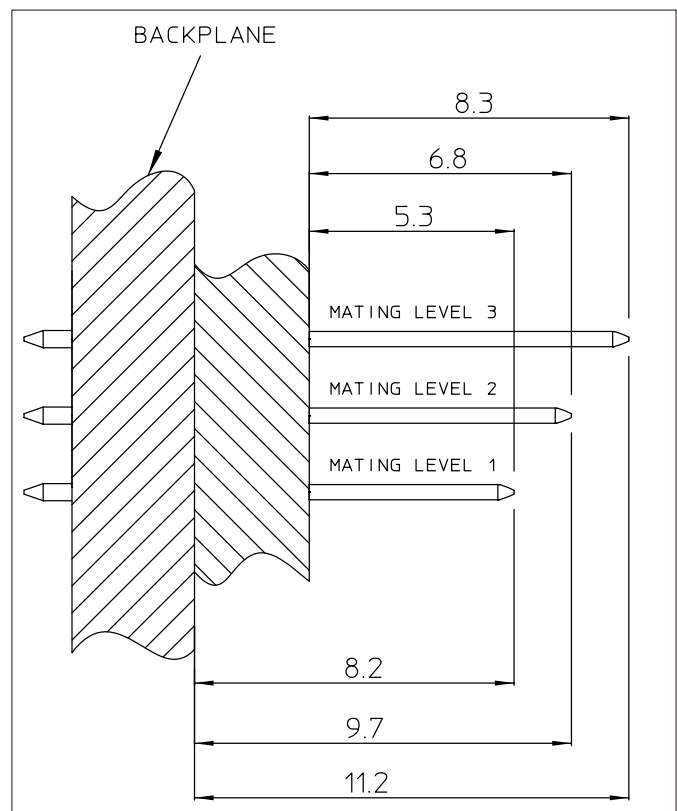



Millipacs[®] HM

Customer Request Form for special loading

Description

This chart can be used to fill in a specific contact pin configuration for your application. An overview of the existing pins (with the corresponding code to be filled in) is listed on page 4. Please, leave unfilled positions blank.

Note : Check on the FCI website to download the customer request form.

Connector type (circle corresponding letter):
A, B, B22, B19, AB, AB22, AB19, C, CR, D, DE, E, F, FR, M

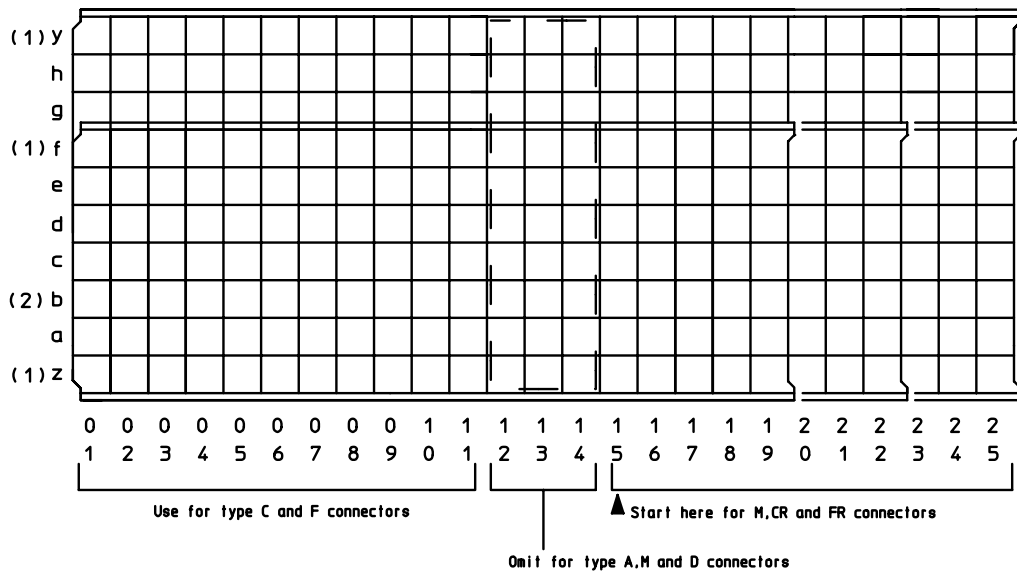

NOTES

- (1) Ground return shield contacts only, mating level 3 required.
z+F for 5+2 row connector, z+y for 8+2 row connector.
- (2) No level 3 contacts allowed when mating with right angle female connector

Name : _____
 Company : _____
 Address : _____

 Phone : _____
 Fax : _____
 E-mail : _____

Performance level : 1 2 3
 Remarks : _____

Millipacs® HM

Features and benefits

High speed signal transmission

With modern electronic devices, higher bitrates require improved electrical performance of all components in terms of signal transmission. As a consequence, all picosecond-system designers should anticipate the need to control the impedance and cross talk.

In order to accommodate you with a high speed interconnection system, the high frequency characteristics such as reflection, rise time degradation and cross talk (forward and backward) are measured and simulated for different signal-to-ground configurations of the Millipacs® system.

A high accuracy is needed to characterize the connectors over a wide bandwidth or over a large range of rise times. The measurement set-up is shown in figure 1.

FCI's R&D specialists are available to help to define the best installed cost solution in terms of your specific High Speed requirements. A complete set of reports is available on request.

As an example, the results for a differential pin configuration on a 5 rows 2 mm grid Millipacs® backplane connector (figure 2) are presented.



Fig.1 : Test set-up for high-frequency characterization of the Millipacs® backplane connectors

| | | | | | |
|-------|----|----|----|----|----|
| row E | S+ | S+ | S+ | S+ | S+ |
| row D | S- | S- | S- | S- | S- |
| row C | G | G | G | G | G |
| row B | S+ | S+ | S+ | S+ | S+ |
| row A | S- | S- | S- | S- | S- |

Fig.2 : Differential pin configuration (G=ground; S=signal)

Millipacs[®] HM

Figures 3 and 4 respectively show for pin pairs on rows A-B and D-E, the reflection and rise time degradation of the odd mode as a function of rise time. At larger rise times the reflection curves converge to 0%, because the transmission line behavior of the pins disappears at lower frequencies. At the lower rise times, the reflection coefficient still stays below 20%.

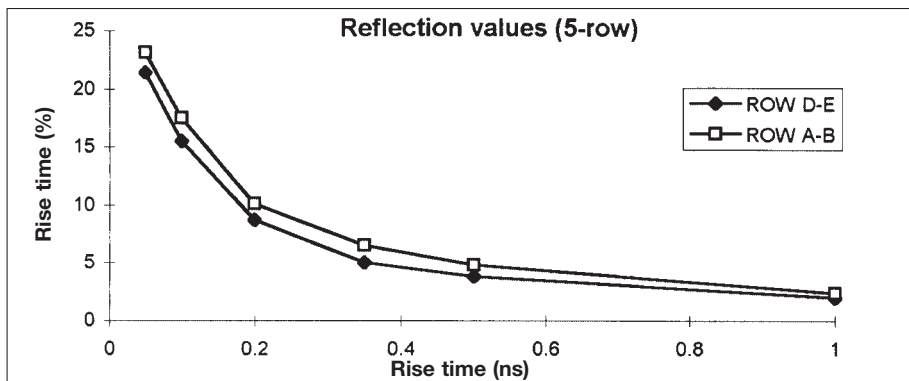

Fig.3 : Reflection values for the odd mode of pin pairs A-B and D-E as function of rise time

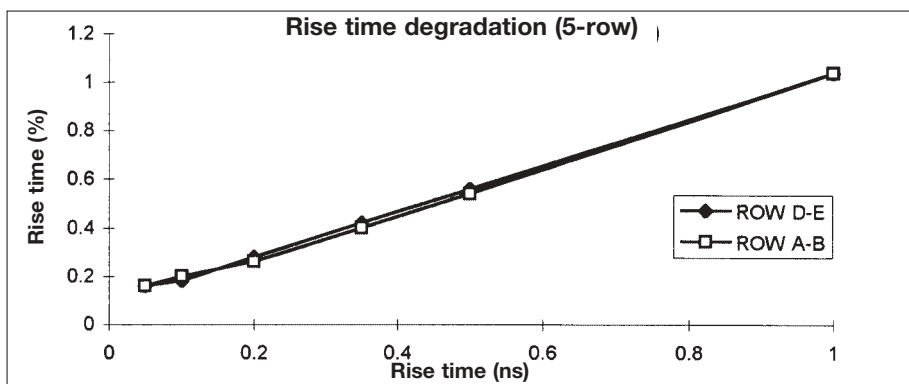

Fig.4 : Rise time degradation for the odd mode of pin pairs A-B and D-E as function of rise time

Figures 5 and 6 show the multi-line forward, respectively backward cross talk on the same pin pairs A-B and D-E i.e. the differential signal at the far- and the near-end of these pairs, when the neighboring pin pairs are excited in phase with differential signals. These worst case results show that for a rise time of 350 ps, the forward crosstalk is less than 2% and the backward crosstalk is about 10%.

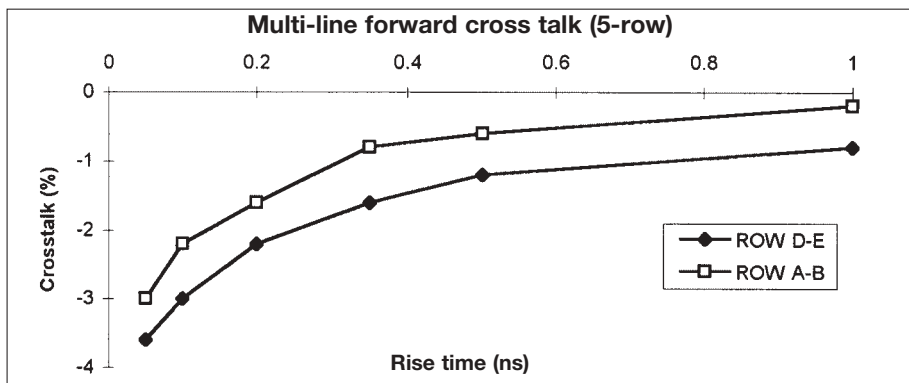

Fig.5 : Multi-line forward cross talk on pairs A-B and D-E as function of rise time

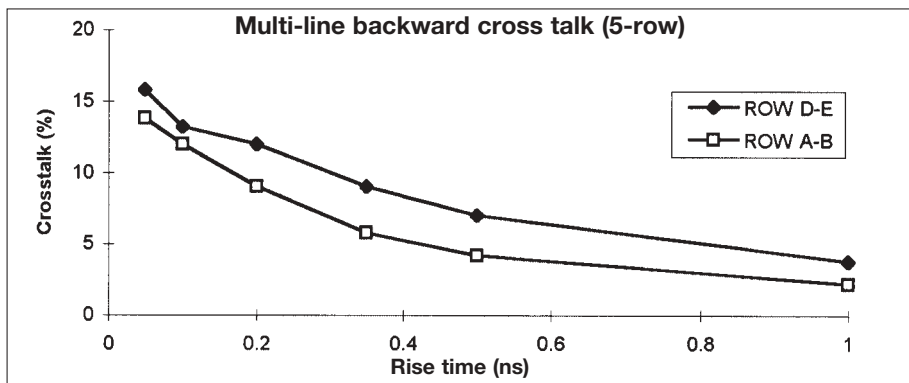

Fig.6 : Multi-line backward cross talk on pairs A-B and D-E as function of rise time

Millipacs® HM

Features and benefits

Shielding performance

With the increasing coverage of the electromagnetic spectra and the constantly increasing use of electronic hardware, the need for control on electromagnetic interference is one of the main issues in modern system design. As a result, the Millipacs® connector system is anticipated with a complete range of shielding possibilities.

In order to evaluate the shielding performance of the Millipacs® connector a measurement set-up was designed based on a triaxial set-up (figure 7), formed by an innerline (the connector with his shield) and an outerline (the shielding with an external conductor). One of these transmission line structures is used to forge a current on the shield, the opposite is a sense line to detect the induced fields.

Shielding effectiveness is a functional method to characterize the shield leakage, since it offers us the relation between the measured power progressing from shielding leakage and the reference power delivered to the test-cel.

Figure 8 displays the shielding effectiveness of the non-shielded Millipacs® backpanel connector. As can be noticed, the shielding effectiveness is improved approx. 35 dB at higher frequencies (3 GHz) when shielding is introduced.



Fig.7 : Triaxial test cel

$$S.E.(dB)=10 \log \left(\frac{P_{leakage}}{P_{ref}} \right)$$

Formula 1 : Shielding effectiveness

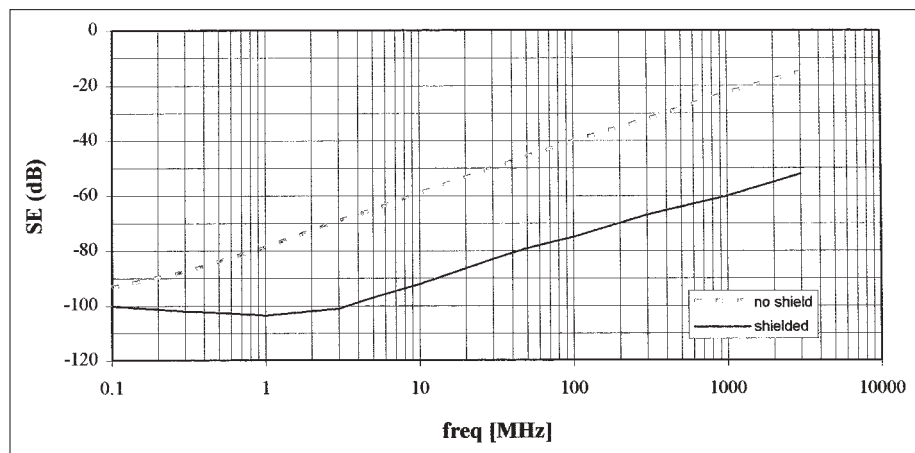

Fig.8 : Shielding effectiveness of the shielded and non-shielded version

Millipacs® HM

Male and female modules

Description

Connector modules with 5 (+2) or 8 (+2) row contact arrangement on a pitch of 2.0 mm featuring high density, shielding and high speed in a Hard Metric configuration.

Performance characteristics

| | |
|-------------------------|--|
| Operating temperature : | -55°C to +125°C |
| Operating current* | :1.5 A at 20°C 1.0 A at 70°C |
| Test voltage* | :750 Vrms |
| Contact resistance | :20 mΩ max |
| Insulation resistance | :10 ⁴ MΩ min |
| Mating force | :0.75 N max per contact pair |
| Withdrawal force | :0.15 N min per contact pair |
| Hertz stress | :200 Kpsi min |
| Misalignment | :Longitudinal ±2.0 mm Transversal ±2.5 mm |
| Inclination | :±2.0° |



| | |
|---------------------------|---|
| 3 Contact levels | :5.30 mm 6.80 mm 8.30 mm |
| Normal force | :0.75 N min (EOL) |
| Creepage and clearance* : | 0.6 mm min (free modules) 0.8 mm min (fixed modules) |

* Fully loaded

Construction

| | |
|--------------------|--|
| Insulator material | :high temperature thermoplastic UL94V0 |
| Contact material | :phosphor bronze |
| Contact plating | :selective Au over Ni on mating areas SnPb over Ni on press-fit and IDC areas |

Performance levels :* Front mating contacts (termination C,D)

| Performance level | Mating cycles | Plating code |
|-------------------|---------------|--------------|
| 3 | 50 | Z1 |
| 2 | 250 | N9 |
| 1 | 500 | E9 |

Front + rear mating contacts (termination K,M and N)

| Performance level | Mating cycles | Plating code |
|-------------------|---------------|--------------|
| 3 | 50 | GC |
| 2 | 250 | GF |
| 1 | 500 | GL |

* Bellcore & Telcordia compliant plating and lubrication available. Please contact FCI for details.

Millipacs® HM

Product range overview



Type A connectors

- 50 mm module.
- 110 signal contacts.
- With “MP” multi-purpose center for polarization, pre-guiding and coding.
- Non-shielded and shielded versions.



Type B connectors

- 38, 44 or 50 mm module.
- 95, 110 or 125 signal contacts.
- Non-shielded and shielded versions.



Type AB connectors

- 38, 44 or 50 mm module.
- 95, 110 or 125 signal contacts.
- With extra guiding pegs for polarization and pre-guiding.
- Non-shielded and shielded versions.



Type C connectors

- 25 mm module.
- 55 signal contacts.
- End position modules .
- With “MP” multi-purpose center for polarization and pre-guiding.
- Non-shielded and shielded versions.



Type CR connectors

- 25 mm reversed C module.
- 55 signal contacts.
- Begin position modules.
- With “MP” multi-purpose center for polarization and pre-guiding.
- Non-shielded and shielded versions.

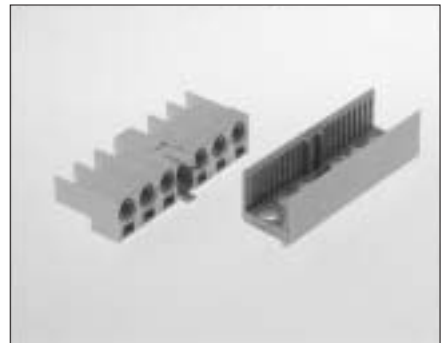

Type L connectors

- 50 mm module.
- 6 special contact cavities.
- With “MP” multi-purpose center for polarization, pre-guiding and coding.

Millipacs® HM



Type M connectors

- 50 mm module.
- 3 special contact cavities and 55 signal contacts.
- With “MP” multi-purpose center for polarization, pre-guiding and coding.
- Non-shielded and shielded versions.



Type N connectors

- 25 mm module.
- 3 special contact cavities.
- End position modules only.
- With “MP” multi-purpose center for polarization and pre-guiding.



Type D connectors

- 50 mm module.
- 176 signal contacts.
- With “MP” multi-purpose center for polarization, pre-guiding and coding.
- Reduced PCB space.
- Additional guiding area.
- Non-shielded and shielded versions.



Type DE connectors

- 50 mm module.
- 200 signal contacts.
- Reduced PCB space.
- Non-shielded and shielded versions.
- With extra guiding pegs for polarization and pre-guiding.



Type E connectors

- 50 mm module.
- 200 signal contacts.
- Reduced PCB space.
- Non-shielded and shielded versions.



Type F connectors

- 25 mm module.
- 88 signal contacts.
- Reduced PCB space.
- End position modules .
- With “MP” multi-purpose center for polarization and pre-guiding.
- Non-shielded and shielded versions.

Millipacs® HM



Type FR connectors

- 25 mm reversed F module.
- 88 signal contacts.
- Reduced PCB space.
- Begin position modules.
- With “MP” multi-purpose center for polarization and pre-guiding.
- Non-shielded and shielded versions.



Straight female modules

- Type A, B and C female straight modules.
- To be mated with normal male header modules.
- Non-shielded and shielded versions.



I/O cable connector modules

- To be mated with rear plug-up shrouds.
- Non-shielded and shielded versions.
- LF and HF versions.
- Moulded-in polarization features.



Pre-assembled power press-fit modules

- Type L, M and N modules.
- Non-shielded and shielded versions.
- Standard and advanced power contacts.



Board to Board shrouds, all types

- 10, 12, 25, 38, 44 and 50 mm modules.
- 5 and 8 row versions.
- Moulded-on spacers.



Male right angle modules

- Type A, B and C.
- Non-shielded and top shielded versions.

Millipacs® HM

5+2 Row male signal straight press-fit-to-board connector : TYPE B

Description

- 5 or 5+2 Row male header with 125 signal contacts.
- Press - fit terminations.
- 3 Mating levels.
- Non - shielded and shielded versions.
- Customized loading arrangements : see page 5.
- Board lay-out : see page 80.

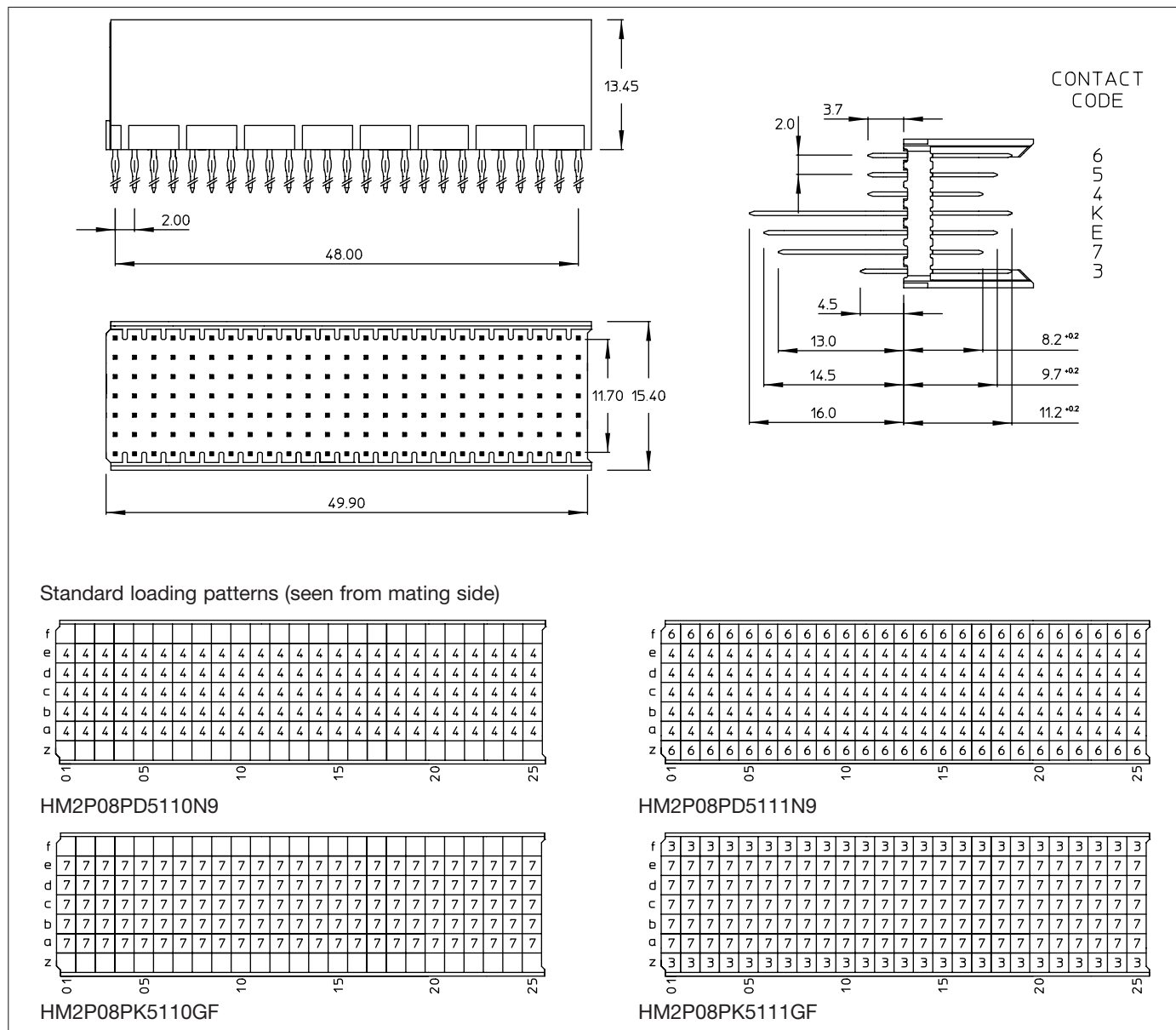
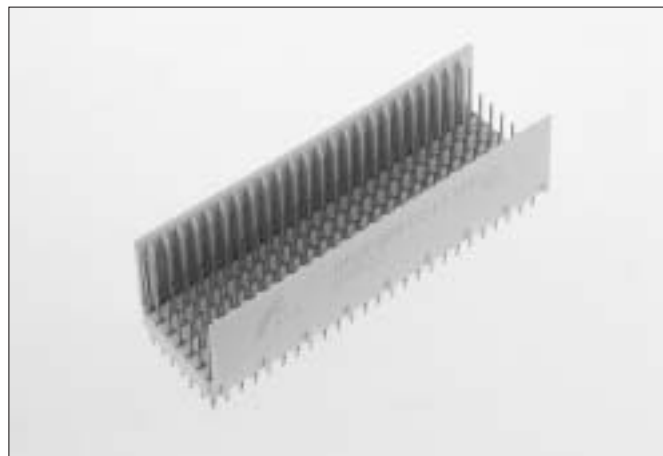

Millipacs® HM

5+2 Row male signal straight press-fit-to-board connector : TYPE B22

Description

- 5 or 5+2 Row male header with 110 signal contacts.
- Press - fit terminations.
- 3 Mating levels.
- Non - shielded and shielded versions.
- Customized loading arrangements : see page 5.
- Board lay-out : see page 80.
- Module also used in CompactPCI; see CompactPCI catalog.

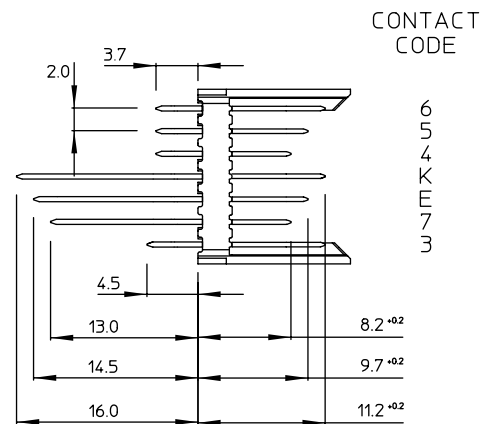
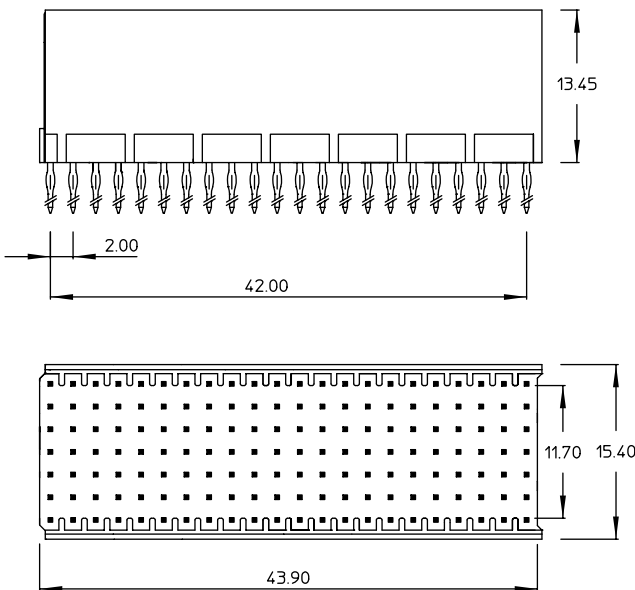
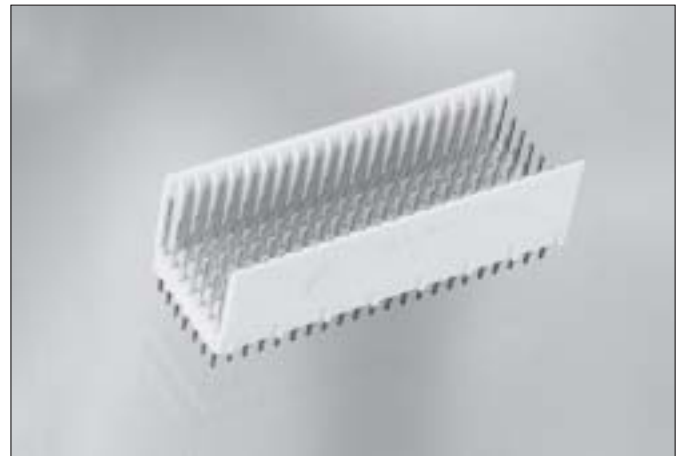

Standard loading patterns (seen from mating side)

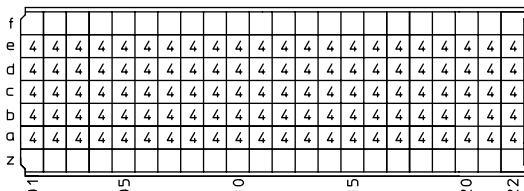

HM2P70PD5110N9

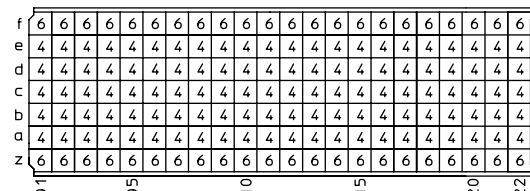

HM2P70PD5111N9

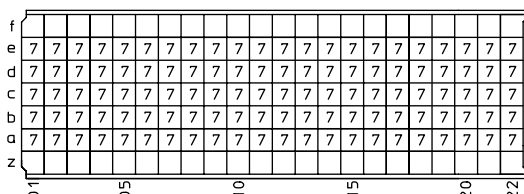

HM2P70PK5110GF

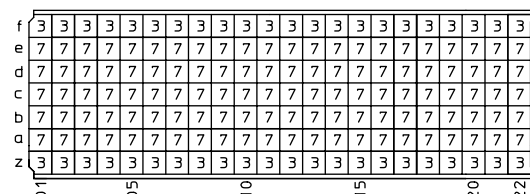

HM2P70PK5111GF

Millipacs® HM

5+2 Row male signal straight press-fit-to-board connector : TYPE B19

Description

- 5 or 5+2 Row male header with 95 signal contacts.
- Press - fit terminations.
- 3 Mating levels.
- Non - shielded and shielded versions.
- Customized loading arrangements : see page 5.
- Board lay-out : see page 80.
- Module also used in CompactPCI; see CompactPCI catalog.

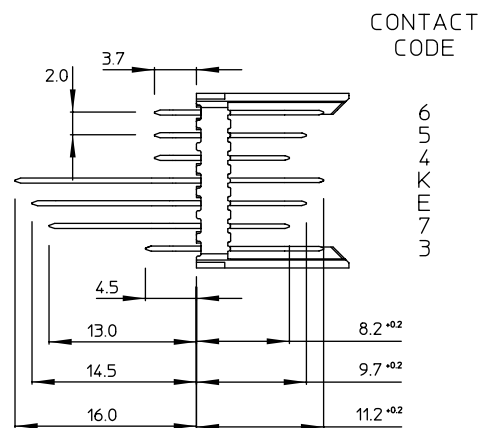
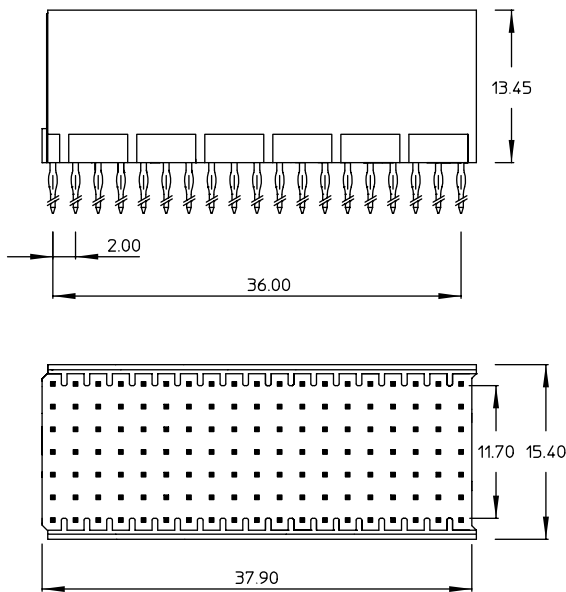
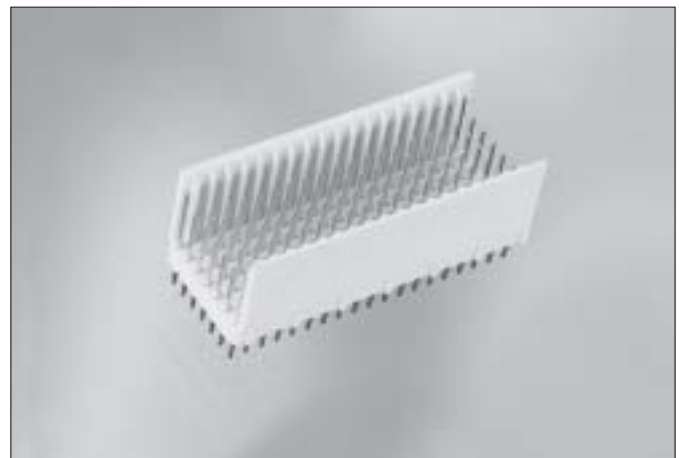

Standard loading patterns (seen from mating side)

| | | | | | | | | | | | | | | | | | | | | | | | | |
|---|---|---|----|----|----|---|---|---|---|---|---|---|---|---|---|---|---|---|---|---|---|---|---|---|
| f | | | | | | | | | | | | | | | | | | | | | | | | |
| e | 4 | 4 | 4 | 4 | 4 | 4 | 4 | 4 | 4 | 4 | 4 | 4 | 4 | 4 | 4 | 4 | 4 | 4 | 4 | 4 | 4 | 4 | 4 | 4 |
| d | 4 | 4 | 4 | 4 | 4 | 4 | 4 | 4 | 4 | 4 | 4 | 4 | 4 | 4 | 4 | 4 | 4 | 4 | 4 | 4 | 4 | 4 | 4 | 4 |
| c | 4 | 4 | 4 | 4 | 4 | 4 | 4 | 4 | 4 | 4 | 4 | 4 | 4 | 4 | 4 | 4 | 4 | 4 | 4 | 4 | 4 | 4 | 4 | 4 |
| b | 4 | 4 | 4 | 4 | 4 | 4 | 4 | 4 | 4 | 4 | 4 | 4 | 4 | 4 | 4 | 4 | 4 | 4 | 4 | 4 | 4 | 4 | 4 | 4 |
| a | 4 | 4 | 4 | 4 | 4 | 4 | 4 | 4 | 4 | 4 | 4 | 4 | 4 | 4 | 4 | 4 | 4 | 4 | 4 | 4 | 4 | 4 | 4 | 4 |
| z | 4 | 4 | 4 | 4 | 4 | 4 | 4 | 4 | 4 | 4 | 4 | 4 | 4 | 4 | 4 | 4 | 4 | 4 | 4 | 4 | 4 | 4 | 4 | 4 |
| | 0 | 5 | 10 | 15 | 19 | | | | | | | | | | | | | | | | | | | |

HM2P71PD5110N9

| | | | | | | | | | | | | | | | | | | | | | | | | |
|---|---|---|----|----|----|---|---|---|---|---|---|---|---|---|---|---|---|---|---|---|---|---|---|---|
| f | 6 | 6 | 6 | 6 | 6 | 6 | 6 | 6 | 6 | 6 | 6 | 6 | 6 | 6 | 6 | 6 | 6 | 6 | 6 | 6 | 6 | 6 | 6 | 6 |
| e | 4 | 4 | 4 | 4 | 4 | 4 | 4 | 4 | 4 | 4 | 4 | 4 | 4 | 4 | 4 | 4 | 4 | 4 | 4 | 4 | 4 | 4 | 4 | 4 |
| d | 4 | 4 | 4 | 4 | 4 | 4 | 4 | 4 | 4 | 4 | 4 | 4 | 4 | 4 | 4 | 4 | 4 | 4 | 4 | 4 | 4 | 4 | 4 | 4 |
| c | 4 | 4 | 4 | 4 | 4 | 4 | 4 | 4 | 4 | 4 | 4 | 4 | 4 | 4 | 4 | 4 | 4 | 4 | 4 | 4 | 4 | 4 | 4 | 4 |
| b | 4 | 4 | 4 | 4 | 4 | 4 | 4 | 4 | 4 | 4 | 4 | 4 | 4 | 4 | 4 | 4 | 4 | 4 | 4 | 4 | 4 | 4 | 4 | 4 |
| a | 4 | 4 | 4 | 4 | 4 | 4 | 4 | 4 | 4 | 4 | 4 | 4 | 4 | 4 | 4 | 4 | 4 | 4 | 4 | 4 | 4 | 4 | 4 | 4 |
| z | 6 | 6 | 6 | 6 | 6 | 6 | 6 | 6 | 6 | 6 | 6 | 6 | 6 | 6 | 6 | 6 | 6 | 6 | 6 | 6 | 6 | 6 | 6 | 6 |
| | 0 | 5 | 10 | 15 | 19 | | | | | | | | | | | | | | | | | | | |

HM2P71PD5111N9

| | | | | | | | | | | | | | | | | | | | | | | | | |
|---|---|---|----|----|----|---|---|---|---|---|---|---|---|---|---|---|---|---|---|---|---|---|---|---|
| f | | | | | | | | | | | | | | | | | | | | | | | | |
| e | 7 | 7 | 7 | 7 | 7 | 7 | 7 | 7 | 7 | 7 | 7 | 7 | 7 | 7 | 7 | 7 | 7 | 7 | 7 | 7 | 7 | 7 | 7 | 7 |
| d | 7 | 7 | 7 | 7 | 7 | 7 | 7 | 7 | 7 | 7 | 7 | 7 | 7 | 7 | 7 | 7 | 7 | 7 | 7 | 7 | 7 | 7 | 7 | 7 |
| c | 7 | 7 | 7 | 7 | 7 | 7 | 7 | 7 | 7 | 7 | 7 | 7 | 7 | 7 | 7 | 7 | 7 | 7 | 7 | 7 | 7 | 7 | 7 | 7 |
| b | 7 | 7 | 7 | 7 | 7 | 7 | 7 | 7 | 7 | 7 | 7 | 7 | 7 | 7 | 7 | 7 | 7 | 7 | 7 | 7 | 7 | 7 | 7 | 7 |
| a | 7 | 7 | 7 | 7 | 7 | 7 | 7 | 7 | 7 | 7 | 7 | 7 | 7 | 7 | 7 | 7 | 7 | 7 | 7 | 7 | 7 | 7 | 7 | 7 |
| z | | | | | | | | | | | | | | | | | | | | | | | | |
| | 0 | 5 | 10 | 15 | 19 | | | | | | | | | | | | | | | | | | | |

HM2P71PK5110GF

| | | | | | | | | | | | | | | | | | | | | | | | | |
|---|---|---|----|----|----|---|---|---|---|---|---|---|---|---|---|---|---|---|---|---|---|---|---|---|
| f | 3 | 3 | 3 | 3 | 3 | 3 | 3 | 3 | 3 | 3 | 3 | 3 | 3 | 3 | 3 | 3 | 3 | 3 | 3 | 3 | 3 | 3 | 3 | 3 |
| e | 7 | 7 | 7 | 7 | 7 | 7 | 7 | 7 | 7 | 7 | 7 | 7 | 7 | 7 | 7 | 7 | 7 | 7 | 7 | 7 | 7 | 7 | 7 | 7 |
| d | 7 | 7 | 7 | 7 | 7 | 7 | 7 | 7 | 7 | 7 | 7 | 7 | 7 | 7 | 7 | 7 | 7 | 7 | 7 | 7 | 7 | 7 | 7 | 7 |
| c | 7 | 7 | 7 | 7 | 7 | 7 | 7 | 7 | 7 | 7 | 7 | 7 | 7 | 7 | 7 | 7 | 7 | 7 | 7 | 7 | 7 | 7 | 7 | 7 |
| b | 7 | 7 | 7 | 7 | 7 | 7 | 7 | 7 | 7 | 7 | 7 | 7 | 7 | 7 | 7 | 7 | 7 | 7 | 7 | 7 | 7 | 7 | 7 | 7 |
| a | 7 | 7 | 7 | 7 | 7 | 7 | 7 | 7 | 7 | 7 | 7 | 7 | 7 | 7 | 7 | 7 | 7 | 7 | 7 | 7 | 7 | 7 | 7 | 7 |
| z | 3 | 3 | 3 | 3 | 3 | 3 | 3 | 3 | 3 | 3 | 3 | 3 | 3 | 3 | 3 | 3 | 3 | 3 | 3 | 3 | 3 | 3 | 3 | 3 |
| | 0 | 5 | 10 | 15 | 19 | | | | | | | | | | | | | | | | | | | |

HM2P71PK5111GF

Millipacs® HM

5+2 Row male signal straight press-fit-to-board connector : TYPE AB

Description

- 5 or 5+2 Row male header with 125 signal contacts.
- Integrated polarization and guiding area without loss of signal contact positions.
- Press - fit terminations.
- 3 Mating levels.
- Non - shielded and shielded versions.
- Customized loading arrangements : see page 5.
- Board lay-out : see page 80.

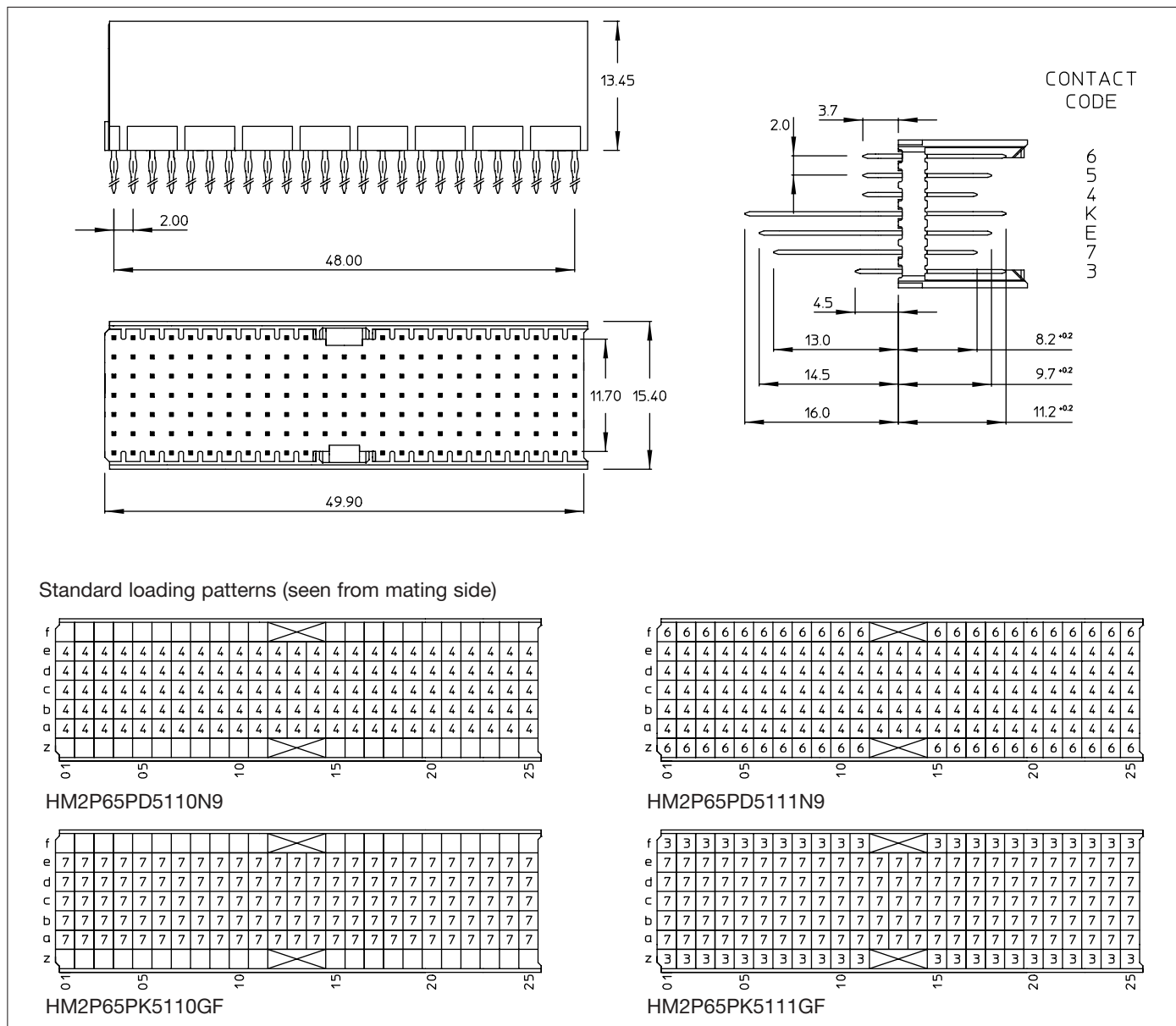
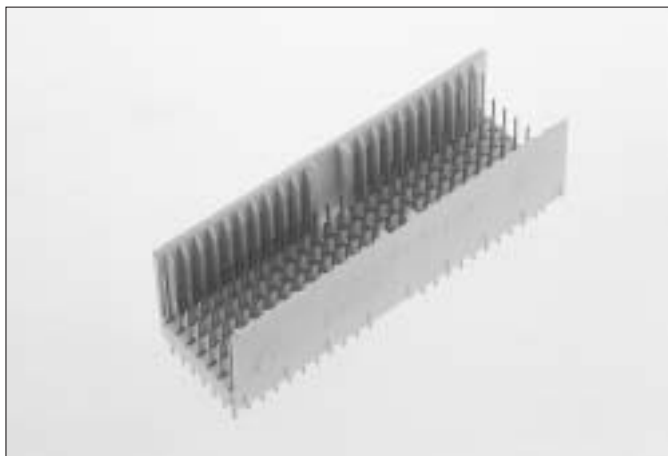

Millipacs® HM

5+2 Row male signal straight press-fit-to-board connector : TYPE AB22

Description

- 5 or 5+2 Row male header with 110 signal contacts.
- Integrated polarization and guiding area without loss of signal contact positions.
- Press - fit terminations.
- 3 Mating levels.
- Non - shielded and shielded versions.
- Customized loading arrangements : see page 5.
- Board lay-out : see page 80.
- Module also used in CompactPCI; see CompactPCI catalog.

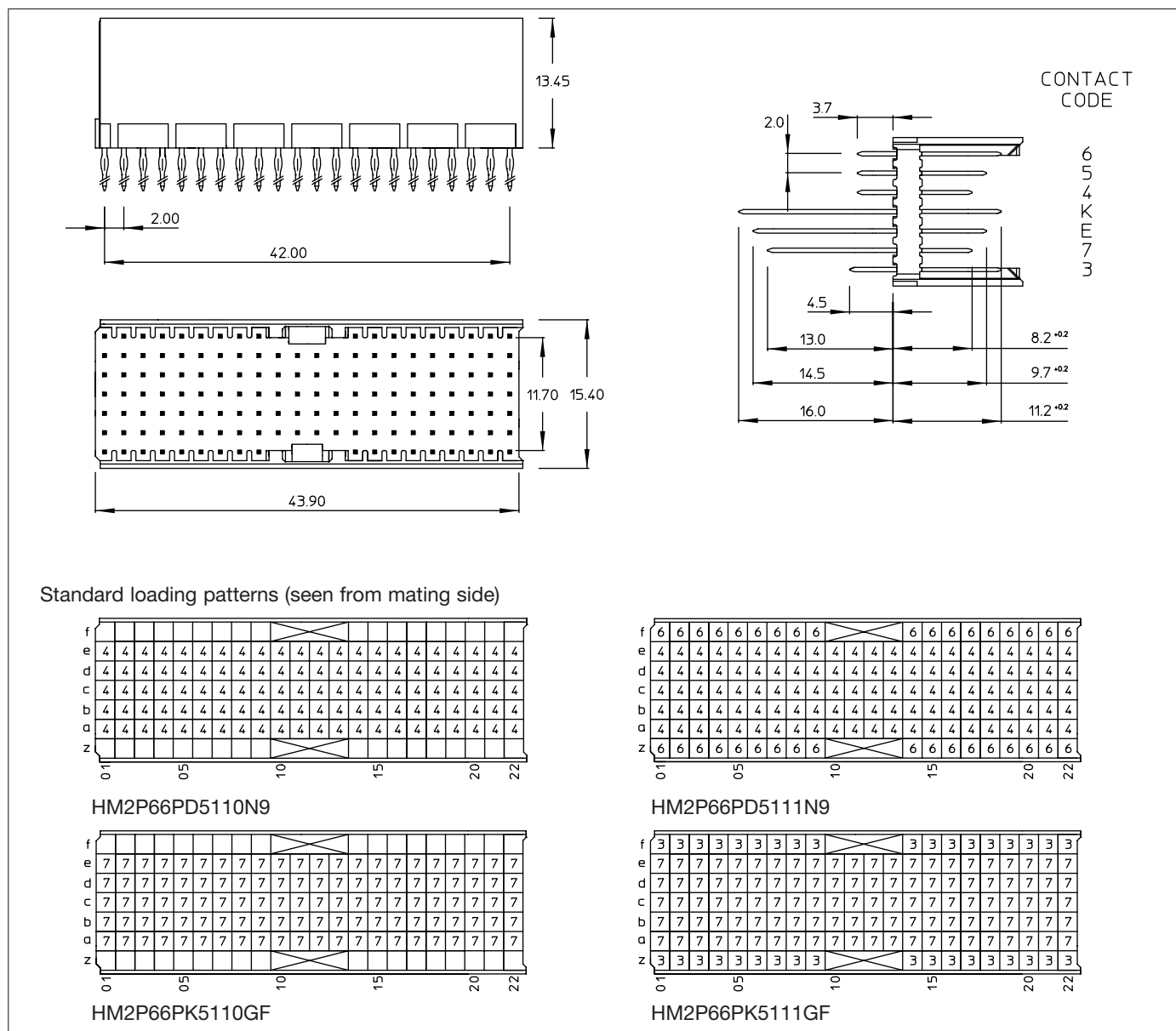
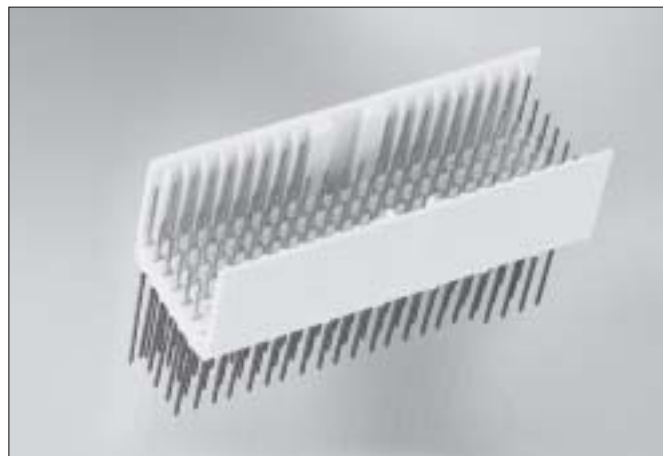

Millipacs® HM

5+2 Row male signal straight press-fit-to-board connector : TYPE AB19

Description

- 5 or 5+2 Row male header with 95 signal contacts.
- Integrated polarization and guiding area without loss of signal contact positions.
- Press - fit terminations.
- 3 Mating levels.
- Non - shielded and shielded versions.
- Customized loading arrangements : see page 5.
- Board lay-out : see page 80.
- Module also used in CompactPCI; see CompactPCI catalog.

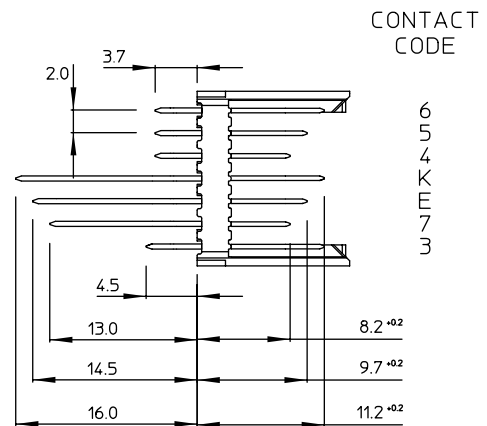
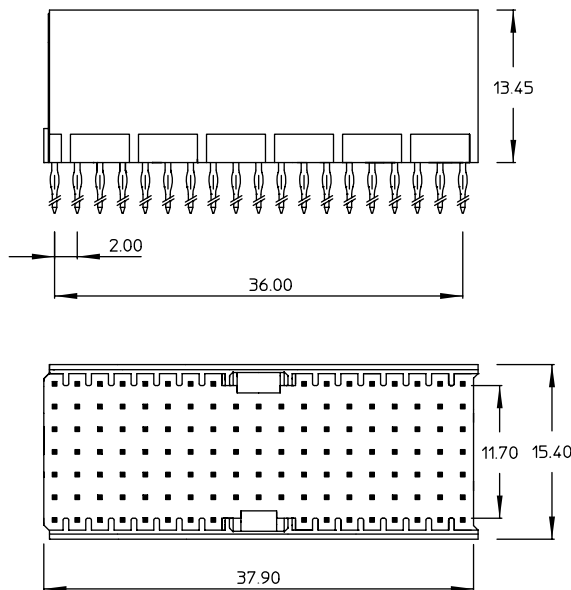
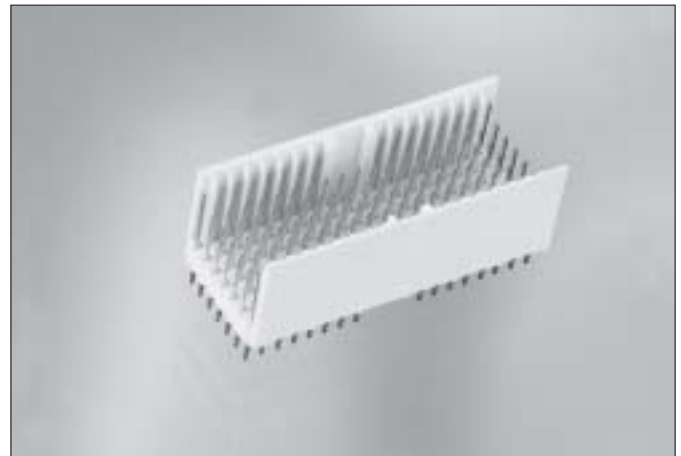

Standard loading patterns (seen from mating side)

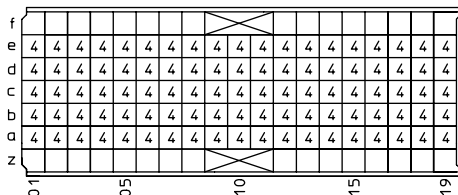

HM2P67PD5110N9

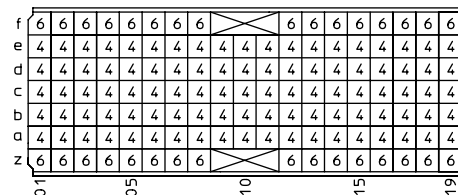

HM2P67PD5111N9

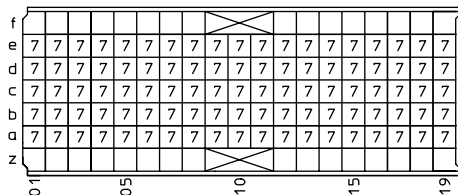

HM2P67PK5110GF

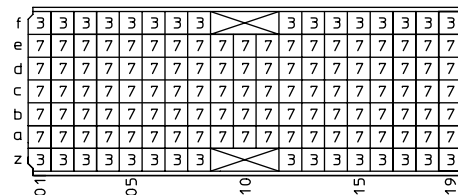

HM2P67PK5111GF

Millipacs® HM

5+2 Row male signal straight press-fit-to-board connector : TYPE C

Description

- 5 or 5+2 Row male header with 55 signal contacts.
- Integrated area for guiding & polarization.
- Press - fit terminations.
- 3 Mating levels.
- Non - shielded and shielded versions.
- Customized loading arrangements : see page 5.
- Board lay-out : see page 80.

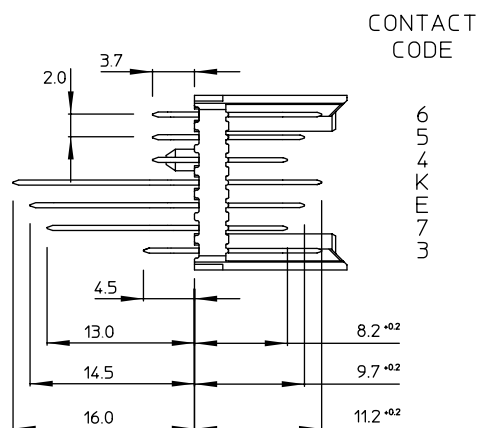
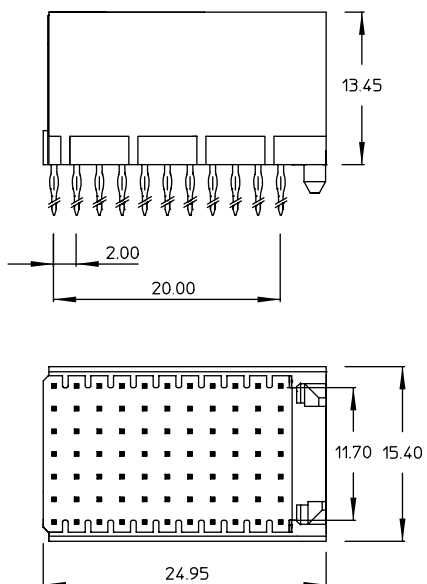
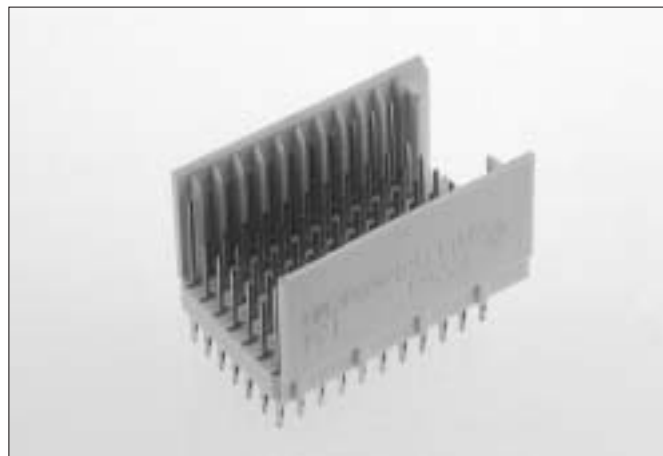

Standard loading patterns (seen from mating side)

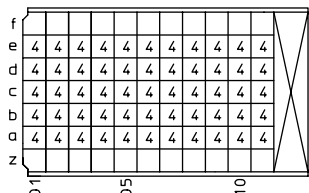

HM2P09PD5110N9

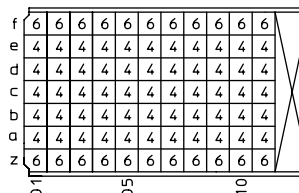

HM2P09PD5111N9

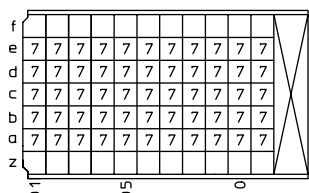

HM2P09PK5110GF

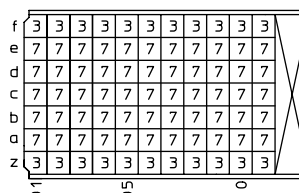

HM2P09PK5111GF

Millipacs® HM

5+2 Row male signal straight press-fit-to-board connector : TYPE CR (C Reversed, FCI terminology)

Description

- 5 or 5+2 Row male header with 55 signal contacts.
- Integrated area for guiding & polarization.
- Press - fit terminations.
- 3 Mating levels.
- Non - shielded and shielded versions.
- Customized loading arrangements : see page 5.
- Board lay-out : see page 80.

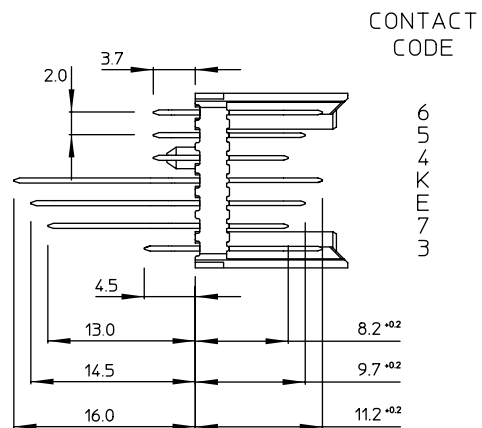
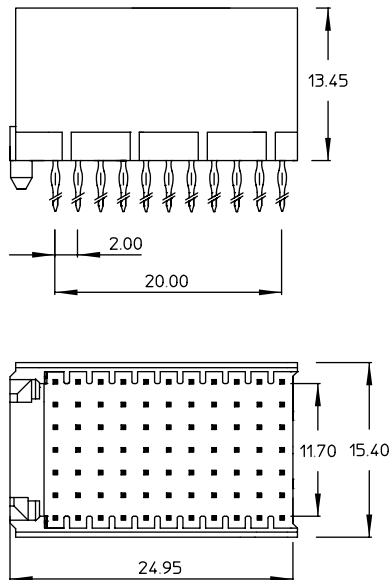
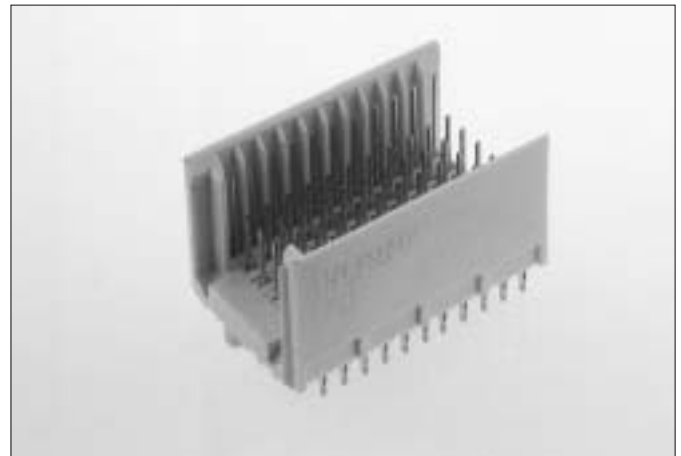

Standard loading patterns (seen from mating side)

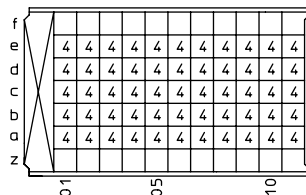

HM2P80PD5110N9

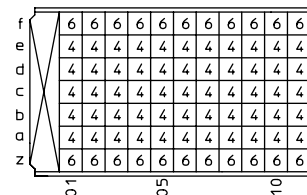

HM2P80PD5111N9

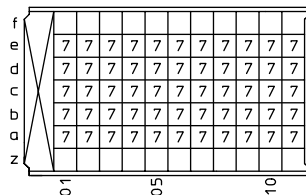

HM2P80PK5110GF

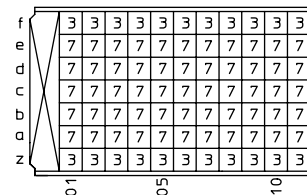

HM2P80PK5111GF

Millipacs® HM

5 Row male hybrid housing for 6 DIN contacts : TYPE L

Description

- 5 Row male housing with 6 special cavities.
- Integrated "MP" center for polarization and coding. ("MP" = multi purpose center)
- 6 x 4.8 mm diameter cavities for coax, power or FO contacts conforming DIN 41626.
- Pre-assembled modules with press-fit power contacts.
- Board lay-out : see page 80.

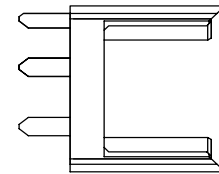
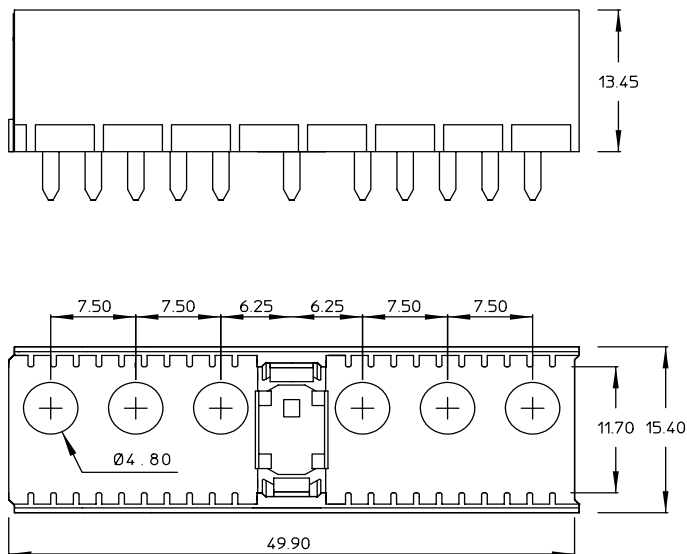
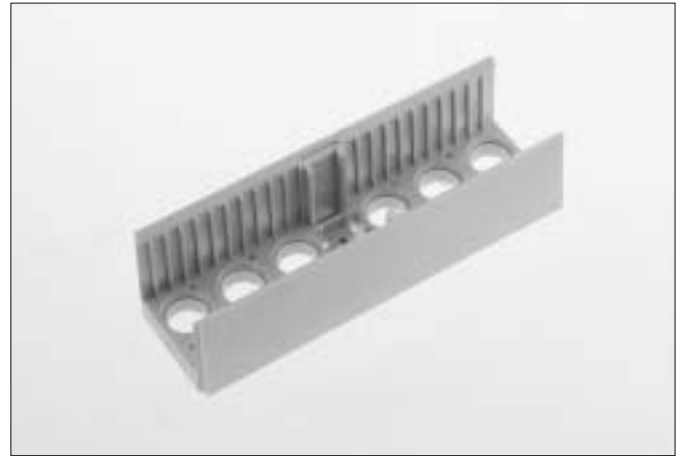

Empty housing :

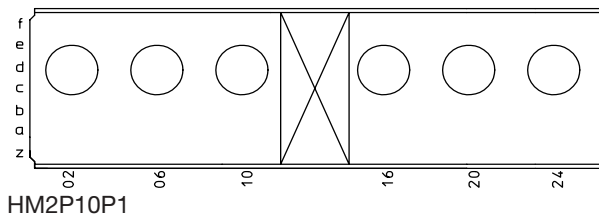

Pre-assembled module with press-fit power contacts :

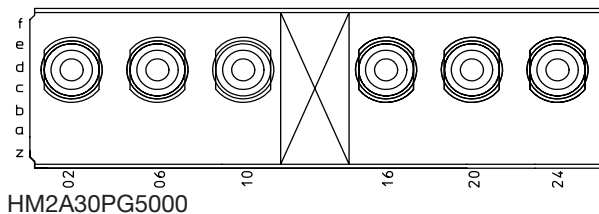

Millipacs® HM

5+2 Row mixed male signal straight press-fit-to-board connector : TYPE M

Description

- 5 or 5+2 Row male header with 55 signal contacts and 3 hybrid DIN cavities.
- Integrated “MP” center for polarization and coding. (“MP” = multi purpose center)
- Press - fit terminations for signal contacts.
- 3 Mating levels.
- Non - shielded and shielded versions.
- 3 x 4.8 mm diameter cavities for coax, power or FO contacts conforming DIN 41626.
- Pre-assembled modules with press-fit power contacts.
- Customized loading arrangements : see page 5.
- Board lay-out : see page 80.

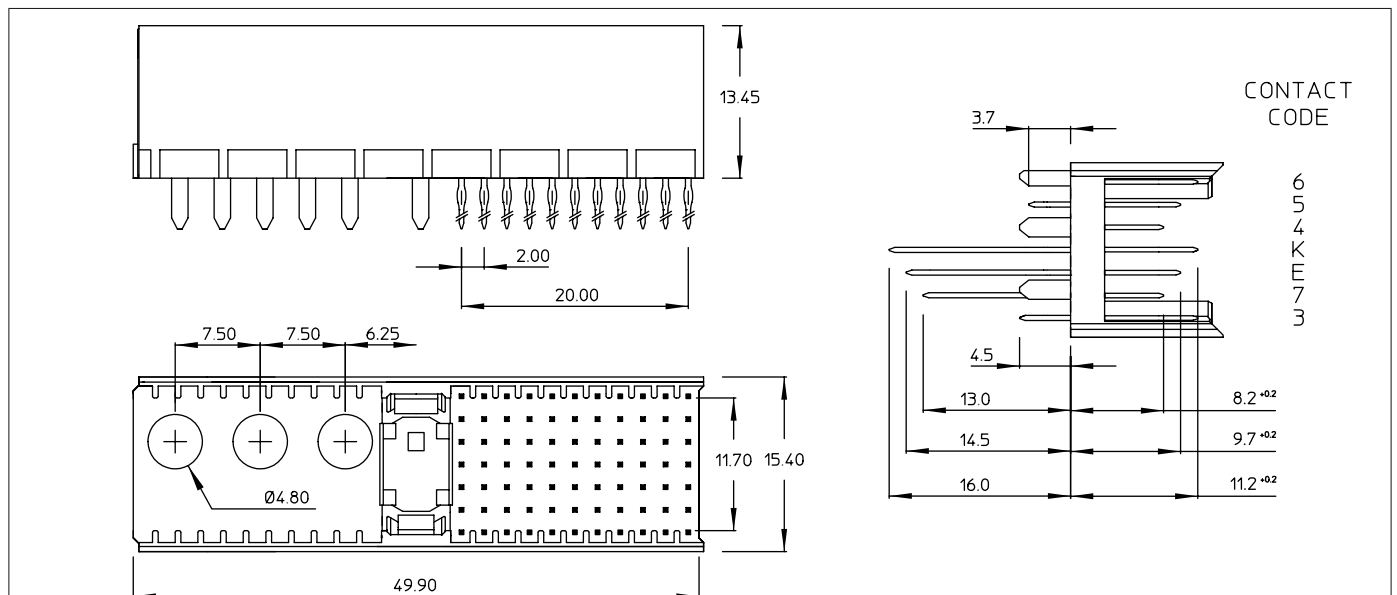

Standard loading patterns (seen from mating side)

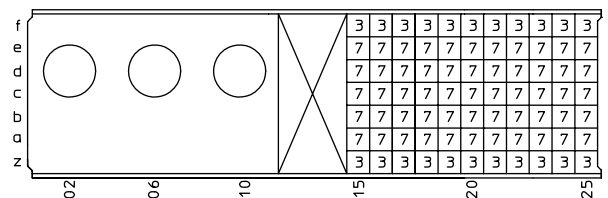
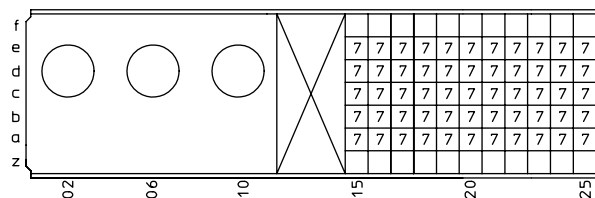
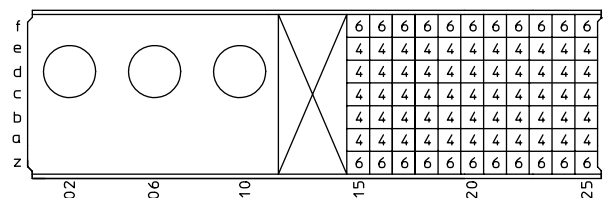
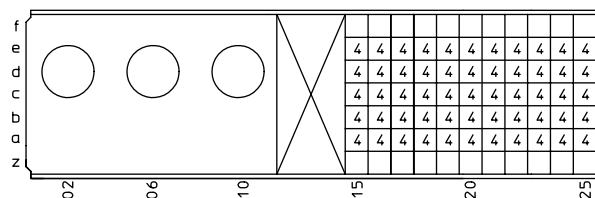

Millipacs® HM

5 Row male hybrid housing for 3 DIN contacts : TYPE N

Description

- 5 Row male housing with 3 special cavities.
- Integrated area for guiding & polarization.
- 3 x 4.8 mm diameter cavities for coax, power or FO contacts conforming DIN 41626.
- Pre-assembled modules with press-fit power contacts.
- Board lay-out : see page 80.

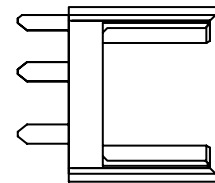
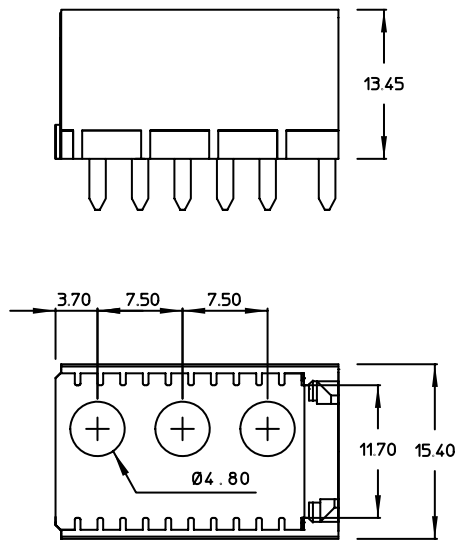
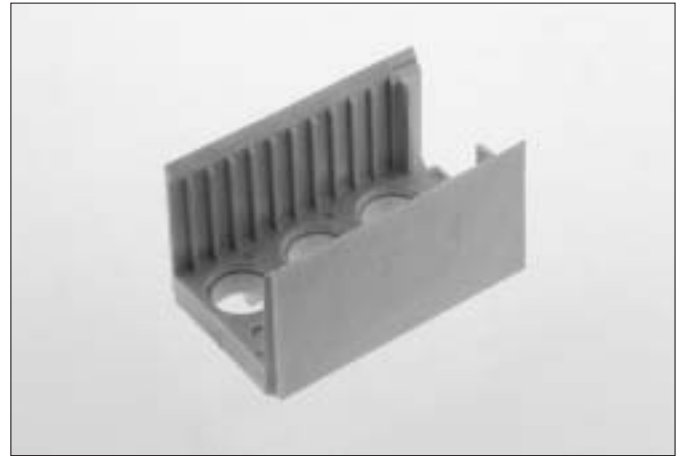

Empty housing :

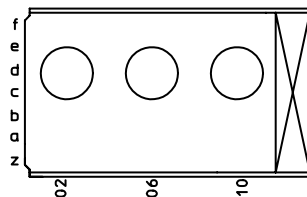

HM2P12P1

Pre-assembled module with press-fit power contacts :

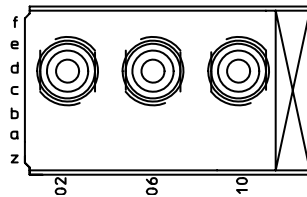

HM2A32PG5000

Millipacs® HM

8+2 Row male signal straight press-fit-to-board connector : TYPE D

Description

- 8 or 8+2 Row male header with 176 signal contacts.
- Integrated “MP” center for polarization, guiding and coding. (“MP” = multi purpose center)
- Additional guiding area, contact pin optional.
- Press - fit terminations.
- 3 Mating levels.
- Non - shielded and shielded versions.
- Customized loading arrangements : see page 5.
- Board lay-out : see page 80.

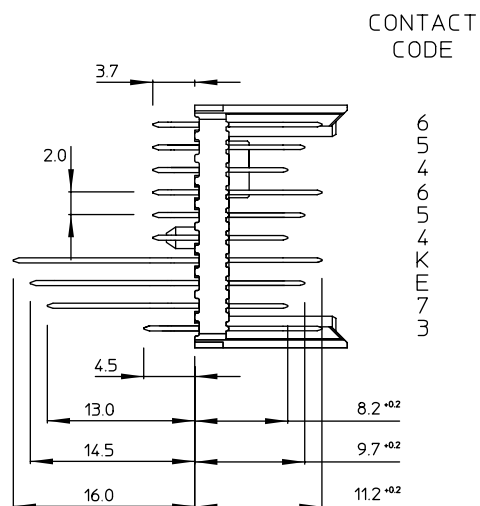
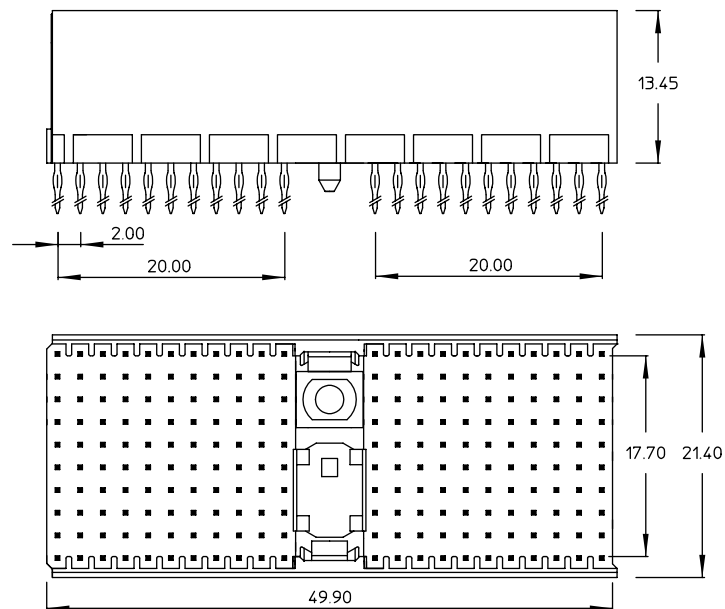
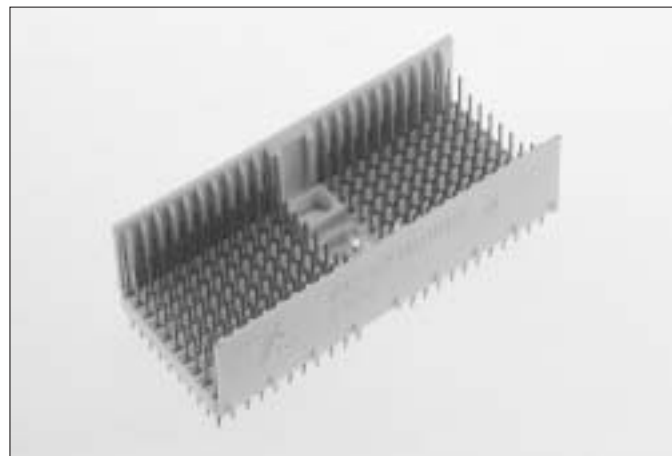

Standard loading patterns (seen from mating side)

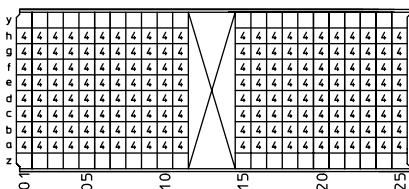

HM2P87PD8110N9

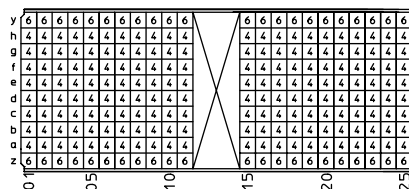

HM2P87PD8111N9

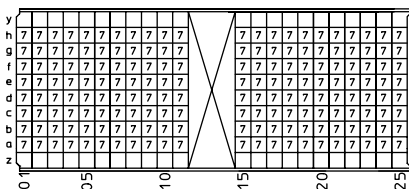

HM2P87PK8110GF

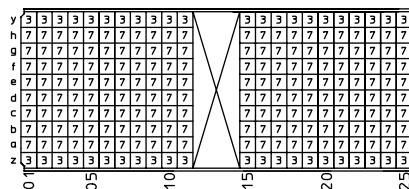

HM2P87PK8111GF

Millipacs[®] HM

8+2 Row male signal straight press-fit-to-board connector : TYPE E

Description

- 8 or 8+2 Row male header with 200 signal contacts.
- Press - fit terminations.
- 3 Mating levels.
- Non - shielded and shielded versions.
- Customized loading arrangements : see page 5.
- Board lay-out : see page 80.

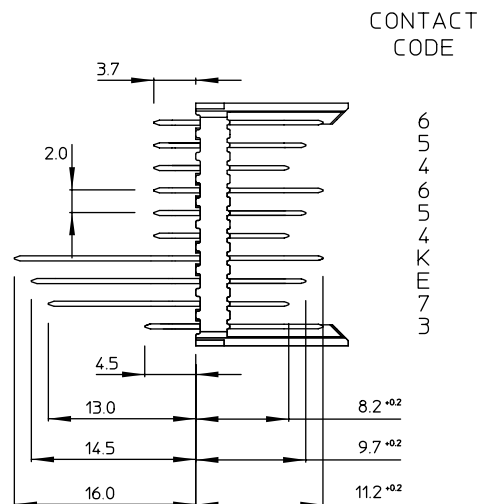
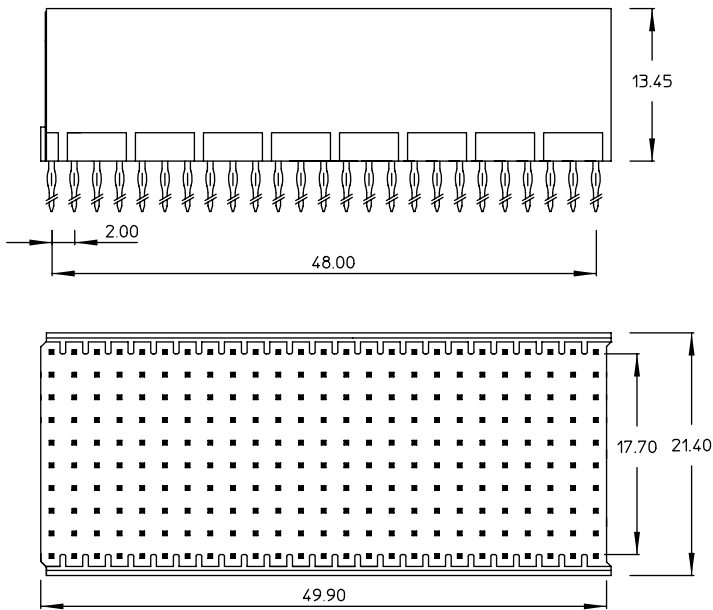
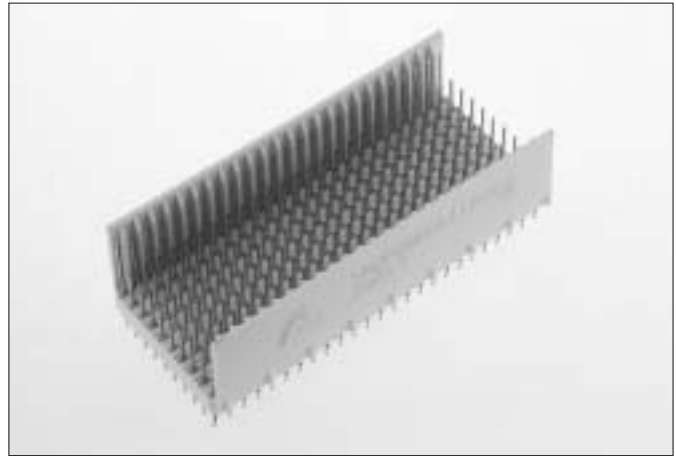

Standard loading patterns (seen from mating side)

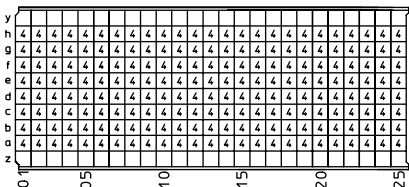

HM2P88PD8110N9

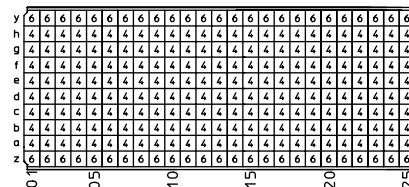

HM2P88PD8111N9

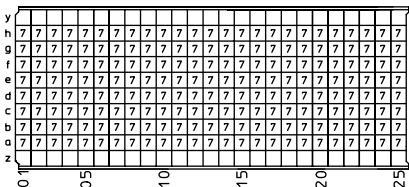

HM2P88PK8110GF

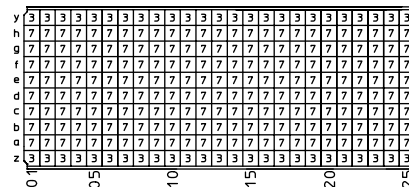

HM2P88PK8111GF

Millipacs® HM

8+2 Row male signal straight press-fit-to-board connector : TYPE DE

Description

- 8 or 8+2 Row male header with 200 signal contacts.
- Integrated polarization and guiding area without loss of signal contact position
- Press - fit terminations.
- 3 Mating levels.
- Non - shielded and shielded versions.
- Customized loading arrangements : see page 5.
- Board lay-out : see page 80.

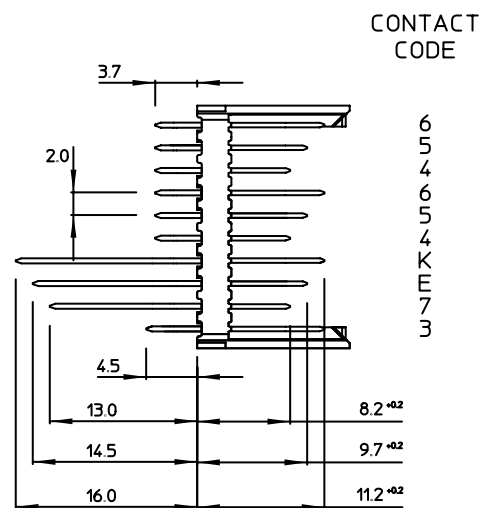
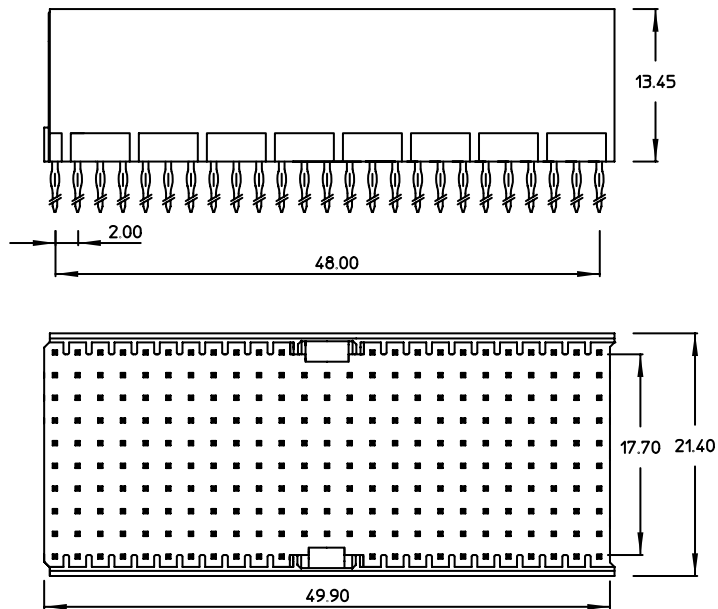
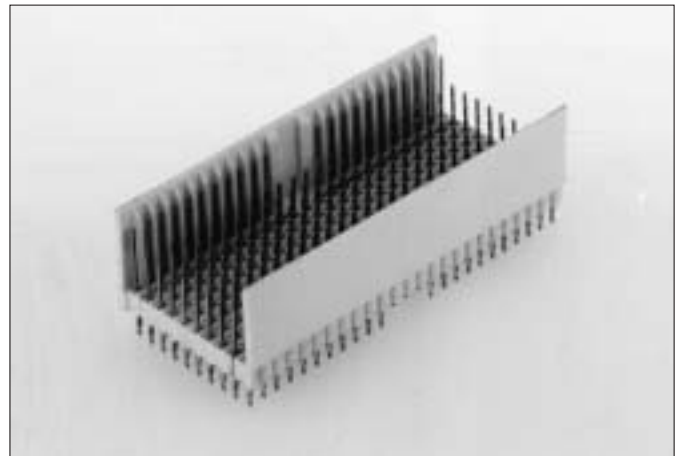

Standard loading pattern (seen from mating side)

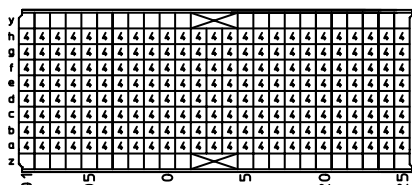

HM2P95PD8110N9

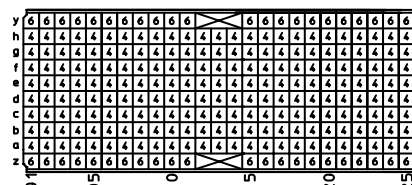

HM2P95PD8111N9

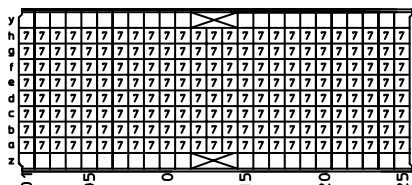

HM2P95PK8110GF

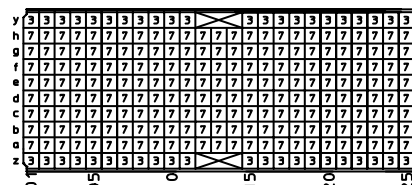

HM2P95PK8111GF

Millipacs® HM

8+2 Row male signal straight press-fit-to-board connector : TYPE F

Description

- 8 or 8+2 Row male header with 88 signal contacts.
- Integrated area for guiding & polarization.
- Press - fit terminations.
- 3 Mating levels.
- Non - shielded and shielded versions.
- Customized loading arrangements : see page 5.
- Board lay-out : see page 80.

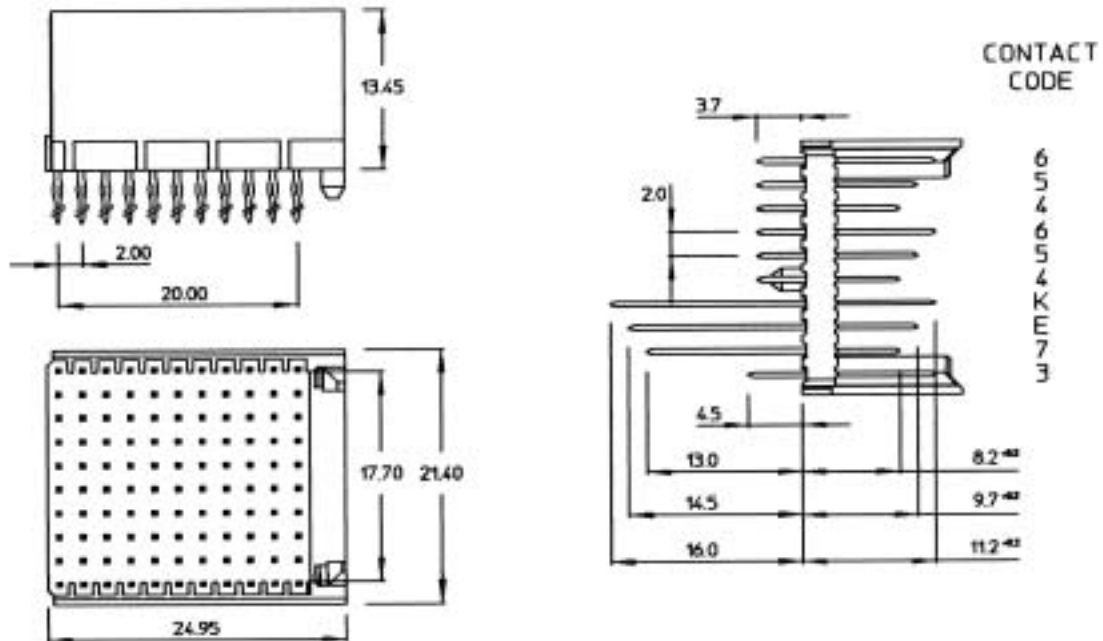
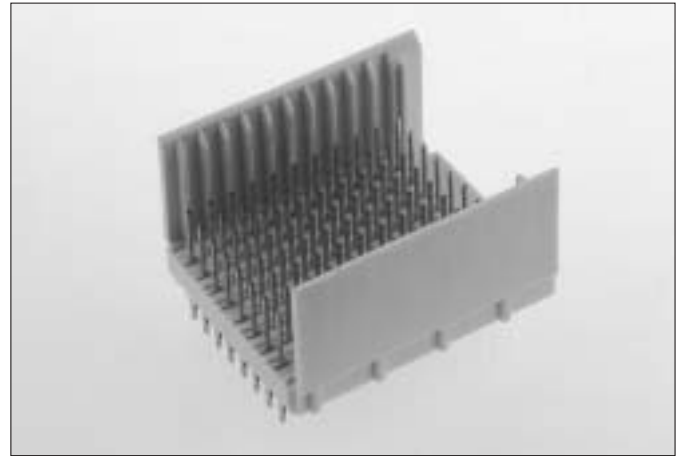

Standard loading patterns (seen from mating side)

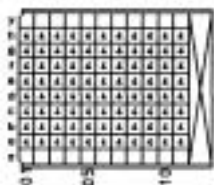

HM2P89PD8110N9

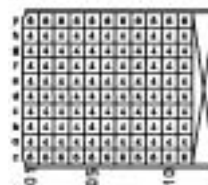

HM2P89PD8111N9

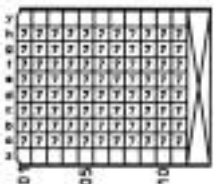

HM2P89PK8110GF

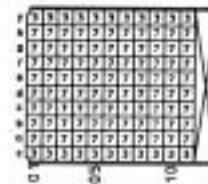

HM2P89PK8111GF

Millipacs® HM

8+2 Row male signal straight press-fit-to-board connector : TYPE FR (F Reversed, FCI terminology)

Description

- 8 or 8+2 Row male header with 88 signal contacts.
- Integrated area for guiding & polarization.
- Press - fit terminations.
- 3 Mating levels.
- Non - shielded and shielded versions.
- Customized loading arrangements : see page 5.
- Board lay-out : see page 80.

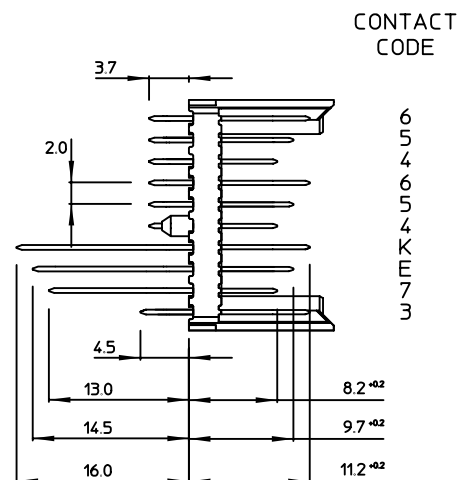
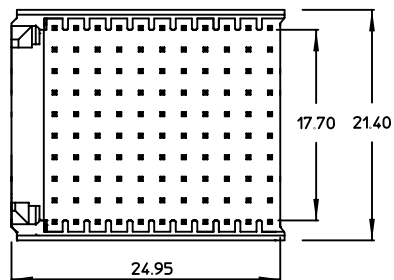
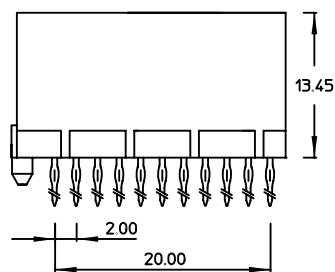

Standard loading patterns (seen from mating side)

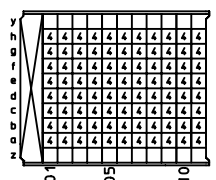

HM2P82PD8110N9

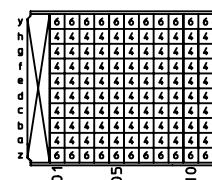

HM2P82PD8111N9

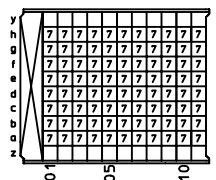

HM2P82PK8110GF

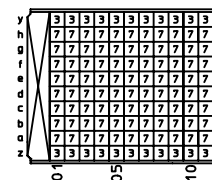

HM2P82PK8111GF

Millipacs® HM

5+2 Row female signal right angle press-fit-to-board connector : TYPE A

Description

- 5 or 5+2 Row female right angle connector with 110 signal contacts.
- Integrated "MP" center for polarization and coding.
("MP" = multi purpose center)
- Press - fit terminations.
- Non - shielded and shielded versions.
- Customized loading arrangements on request.
- Additional lower shield : see page 47.
- Board lay-out : see page 80.
- Module also used in CompactPCI; see CompactPCI catalog.

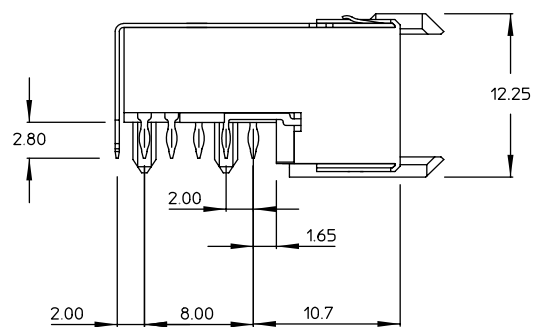
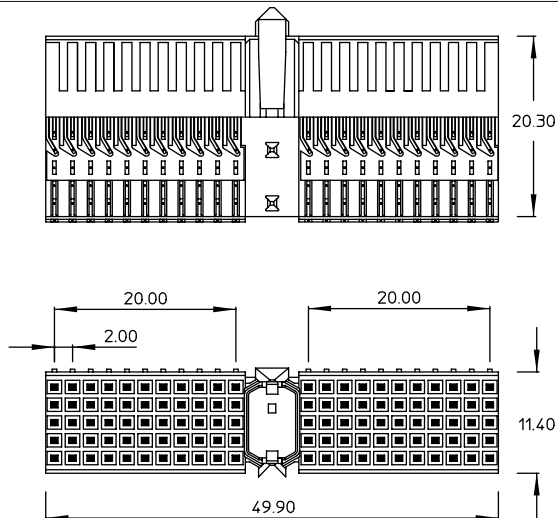
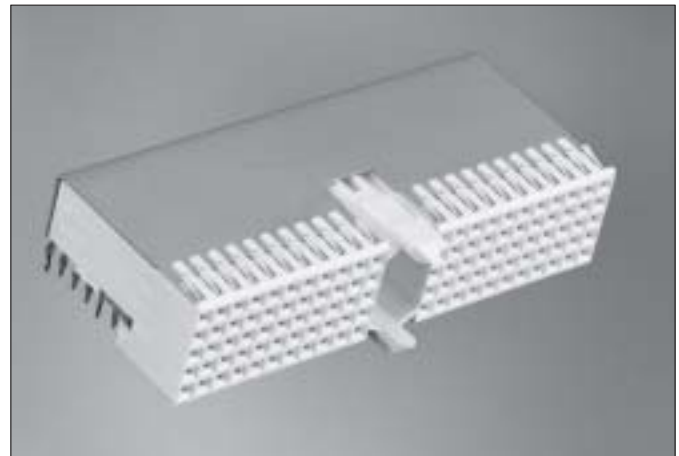

Standard product offer with location pegs :

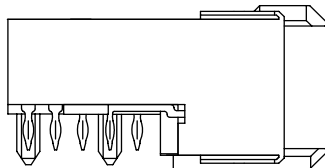

HM2R01PA5100N9
(non shielded)

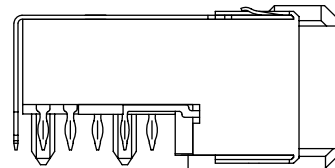

HM2R01PA5108N9
(top shielded only, 4 mm pitch)

Standard product offer without location pegs :

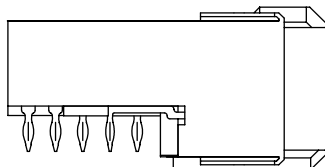

HM2R10PA5100N9
(non shielded)

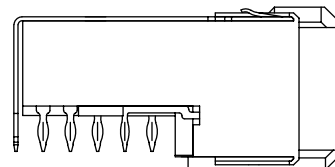

HM2R10PA5108N9
(top shielded only, 4 mm pitch)

Millipacs® HM

5+2 Row female signal right angle press-fit-to-board connector : TYPE B

Description

- 5 or 5+2 Row female right angle connector with 125 signal contacts.
- Press - fit terminations.
- Non - shielded and shielded versions.
- Customized loading arrangements on request.
- Additional lower shield : see page 47.
- Board lay-out : see page 80.

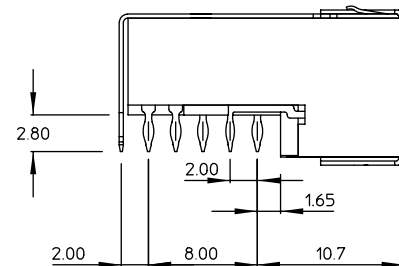
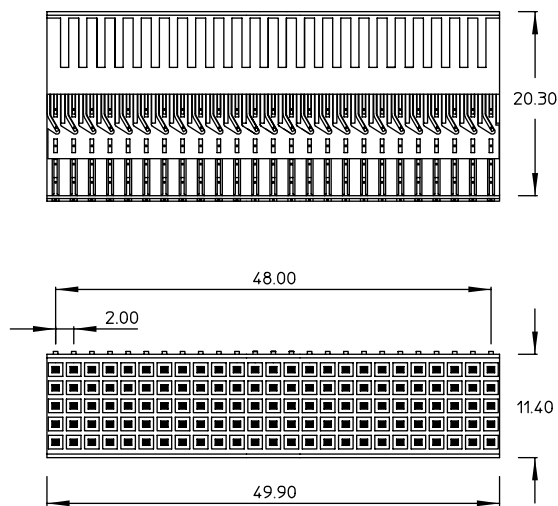
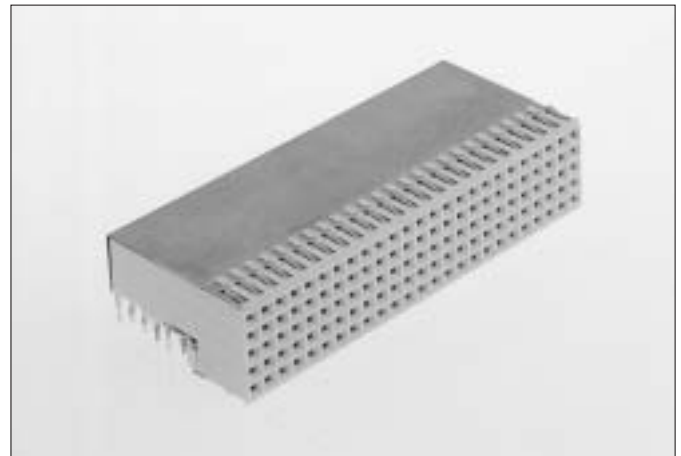

Standard product offer :

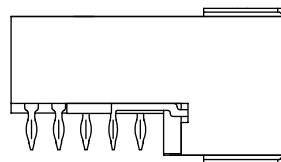

HM2R02PA5100N9
(non shielded)

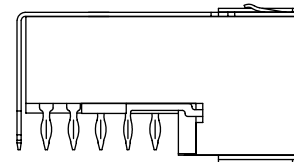

HM2R02PA5108N9
(top shielded only, 4 mm pitch)

Millipacs® HM

5+2 Row female signal right angle press-fit-to-board connector : TYPE B22

Description

- 5 or 5+2 Row female right angle connector with 110 signal contacts.
- Press - fit terminations.
- Non - shielded and shielded versions.
- Customized loading arrangements on request.
- Additional lower shield : see page 47.
- Board lay-out : see page 80.
- Module also used in CompactPCI; see CompactPCI catalog.

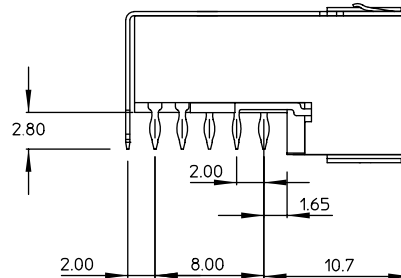
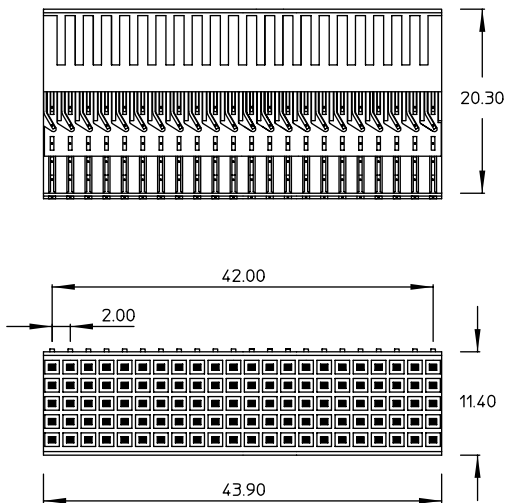
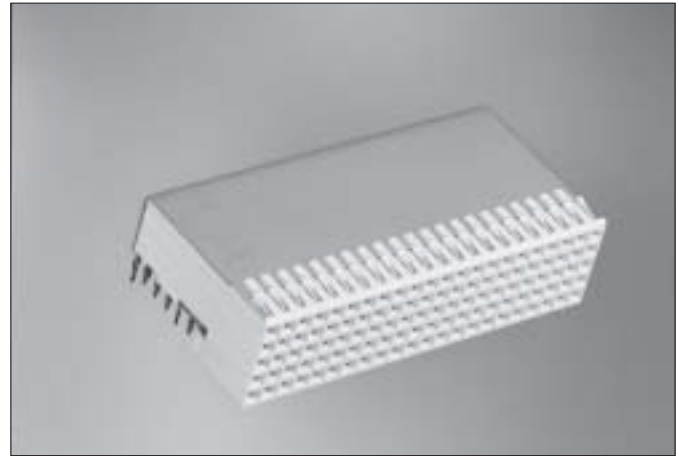

Standard product offer :

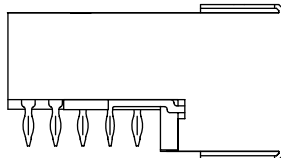

HM2R70PA5100N9
(non shielded)

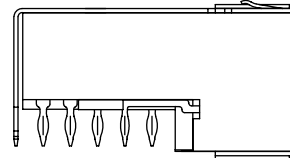

HM2R70PA5108N9
(top shielded only, 4 mm pitch)

Millipacs® HM

5+2 Row female signal right angle press-fit-to-board connector : TYPE B19

Description

- 5 or 5+2 Row female right angle connector with 95 signal contacts.
- Press - fit terminations.
- Non - shielded and shielded versions.
- Customized loading arrangements on request.
- Additional lower shield : see page 47.
- Board lay-out : see page 80.
- Module also used in CompactPCI; see CompactPCI catalog.

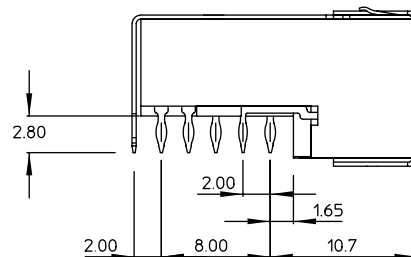
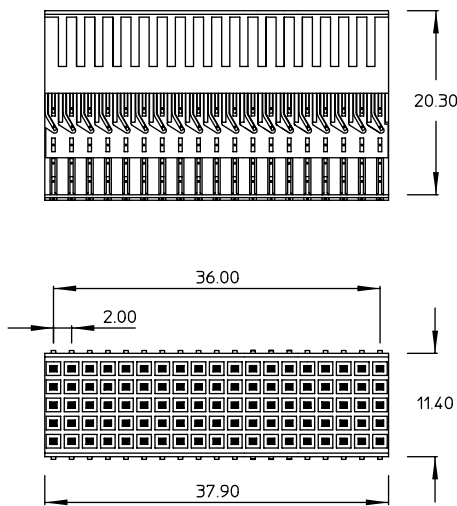
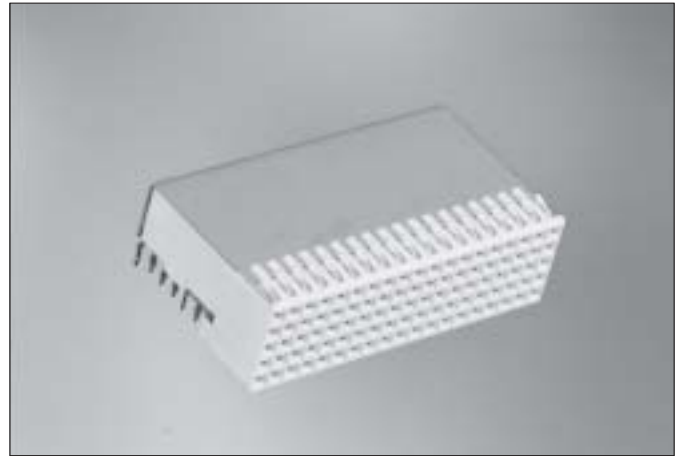

Standard product offer :

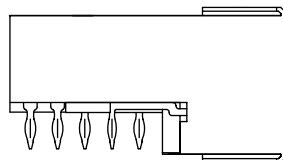

HM2R71PA5100N9
(non shielded)

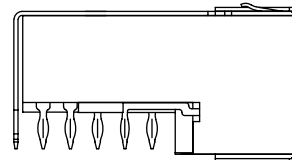

HM2R71PA5108N9
(top shielded only, 4 mm pitch)

Millipacs® HM

5+2 Row female signal right angle press-fit-to-board connector : TYPE AB

Description

- 5 or 5+2 Row female right angle connector with 125 signal contacts.
- Integrated polarization and guiding center without loss of signal contact positions.
- Press - fit terminations.
- Non - shielded and shielded versions.
- Customized loading arrangements on request.
- Additional lower shield : see page 47.
- Board lay-out : see page 80.

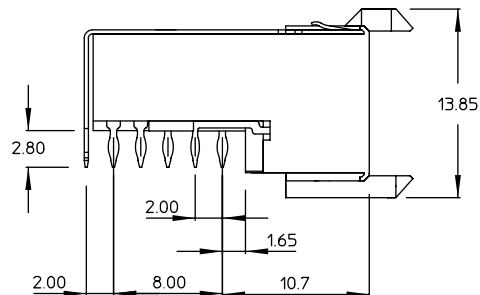
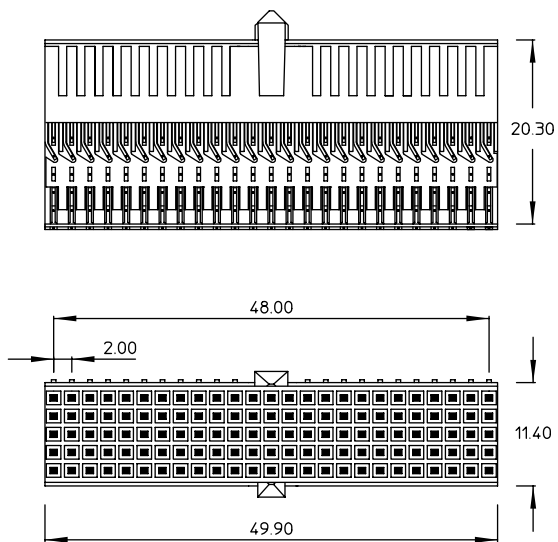
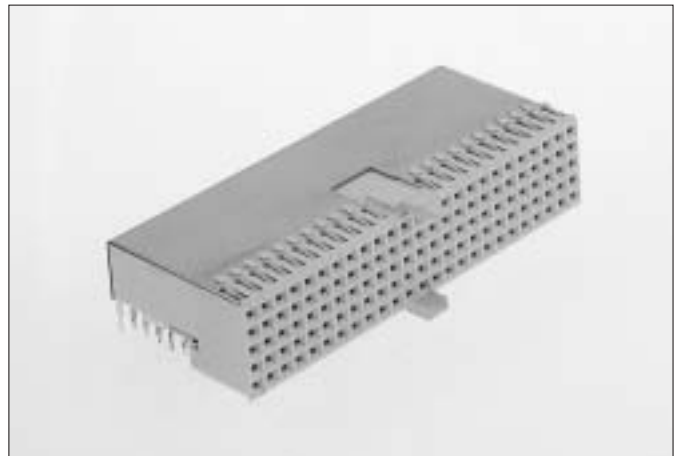

Standard product offer :

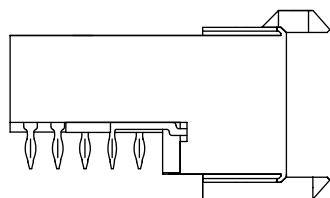

HM2R65PA5100N9
(non shielded)

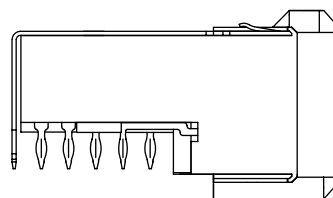

HM2R65PA5108N9
(top shielded only, 4 mm pitch)

Millipacs® HM

5+2 Row female signal right angle press-fit-to-board connector : TYPE AB22

Description

- 5 or 5+2 Row female right angle connector with 110 signal contacts.
- Integrated polarization and guiding center without loss of signal contact positions.
- Press - fit terminations.
- Non - shielded and shielded versions.
- Customized loading arrangements on request.
- Additional lower shield : see page 47.
- Board lay-out : see page 80.
- Module also used in CompactPCI; see CompactPCI catalog.

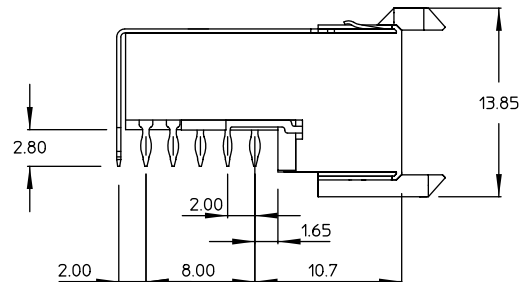
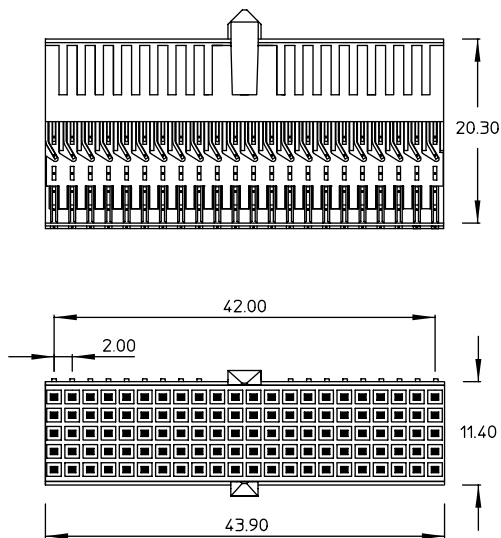
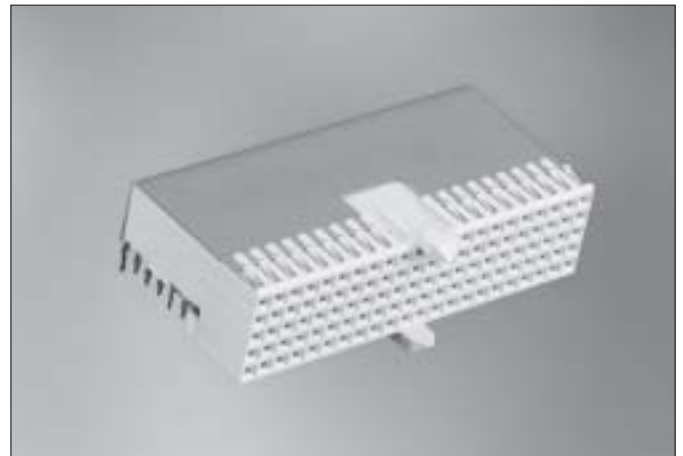

Standard product offer :

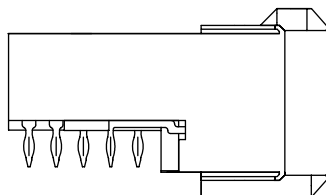

HM2R66PA5100N9
(non shielded)

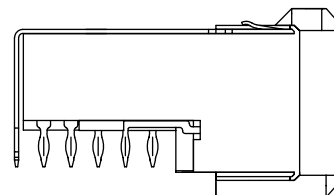

HM2R66PA5108N9
(top shielded only, 4 mm pitch)

Millipacs® HM

5+2 Row female signal right angle press-fit-to-board connector : TYPE AB19

Description

- 5 or 5+2 Row female right angle connector with 95 signal contacts.
- Integrated polarization and guiding center without loss of signal contact positions.
- Press - fit terminations.
- Non - shielded and shielded versions.
- Customized loading arrangements on request.
- Additional lower shield : see page 47.
- Board lay-out : see page 80.
- Module also used in CompactPCI; see CompactPCI catalog.

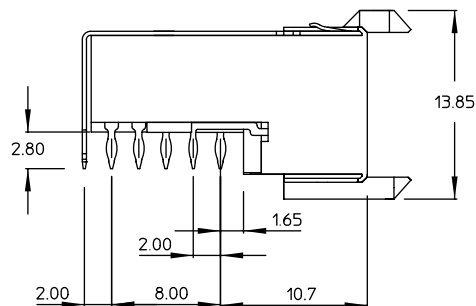
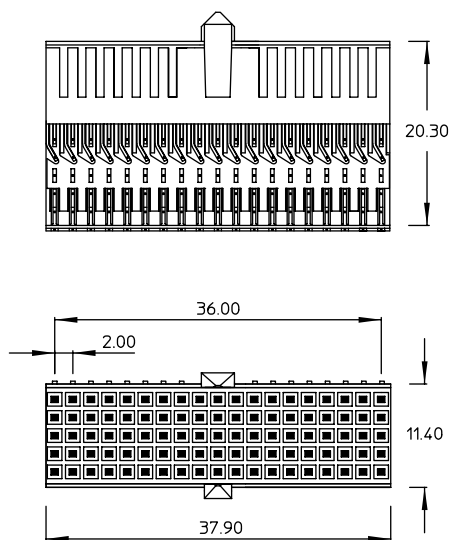

Standard product offer :

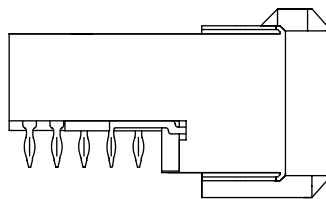

HM2R67PA5100N9
(non shielded)

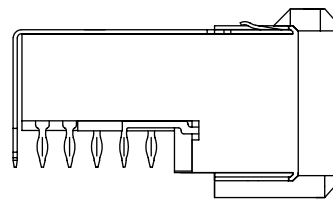

HM2R67PA5108N9
(top shielded only, 4 mm pitch)

Millipacs® HM

5+2 Row female signal right angle press-fit-to-board connector : TYPE C

Description

- 5 or 5+2 Row female right angle connector with 55 signal contacts.
- Integrated pegs for guiding & polarization.
- Press - fit terminations.
- Non - shielded and shielded versions.
- Customized loading arrangements on request.
- Additional lower shield : see page 47.
- Board lay-out : see page 80.

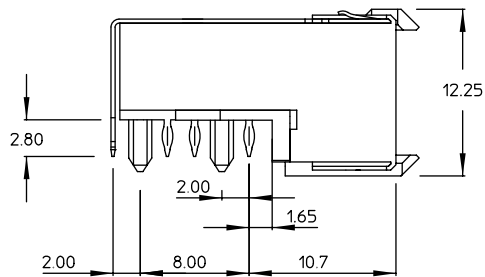
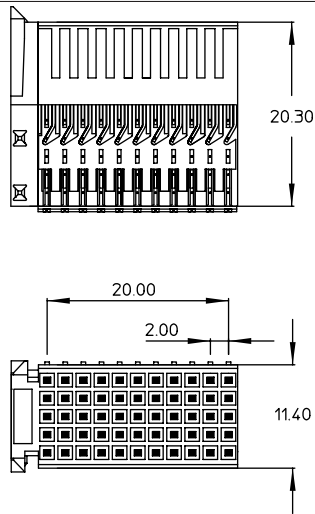
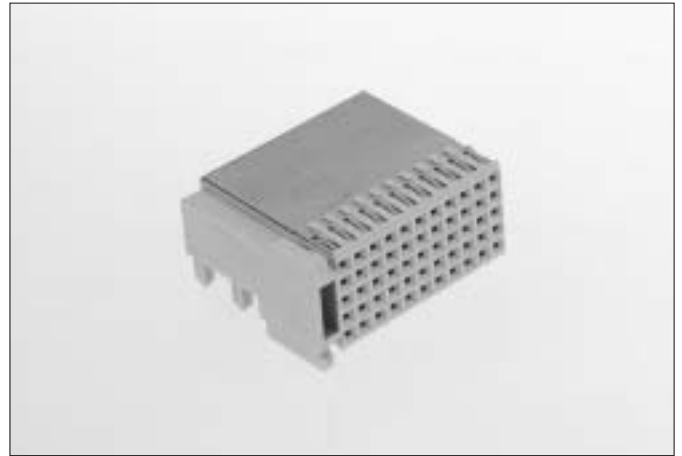

Standard product offer : with location pegs

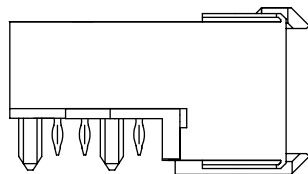

HM2R03PA5100N9
(non shielded)

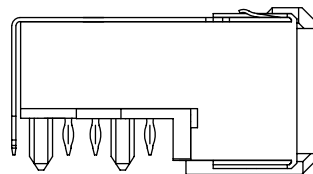

HM2R03PA5108N9
(top shielded only, 4 mm pitch)

Standard product offer : without location pegs

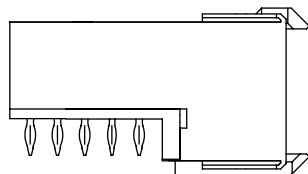

HM2R30PA5100N9
(non shielded)

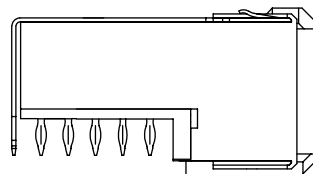

HM2R30PA5108N9
(top shielded only, 4 mm pitch)

Millipacs® HM

5+2 Row female signal right angle press-fit-to-board connector : TYPE CR (C Reversed, FCI terminology)

Description

- 5 or 5+2 Row female right angle connector with 55 signal contacts.
- Integrated pegs for guiding & polarization.
- Press - fit terminations.
- Non - shielded and shielded versions.
- Customized loading arrangements on request.
- Additional lower shield : see page 47.
- Board lay-out : see page 80.

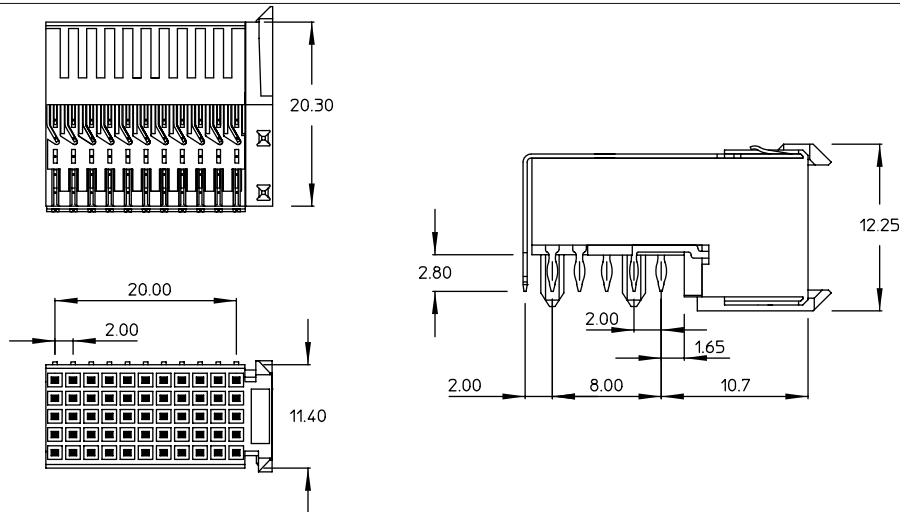

Standard product offer : with location pegs

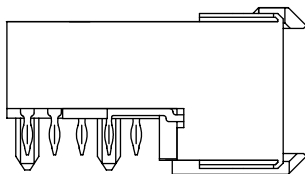

HM2R20PA5100N9
(non shielded)

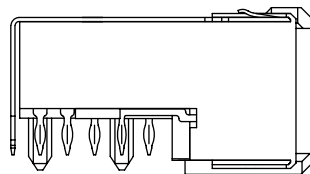

HM2R20PA5108N9
(top shielded only, 4 mm pitch)

Standard product offer : without location pegs

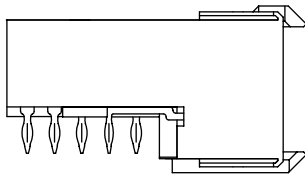

HM2R21PA5100N9
(non shielded)

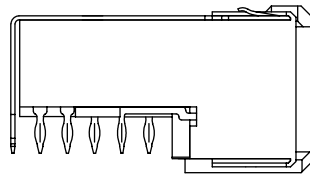

HM2R21PA5108N9
(top shielded only, 4 mm pitch)

Millipacs® HM

5 Row female hybrid right angle housing for 6 DIN contacts : TYPE L

Description

- 5 Row female hybrid right angle housing with 6 special cavities.
- Integrated "MP" center for polarization and coding. ("MP" = multi purpose center)
- 6 x 4.8 mm diameter cavities for coax, power or FO contacts conforming DIN 41626.
- Pre-assembled modules with press-fit power contacts.
- Board lay-out : see page 80.

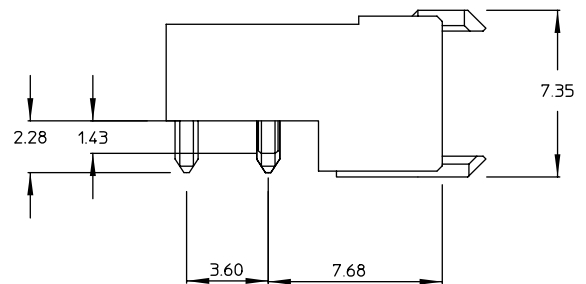
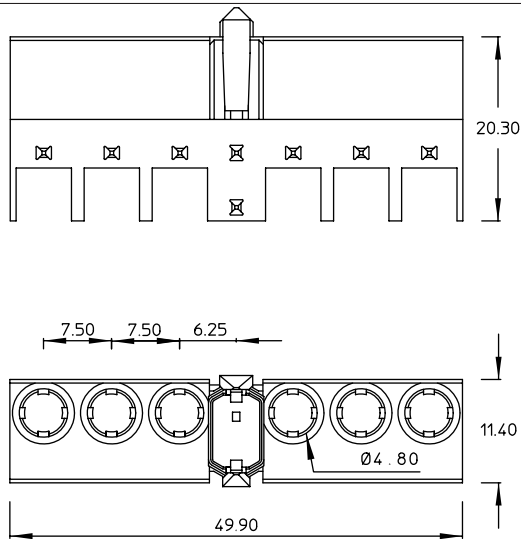
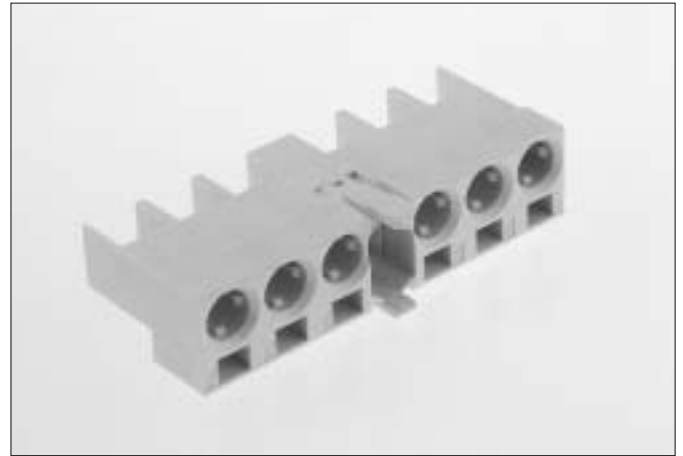

Standard product offer :

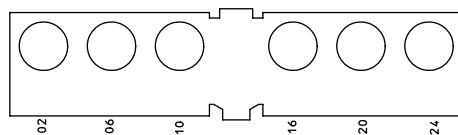

HM2R04P1

Pre-assembled module with press-fit power contacts :

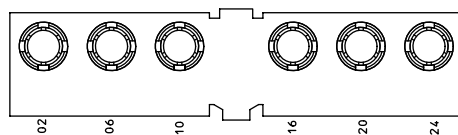

HM2E30PH5000

Millipacs® HM

5+2 Row mixed female signal right angle press-fit-to-board connector : TYPE M

Description

- 5 or 5+2 Row female right angle connector with 55 signal contacts and 3 hybrid DIN cavities.
- Integrated "MP" center for polarization and coding. ("MP" = multi purpose center)
- 3 x 4.8 mm diameter cavities for coax, power or FO contacts conforming DIN 41626.
- Press - fit terminations for signal contacts.
- Non - shielded and shielded versions.
- Pre-assembled modules with power press-fit contacts on request.
- Customized loading arrangements.
- Additional lower shield: see page 47.
- Board lay-out : see page 80.

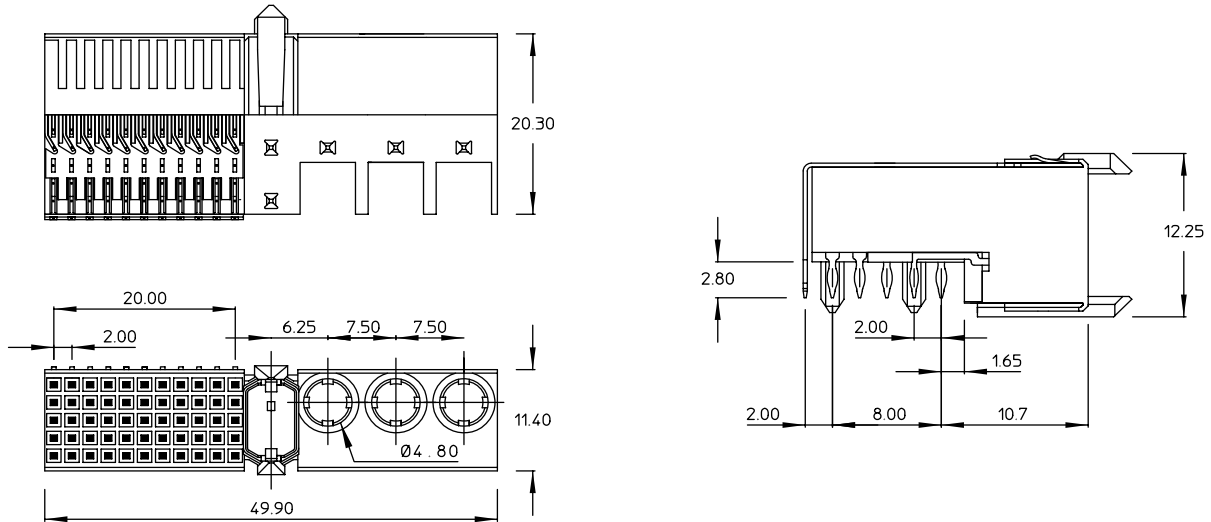
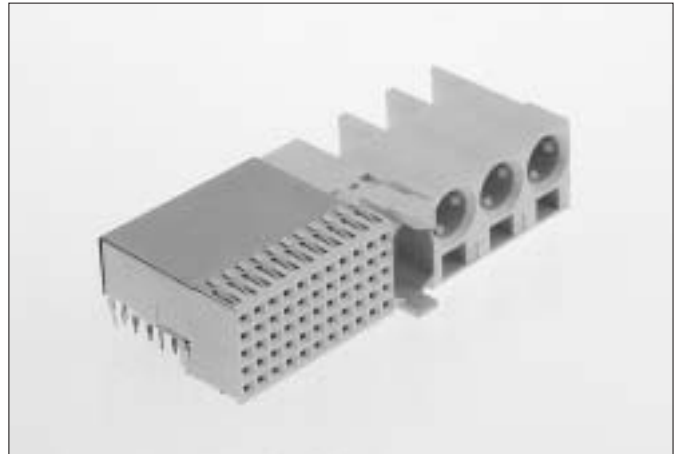

Standard product offer : with location pegs

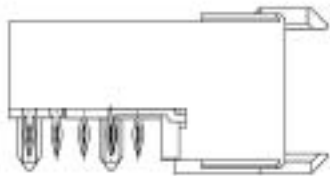

HM2R05PA5100N9
(non shielded)

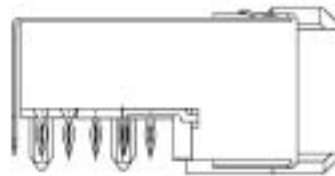

HM2R05PA5108N9
(top shielded only, 4 mm pitch)

Standard product offer : without location pegs

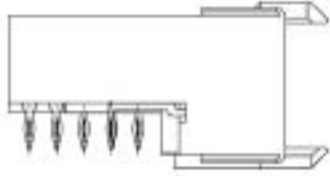

HM2R50PA5100N9
(non shielded)

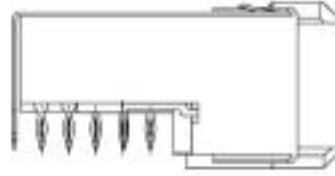

HM2R50PA5108N9
(top shielded only, 4 mm pitch)

Millipacs® HM

5 Row female hybrid right angle housing for 3 DIN contacts : TYPE N

Description

- 5 Row female hybrid right angle housing with 3 special cavities.
- Integrated pegs for guiding & polarization.
- 3 x 4.8 mm diameter cavities for coax, power or FO contacts conforming DIN 41626.
- Pre-assembled modules with press-fit power contacts.
- Board lay-out : see page 80.

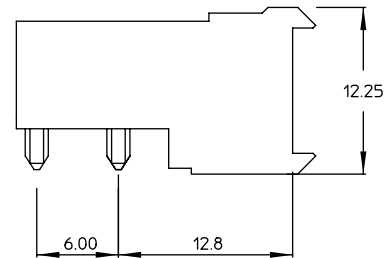
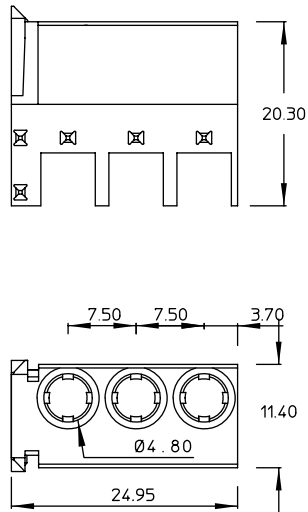

Standard product offer :

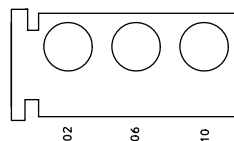

HM2R06P1

Pre-assembled module with press-fit power contacts :

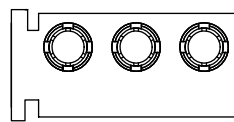

HM2E32PH5000

Millipacs® HM

8+2 Row female signal right angle press-fit-to-board connector : TYPE D

Description

- 8 or 8+2 Row female right angle connector with 176 signal contacts.
- Integrated "MP" center for polarization, guiding and coding. ("MP" = multi purpose center)
- Press - fit terminations.
- Non - shielded and shielded versions.
- Customized loading arrangements on request.
- Additional lower shield : see page 47.
- Board lay-out : see page 80.

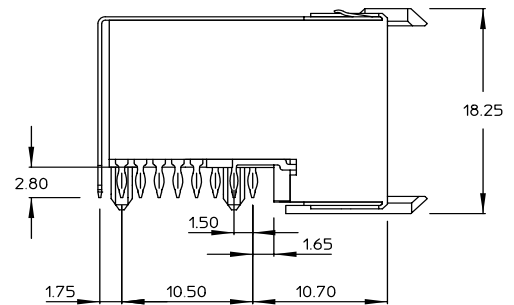
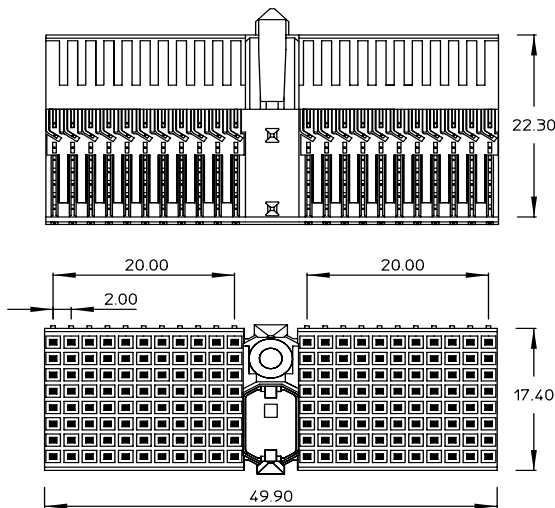
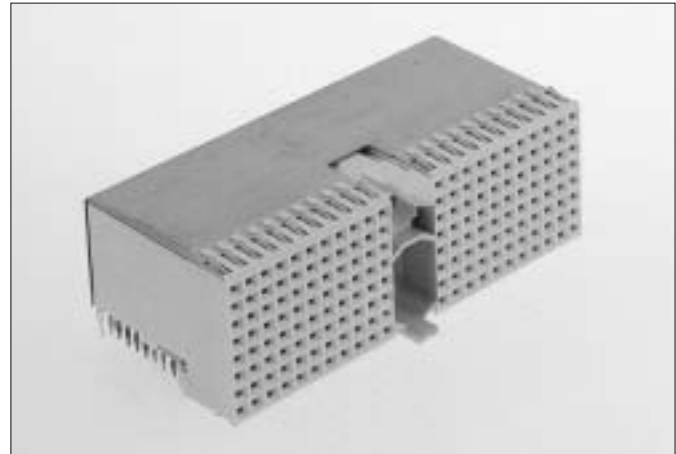

Standard product offer with location pegs :

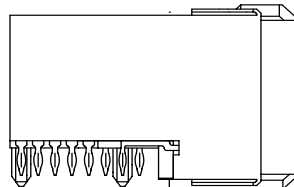

HM2R87PA8100N9
(non shielded)

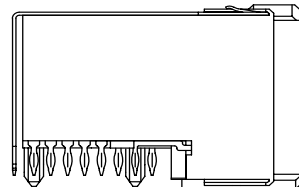

HM2R87PA8108N9
(top shielded only, 4 mm pitch)

Standard product offer without location pegs :

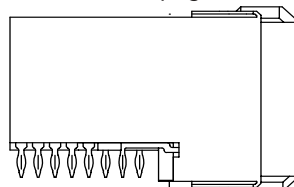

HM2R81PA8100N9
(non shielded)

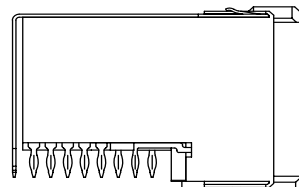

HM2R81PA8108N9
(top shielded only, 4 mm pitch)

Millipacs® HM

8+2 Row female signal right angle press-fit-to-board connector : TYPE E

Description

- 8 or 8+2 Row female right angle connector with 200 signal contacts.
- Press - fit terminations.
- Non - shielded and shielded versions.
- Customized loading arrangements on request.
- Additional lower shield : see page 47.
- Board lay-out : see page 80.

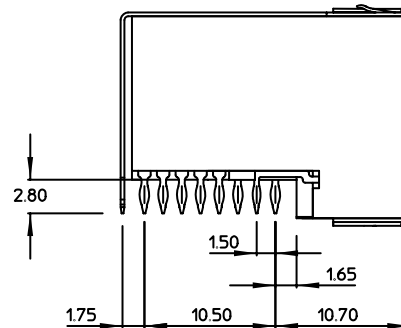
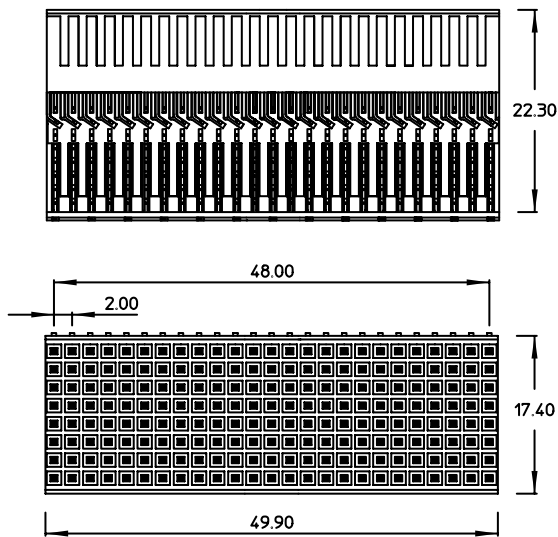
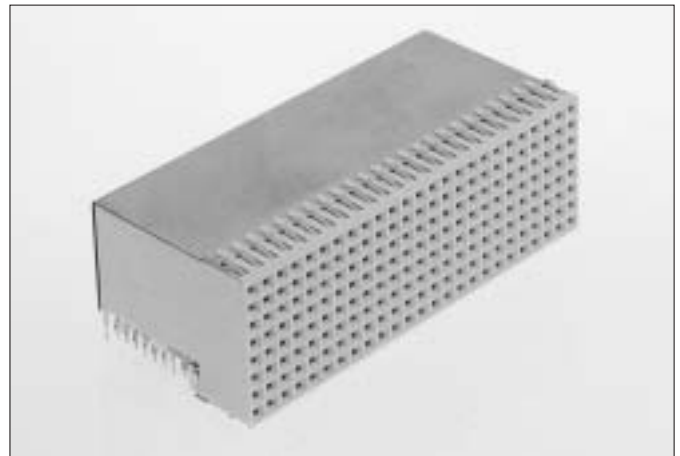

Standard product offer :

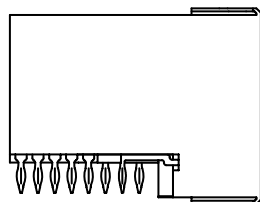

HM2R88PA8100N9
(non shielded)

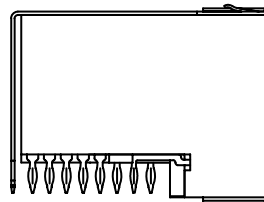

HM2R88PA8108N9
(top shielded only, 4 mm pitch)

Millipacs® HM

8+2 Row female signal right angle press-fit-to-board connector : TYPE DE

Description

- 8 or 8+2 Row female right angle connector with 200 signal contacts.
- Integrated polarization and guiding center without loss of signal contact position.
- Press - fit terminations.
- Non - shielded and shielded versions.
- Customized loading arrangements on request.
- Additional lower shield : see page 47.
- Board lay-out : see page 80.

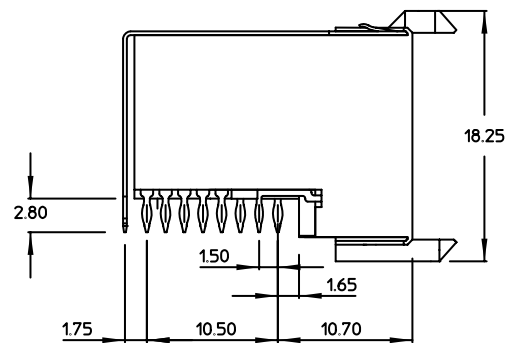
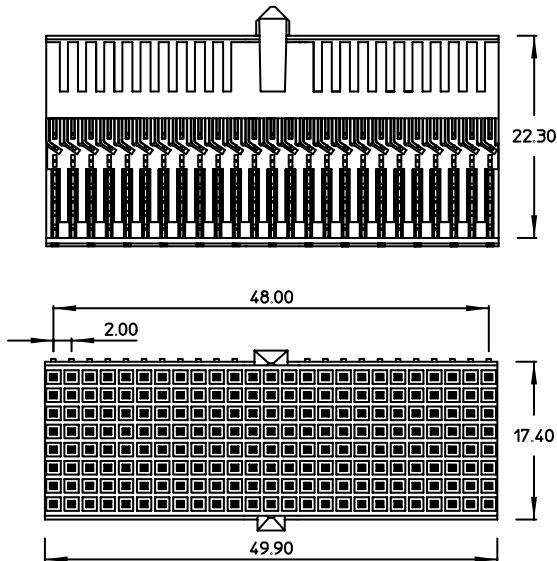
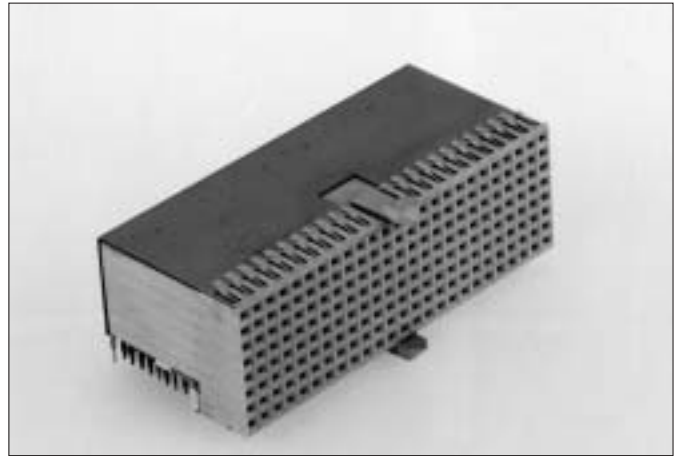

Standard product offer

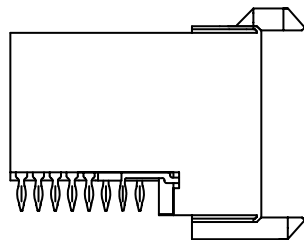

HM2R95PA8100N9
(non shielded)

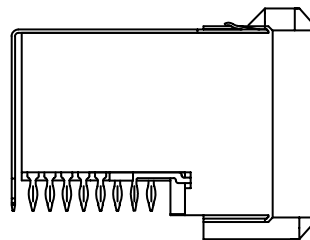

HM2R95PA8108N9
(top shielded only, 4 mm pitch)

Millipacs® HM

8+2 Row female signal right angle press-fit-to-board connector : TYPE F

Description

- 8 or 8+2 Row female right angle connector with 88 signal contacts.
- Integrated pegs for guiding & polarization.
- Press - fit terminations.
- Non - shielded and shielded versions.
- Customized loading arrangements on request.
- Additional lower shield : see page 47.
- Board lay-out : see page 80.

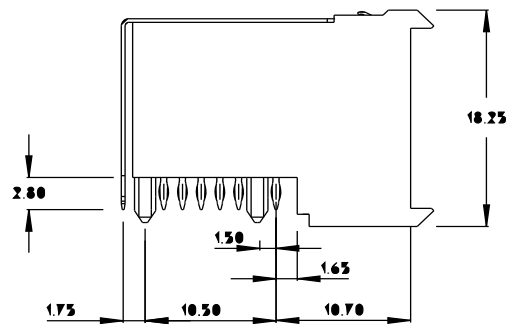
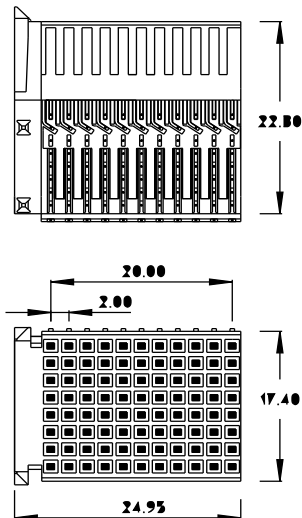

Standard product offer : with location pegs

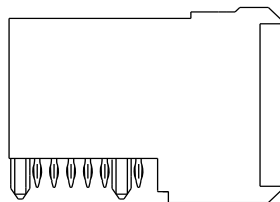

HM2R89PA8100N9
(non shielded)

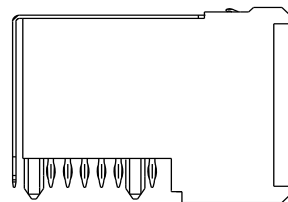

HM2R89PA8108N9
(top shielded only, 4 mm pitch)

Standard product offer : without location pegs

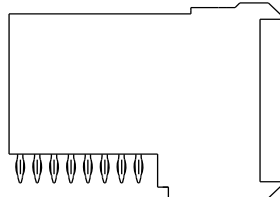

HM2R83PA8100N9
(non shielded)

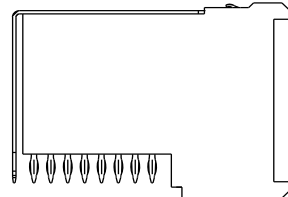

HM2R83PA8108N9
(top shielded only, 4 mm pitch)

Millipacs® HM

8+2 Row female signal right angle press-fit-to-board connector : TYPE FR (F Reversed, FCI terminology)

Description

- 8 or 8+2 Row female right angle connector with 88 signal contacts.
- Integrated pegs for guiding & polarization.
- Press - fit terminations.
- Non - shielded and shielded versions.
- Customized loading arrangements on request.
- Additional lower shield : see page 47.
- Board lay-out : see page 80.

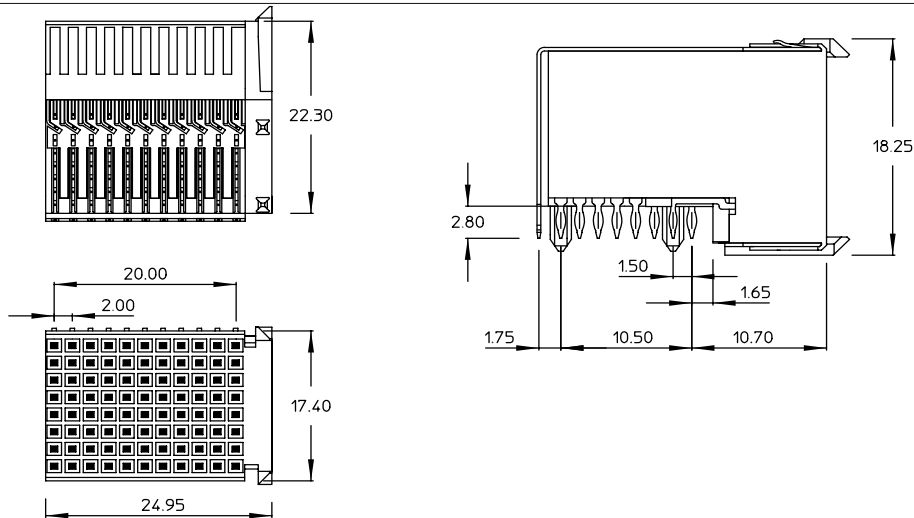
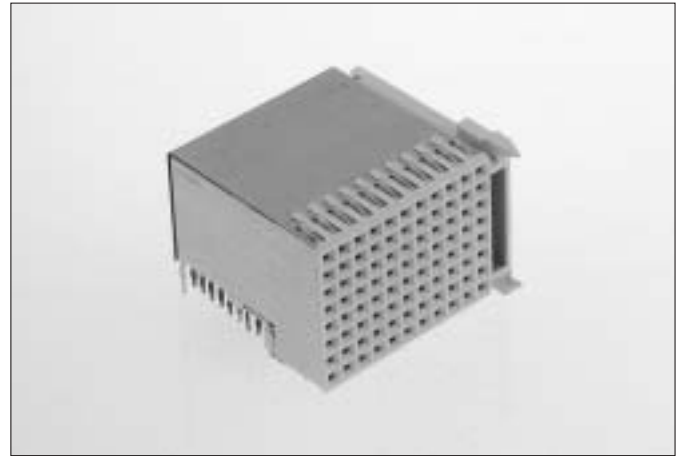

Standard product offer : with location pegs

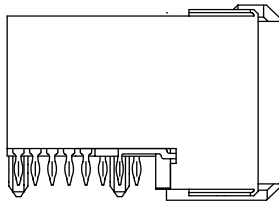

HM2R82PA8100N9
(non shielded)

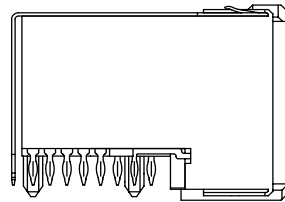

HM2R82PA8108N9
(top shielded only, 4 mm pitch)

Standard product offer : without location pegs

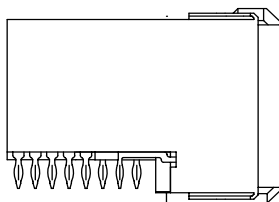

HM2R90PA8100N9
(non shielded)

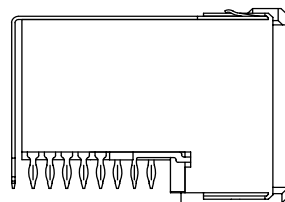

HM2R90PA8108N9
(top shielded only, 4 mm pitch)

Millipacs® HM

Rear lower shield : press-fit versions

Features

- FCI is offering the widest range in Hard Metric shielded connectors.
- Lower shields have to be ordered separately.
- 1-piece press-fit shields.
- Flat rock press-in operation.

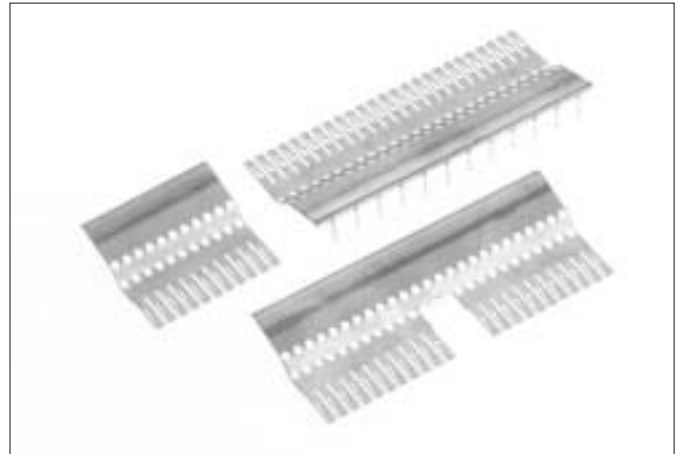

| Lower shield ordering information : | | |
|-------------------------------------|-----------------------|----------------|
| Description | Connector Partnumbers | Lower shield : |
| Type A | HM2R01PA5108N9 | HM2LS22A |
| | HM2R10PA5108N9 | HM2LS22A |
| Type B | HM2R02PA5108N9 | HM2LS25A |
| Type B22 | HM2R70PA5108N9 | HM2LS70A |
| Type B19 | HM2R71PA5108N9 | HM2LS71A |
| Type AB | HM2R65PA5108N9 | HM2LS22A |
| Type AB22 | HM2R66PA5108N9 | HM2LS66A |
| Type AB19 | HM2R67PA5108N9 | HM2LS67A |
| Type C | HM2R03PA5108N9 | HM2LS11A |
| | HM2R30PA5108N9 | HM2LS11A |
| Type CR | HM2R20PA5108N9 | HM2LS11A |
| | HM2R21PA5108N9 | HM2LS11A |
| Type M | HM2R05PA5108N9 | HM2LS11A |
| | HM2R50PA5108N9 | HM2LS11A |
| Type D | HM2R87PA8108N9 | HM2LS22A8 |
| | HM2R81PA8108N9 | HM2LS22A8 |
| Type E | HM2R88PA8108N9 | HM2LS25A8 |
| Type DE | HM2R95PA8108N9 | HM2LS22A8 |
| Type F | HM2R89PA8108N9 | HM2LS11A8 |
| | HM2R83PA8108N9 | HM2LS11A8 |
| Type FR | HM2R82PA8108N9 | HM2LS11A8 |
| | HM2R90PA8108N9 | HM2LS11A8 |

Pre-assembled top shielded + additional pressed-in lower shield

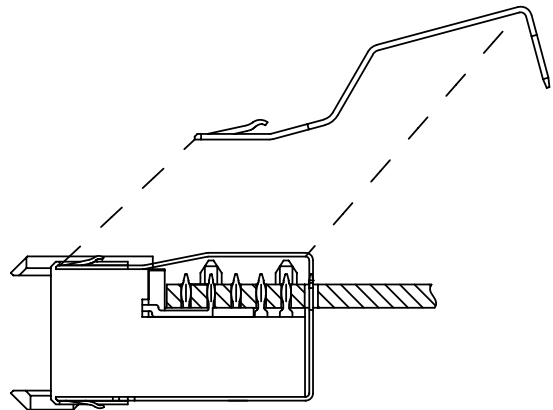

Features

- Pre-assembled top shield with 4.0 mm pitch, odd positioned, short terminations.
- Press-fitted lower shield with 4.0 mm pitch, even positioned, short terminations.
- Press operated.
- PCB thickness range : 1.4 mm – 3.2 mm.

Millipacs® HM

5+2 Row female straight press-fit-to-board connector : TYPE A

Description

- 5 or 5+2 Row female straight connector with 110 signal contacts.
- Integrated "MP" center for polarization and coding.
("MP" = multi purpose center)
- Press - fit terminations.
- Non - shielded and shielded versions.
- Short and rear plug-up terminations.
- Customized loading arrangements on request.
- Board lay-out : see page ...

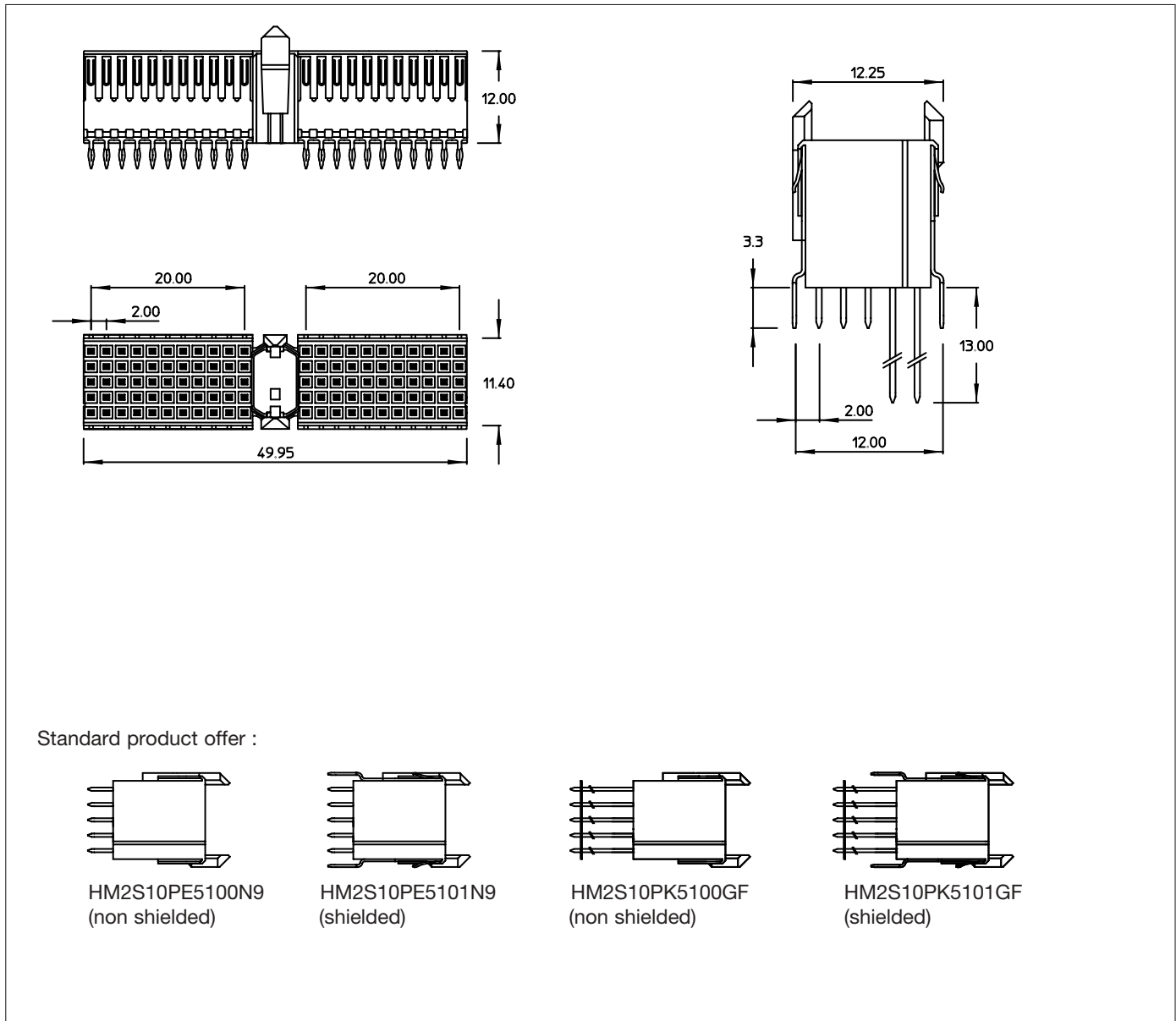
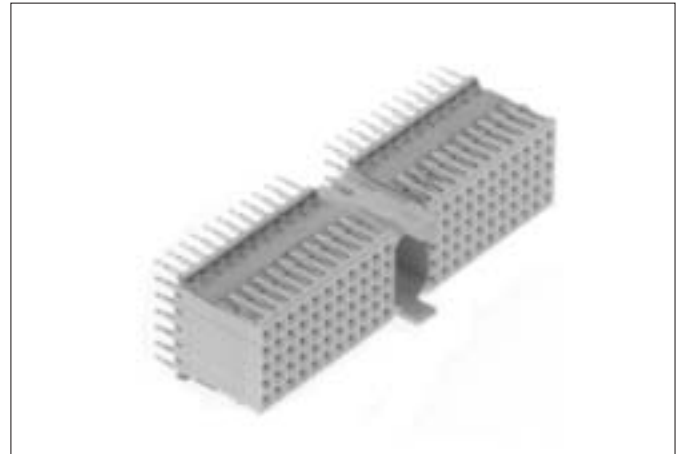

Millipacs® HM

5+2 Row female straight press-fit-to-board connector : TYPE B

Description

- 5 or 5+2 Row female straight connector with 125 signal contacts.
- Press - fit terminations.
- Non - shielded and shielded versions.
- Short and rear plug-up terminations.
- Customized loading arrangements on request.
- Board lay-out : see page 80.

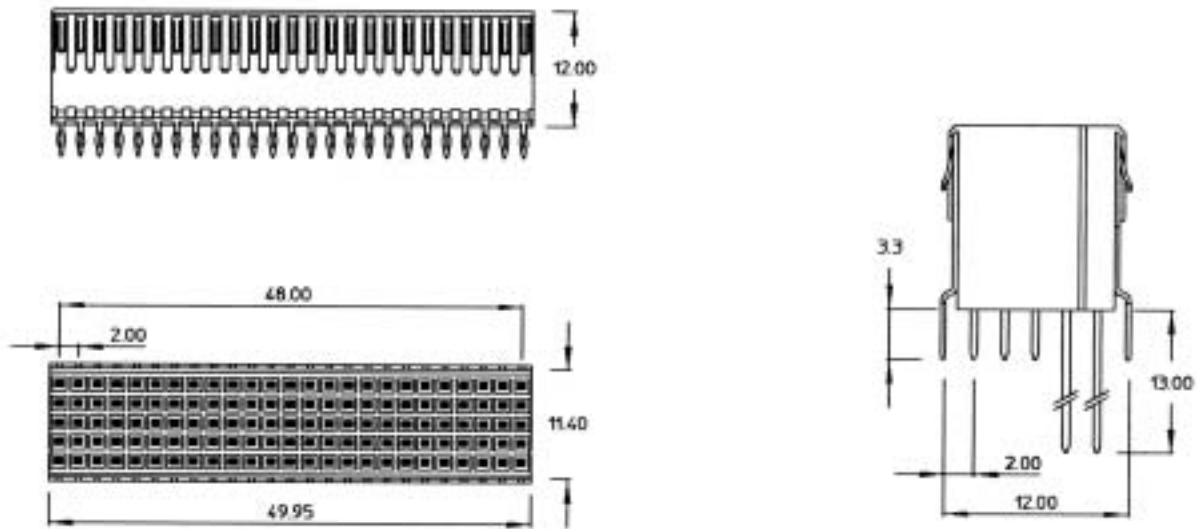
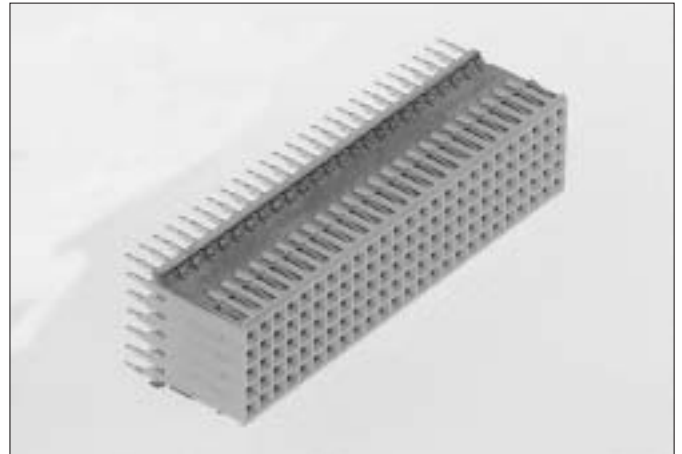

Standard product offer :

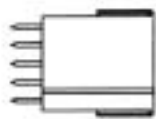

HM2S02PE5100N9
(non shielded)

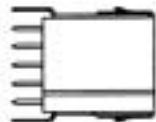

HM2S02PE5101N9
(shielded)

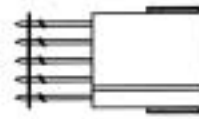

HM2S02PK5100GF
(non shielded)

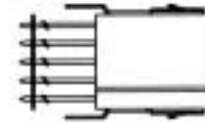

HM2S02PK5101GF
(shielded)

Millipacs[®] HM

5+2 Row female straight press-fit-to-board connector : TYPE B22

Description

- 5 or 5+2 Row female straight connector with 110 signal contacts.
- Press - fit terminations.
- Non - shielded and shielded versions.
- Short and rear plug-up terminations.
- Customized loading arrangements on request.
- Board lay-out : see page 80.

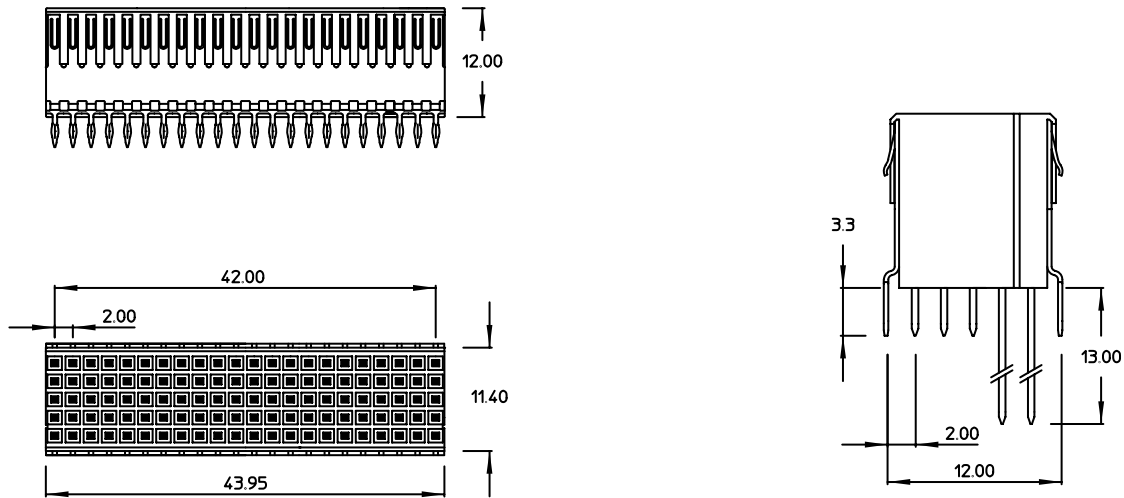
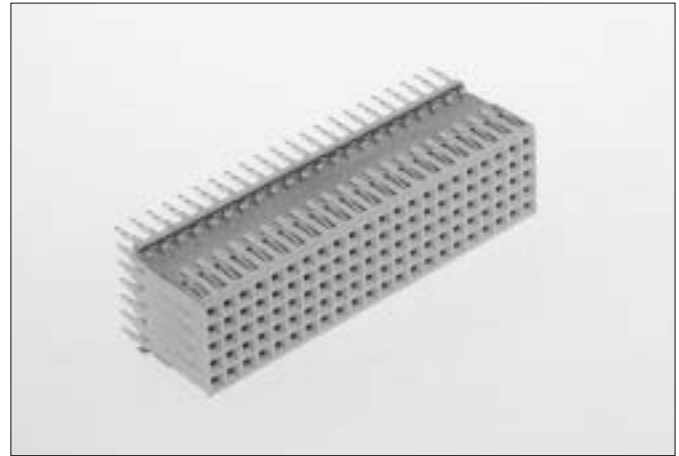

Standard product offer :

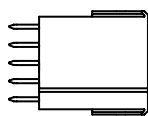

HM2S70PE5100N9
(non shielded)

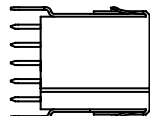

HM2S70PE5101N9
(shielded)

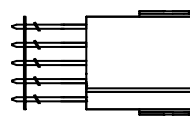

HM2S70PK5100GF
(non shielded)

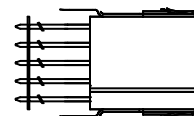

HM2S70PK5101GF
(shielded)

Millipacs® HM

5+2 Row female straight press-fit-to-board connector : TYPE B19

Description

- 5 or 5+2 Row female straight connector with 95 signal contacts.
- Press - fit terminations.
- Non - shielded and shielded versions.
- Short and rear plug-up terminations.
- Customized loading arrangements on request.
- Board lay-out : see page 80.

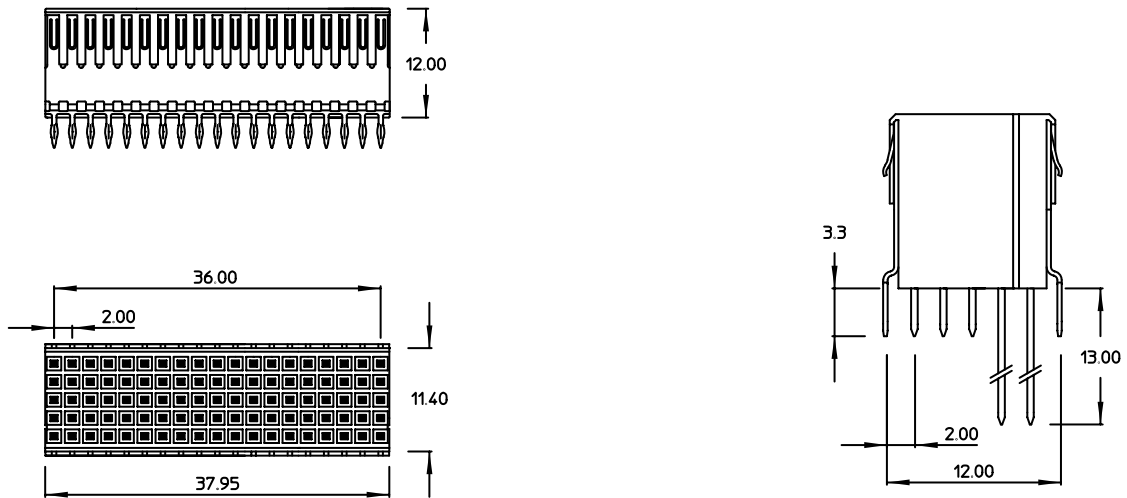
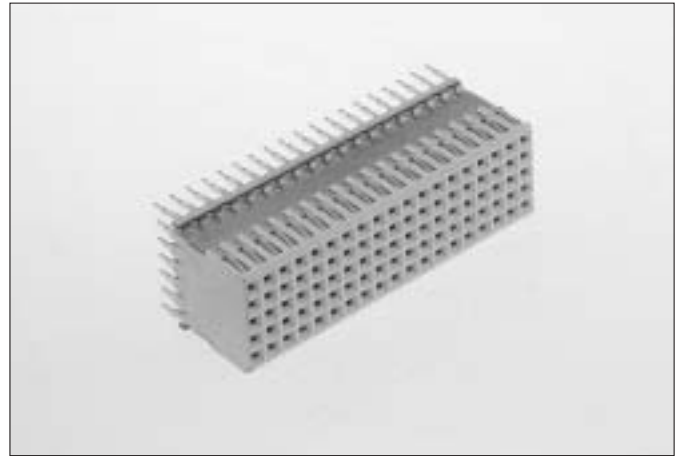

Standard product offer :

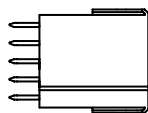

HM2S71PE5100N9
(non shielded)

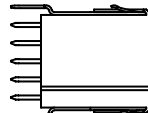

HM2S71PE5101N9
(shielded)

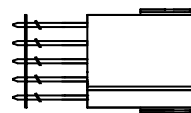

HM2S71PK5100GF
(non shielded)

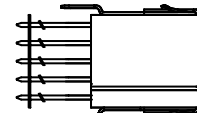

HM2S71PK5101GF
(shielded)

Millipacs® HM

5+2 Row female straight press-fit-to-board connector : TYPE C

Description

- 5 or 5+2 Row female straight connector with 55 signal contacts.
- Integrated pegs for guiding & polarization.
- Press - fit terminations.
- Non - shielded and shielded versions.
- Short and rear plug-up terminations.
- Customized loading arrangements on request.
- Board lay-out : see page 80.

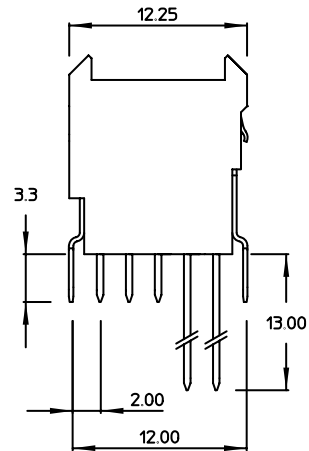
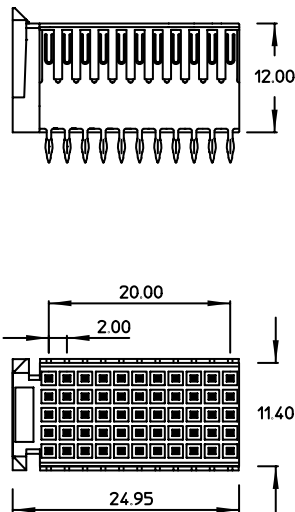
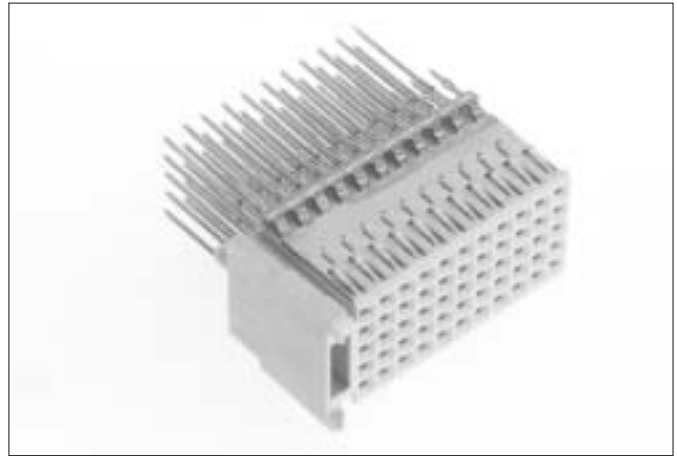

Standard product offer :

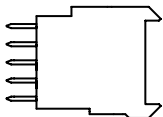

HM2S30PE5100N9
(non shielded)

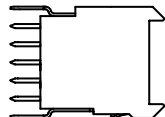

HM2S30PE5101N9
(shielded)

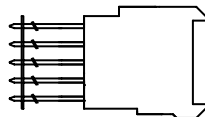

HM2S30PK5100GF
(non shielded)

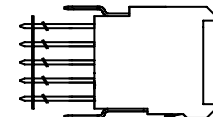

HM2S30PK5101GF
(shielded)

Millipacs® HM

5 Row male right angle press-fit-to-board connector : TYPE A

Description

- 5 or 5+1 Row male right angle connector with 110 signal contacts.
- Integrated "MP" center for polarization and coding.
("MP" = multi purpose center).
- Press - fit terminations.
- Non - shielded and top shielded versions.
- Customized loading arrangements on request.
- Board lay-out : see page 80.

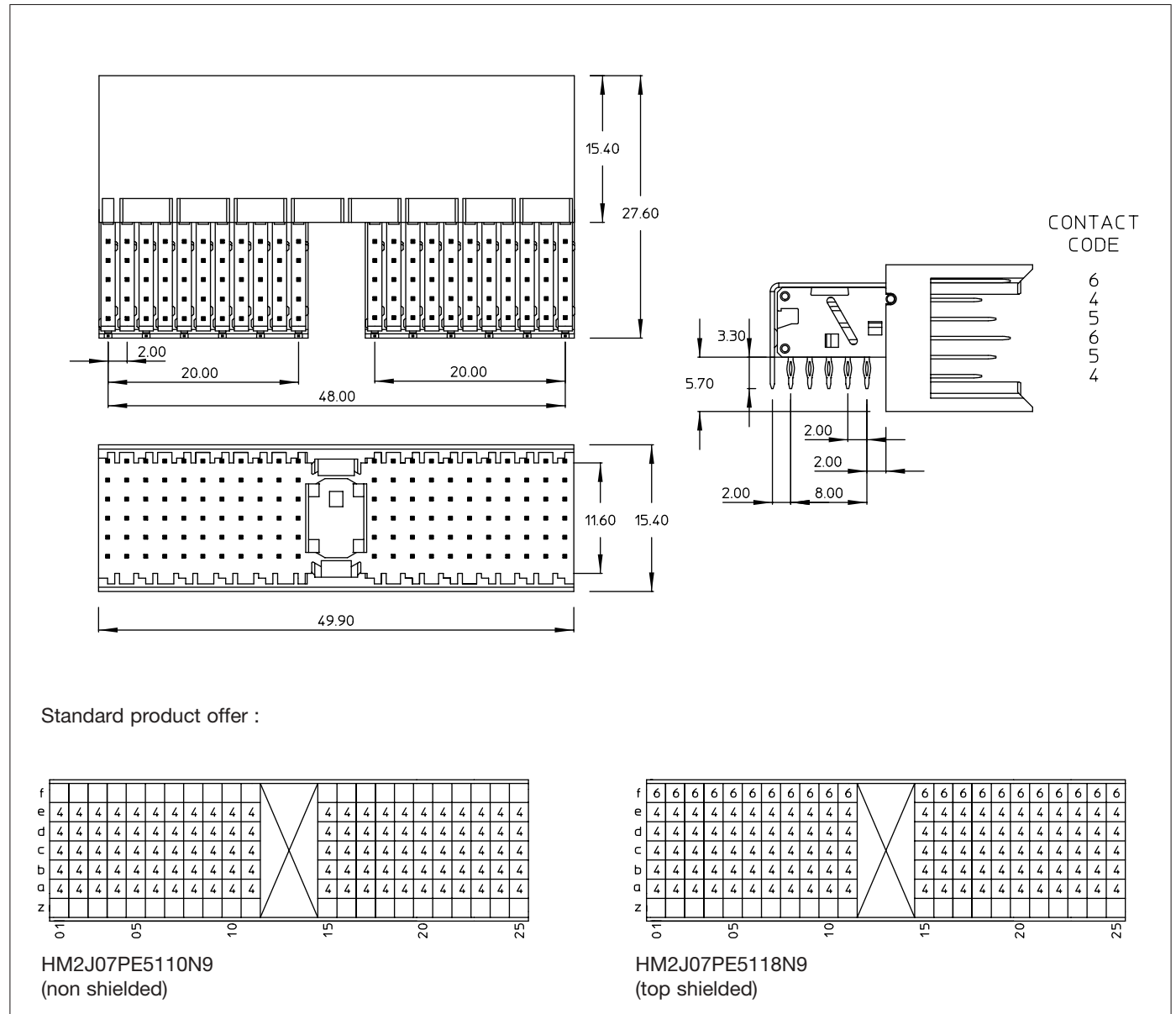
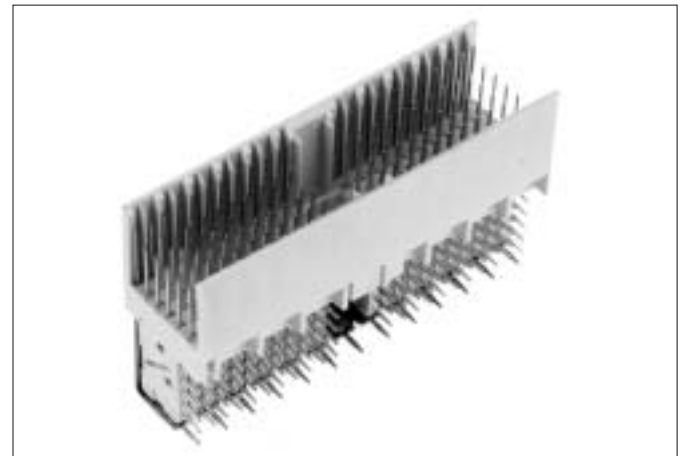

Millipacs® HM

5 Row male right angle press-fit-to-board connector : TYPE B

Description

- 5 or 5+1 Row male right angle connector with 125 signal contacts.
- Press - fit terminations.
- Non - shielded and top shielded versions.
- Customized loading arrangements on request.
- Board lay-out : see page 80.

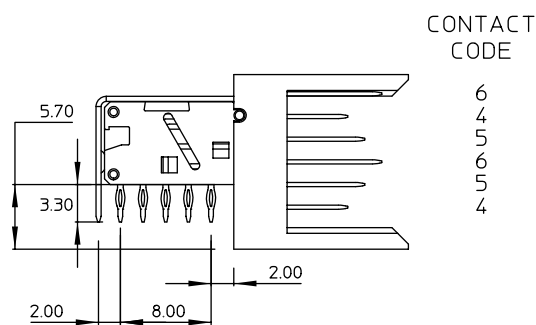
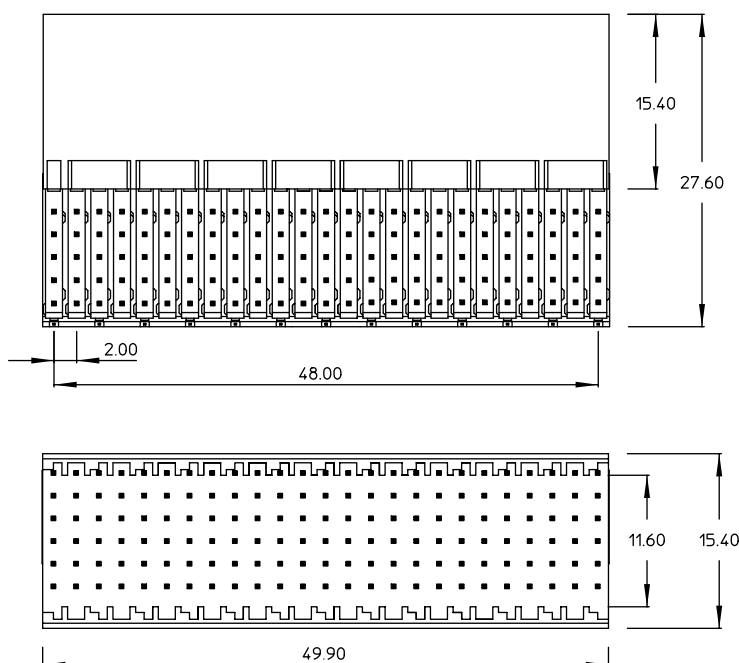
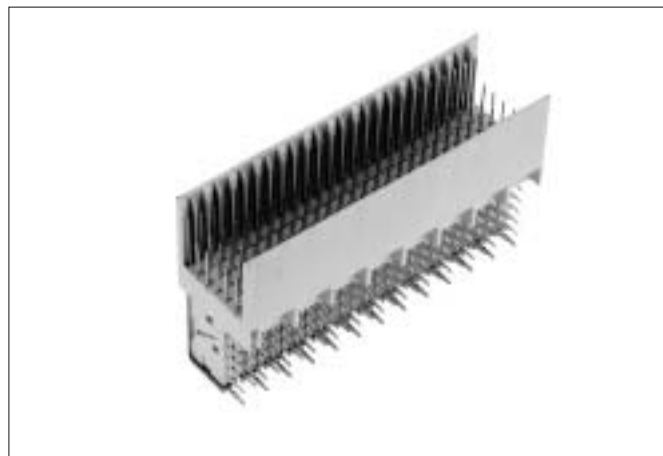

Standard product offer :

| | | | | | | | | | | | | | | | | | | | | | | | | | |
|---|----|----|----|----|----|----|---|---|---|---|---|---|---|---|---|---|---|---|---|---|---|---|---|---|---|
| f | | | | | | | | | | | | | | | | | | | | | | | | | |
| e | 4 | 4 | 4 | 4 | 4 | 4 | 4 | 4 | 4 | 4 | 4 | 4 | 4 | 4 | 4 | 4 | 4 | 4 | 4 | 4 | 4 | 4 | 4 | 4 | 4 |
| d | 4 | 4 | 4 | 4 | 4 | 4 | 4 | 4 | 4 | 4 | 4 | 4 | 4 | 4 | 4 | 4 | 4 | 4 | 4 | 4 | 4 | 4 | 4 | 4 | 4 |
| c | 4 | 4 | 4 | 4 | 4 | 4 | 4 | 4 | 4 | 4 | 4 | 4 | 4 | 4 | 4 | 4 | 4 | 4 | 4 | 4 | 4 | 4 | 4 | 4 | 4 |
| b | 4 | 4 | 4 | 4 | 4 | 4 | 4 | 4 | 4 | 4 | 4 | 4 | 4 | 4 | 4 | 4 | 4 | 4 | 4 | 4 | 4 | 4 | 4 | 4 | 4 |
| a | 4 | 4 | 4 | 4 | 4 | 4 | 4 | 4 | 4 | 4 | 4 | 4 | 4 | 4 | 4 | 4 | 4 | 4 | 4 | 4 | 4 | 4 | 4 | 4 | 4 |
| z | | | | | | | | | | | | | | | | | | | | | | | | | |
| | 01 | 05 | 10 | 15 | 20 | 25 | | | | | | | | | | | | | | | | | | | |

HM2J08PE5110N9
(non shielded)

| | | | | | | | | | | | | | | | | | | | | | | | | | |
|---|----|----|----|----|----|----|---|---|---|---|---|---|---|---|---|---|---|---|---|---|---|---|---|---|---|
| f | 6 | 6 | 6 | 6 | 6 | 6 | 6 | 6 | 6 | 6 | 6 | 6 | 6 | 6 | 6 | 6 | 6 | 6 | 6 | 6 | 6 | 6 | 6 | 6 | 6 |
| e | 4 | 4 | 4 | 4 | 4 | 4 | 4 | 4 | 4 | 4 | 4 | 4 | 4 | 4 | 4 | 4 | 4 | 4 | 4 | 4 | 4 | 4 | 4 | 4 | 4 |
| d | 4 | 4 | 4 | 4 | 4 | 4 | 4 | 4 | 4 | 4 | 4 | 4 | 4 | 4 | 4 | 4 | 4 | 4 | 4 | 4 | 4 | 4 | 4 | 4 | 4 |
| c | 4 | 4 | 4 | 4 | 4 | 4 | 4 | 4 | 4 | 4 | 4 | 4 | 4 | 4 | 4 | 4 | 4 | 4 | 4 | 4 | 4 | 4 | 4 | 4 | 4 |
| b | 4 | 4 | 4 | 4 | 4 | 4 | 4 | 4 | 4 | 4 | 4 | 4 | 4 | 4 | 4 | 4 | 4 | 4 | 4 | 4 | 4 | 4 | 4 | 4 | 4 |
| a | 4 | 4 | 4 | 4 | 4 | 4 | 4 | 4 | 4 | 4 | 4 | 4 | 4 | 4 | 4 | 4 | 4 | 4 | 4 | 4 | 4 | 4 | 4 | 4 | 4 |
| z | | | | | | | | | | | | | | | | | | | | | | | | | |
| | 01 | 05 | 10 | 15 | 20 | 25 | | | | | | | | | | | | | | | | | | | |

HM2J08PE5118N9
(top shielded)

Millipacs® HM

5 Row male right angle press-fit-to-board connector : TYPE B22

Description

- 5 or 5+1 Row male right angle connector with 110 signal contacts.
- Press - fit terminations.
- Non - shielded and top shielded versions.
- Customized loading arrangements on request.
- Board lay-out : see page 80.

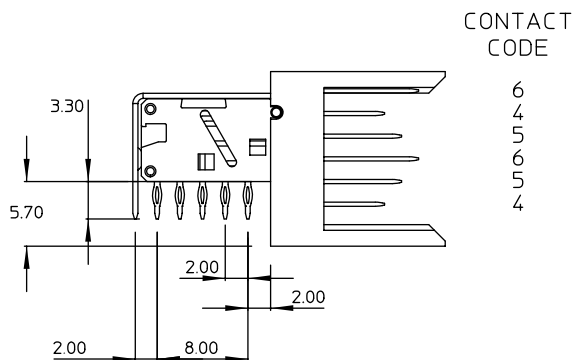
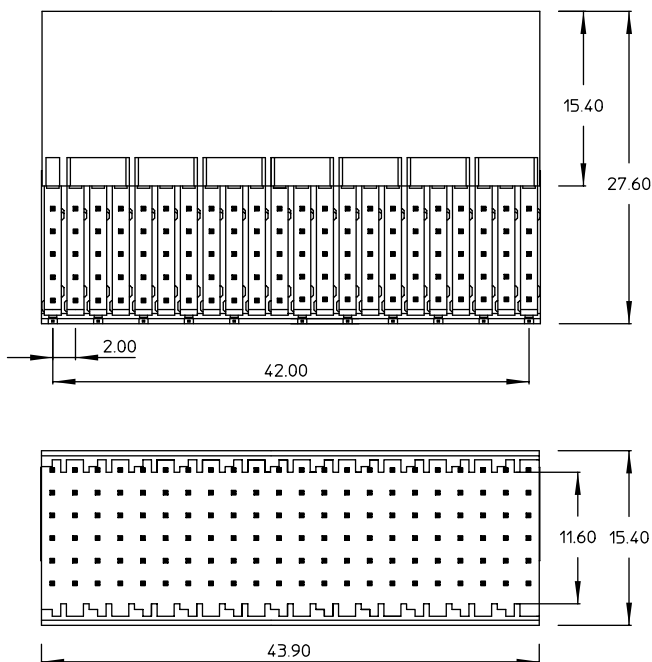
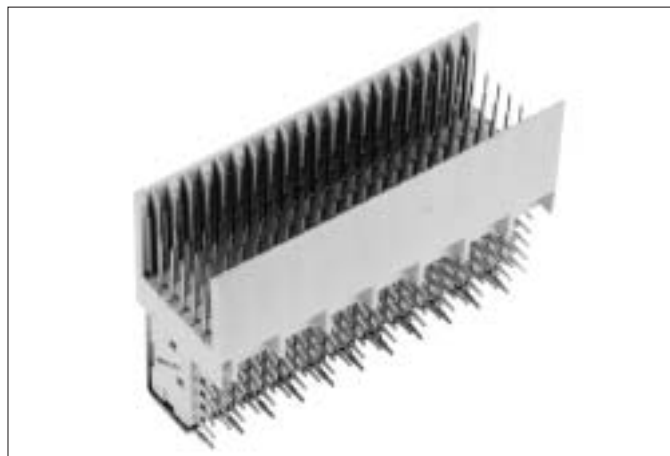

Standard product offer :

| | | | | | | | | | | | | | | | | | | | | |
|---|----|----|----|----|----|---|---|---|---|---|---|---|---|---|---|---|---|---|---|---|
| f | | | | | | | | | | | | | | | | | | | | |
| e | 4 | 4 | 4 | 4 | 4 | 4 | 4 | 4 | 4 | 4 | 4 | 4 | 4 | 4 | 4 | 4 | 4 | 4 | 4 | 4 |
| d | 4 | 4 | 4 | 4 | 4 | 4 | 4 | 4 | 4 | 4 | 4 | 4 | 4 | 4 | 4 | 4 | 4 | 4 | 4 | 4 |
| c | 4 | 4 | 4 | 4 | 4 | 4 | 4 | 4 | 4 | 4 | 4 | 4 | 4 | 4 | 4 | 4 | 4 | 4 | 4 | 4 |
| b | 4 | 4 | 4 | 4 | 4 | 4 | 4 | 4 | 4 | 4 | 4 | 4 | 4 | 4 | 4 | 4 | 4 | 4 | 4 | 4 |
| a | 4 | 4 | 4 | 4 | 4 | 4 | 4 | 4 | 4 | 4 | 4 | 4 | 4 | 4 | 4 | 4 | 4 | 4 | 4 | 4 |
| z | | | | | | | | | | | | | | | | | | | | |
| | 01 | 05 | 10 | 15 | 20 | | | | | | | | | | | | | | | |

HM2J70PE5110N9
(non shielded)

| | | | | | | | | | | | | | | | | | | | | |
|---|----|----|----|----|----|---|---|---|---|---|---|---|---|---|---|---|---|---|---|---|
| f | 6 | 6 | 6 | 6 | 6 | 6 | 6 | 6 | 6 | 6 | 6 | 6 | 6 | 6 | 6 | 6 | 6 | 6 | 6 | 6 |
| e | 4 | 4 | 4 | 4 | 4 | 4 | 4 | 4 | 4 | 4 | 4 | 4 | 4 | 4 | 4 | 4 | 4 | 4 | 4 | 4 |
| d | 4 | 4 | 4 | 4 | 4 | 4 | 4 | 4 | 4 | 4 | 4 | 4 | 4 | 4 | 4 | 4 | 4 | 4 | 4 | 4 |
| c | 4 | 4 | 4 | 4 | 4 | 4 | 4 | 4 | 4 | 4 | 4 | 4 | 4 | 4 | 4 | 4 | 4 | 4 | 4 | 4 |
| b | 4 | 4 | 4 | 4 | 4 | 4 | 4 | 4 | 4 | 4 | 4 | 4 | 4 | 4 | 4 | 4 | 4 | 4 | 4 | 4 |
| a | 4 | 4 | 4 | 4 | 4 | 4 | 4 | 4 | 4 | 4 | 4 | 4 | 4 | 4 | 4 | 4 | 4 | 4 | 4 | 4 |
| z | | | | | | | | | | | | | | | | | | | | |
| | 01 | 05 | 10 | 15 | 20 | | | | | | | | | | | | | | | |

HM2J70PE5118N9
(top shielded)

Millipacs[®] HM

5 Row male right angle press-fit-to-board connector : TYPE B19

Description

- 5 or 5+1 Row male right angle connector with 95 signal contacts.
- Press - fit terminations.
- Non - shielded and top shielded versions.
- Customized loading arrangements on request.
- Board lay-out : see page 80.

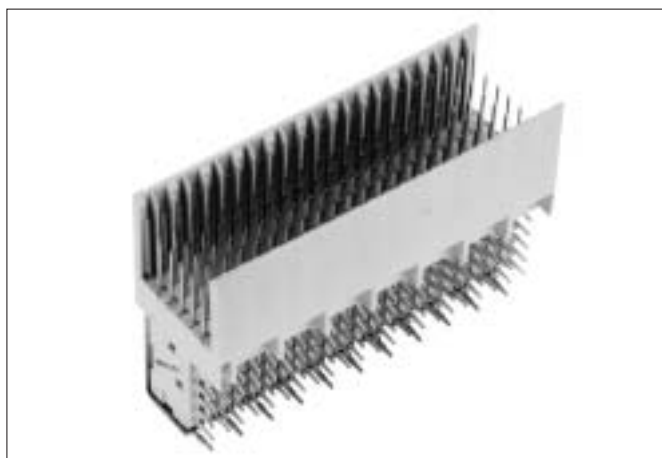

Standard product offer :

| | | | | | | | | | | | | | | | | | | | | | | |
|---|----|----|----|----|---|---|---|---|---|---|---|---|---|---|---|---|---|---|---|---|---|---|
| f | | | | | | | | | | | | | | | | | | | | | | |
| e | 4 | 4 | 4 | 4 | 4 | 4 | 4 | 4 | 4 | 4 | 4 | 4 | 4 | 4 | 4 | 4 | 4 | 4 | 4 | 4 | 4 | 4 |
| d | 4 | 4 | 4 | 4 | 4 | 4 | 4 | 4 | 4 | 4 | 4 | 4 | 4 | 4 | 4 | 4 | 4 | 4 | 4 | 4 | 4 | 4 |
| c | 4 | 4 | 4 | 4 | 4 | 4 | 4 | 4 | 4 | 4 | 4 | 4 | 4 | 4 | 4 | 4 | 4 | 4 | 4 | 4 | 4 | 4 |
| b | 4 | 4 | 4 | 4 | 4 | 4 | 4 | 4 | 4 | 4 | 4 | 4 | 4 | 4 | 4 | 4 | 4 | 4 | 4 | 4 | 4 | 4 |
| a | 4 | 4 | 4 | 4 | 4 | 4 | 4 | 4 | 4 | 4 | 4 | 4 | 4 | 4 | 4 | 4 | 4 | 4 | 4 | 4 | 4 | 4 |
| z | | | | | | | | | | | | | | | | | | | | | | |
| | 01 | 05 | 10 | 15 | | | | | | | | | | | | | | | | | | |

HM2J71PE5110N9
(non shielded)

| | | | | | | | | | | | | | | | | | | | | | | | | |
|---|----|----|----|----|---|---|---|---|---|---|---|---|---|---|---|---|---|---|---|---|---|---|---|---|
| f | 6 | 6 | 6 | 6 | 6 | 6 | 6 | 6 | 6 | 6 | 6 | 6 | 6 | 6 | 6 | 6 | 6 | 6 | 6 | 6 | 6 | 6 | 6 | 6 |
| e | 4 | 4 | 4 | 4 | 4 | 4 | 4 | 4 | 4 | 4 | 4 | 4 | 4 | 4 | 4 | 4 | 4 | 4 | 4 | 4 | 4 | 4 | 4 | 4 |
| d | 4 | 4 | 4 | 4 | 4 | 4 | 4 | 4 | 4 | 4 | 4 | 4 | 4 | 4 | 4 | 4 | 4 | 4 | 4 | 4 | 4 | 4 | 4 | 4 |
| c | 4 | 4 | 4 | 4 | 4 | 4 | 4 | 4 | 4 | 4 | 4 | 4 | 4 | 4 | 4 | 4 | 4 | 4 | 4 | 4 | 4 | 4 | 4 | 4 |
| b | 4 | 4 | 4 | 4 | 4 | 4 | 4 | 4 | 4 | 4 | 4 | 4 | 4 | 4 | 4 | 4 | 4 | 4 | 4 | 4 | 4 | 4 | 4 | 4 |
| a | 4 | 4 | 4 | 4 | 4 | 4 | 4 | 4 | 4 | 4 | 4 | 4 | 4 | 4 | 4 | 4 | 4 | 4 | 4 | 4 | 4 | 4 | 4 | 4 |
| z | | | | | | | | | | | | | | | | | | | | | | | | |
| | 01 | 05 | 10 | 15 | | | | | | | | | | | | | | | | | | | | |

HM2J71PE5118N9
(top shielded)

Millipacs® HM

5 Row male right angle press-fit-to-board connector : TYPE C

Description

- 5 or 5+1 Row male right angle connector with 55 signal contacts.
- Integrated area for guiding & polarization.
- Press - fit terminations.
- Non - shielded and top shielded versions.
- Customized loading arrangements on request.
- Board lay-out : see page 80.

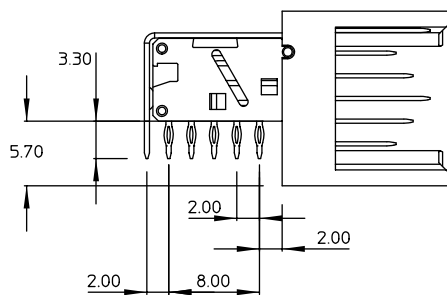
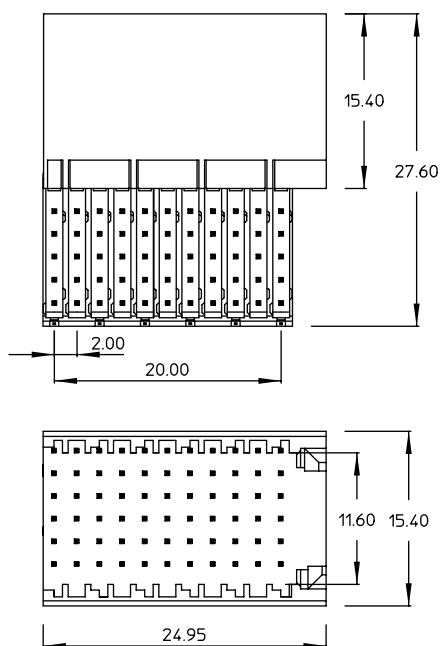
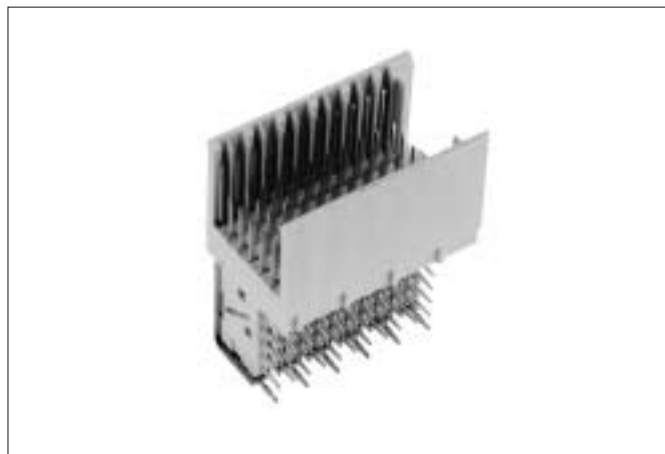

CONTACT
CODE

6
4
5
6
5
4

Standard product offer :

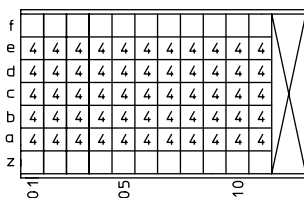

HM2J09PE5110N9
(non shielded)

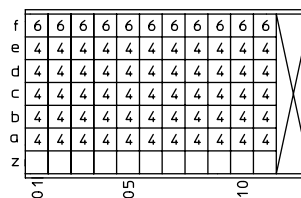

HM2J09PE5118N9
(top shielded)

Millipacs® HM

5 Row Input / Output non-shielded cable connectors : LF types

Description

- 5 Row cable connector with 10 or 20 signal contacts.
- Transversal mounting on the pin array.
- 4 - Contact point IDC configuration for discrete wires.
- Individual strain relief per contact.
- AWG 26 – AWG 30.
- Accommodates solid and stranded wires.
- Integrated polarization.
- Not stackable.
- Field installable and repairable.

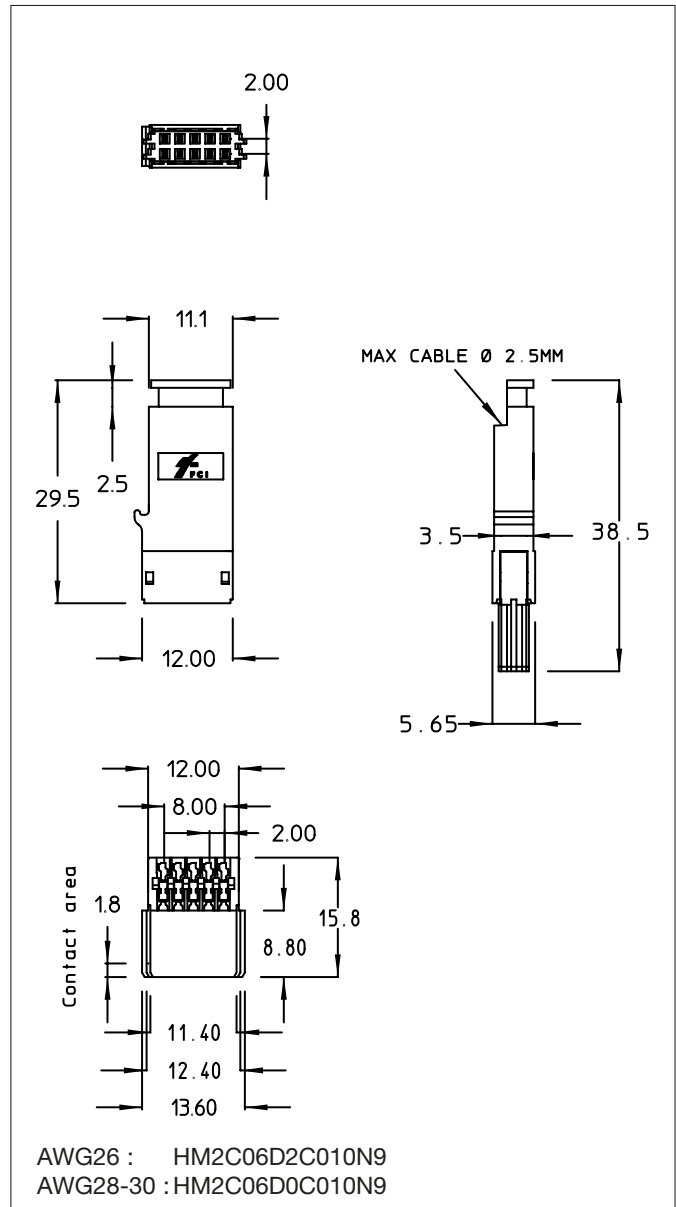
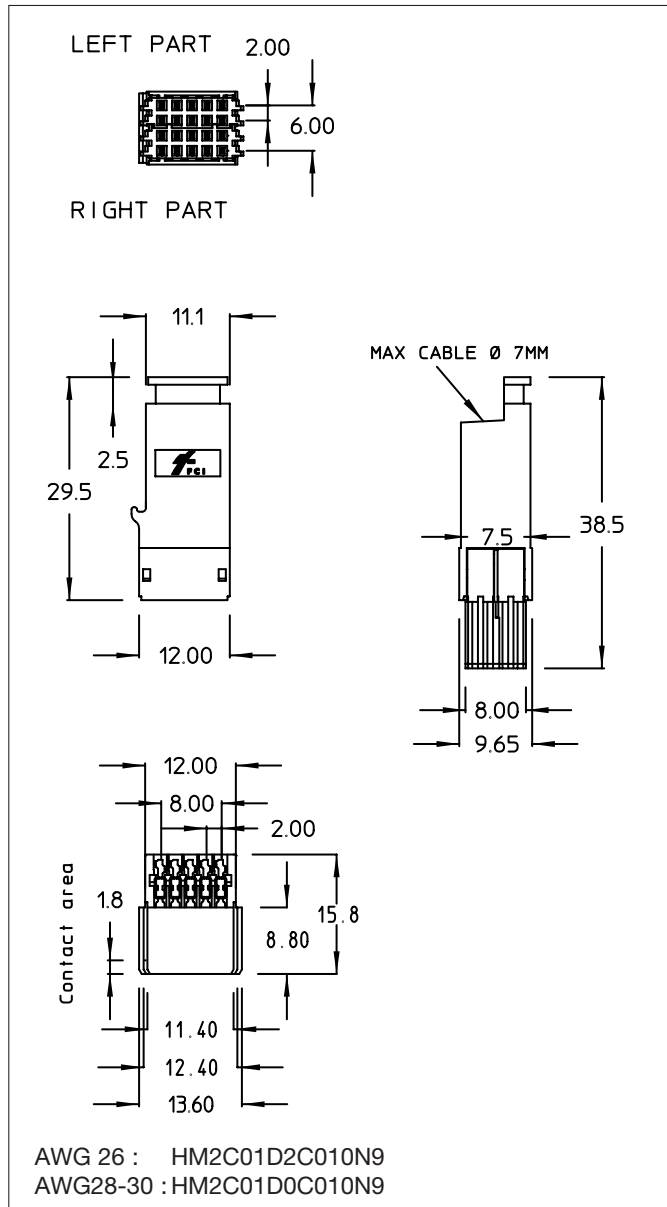
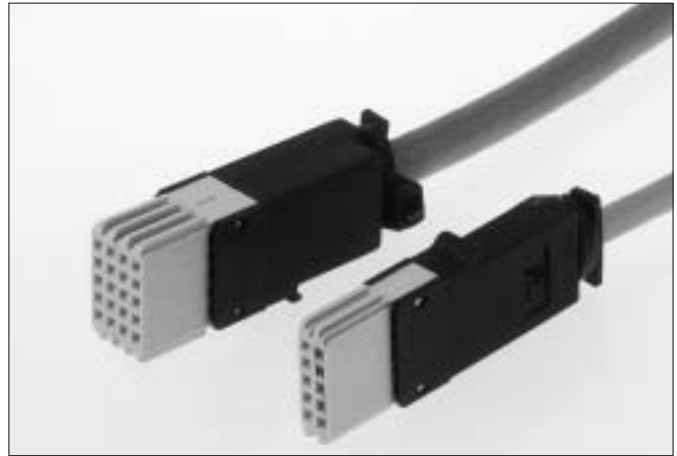

Millipacs® HM

5+2 Row Input / Output shielded cable connectors : LF types

Description

- 5+2 Row shielded cable connector with 10, 20, 30 or 40 signal contacts.
- Transversal mounting on the pin array.
- 4 - Contact point IDC configuration for discrete wires.
- Individual strain relief per contact.
- AWG 26 – AWG 30.
- Accommodates solid and stranded wires.
- Integrated polarization.
- Cable braid <-> Metal cover : crimp connected.
- Fully stackable.
- Polarized plastic snap-on cover.
- Field installable and repairable.

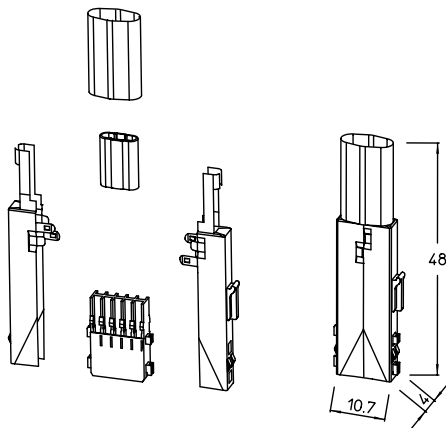
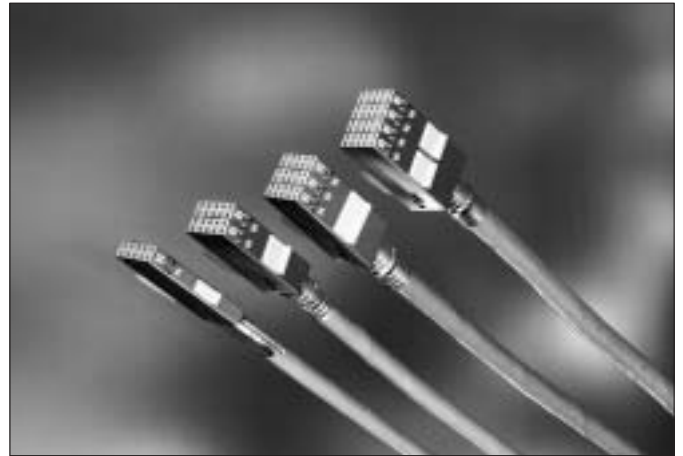

2 x 5 positions

AWG 26 : HM2C09D2C011N9
AWG 28-30 : HM2C09D0C011N9

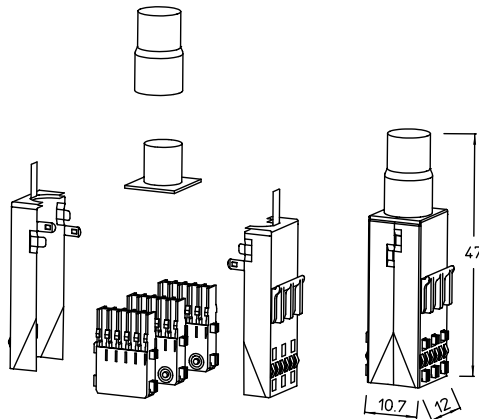

6 x 5 positions

AWG 26 : HM2C11D2C011N9
AWG 28-30 : HM2C11D0C011N9

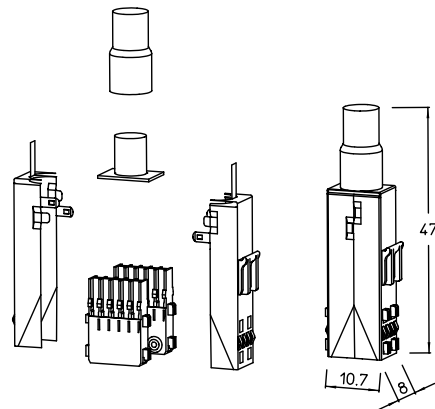

4 x 5 positions

AWG 26 : HM2C10D2C011N9
AWG 28-30 : HM2C10D0C011N9

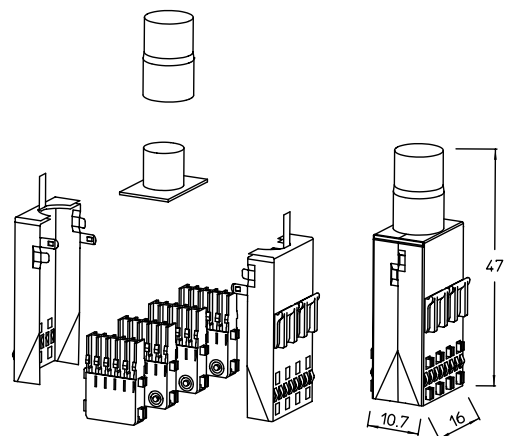

8 x 5 positions

AWG 26 : HM2C12D2C011N9
AWG 28-30 : HM2C12D0C011N9

Millipacs® HM

5+2 Row Board to Board shrouds : ALL TYPES

Description

- 5 or 5+2 Row empty rear plug-up shrouds for midplane and/or butterfly applications.
- Integrated "MP" center for polarization and coding or guiding area, except for type B.
- Shroud retention achieved by forced-fit over plug tails.
- No additional mechanical fixation.
- Moulded-on spacers.
- Same mating conditions as for male headers.

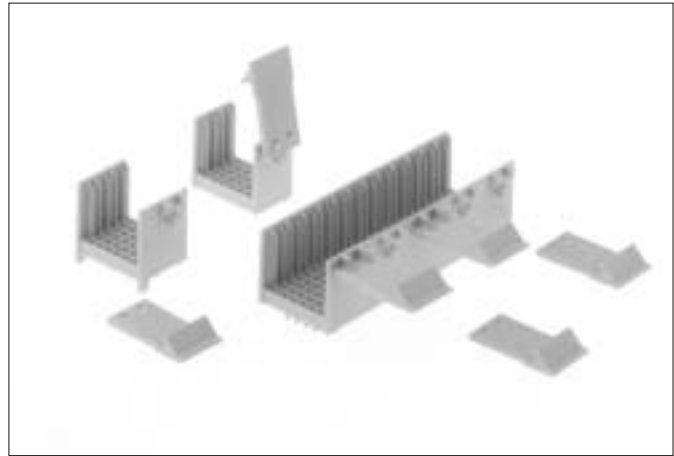

How to define the correct shroud height?

- L1: shroud bottom height (stand-off included)
- B: backplane thickness
- L2: rear pin mating level (5.3/6.8/8.3 mm)
- L: total pin length rear plug-up (13.0/14.5/16.0)

$$L1 = L - L2 - B$$

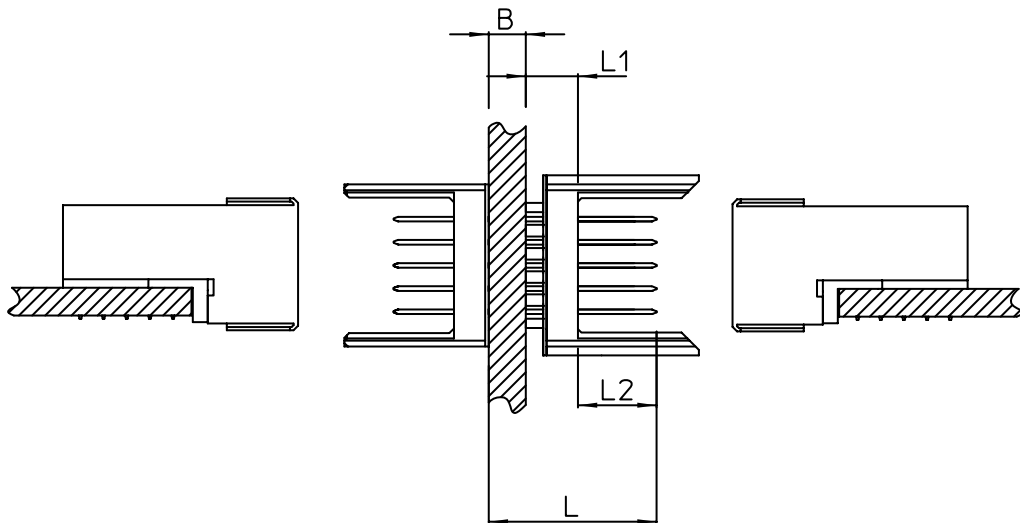

Available shroud heights :

| L1 | 3.0 mm | 3.9 mm | 4.1 mm | 4.3 mm | 4.5 mm | 4.7 mm | 4.9 mm | 5.2 mm | 6.0 mm |
|----|--------|--------|--------|--------|--------|--------|--------|--------|--------|
| □□ | - | 09 | 11 | 13 | 15 | 17 | 19 | 22 | 30 |

* Remark : □□ in part number refers to the number code in the table.

Millipacs® HM

Standard product offer :

HM2H06P1□□ (type 5X5)

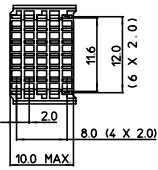

HM2H09P1□□ (type C)

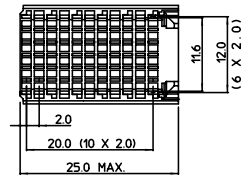

HM2H42P1□□ (type 6X5)

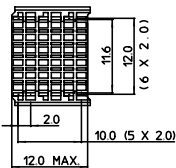

HM2H80P1□□ (type CR)

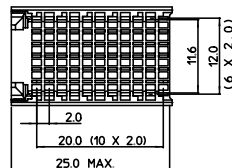

HM2H07P1□□ (type A)

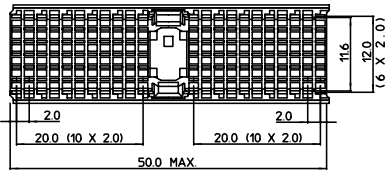

HM2H65P1□□ (type AB)

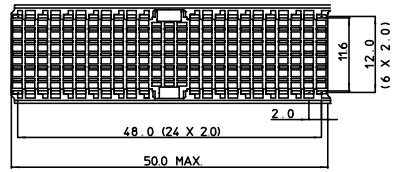

HM2H08P1□□ (type B)

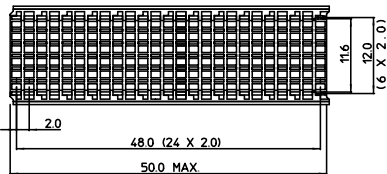

HM2H66P1□□ (type AB22)

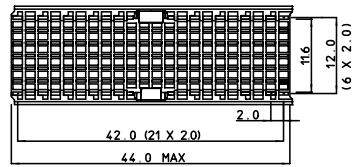

HM2H70P1□□ (type B22)

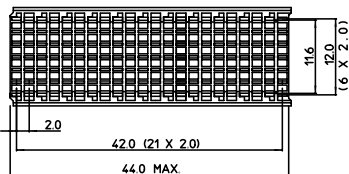

HM2H67P1□□ (type AB19)

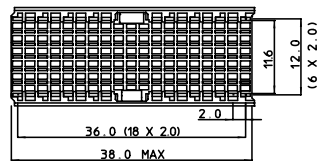

HM2H71P1□□ (type B19)

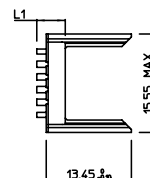
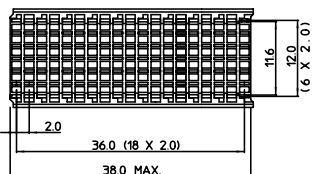

Millipacs® HM

5+2 Row Cable to Board shrouds : ALL TYPES

Description

- 5 or 5+2 Row empty rear plug-up shrouds for cable connector applications.
- Integrated polarization ribs.
- Moulded-on locking key features; locking key to be ordered separately.
- Shroud retention achieved by forced-fit over plug tails.
- No additional mechanical fixation.
- Moulded-on spacers.
- Correct spacer height definition : see page 60.
- Available spacer heights : see page 60.

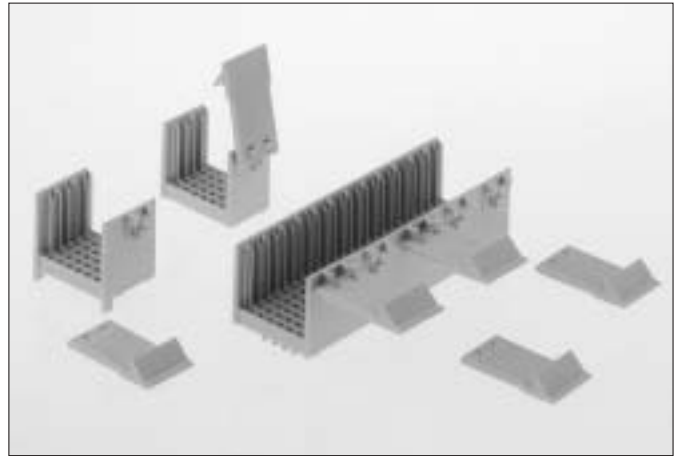

Locking key : HM2LK1

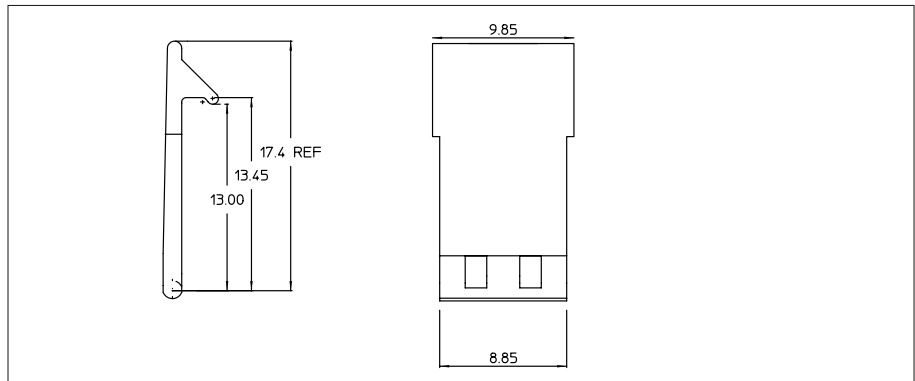

Standard product offer :

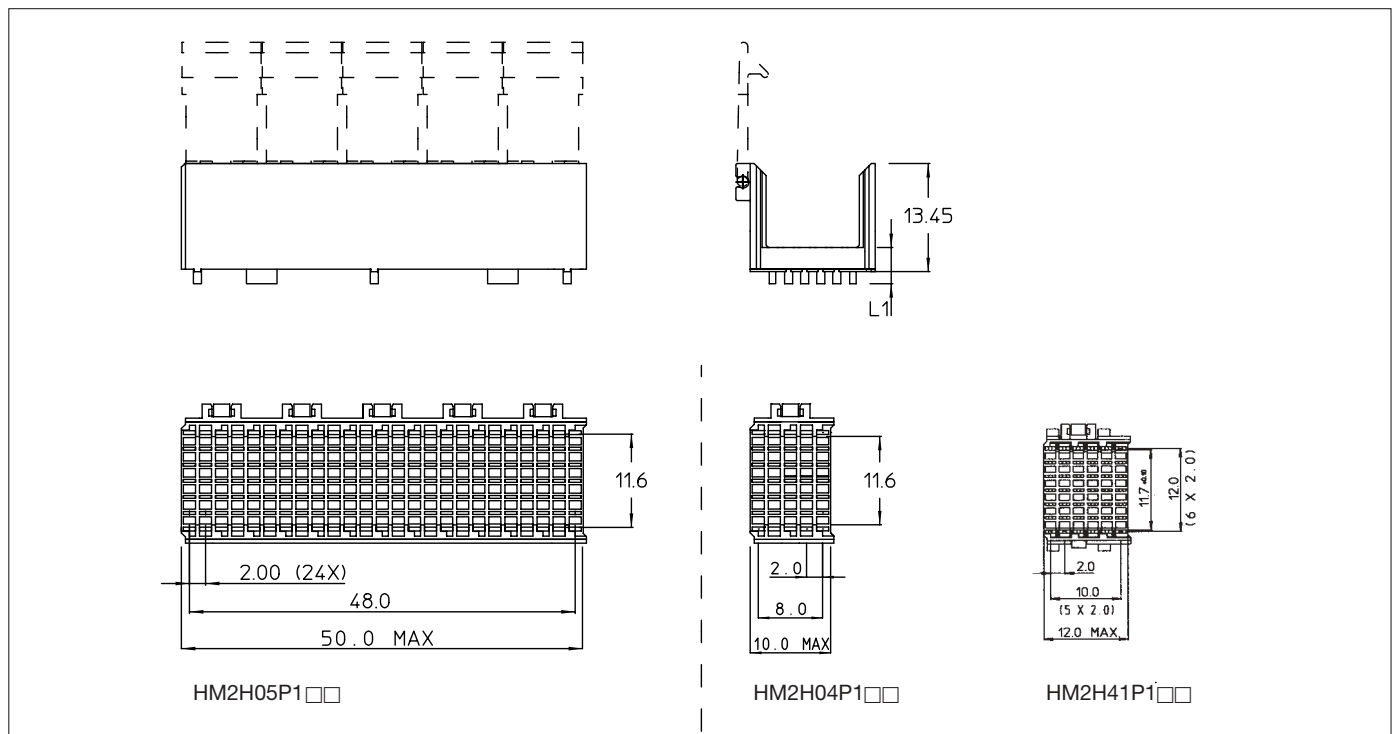

Millipacs® HM

8 and 8+2 Row Board to Board shrouds : ALL TYPES

Description

- 8 or 8+2 Row empty rear plug-up shrouds for midplane and/or butterfly applications.
- Integrated "MP" center for polarization and coding or guiding area, except for type E.
- Shroud retention achieved by forced-fit over plug tails.
- No additional mechanical fixation.
- Moulded-on spacers.
- Same mating conditions as for male headers.
- Additional guiding pin area integrated in type D.
- correct shroud height definition : see page 60.
- Available spacer heights : see page 60.

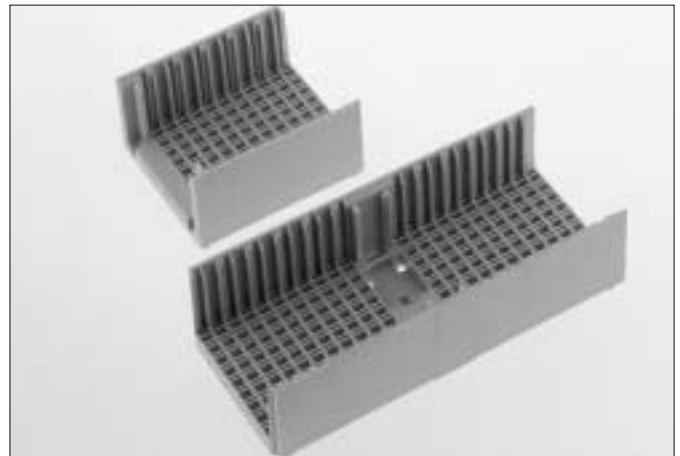

Standard product offer :

HM2H87P1□□ (type D)

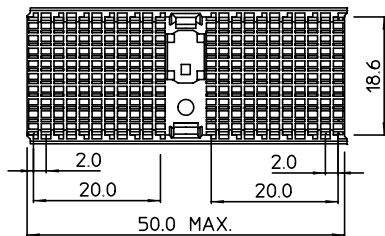

HM2H89P1□□ (type F)

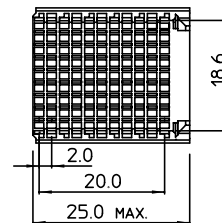

HM2H88P1□□ (type E)

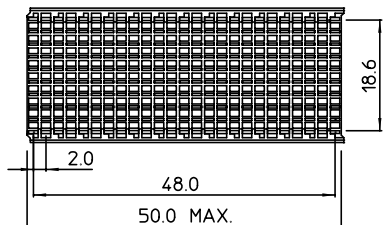

HM2H82P1□□ (type FR)

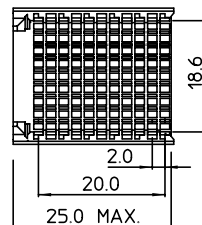

HM2H95P1□□ (type DE)

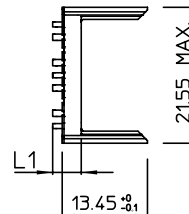
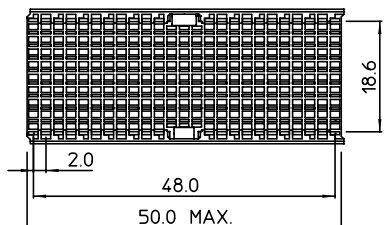

Millipacs[®] HM

ESD, Power and Guiding hardware

Description

- Stand-alone system to be used at any location within a connector configuration.
- Stackable system.
- Current rating : 10 A max.
- Guiding & pre-mating : 12 mm in advance of level 3 signal contacts.
- Different pin lengths available on request.



HM2G01

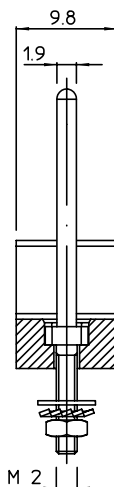
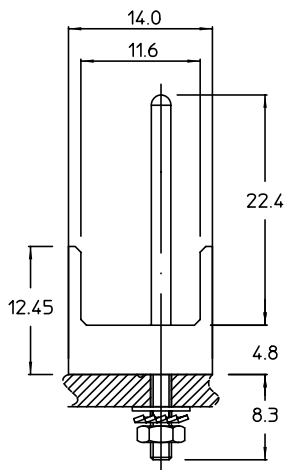

BACK-PLANE LAY-OUT
COMPONENT SIDE

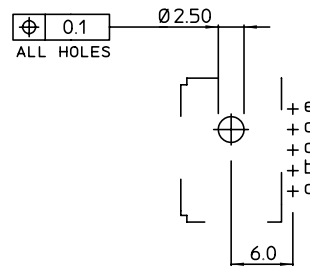

HM2G02

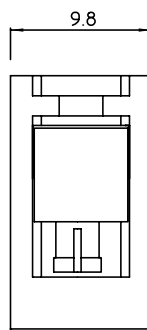
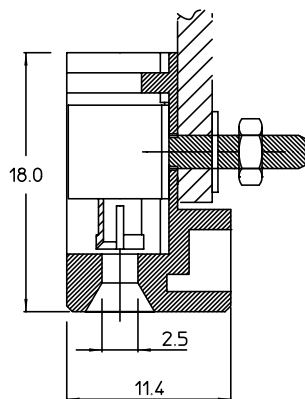

PCB-HOLE LAYOUT
COMPONENT SIDE

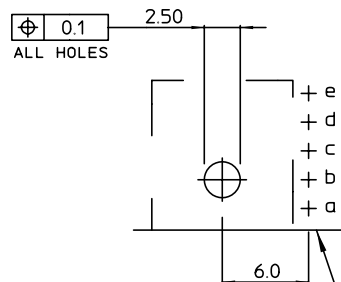

EDGE OF PC BOARD

Millipacs® HM

Power contacts

Description

Power pin and socket contacts for type L, M and N modules in accordance with DIN 41626 specifications.

Features and benefits

- High precision contacts to maximize durability performance.
- Beryllium copper locking spring for adequate locking and positioning of contacts into connector housing cavities.
- Wide variety of contact styles for crimp, dip and handsolder or press-fit connections.
- Contact plating types to meet various application requirements in the most cost effective way.
- Wide range of installation tools optimizing crimp connection performances.
- Contact removed from connector housing with simple extraction tool.



Construction

| | |
|------------------------|--------------------|
| Contact material | : copper alloy |
| Outer retention spring | : beryllium copper |
| Contact plating | : gold over nickel |
| Spring plating | : nickel |

Performance characteristics

| | |
|------------------------------|---|
| Operating temperature | : -55°C to +125°C |
| Operating current | : AWG 16 = 10 A AWG 12 = 20 A AWG 10 = 30 A |
| Insertion force | : 10 N max. per contact pair |
| Extraction force | : 1.6 N min. per contact pair |
| Contact retention in housing | : 50 N min. |

Millipacs® HM

Standard power contacts

Handsolder contacts

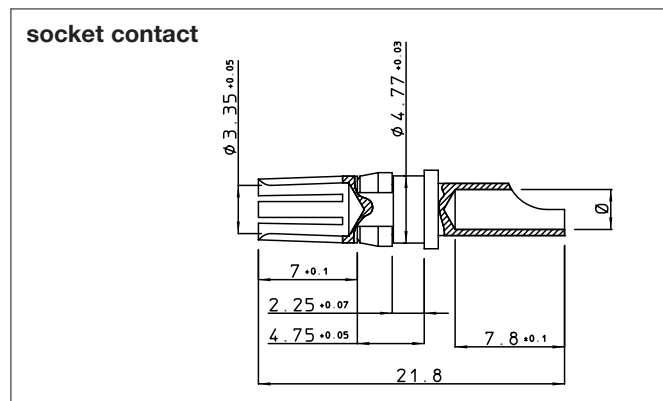
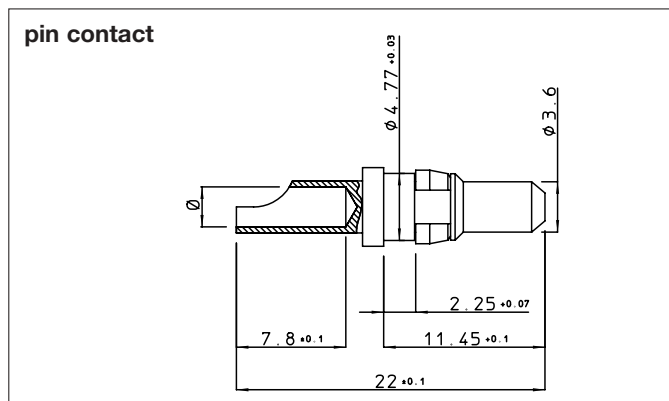

| Part number | Wire size | | Ø | Max. current | Extraction tool | |
|----------------|-----------|-----------------|-----|--------------|-----------------|----------------|
| | AWG | mm ² | | | Pin contact | Socket contact |
| R * 16PIE51ERP | 16 | 1.3 | 1.7 | 10 A | HM2Y197C | HM2Y197D |
| R * 12PIE51ERP | 12 | 4.0 | 2.8 | 20 A | HM2Y197C | HM2Y197D |
| R * 10PIE51ERP | 10 | 6.0 | 3.5 | 30 A | HM2Y197C | HM2Y197D |

(*) : M = pin contact
: C = socket contact

Standard power contacts

Crimp contacts

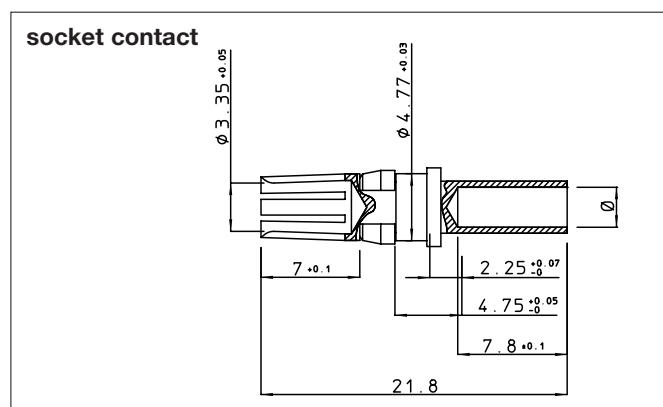
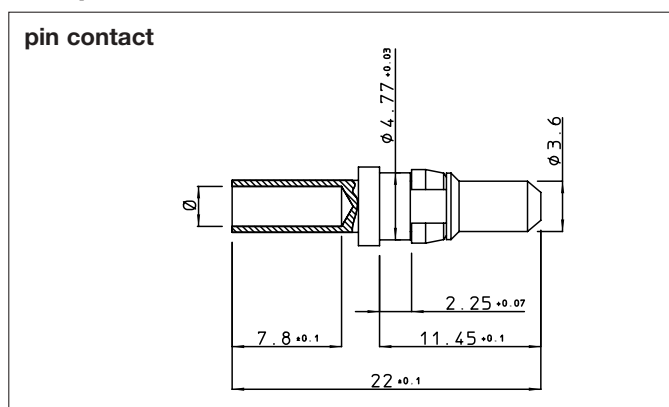

| Part number | Wire size | | Ø | Max. current | Strip length (mm) | Crimp tools | | | Extraction tool | |
|----------------|-----------|-----------------|-----|--------------|-------------------|-------------|--------|-----------------|-----------------|----------|
| | AWG | mm ² | | | | M10S1 | | M50F012 Adaptor | Pin | Socket |
| | | | | | | Dieset | Stop | | | |
| R * 16PIE57ERP | 16 | 1.3 | 1.7 | 10 A | 6.4 | S16 | SL19E1 | N° 1 | HM2Y197C | HM2Y197D |
| R * 12PIE57ERP | 12 | 4.0 | 2.8 | 20 A | 8.5 | S16E1 | SL19E1 | N° 1 | HM2Y197C | HM2Y197D |
| R * 10PIE57ERP | 10 | 6.0 | 3.5 | 30 A | 8.5 | S16E2 | SL19E1 | N° 3 | HM2Y197C | HM2Y197D |

(*) : M = pin contact
: C = socket contact

Millipacs® HM

Standard power contacts

Dipsolder contacts

pin contact

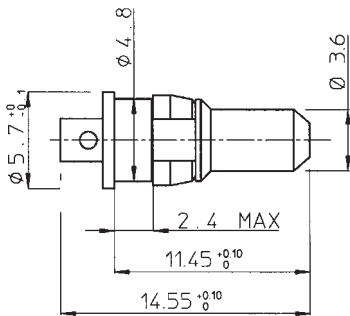

Part number : RM12PIE54ERP

Max. current : 10 A

socket contact

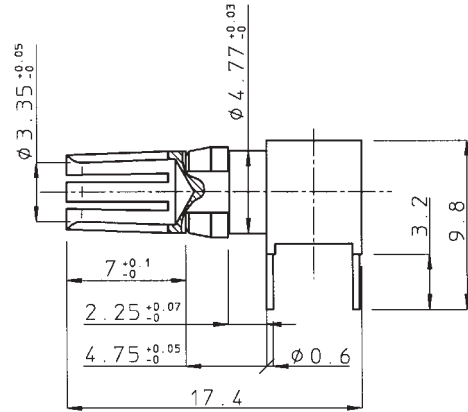

Part number : RC12PIE52ERP

Max. current : 10 A

Press-fit contacts

pin contact

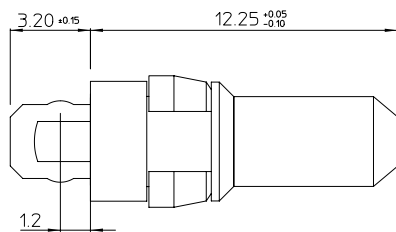

Part number : RM12PIE61ERP

Max. current : 40 A

socket contact

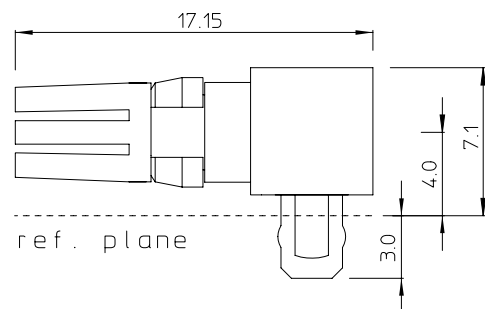

Part number : RC12PIE70ERP

Max. current : 40 A

Millipacs® HM

Advanced power contacts

Handsolder contacts

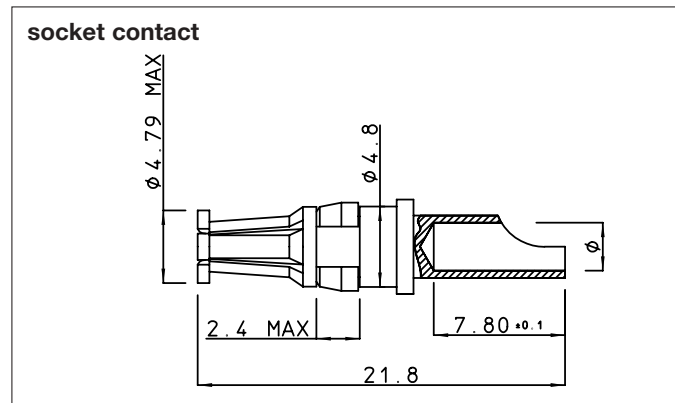
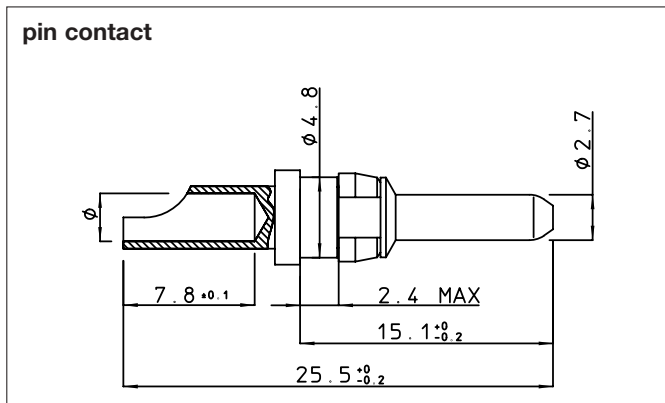

| Part number | Wire size AWG | mm ² | Ø | Max. current | Extraction tool | |
|----------------|------------------|-----------------|-----|-----------------|-----------------|----------------|
| | | | | | Pin contact | Socket contact |
| R * 16PIE91ERP | 16 | 1.3 | 1.7 | 10 A | HM2Y197C | HM2Y197D |
| R * 12PIE91ERP | 12 | 4.0 | 2.8 | 20 A | HM2Y197C | HM2Y197D |
| R * 10PIE91ERP | 10 | 6.0 | 3.5 | 30 A | HM2Y197C | HM2Y197D |

(*) : M = pin contact
: C = socket contact

Crimp contacts

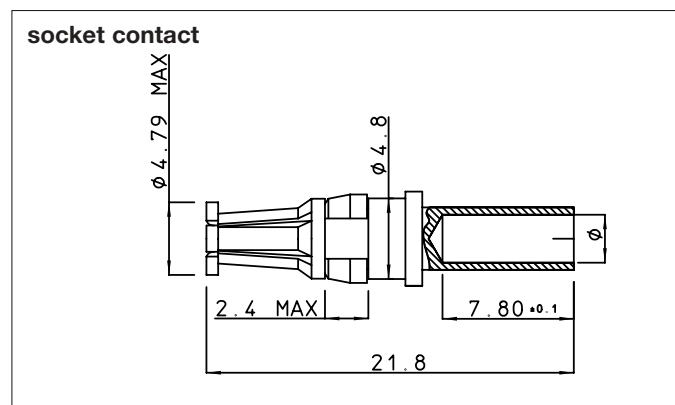
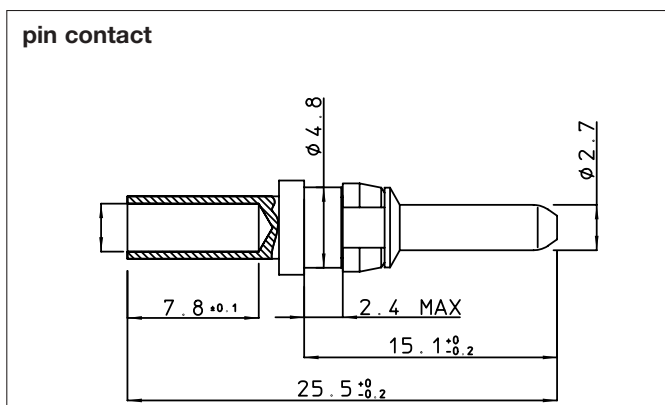

| Part number | Wire size | | Ø | Max. current | Strip length (mm) | Crimp tools | | | Extraction tool | |
|---------------|-----------|-----------------|-----|-----------------|----------------------|-------------|--------|--------------------|-----------------|----------|
| | AWG | mm ² | | | | M10S1 | | M50F012 Adaptor | Pin | Socket |
| | | | | | | Dieset | Stop | | | |
| R * 16PIE9ERP | 16 | 1.3 | 1.7 | 10 A | 6.4 | S16 | SL19E1 | N° 1 | HM2Y197C | HM2Y197D |
| R * 12PIE9ERP | 12 | 4.0 | 2.8 | 20 A | 8.5 | S16E1 | SL19E1 | N° 1 | HM2Y197C | HM2Y197D |
| R * 10PIE9ERP | 10 | 6.0 | 3.5 | 30 A | 8.5 | S16E2 | SL19E1 | N° 3 | HM2Y197C | HM2Y197D |

(*) : M = pin contact
: C = socket contact

Millipacs® HM

Advanced power contacts

Dipsolder contacts

pin contact

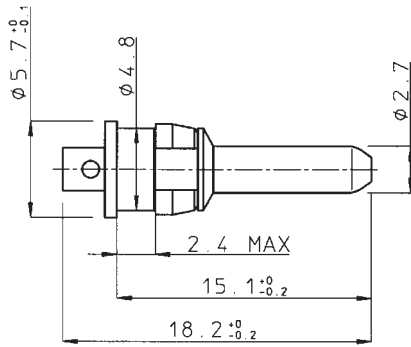

Part number : RM12PIE94ERP

Max. current : 10 A

socket contact

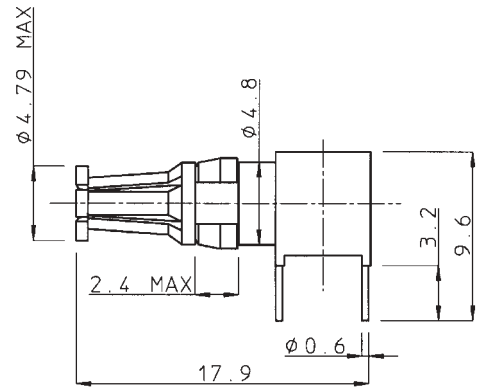

Part number : RC12PIE92ERP

Max. current : 10 A

Press-fit contacts

pin contact

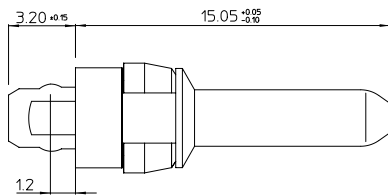

Part number : RM12PIE63ERP

Max. current : 40 A

socket contact

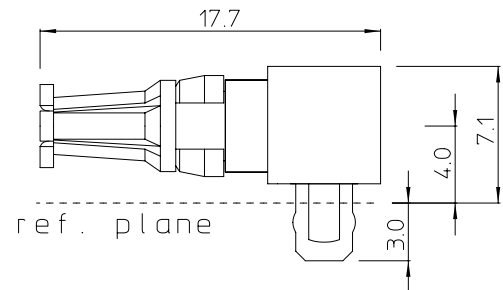

Part number : RC12PIE75ERP

Max. current : 40 A

Millipacs® HM

Coaxial contacts

Description

50 Ω coaxial contacts for type L, M and N modules in accordance with DIN 47297 specification.

Features and benefits

- The coaxial contacts are available with dip solder or crimp type straight and right angle termination.
- The assembly with coaxial cables consists of two operations involving soldering for the inner conductor with the inner contact and crimping for the outer components.
- The crimping operation is done with a handtool equipped with removable die sets according to the cable size.
- Contacts are front released and extracted by a simple handtool.



Construction

| | |
|-------------------------|--------------------------------|
| Outer and inner contact | : high conductive copper alloy |
| Spring | : beryllium copper |
| Contact plating | : gold over nickel |
| Spring plating | : nickel |
| Insulation | : PTFE |

Performance characteristics

| | |
|-----------------------|---|
| Characteristic | |
| impedance | : 50 Ω |
| Operating temperature | : -55°C to +125°C |
| Operating frequency | : maximum 30 GHz optimum 0-10 GHz |
| Reflection* | : 5% max. up to 1 GHz 7% max. up to 4 GHz 10% max. up to 10 GHz |

| | |
|--------------------|---|
| Peak voltage | : 750 V _{eff} |
| Operating voltage | : 250 V _{eff} |
| Contact resistance | : outer contact 3 mΩ max inner contact 10 mΩ max |

* Only for cable to cable connections

Assembly instructions

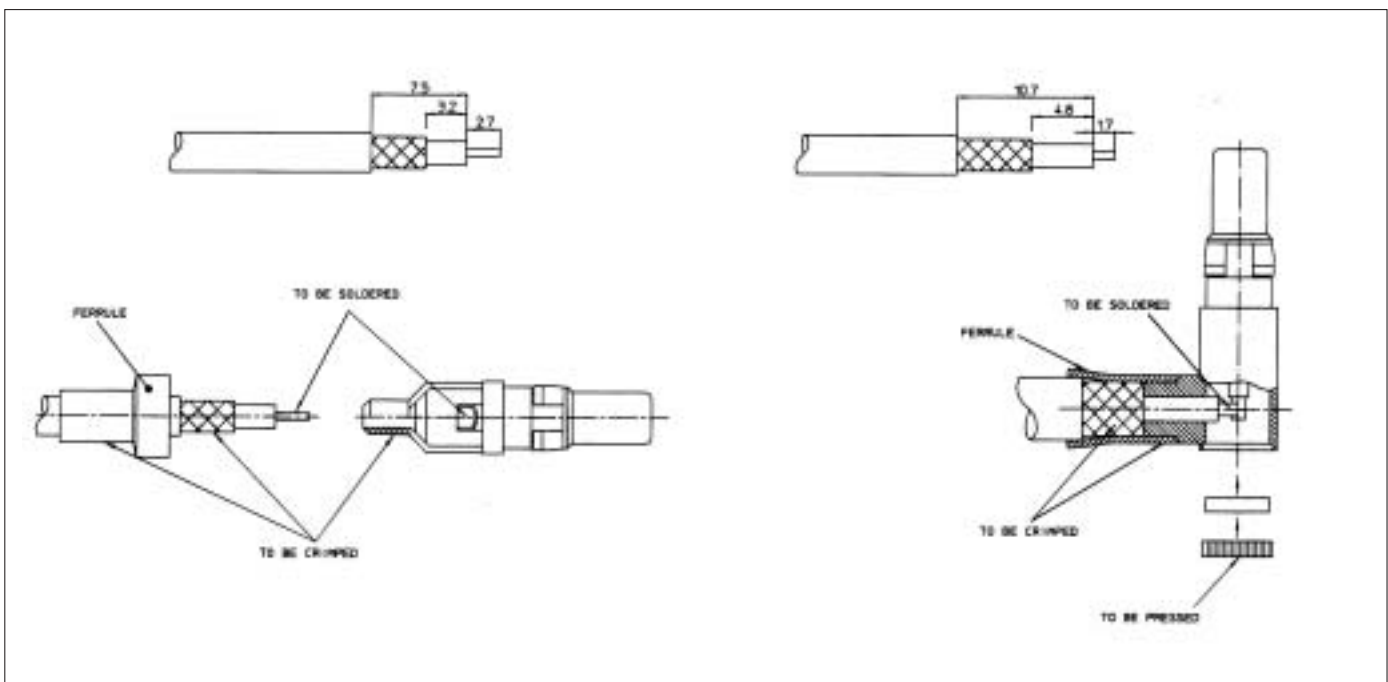

Millipacs® HM

Coaxial contacts

Straight termination

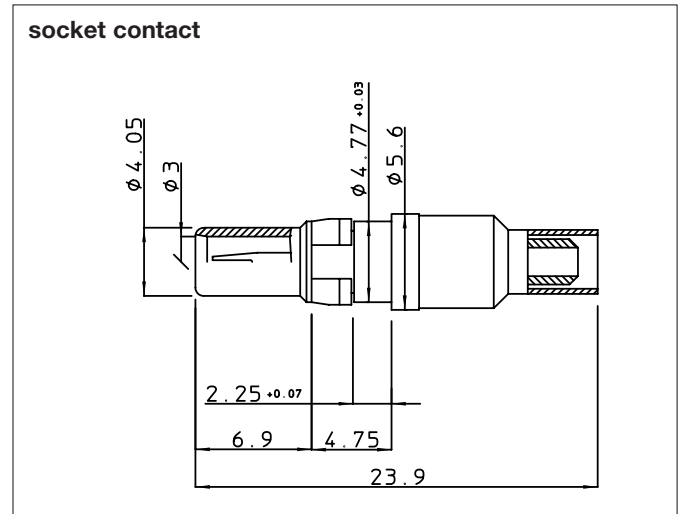
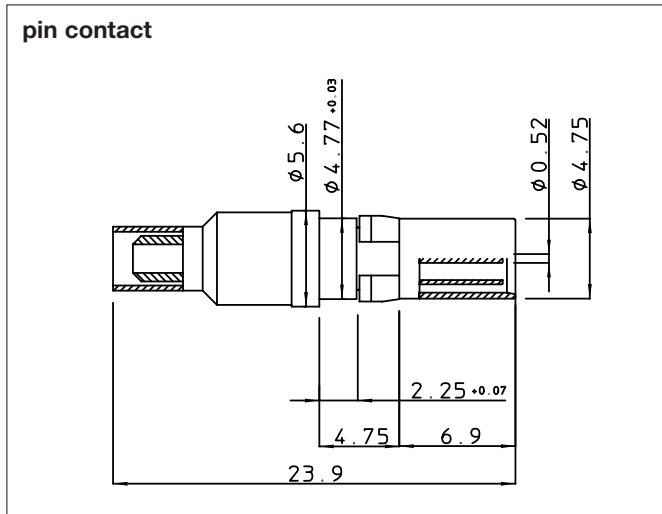

| Part number | Coaxial cables | Crimp tool | Die set | Extraction tool | |
|---|----------------|------------|----------|-----------------|----------|
| | | | | Pin | Socket |
| R * PIS01S02 E2R | RG174A/U | Y101COAXPI | Y101CX02 | HM2Y197D | HM2Y197C |
| | RG188A/U | | | | |
| | RG316/U | | | | |
| (*) : M = pin contact C = socket contact | | | | | |

Right angle termination

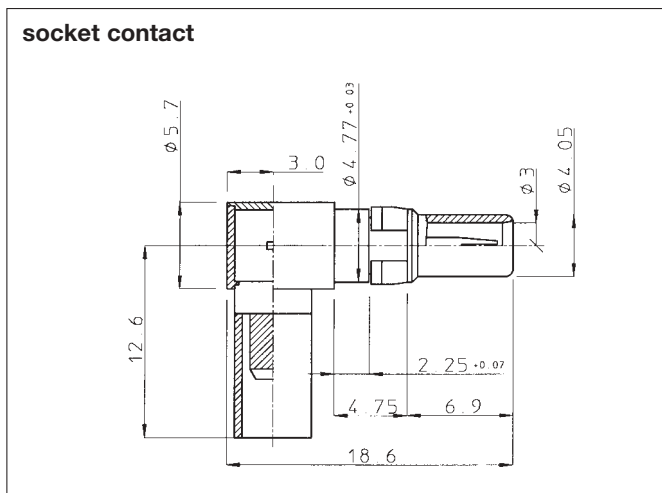

Dip solder termination

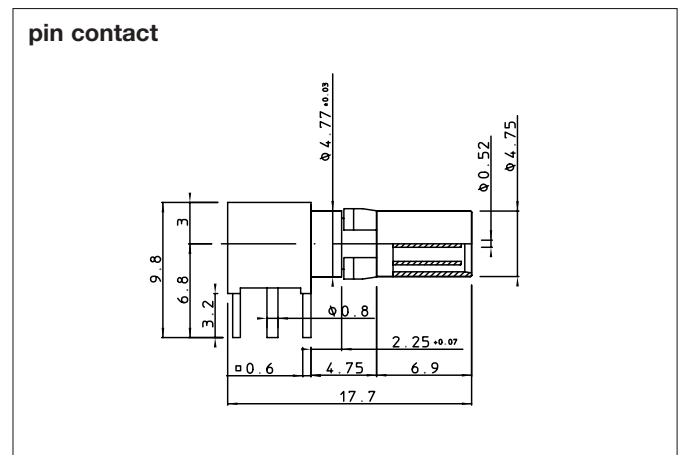

Part number : RMPIR01K00E2R

| Part number | Coaxial cables | Crimp tool | Die set | Extraction tool |
|----------------|----------------|------------|----------|-----------------|
| RCPIR01S02 E2R | RG174A/U | Y101COAXPI | Y101CX02 | HM2Y197C |
| | RG188A/U | | | |
| | RG316/U | | | |

Millipacs® HM

Coding devices

Description

Coding keys are used to prevent the incorrect insertion of cards into a system. They are clicked into the multifunctional area of male and female connectors with a special tool after the connectors have been pressed in. Each coding key has a different bright and pre-defined RAL color in order to make visual identification and differentiation easy.



| | | | | |
|--|--------------------------|--|------------------------|--|
| | 2003 pastel orange | | 5020 ocean blue | |
| | 5011 steel blue | | 5014 pigeon blue | |
| | 7015 slate grey | | 2000 yellow orange | |
| | 1021 cadmium yellow | | 6019 pastel green | |
| | 6011 reseda green | | 3027 raspberry red | |
| | 5007 brilliant blue | | 1015 light ivory | |
| | 4005 blue lilac | | 6001 emerald green | |
| | 1024 ocher yellow | | 4003 heather violet | |
| | 3018 strawberry red | | 2004 pure orange | |
| | 8011 nutbrown | | 8004 copper brown | |
| | 8000 greenbrown | | 6027 light green | |
| | 5002 ultramarine blue | | 3004 purple red | |
| | 7033 cement grey | | | |
| | | | | |

Millipacs® HM

Crimp tools for Power contacts

Description

A complete set of crimp tools is available for the power contacts. The crimping operation is done with a handtool equipped with removable die sets according to the cable size.

Crimp tool



M10S1

Crimp tool



M50F012

Crimp tools for Coax contacts

Description

A complete set of crimp tools is available for the coax contacts. The assembly with coaxial cables consists of two operations involving soldering for the inner conductor with the inner contact and crimping for the outer components.

The crimping operation is done with a handtool equipped with removable die set according to the cable size.

Crimp tool



Y101COAXPI

Die set

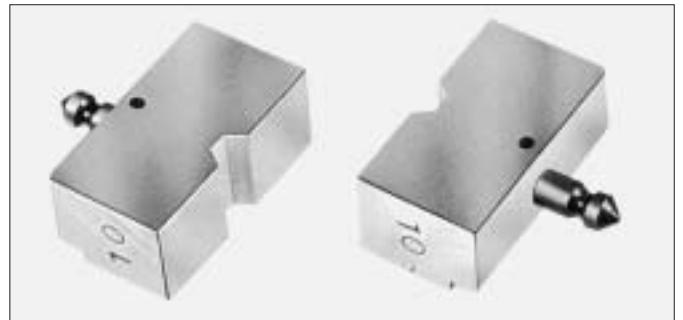

Y101CX02

Tooling : Coding key placing tool

Description

A plastic tool is available to support the coding keys during the fixation in the MP (Multi Purpose) centers.



How to order : HM2Y197E

Millipacs® HM

Pin repair tooling for removal of individual contacts

Description

For the repair of damaged contacts on a backplane, a set of handtools is available allowing each contact on the board to be removed and replaced individually.

Sets of individual loose contacts are available to re-insert.



How to order :

- HM2Y197A :** extraction tool for individual contacts
- HM2Y197B1 :** insertion tool for individual shielding contacts
- HM2Y197B2 :** insertion tool for individual signal contacts

Receptacle repair tooling for removal of complete modules

Description

Removal tool for damaged modules from a printed board. During this process the PC Board is not touched to avoid any cracks and stress in the layers and tracks.

Additional information and instruction sheets are available from FCI.

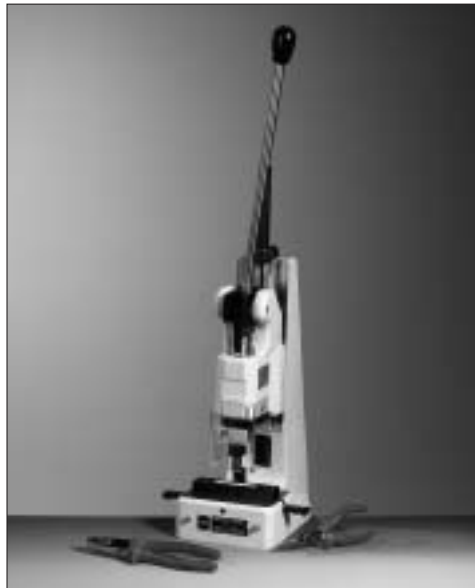

How to order :

- HM2Y236 :** repair tool for 5 and 8 row 50 mm female modules

Power & coax contacts repair tooling

Description

For the repair of damaged contacts out of hybrid modules, extraction tools for single contacts are available.

Each contact can be removed and replaced individually.



How to order :

- HM2Y197C :** repair tool for male connectors
- HM2Y197D :** repair tool for receptacle connectors

Millipacs® HM

Insertion machines : Impress® 500 series

Description

A complete range of machines is available to install all Millipacs® board connectors. Multifunctional X Y tables allow insertion of headers, shrouds or receptacle modules by quick changeover of the dedicated inserts and PCB supports.

All header and receptacle modules are inserted in a single operation with the same tooling. Insertion of modules with existing customer presses is also possible by adapting the top and bottom mounting bars according to customer requirements.

Features Impress® 500 M

- Insertion force : 25 kN (5625 lbf)
- Board size (1) : 270 mm (10.6")
throat depth
- Max. tool size : 150 mm (5.9")
- Press cycles per hour (2) : 300

Features Impress® 500 E

- Insertion force : 80 kN (18000 lbf)
- Board size (1) : 720 x 580 mm
(28.3"x 22.8")
- Max. tool size : 255 mm (10")
- Press cycles per hour (2) : 600



Part number : PAY 245 M



Part number : PAY 284 A2

IMPRESS® is a trademark of FCI or its affiliated companies.

(1) : Board size means maximum backplane size. For maximum daughterboard size, please refer to the specification.

(2) : These capacity figures are only an indication while the real capacity depends on the board and production parameters.

Millipacs® HM

IMPRESS® 500 E Compact

Description

The IMPRESS® 500 E Compact is a desktop version of the IMPRESS® 500 E. This machine is especially designed for quality minded users who do not need the extensive features of the standard IMPRESS® 500 E in terms of board size and maximum insertion force.

Features

- Insertion force : 50 kN (11250 lbf)
- Board size (1) : 600 mm (23.6")
between posts of the H-bridge
- Max. tool size : 255 mm (10")
- Press cycles per hour (2) : 500

IMPRESS® is a trademark of FCI or its affiliated companies.



Part number : PAY 326

CIP-12K

Description

The CIP-12K is a computer controlled, all electric closed loop servo driven press with two-hand, no tie down actuation. The CIP-12K is able to press connectors at any position along the surface of the press ram. Unique "Teach & Learn" operator friendly software (Patent Pending) ensures fast start-up and low training overhead.

Features

- Insertion force : 53 kN (12,000 lbf)
- Board size : 18" x 36" (457.1 mm x 914.4 mm)
- Press cycles per hour (2) : 600



(1) : Board size means maximum backplane size. For maximum daughterboard size, please refer to the specification.

(2) : These capacity figures are only an indication while the real capacity depends on the board and production parameters.

Millipacs® HM

Insertion machines IMPRESS® 1000 series

Description

This “state of the art” semi-automatic machine consists of a computer controlled X-Y table.

Connectors are placed manually into position on the boards and are then automatically, in sequence, pressed into the boards.

Features and benefits

- User-friendly programming thanks to an advanced man/machine interface in a graphical environment.
- Creating a new program consists in entering connector type, connector location and insertion depth on a host PC.
- The machine is operated by a satellite keyboard. This keyboard activates start, stop and single step cycles.
- Full insertion force monitoring and analysis.

Consult FCI for more information.



IMPRESS® 2000 series

Description

Fully robotic machine with automatic connector and backpanel feeding system for in-line assembly. Designed for high capacity serial productions.

Consult FCI for more information



IMPRESS® is a trademark of FCI or its affiliated companies.

Millipacs® HM

Insertion tooling :

Description

A complete set of tooling to install all different Millipacs® modules.

Features

- Same insertion units and anvils for non-shielded and shielded modules.
- No limitations in customized arrangements.
- Flat rock design for receptacle modules.

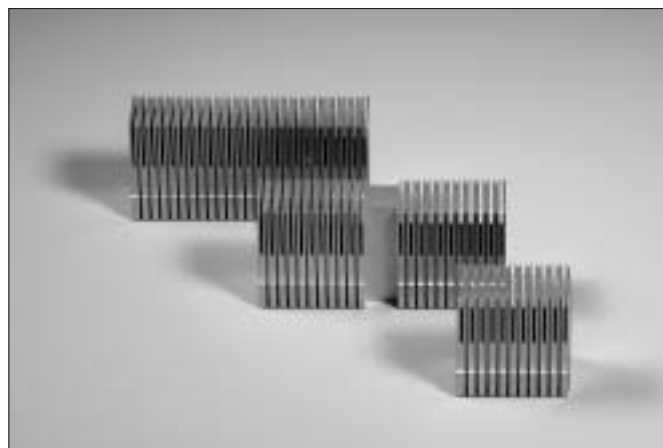

| (5 + 2) ROW | | IMPRESS 500M | | | IMPRESS 500E / 500E COMPACT | | | | |
|---------------------|--------|--------------|------------|------------|-----------------------------|------------|------------|------------|-----------|
| | | Anvil | Insert | Push blade | without LMT | | | with LMT** | |
| MODULES | | Anvil | Insert | Push blade | Anvil | Insert | Push blade | Anvil | LMT-blade |
| A | male | PAY245A3 | PAY245A20 | PAY245A8 | PAY307A1 | PAY245A20 | PAY308A2 | PAY307A1 | PAY308A16 |
| | female | PAY245A5 | -- * | PAY245A8 | PAY307A3 | -- | PAY308A49 | PAY307A3 | PAY308A49 |
| | shroud | HM2Y196A33 | -- | PAY245A103 | PAY307A89 | -- | PAY308A87 | PAY307A89 | PAY308A87 |
| B | male | PAY245A3 | PAY245A21 | PAY245A8 | PAY307A1 | PAY245A21 | PAY308A2 | PAY307A1 | PAY308A17 |
| | female | PAY245A5 | -- * | PAY245A8 | PAY307A3 | -- | PAY308A49 | PAY307A3 | PAY308A49 |
| | shroud | HM2Y196A33 | -- | PAY245A103 | PAY307A89 | -- | PAY308A87 | PAY307A89 | PAY308A87 |
| C / CR | male | PAY245A3 | PAY245A22 | PAY245A8 | PAY307A2 | PAY245A22 | PAY308A2 | PAY307A2 | PAY308A18 |
| | female | PAY245A5 | -- * | PAY245A8 | PAY307A3 | -- | PAY308A49 | PAY307A3 | PAY308A49 |
| | shroud | HM2Y196A33 | -- | PAY245A104 | PAY307A90 | -- | PAY308A88 | PAY307A90 | PAY308A88 |
| B (19 pos.) | male | PAY245A3 | HM2Y196A30 | PAY245A8 | PAY307A44 | HM2Y196A30 | PAY308A2 | PAY307A44 | PAY308A58 |
| | female | PAY245A5 | -- * | PAY245A8 | PAY307A44 | -- | PAY308A68 | PAY307A44 | PAY308A68 |
| | shroud | HM2Y196A33 | -- | PAY245A103 | PAY307A92 | -- | PAY308A90 | PAY307A92 | PAY308A90 |
| B (22 pos.) | male | PAY245A3 | HM2Y196A29 | PAY245A8 | PAY307A45 | HM2Y196A29 | PAY308A2 | PAY307A45 | PAY308A59 |
| | female | PAY245A5 | -- * | PAY245A8 | PAY307A45 | -- | PAY308A67 | PAY307A45 | PAY308A67 |
| | shroud | HM2Y196A33 | -- | PAY245A103 | PAY307A91 | -- | PAY308A89 | PAY307A91 | PAY308A89 |
| AB (25 pos.) | male | PAY245A3 | PAY245A73 | PAY245A8 | PAY307A1 | PAY245A73 | PAY308A2 | PAY307A1 | PAY308A69 |
| | female | PAY245A5 | -- * | PAY245A8 | PAY307A3 | -- | PAY308A49 | PAY307A3 | PAY308A49 |
| | shroud | HM2Y196A33 | -- | PAY245A103 | PAY307A89 | -- | PAY308A87 | PAY307A89 | PAY308A87 |
| AB (22 pos.) | male | PAY245A3 | PAY245A74 | PAY245A8 | PAY307A45 | PAY245A74 | PAY308A2 | PAY307A45 | PAY308A70 |
| | female | PAY245A5 | -- * | PAY245A8 | PAY307A45 | -- | PAY308A67 | PAY307A45 | PAY308A67 |
| | shroud | HM2Y196A33 | -- | PAY245A103 | PAY307A91 | -- | PAY308A89 | PAY307A91 | PAY308A89 |
| AB (19 pos.) | male | PAY245A3 | PAY245A75 | PAY245A8 | PAY307A44 | PAY245A75 | PAY308A2 | PAY307A44 | PAY308A71 |
| | female | PAY245A5 | -- * | PAY245A8 | PAY307A44 | -- | PAY308A68 | PAY307A44 | PAY308A68 |
| | shroud | HM2Y196A33 | -- | PAY245A103 | PAY307A92 | -- | PAY308A90 | PAY307A92 | PAY308A90 |
| M (pre-ass.) | male | PAY245A32 | PAY245A29 | PAY245A8 | PAY307A68 | PAY245A29 | PAY308A2 | on request | |
| | female | PAY245A32 | -- | PAY245A8 | PAY307A68 | -- | PAY308A49 | on request | |
| L (pre-ass.) | male | PAY245A33 | PAY245A30 | PAY245A8 | PAY307A69 | PAY245A30 | PAY308A2 | on request | |
| | female | PAY245A33 | -- | PAY245A8 | PAY307A69 | -- | PAY308A49 | on request | |
| N (pre-ass.) | male | PAY245A34 | PAY245A31 | PAY245A8 | PAY307A70 | PAY245A31 | PAY308A2 | on request | |
| | female | PAY245A34 | -- | PAY245A8 | PAY307A70 | -- | PAY308A49 | on request | |
| M | shroud | HM2Y196A33 | -- | PAY245A103 | PAY307A89 | -- | PAY308A87 | PAY307A89 | PAY308A87 |
| L | shroud | HM2Y196A33 | -- | PAY245A103 | PAY307A89 | -- | PAY308A87 | PAY307A89 | PAY308A87 |
| N | shroud | HM2Y196A33 | -- | PAY245A104 | PAY307A90 | -- | PAY308A88 | PAY307A90 | PAY308A88 |

(*) : for easy positioning of the connector, use PAY245A6 (zero positioning block)

(**) : not available on IMPRESS 500E COMPACT

Tools for IMPRESS1000 and IMPRESS2000 on request.

Millipacs® HM

| (8 + 2) ROW | | IMPRESS 500M | | | IMPRESS 500E / 500E COMPACT | | | | |
|---------------------|--------|--------------|------------|------------|-----------------------------|------------|------------|------------|------------|
| | | | | | without LMT | | | with LMT** | |
| | | Anvil | Insert | Push blade | Anvil | Insert | Push blade | Anvil | LMT-blade |
| MODULES | | | | | | | | | |
| D | male | PAY245A90 | PAY245A13 | PAY245A16 | PAY307A40 | PAY245A13 | PAY308A72 | PAY307A40 | PAY308A74 |
| | female | PAY245A91 | -- * | PAY245A16 | PAY307A71 | -- | PAY308A30 | PAY307A71 | PAY308A30 |
| | shroud | PAY245A100 | -- | PAY245A101 | PAY307A87 | -- | PAY308A85 | PAY307A87 | PAY308A85 |
| E | male | PAY245A90 | PAY245A12 | PAY245A16 | PAY307A40 | PAY245A12 | PAY308A72 | PAY307A40 | PAY308A75 |
| | female | PAY245A91 | -- * | PAY245A16 | PAY307A71 | -- | PAY308A30 | PAY307A71 | PAY308A30 |
| | shroud | PAY245A100 | -- | PAY245A101 | PAY307A87 | -- | PAY308A85 | PAY307A87 | PAY308A85 |
| F / FR | male | PAY245A90 | PAY245A14 | PAY245A16 | PAY307A41 | PAY245A14 | PAY308A72 | PAY307A41 | PAY308A76 |
| | female | PAY245A91 | -- * | PAY245A16 | PAY307A74 | -- | PAY308A73 | PAY307A74 | PAY308A73 |
| | shroud | PAY245A100 | -- | PAY245A102 | PAY307A88 | -- | PAY308A86 | PAY307A88 | PAY308A86 |
| DE (25 pos.) | male | PAY245A90 | PAY245A106 | PAY245A16 | PAY307A40 | PAY245A106 | PAY308A72 | PAY307A40 | PAY308A103 |
| | female | PAY245A91 | -- * | PAY245A16 | PAY307A71 | -- | PAY308A30 | PAY307A71 | PAY308A30 |
| | shroud | PAY245A100 | -- | PAY245A101 | PAY307A87 | -- | PAY308A85 | PAY307A87 | PAY308A85 |
| DE (22 pos.) | male | PAY245A110 | PAY245A107 | PAY245A16 | PAY307A43 | PAY245A107 | PAY308A72 | PAY307A43 | PAY308A104 |
| | female | PAY245A91 | -- * | PAY245A16 | PAY307A76 | -- | PAY308A106 | PAY307A76 | PAY308A106 |
| | shroud | PAY245A100 | -- | PAY245A101 | PAY307A97 | -- | PAY308A108 | PAY307A97 | PAY308A108 |
| DE (19 pos.) | male | PAY245A109 | PAY245A108 | PAY245A16 | PAY307A42 | PAY245A108 | PAY308A72 | PAY307A42 | PAY308A105 |
| | female | PAY245A91 | -- * | PAY245A16 | PAY307A75 | -- | PAY308A107 | PAY307A75 | PAY308A107 |
| | shroud | PAY245A100 | -- | PAY245A101 | PAY307A96 | -- | PAY308A109 | PAY307A96 | PAY308A106 |

(*) : for easy positioning of the connector, use PAY245A6 (zero positioning block)

(**) : not available on IMPRESS 500E COMPACT

Tools for IMPRESS1000 and IMPRESS2000 on request.

IDC termination tooling

Description

A full range of termination tooling is available for low, middle and high volume production.

Contact FCI for advice & support on your specific requirements.



| Part nr | repair tooling | Handtooling | Cable terminator | Set for cable terminator | Handtool for crimping | Die set for handpress | Handpress |
|----------------|----------------|-------------|------------------|--------------------------|-----------------------|-----------------------|-----------|
| HM2C01D0C010N9 | BPY75D17 | BPY13817 | BPY6736PC1UK | BPY6736A5 | | | |
| HM2C01D2C010N9 | | | | | | | |
| HM2C06D0C010N9 | | | | | | | |
| HM2C06D2C010N9 | | | | | | | |
| HM2C09D0C011N9 | BPY75D25 | BPY13830 | BPY6736PC1UK | BPY6736A6 | HM2Y289A1 | HM2Y312A1 | HM2Y291 |
| HM2C09D2C011N9 | | | | | HM2Y289A1 | HM2Y312A1 | HM2Y291 |
| HM2C10D0C011N9 | | | | | HM2Y289A2 | HM2Y312A2 | HM2Y291 |
| HM2C10D2C011N9 | | | | | HM2Y289A2 | HM2Y312A2 | HM2Y291 |
| HM2C11D0C011N9 | | | | | HM2Y289A3 | HM2Y312A3 | HM2Y291 |
| HM2C11D2C011N9 | | | | | HM2Y289A3 | HM2Y312A3 | HM2Y291 |
| HM2C12D0C011N9 | | | | | HM2Y289A4 | HM2Y312A4 | HM2Y291 |
| HM2C12D2C011N9 | | | | | HM2Y289A4 | HM2Y312A4 | HM2Y291 |

Millipacs® HM

Plated through hole definitions

PLATED THROUGH HOLE SIGNAL CONTACT

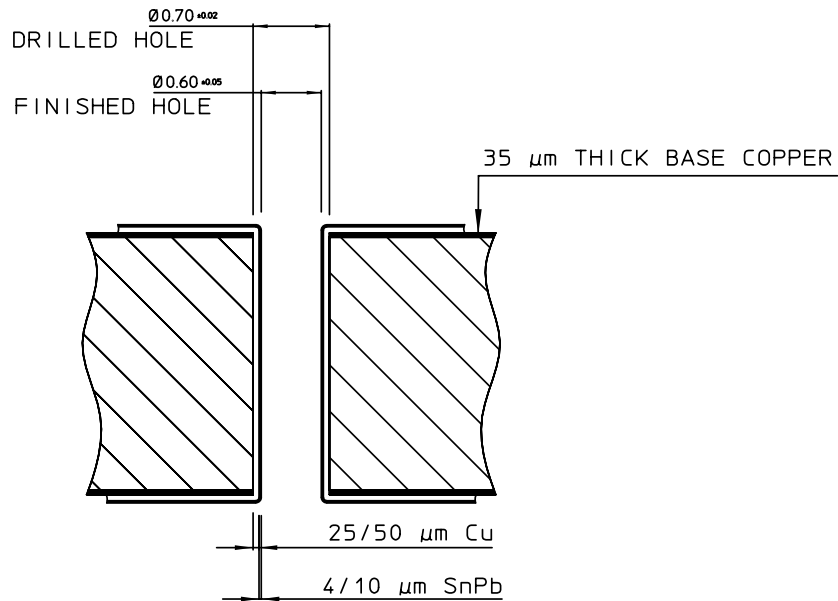

PLATED THROUGH HOLE POWER CONTACT

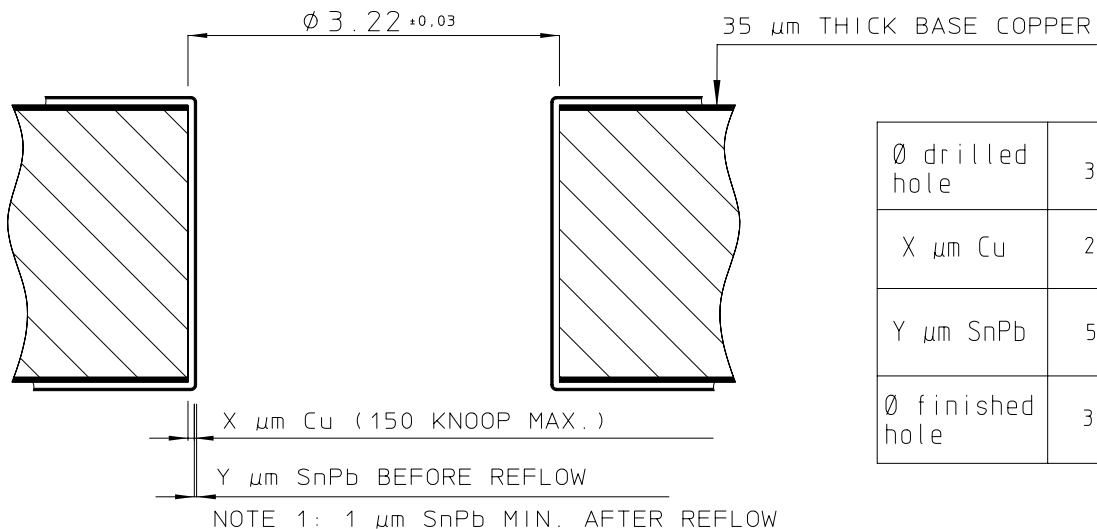

| | |
|-----------------------------|----------------------|
| \varnothing drilled hole | 3.19/3.25 |
| X μm Cu | 25 μm min |
| Y μm SnPb | 5 μm min. |
| \varnothing finished hole | 3.02/3.20 |

Millipacs® HM

Backplane layout

BACKPLANE LAY-OUT TYPE A, B, C AND CR

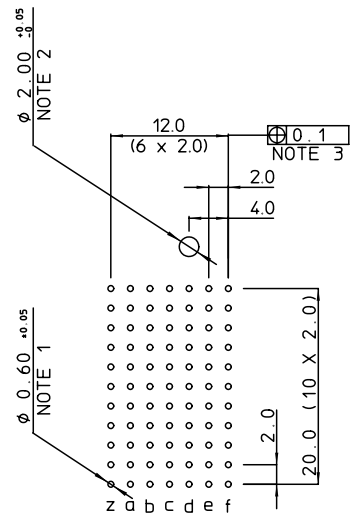

STYLE CR

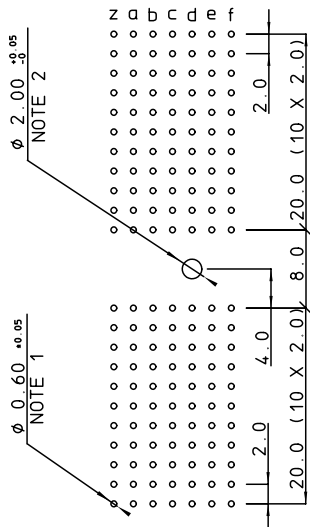

STYLE A

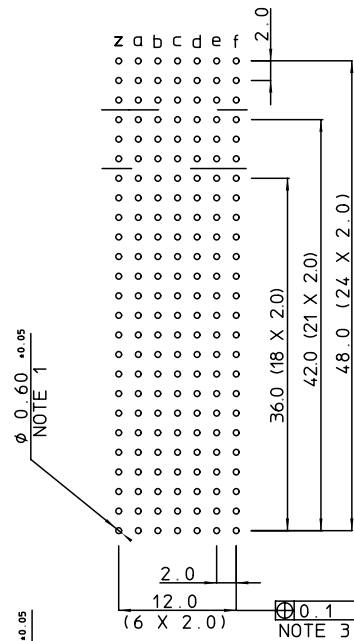

STYLE B, B22, B19

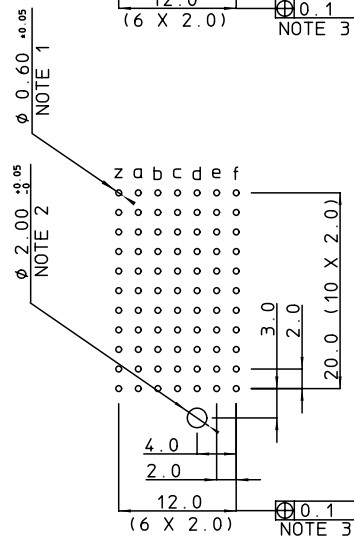

STYLE C

NOTES

1. PLATED-THROUGH HOLES
SEE DETAIL PLATED-THROUGH HOLE
2. HOLES FOR LOCATION PEGS
(NOT PLATED-THROUGH HOLES)
3. ALL HOLES

Millipacs® HM

PCB layout

PCB LAY-OUT FOR TYPE A, B, C AND CR

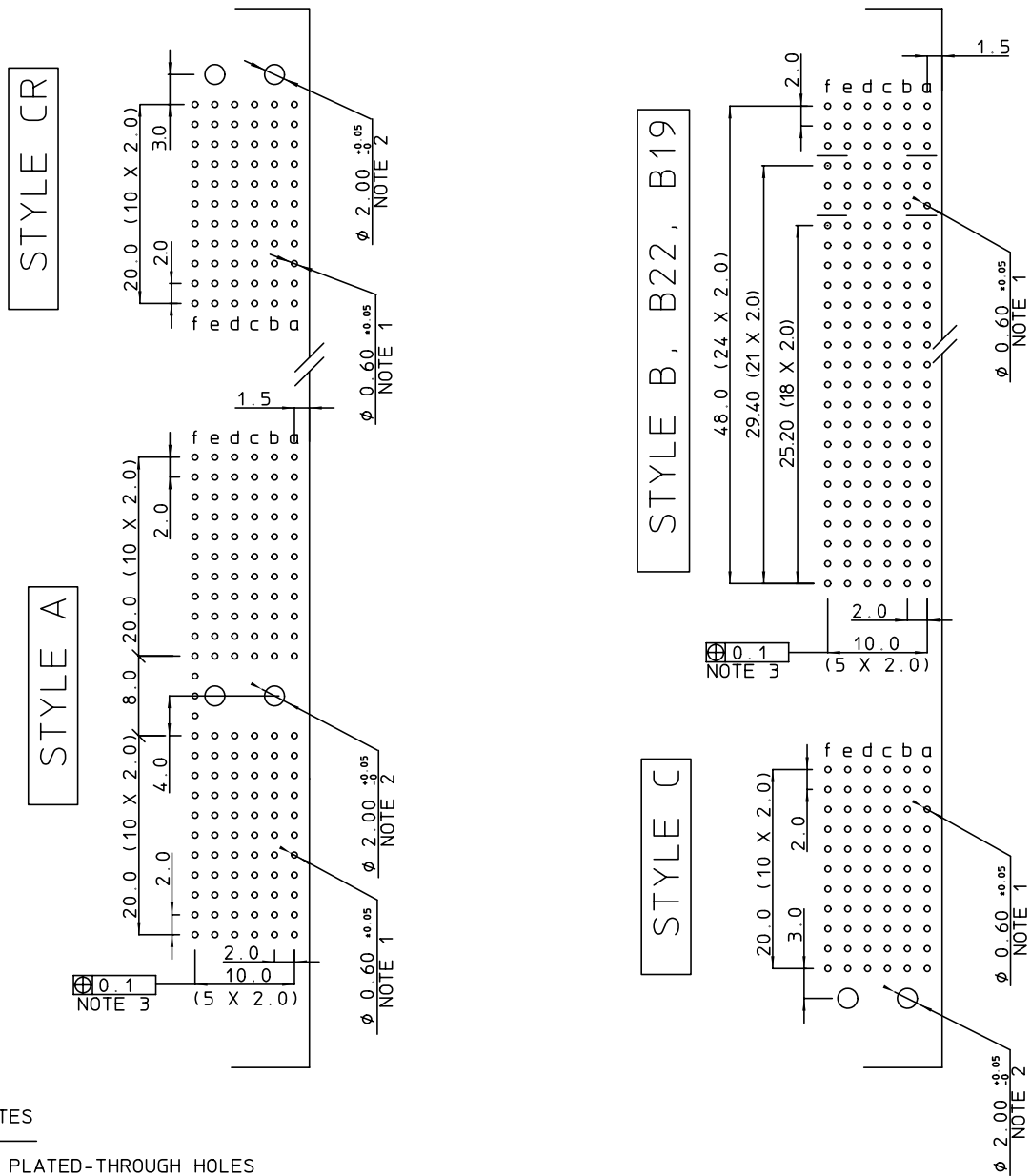

NOTES

1. PLATED-THROUGH HOLES
SEE DETAIL PLATED-THROUGH HOLE
2. HOLES FOR LOCATION PEGS
(NOT PLATED-THROUGH)
3. ALL HOLES

Millipacs® HM

Backplane and PCB layout

BACKPLANE LAY-OUT TYPE L, M AND N

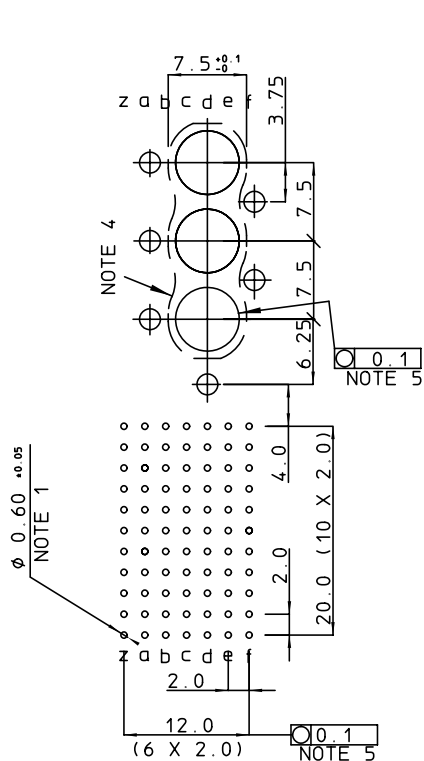

STYLE M

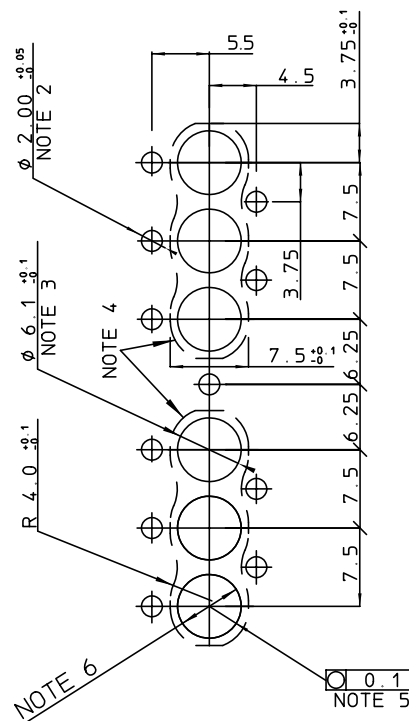

STYLE L

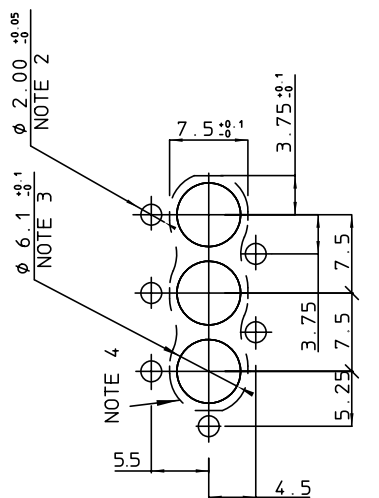

STYLE N

NOTES

1. PLATED-THROUGH HOLES
SEE DETAIL FOR PLATED-THROUGH HOLE
2. HOLES FOR LOCATION PEGS
(NOT PLATED-THROUGH)
3. HOLES FOR SPECIAL CONTACTS
4. HOLE PATTERN FOR FIBRE OPTIC CONTACTS
5. ALL HOLES

Millipacs® HM

Backplane and PCB layout

PCB LAY-OUT FOR TYPE L, M AND N

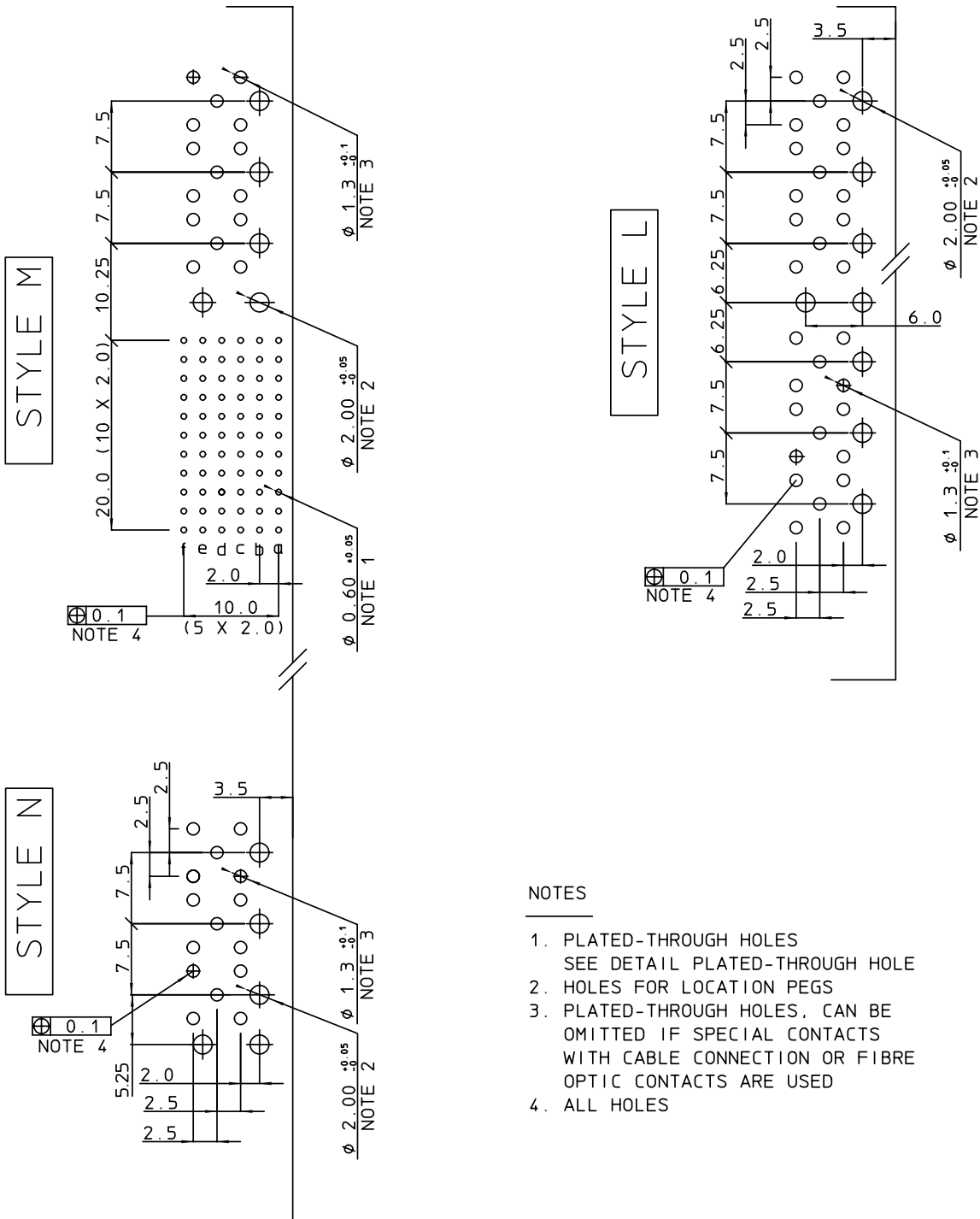

NOTES

1. PLATED-THROUGH HOLES
SEE DETAIL PLATED-THROUGH HOLE
2. HOLES FOR LOCATION PEGS
3. PLATED-THROUGH HOLES, CAN BE OMITTED IF SPECIAL CONTACTS WITH CABLE CONNECTION OR FIBRE OPTIC CONTACTS ARE USED
4. ALL HOLES

Millipacs® HM

Backplane and PCB layout

PCB LAY-OUT FOR TYPE D, E, F AND FR

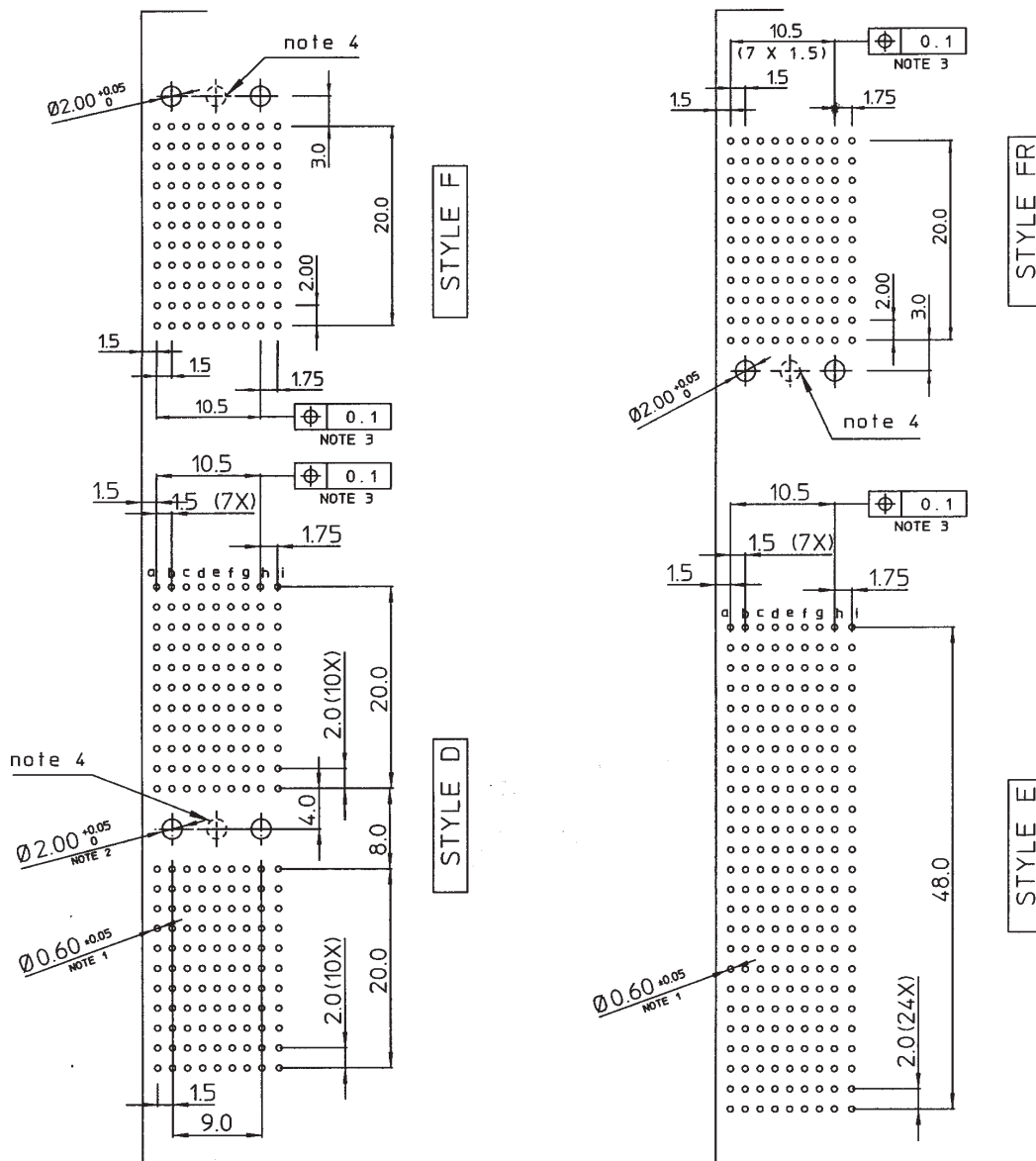

NOTES

1. PLATED-THROUGH HOLES
SEE DETAIL PLATED-THROUGH HOLE
2. HOLES FOR LOCATION PEGS
3. PLATED-THROUGH HOLES, CAN BE OMITTED IF SPECIAL CONTACTS WITH CABLE CONNECTION OR FIBRE OPTIC CONTACTS ARE USED
4. ALL HOLES

Millipacs® HM

Backplane and PCB layout

BACKPLANE LAY-OUT TYPE D, E, F AND FR

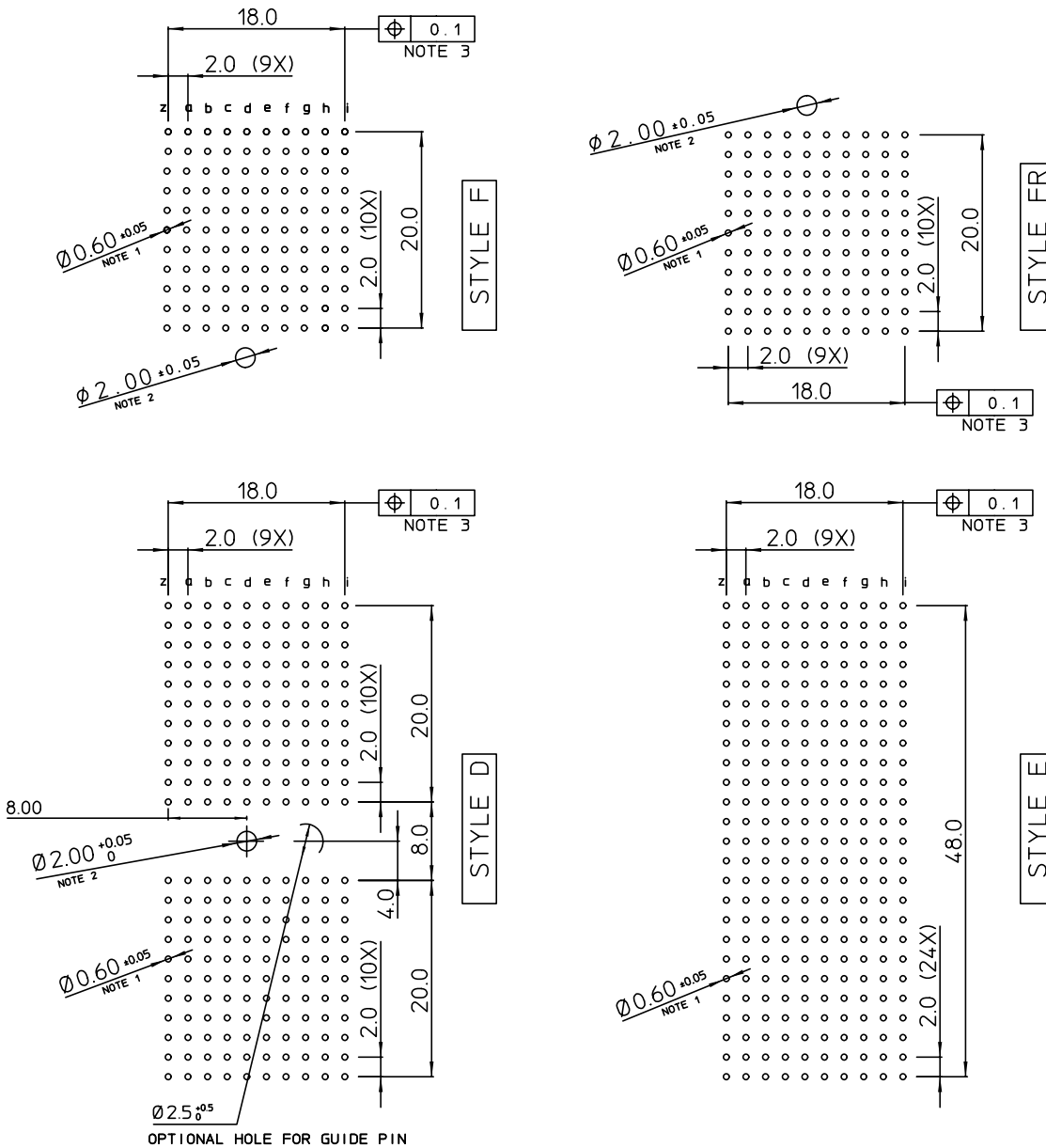

NOTES

1. PLATED-THROUGH HOLES
SEE DETAIL PLATED-THROUGH HOLE
2. HOLES FOR LOCATION PEGS
(NOT PLATED-THROUGH HOLES)
3. ALL HOLES

Millipacs® HM

Part number list

| description | partnumber | page | description | partnumber | page |
|----------------------|----------------|------|----------------------------------|----------------|------|
| type A header | HM2P07PD5110N9 | 13 | type M receptacle | HM2R05PA5108N9 | 40 |
| type A header | HM2P07PD5111N9 | 13 | type M receptacle | HM2R50PA5100N9 | 40 |
| type A header | HM2P07PK5110GF | 13 | type M receptacle | HM2R50PA5108N9 | 40 |
| type A header | HM2P07PK5111GF | 13 | type N hybrid body | HM2R06P1 | 41 |
| type B header | HM2P08PD5110N9 | 14 | type D receptacle | HM2R87PA8100N9 | 42 |
| type B header | HM2P08PD5111N9 | 14 | type D receptacle | HM2R87PA8108N9 | 42 |
| type B header | HM2P08PK5110GF | 14 | type D receptacle | HM2R81PA8100N9 | 42 |
| type B header | HM2P08PK5111GF | 14 | type D receptacle | HM2R81PA8108N9 | 42 |
| type B22 header | HM2P70PD5110N9 | 15 | type E receptacle | HM2R88PA8100N9 | 43 |
| type B22 header | HM2P70PD5111N9 | 15 | type E receptacle | HM2R88PA8108N9 | 43 |
| type B22 header | HM2P70PK5110GF | 15 | type DE receptacle | HM2R95PA8100N9 | 44 |
| type B22 header | HM2P70PK5111GF | 15 | type DE receptacle | HM2R95PA8108N9 | 44 |
| type B19 header | HM2P71PD5110N9 | 16 | type F receptacle | HM2R89PA8100N9 | 45 |
| type B19 header | HM2P71PD5111N9 | 16 | type F receptacle | HM2R89PA8108N9 | 45 |
| type B19 header | HM2P71PK5110GF | 16 | type F receptacle | HM2R83PA8100N9 | 45 |
| type B19 header | HM2P71PK5111GF | 16 | type F receptacle | HM2R83PA8108N9 | 45 |
| type AB header | HM2P65PD5110N9 | 17 | type FR receptacle | HM2R82PA8100N9 | 46 |
| type AB header | HM2P65PD5111N9 | 17 | type FR receptacle | HM2R82PA8108N9 | 46 |
| type AB header | HM2P65PK5110GF | 17 | type FR receptacle | HM2R90PA8100N9 | 46 |
| type AB header | HM2P65PK5111GF | 17 | type FR receptacle | HM2R90PA8108N9 | 46 |
| type AB22 header | HM2P66PD5110N9 | 18 | type A lower shield | HM2LS22A | 47 |
| type AB22 header | HM2P66PD5111N9 | 18 | type B lower shield | HM2LS25A | 47 |
| type AB22 header | HM2P66PK5110GF | 18 | type B22 lower shield | HM2LS70A | 47 |
| type AB22 header | HM2P66PK5111GF | 18 | type B19 lower shield | HM2LS71A | 47 |
| type AB19 header | HM2P67PD5110N9 | 19 | type AB lower shield | HM2LS22A | 47 |
| type AB19 header | HM2P67PD5111N9 | 19 | type AB22 lower shield | HM2LS66A | 47 |
| type AB19 header | HM2P67PK5110GF | 19 | type AB19 lower shield | HM2LS67A | 47 |
| type AB19 header | HM2P67PK5111GF | 19 | type C lower shield | HM2LS11A | 47 |
| type C header | HM2P09PD5110N9 | 20 | type CR lower shield | HM2LS11A | 47 |
| type C header | HM2P09PD5111N9 | 20 | type M lower shield | HM2LS11A | 47 |
| type C header | HM2P09PK5110GF | 20 | type D lower shield | HM2LS22A8 | 47 |
| type C header | HM2P09PK5111GF | 20 | type E lower shield | HM2LS25A8 | 47 |
| type CR header | HM2P80PD5110N9 | 21 | type DE lower shield | HM2LS22A8 | 47 |
| type CR header | HM2P80PD5111N9 | 21 | type F lower shield | HM2LS11A8 | 47 |
| type CR header | HM2P80PK5110GF | 21 | type FR lower shield | HM2LS11A8 | 47 |
| type CR header | HM2P80PK5111GF | 21 | type A female straight | HM2S10PE5100N9 | 48 |
| type L hybrid body | HM2P10P1 | 22 | type A female straight | HM2S10PE5101N9 | 48 |
| type M header | HM2P11PD5110N9 | 23 | type A female straight | HM2S10PK5100GF | 48 |
| type M header | HM2P11PD5111N9 | 23 | type A female straight | HM2S10PK5101GF | 48 |
| type M header | HM2P11PK5110GF | 23 | type B female straight | HM2S02PE5100N9 | 49 |
| type M header | HM2P11PK5111GF | 23 | type B female straight | HM2S02PE5101N9 | 49 |
| type N hybrid body | HM2P12P1 | 24 | type B female straight | HM2S02PK5100GF | 49 |
| type D header | HM2P87PD8110N9 | 25 | type B female straight | HM2S02PK5101GF | 49 |
| type D header | HM2P87PD8111N9 | 25 | type B22 female straight | HM2S70PE5100N9 | 50 |
| type D header | HM2P87PK8110GF | 25 | type B22 female straight | HM2S70PE5101N9 | 50 |
| type D header | HM2P87PK8111GF | 25 | type B22 female straight | HM2S70PK5100GF | 50 |
| type E header | HM2P88PD8110N9 | 26 | type B22 female straight | HM2S70PK5101GF | 50 |
| type E header | HM2P88PD8111N9 | 26 | type B19 female straight | HM2S71PE5100N9 | 51 |
| type E header | HM2P88PK8110GF | 26 | type B19 female straight | HM2S71PE5101N9 | 51 |
| type E header | HM2P88PK8111GF | 26 | type B19 female straight | HM2S71PK5100GF | 51 |
| type DE header | HM2P95PD8110N9 | 27 | type B19 female straight | HM2S71PK5101GF | 51 |
| type DE header | HM2P95PD8111N9 | 27 | type C female straight | HM2S30PE5100N9 | 52 |
| type DE header | HM2P95PK8110GF | 27 | type C female straight | HM2S30PE5101N9 | 52 |
| type DE header | HM2P95PK8111GF | 27 | type C female straight | HM2S30PK5100GF | 52 |
| type F header | HM2P89PD8110N9 | 28 | type C female straight | HM2S30PK5101GF | 52 |
| type F header | HM2P89PD8111N9 | 28 | type A male right angle | HM2J07PE5110N9 | 53 |
| type F header | HM2P89PK8110GF | 28 | type A male right angle | HM2J07PE5118N9 | 53 |
| type F header | HM2P89PK8111GF | 28 | type B male right angle | HM2J08PE5110N9 | 54 |
| type FR header | HM2P82PD8110N9 | 29 | type B male right angle | HM2J08PE5118N9 | 54 |
| type FR header | HM2P82PD8111N9 | 29 | type B22 male right angle | HM2J70PE5110N9 | 55 |
| type FR header | HM2P82PK8110GF | 29 | type B22 male right angle | HM2J70PE5118N9 | 55 |
| type FR header | HM2P82PK8111GF | 29 | type B19 male right angle | HM2J71PE5110N9 | 56 |
| type A receptacle | HM2R01PA5100N9 | 30 | type B19 male right angle | HM2J71PE5118N9 | 56 |
| type A receptacle | HM2R01PA5108N9 | 30 | type CA male right angle | HM2J09PE5110N9 | 57 |
| type A receptacle | HM2R10PA5100N9 | 30 | type CA male right angle | HM2J09PE5118N9 | 57 |
| type A receptacle | HM2R10PA5108N9 | 30 | 10 pos. LF non shielded cable c. | HM2C06D0C010N9 | 58 |
| type B receptacle | HM2R02PA5100N9 | 31 | 10 pos. LF non shielded cable c. | HM2C06D2C010N9 | 58 |
| type B receptacle | HM2R02PA5108N9 | 31 | 20 pos. LF non shielded cable c. | HM2C01D0C010N9 | 58 |
| type B22 receptacle | HM2R70PA5100N9 | 32 | 20 pos. LF non shielded cable c. | HM2C01D2C010N9 | 58 |
| type B22 receptacle | HM2R70PA5108N9 | 32 | 10 pos. LF shielded cable c. | HM2C09D0C011N9 | 59 |
| type B19 receptacle | HM2R71PA5100N9 | 33 | 10 pos. LF shielded cable c. | HM2C09D2C011N9 | 59 |
| type B19 receptacle | HM2R71PA5108N9 | 33 | 20 pos. LF shielded cable c. | HM2C10D0C011N9 | 59 |
| type AB receptacle | HM2R65PA5108N9 | 34 | 20 pos. LF shielded cable c. | HM2C10D2C011N9 | 59 |
| type AB receptacle | HM2R65PA5108N9 | 34 | 30 pos. LF shielded cable c. | HM2C11D0C011N9 | 59 |
| type AB22 receptacle | HM2R66PA5100N9 | 35 | 30 pos. LF shielded cable c. | HM2C11D2C011N9 | 59 |
| type AB22 receptacle | HM2R66PA5108N9 | 35 | 40 pos. LF shielded cable c. | HM2C12D0C011N9 | 59 |
| type AB19 receptacle | HM2R67PA5100N9 | 36 | 40 pos. LF shielded cable c. | HM2C12D2C011N9 | 59 |
| type AB19 receptacle | HM2R67PA5108N9 | 36 | 5 row board to board shrouds | HM2H**P1 | 60 |
| type C receptacle | HM2R03PA5100N9 | 37 | cable to board shrouds | HM2H**P1 | 62 |
| type C receptacle | HM2R03PA5108N9 | 37 | cable locking key | HM2LK1 | 62 |
| type C receptacle | HM2R30PA5100N9 | 37 | 8 row board to board shrouds | HM2H**P1 | 63 |
| type C receptacle | HM2R30PA5108N9 | 37 | male ESD, guiding hardware | HM2G01 | 64 |
| type CR receptacle | HM2R20PA5100N9 | 38 | female ESD, guiding hardware | HM2G02 | 64 |
| type CR receptacle | HM2R20PA5108N9 | 38 | power contacts | | 65 |
| type CR receptacle | HM2R21PA5100N9 | 38 | coax contacts | | 70 |
| type CR receptacle | HM2R21PA5108N9 | 38 | male coding devices | HM2DK****P | 72 |
| type L hybrid body | HM2R04P1 | 39 | female coding devices | HM2DK****R | 72 |
| type M receptacle | HM2R05PA5100N9 | 40 | tooling | | 73 |

U.S.A. Tel.: (800) 237-2374; 717-938-7200
Canada Tel.: 905-826-9810
Europe Tel.: 31-73-6206-911
Asia/Pacific Tel.: 65-549-6666

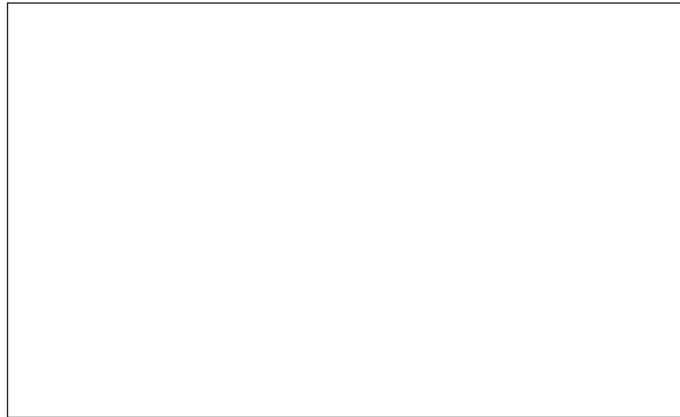



Компания «ЭлектроПласт» предлагает заключение долгосрочных отношений при поставках импортных электронных компонентов на взаимовыгодных условиях!

Наши преимущества:

- Оперативные поставки широкого спектра электронных компонентов отечественного и импортного производства напрямую от производителей и с крупнейших мировых складов;
- Поставка более 17-ти миллионов наименований электронных компонентов;
- Поставка сложных, дефицитных, либо снятых с производства позиций;
- Оперативные сроки поставки под заказ (от 5 рабочих дней);
- Экспресс доставка в любую точку России;
- Техническая поддержка проекта, помощь в подборе аналогов, поставка прототипов;
- Система менеджмента качества сертифицирована по Международному стандарту ISO 9001;
- Лицензия ФСБ на осуществление работ с использованием сведений, составляющих государственную тайну;
- Поставка специализированных компонентов (Xilinx, Altera, Analog Devices, Intersil, Interpoint, Microsemi, Aeroflex, Peregrine, Syfer, Eurofarad, Texas Instrument, Miteq, Cobham, E2V, MA-COM, Hittite, Mini-Circuits, General Dynamics и др.);

Помимо этого, одним из направлений компании «ЭлектроПласт» является направление «Источники питания». Мы предлагаем Вам помощь Конструкторского отдела:

- Подбор оптимального решения, техническое обоснование при выборе компонента;
- Подбор аналогов;
- Консультации по применению компонента;
- Поставка образцов и прототипов;
- Техническая поддержка проекта;
- Защита от снятия компонента с производства.



Как с нами связаться

Телефон: 8 (812) 309 58 32 (многоканальный)

Факс: 8 (812) 320-02-42

Электронная почта: org@eplast1.ru

Адрес: 198099, г. Санкт-Петербург, ул. Калинина, дом 2, корпус 4, литера А.