

Discontinued: 14.7kPa type
Last time buy: August 31, 2012

Panasonic
 ideas for life

**ULTRA SMALL
 HIGHLY SEMICONDUCTOR
 PRESSURE SENSOR**

**PS PRESSURE
 SENSOR**

**Ultra-small
 miniature**

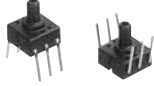

<Cross-section of Sensor Chip>

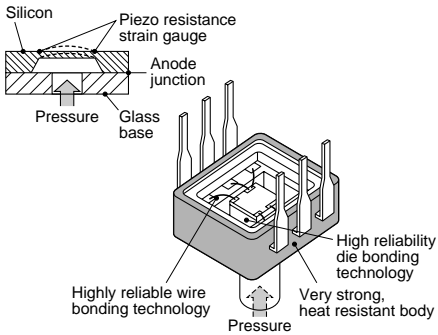

RoHS compliant

FEATURES

1. Ultra-miniature size: much more compact than the PF pressure sensors offered in the past

- Base area: 7.2(W) x 7.2(D) mm
 .283(W) x .283(D) inch
- Only 60% in mounting area and 91% in overall height of previous models (PF)

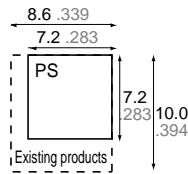

2. High-level precision and linearity
 A high degree of precision and linear detector response have been achieved by applying the semiconductor strain gauge system. Highly reproducible based on repeated pressure.

3. Impressive line-up of models

- Taking their place alongside the standard 5kW bridge resistance models are those with a 3.3kW resistance which is optimally suited to 5V drive circuits.
- Economy model (no glass base) gives outstanding value for consumer appliances
 40 kPa (0.4 kgf/cm²) and 49 kPa (0.5 kgf/cm²) units are also available.

4. Improved ease of DIP pin insertion into printed circuit boards

The ends of the DIP pins are chamfered to ensure easy insertion into printed circuit boards.

Example of pressure characteristics (ADP41410)

Drive current: 1.5 mA rated current;
 ambient temperature: 25°C 77°F

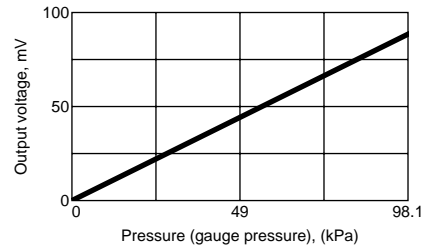



TYPICAL APPLICATIONS

- Medical equipment: Electronic hemodynamometer
- Home appliance: Vacuum cleaner
- Gas equipment: Microprocessor gas meter, gas leakage detector
- Industrial equipment: Absorption device, etc.

ORDERING INFORMATION





Ex. ADP 4

Part No.	Terminal profile and direction	Rated pressure	Type	Bridge resistance
ADP4: PS pressure sensor	1: DIP terminal: Direction opposite the pressure inlet direction  2: DIP terminal: Pressure inlet direction 	0: 4.9 kPa ⚠ 1: 14.7 kPa 2: 34.3 kPa 3: 49.0 kPa 4: 98.1 kPa 5: 196.1 kPa 6: 343.2 kPa 7: 490.3 kPa 8: 833.6 kPa 9: 980.7 kPa A: 40.0 kPa	1: Standard type (With glass base) 2: Economy type (Without glass base)	0: 5.0kΩ 3: 3.3kΩ



Note: Some part numbers may not be available depending on the combination. Please refer to the Table of Product Types, below.

PRODUCT TYPES

1. DIP terminal

Pressure	Terminal	5.0kΩ		3.3kΩ	
		DIP terminal: Direction opposite the pressure inlet direction 	DIP terminal: Pressure inlet direction 	DIP terminal: Direction opposite the pressure inlet direction 	DIP terminal: Pressure inlet direction 
Standard type (with glass base)	4.9kPa	ADP41010	ADP42010	—	—
	 14.7kPa	ADP41110	ADP42110	—	—
	34.3kPa	ADP41210	ADP42210	—	—
	49.0kPa	ADP41310	ADP42310	—	—
	98.1kPa	ADP41410	ADP42410	ADP41413	ADP42413
	196.1kPa	ADP41510	ADP42510	—	—
	343.2kPa	ADP41610	ADP42610	—	—
	490.3kPa	ADP41710	ADP42710	—	—
	833.6kPa	ADP41810	ADP42810	—	—
Economy type (without glass base)	40.0kPa	—	—	ADP41A23	ADP42A23
	49.0kPa	ADP41320	ADP42320	—	—

SPECIFICATIONS

Type	Standard type (With glass base)												Economy type (Without glass base)		
Type of pressure	Gauge pressure														
Pressure medium	Air (For other medium, please consult us.)														
Rated pressure	Unit: kPa	4.9	 14.7	34.3	49.0	98.1	196.1	343.2	490.3	833.6	980.7	98.1	980.7	40.0	49.0
Max. applied pressure	Twice the rated pressure									1.5 times the rated pressure	Twice the rated pressure	1.5 times the rated pressure	Twice the rated pressure		
Bridge resistance	5000±1000 Ω											3300±700 Ω		3300 ±600 Ω	5000 ±1000 Ω
Ambient temperature	-20 to 100°C -4 to 212°F (no freezing or condensation)												-5 to +50°C +23 to +122°F	-20 to +100°C -4 to +212°F	
Storage temperature	-40 to 120°C -40 to 248°F (no freezing or condensation)												-20 to +70°C -4 to +158°F	-40 to +120°C -40 to +248°F	
Standard temperature	25°C 77°F											30°C 86°F		25°C 77°F	
Temperature compensation range	0 to 50°C 32 to 122°F											0 to 60°C 32 to 140°F		5 to 45°C 41 to 113°F	0 to 50°C 32 to 122°F
Drive current (constant current)	1.5 mA DC											1.0 mA DC		1.5 mA DC	
Output span voltage	40±20 mV	100±40 mV									65±25 mV		43.5±22.5 mV	85±45 mV	
Offset voltage	±20 mV														
Linearity	±0.7%FS	 ±0.5%FS	±0.3%FS				±0.5%FS	±0.6%FS		±1.0%FS			±0.3%FS		
Pressure hysteresis	±0.6%FS	 ±0.4%FS	±0.2%FS				±0.4%FS			±1.0%FS			±0.7%FS		
Offset voltage-temperature characteristics (0 to 50°C 32 to 122°F)	±15%FS	±5.0%FS									±3.5%FS		±10%FS	±8%FS	
Sensitivity-temperature characteristics (0 to 50°C 32 to 122°F)	±10%FS	±2.5%FS									±1.3%FS		±1.3%FS	±2.5%FS	

- Notes) 1. Unless otherwise specified, measurements were taken with a drive current of ±0.01 mA and humidity ranging from 25% to 85%.
2. Please consult us if a pressure medium other than air is to be used.
3. This is the regulation which applies within the compensation temperature range.
4. Please consult us if the intended use involves a negative pressure.

DATA

1. Characteristics data

1-(1) Output characteristics

ADP41913
 Drive current: 1.0 mA; temperature: 30°C 86°F

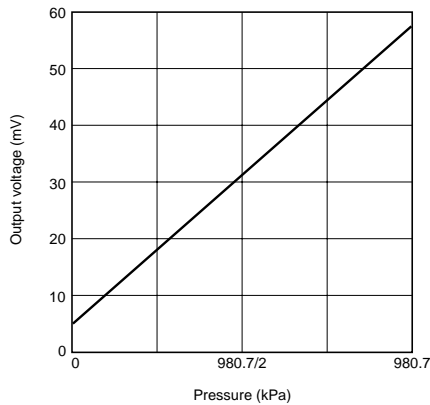

1-(2) Offset voltage – temperature characteristics

ADP41913
 Drive current: 1.0 mA; rating ±3.5%FS

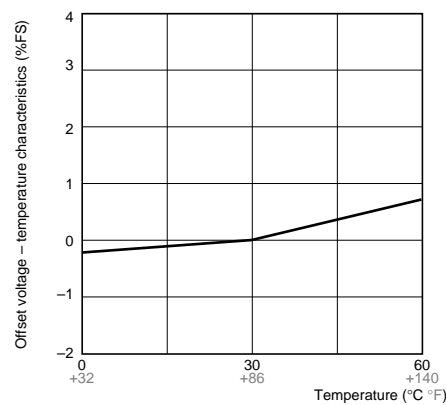

1-(3) Sensitivity – temperature characteristics (%FS)

ADP41913
 Drive current: 1.0 mA; rating ±2.5%FS

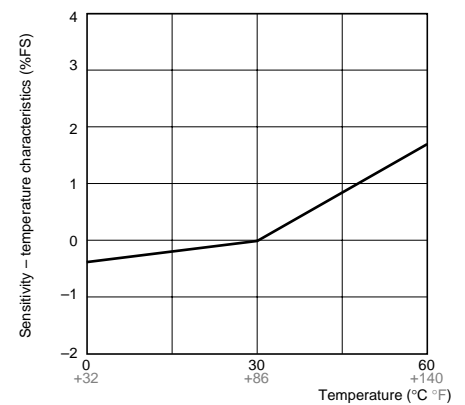

2. Pressure cycle range (0 to rated pressure)

Tested sample: ADP41913, temperature: 100°C 212°F, No. of cycle: 1×10⁶

2-(1) Offset voltage range

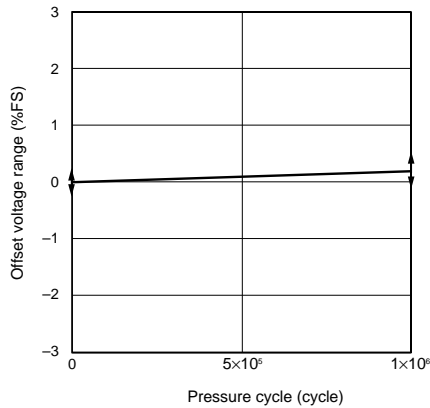

2-(2) Output span voltage range

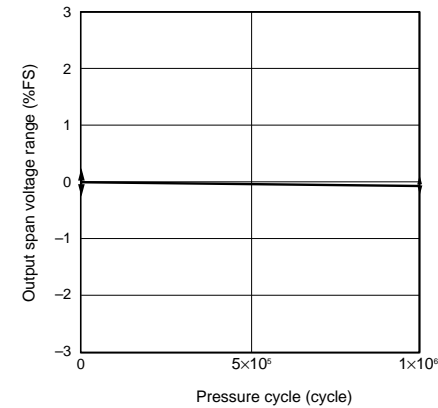

Even after testing for 1 million times, the variations in the offset voltage and output span voltage are minimal.

3. Evaluation test

	Tested item	Tested condition	Result
Environmental characteristics	Storage at high temperature	Temperature: Left in a 120°C 248°F constant temperature bath Time: 1,000 hrs.	Passed
	Storage at low temperature	Temperature: Left in a -40°C -40°F constant temperature bath Time: 1,000 hrs.	Passed
	Humidity	Temperature/humidity: Left at 40°C 104°F, 90% RH Time: 1,000 hrs.	Passed
	Temperature cycle	Temperature: -40°C to 120°C -40°F to 248°F 1 cycle: 30 min. Times of cycle: 100	Passed
Endurance characteristics	High temperature/high humidity operation	Temperature/humidity: 40°C 104°F, 90% RH Operation times: 10 ⁶ , rated voltage applied	Passed
Mechanical characteristics	Vibration resistance	Double amplitude: 1.5 mm .059 inch Vibration: 10 to 55 Hz Applied vibration direction: X, Y, Z 3 directions Times: 2 hrs each	Passed
	Dropping resistance	Dropping height: 75 cm 29.528 inch Times: 2 times	Passed
	Terminal strength	Pulling strength: 9.8 N {1 kgf}, 10 sec. Bending strength: 4.9 N {0.5 kgf}, left and right 90° 1 time	Passed
Soldering Resistance	Soldered in DIP soldering bath	Temperature: 230°C 446°F Time: 5 sec.	Passed
	Temperature	Temperature: 260°C 500°F Time: 10 sec.	Passed

Note: For details other than listed above, please consult us.

DIMENSIONS

mm inch General tolerance: $\pm 0.3 \pm .012$

1. Terminal direction: DIP terminal Direction opposite the pressure inlet direction ADP41□□□

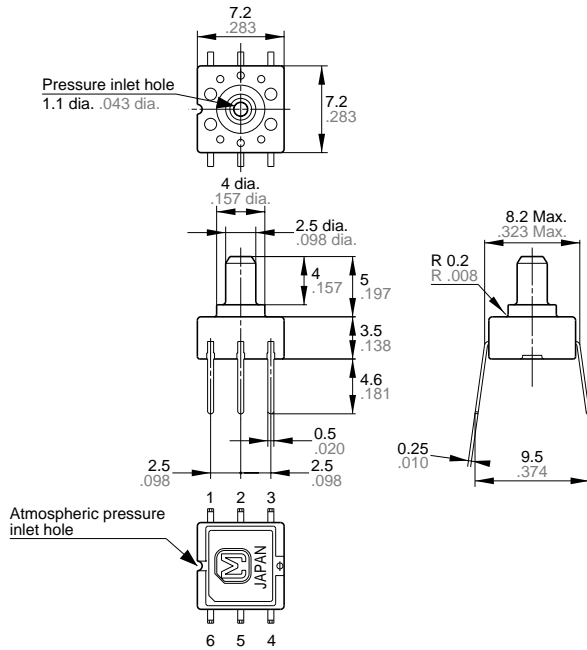

Recommended PC board pattern (BOTTOM VIEW)

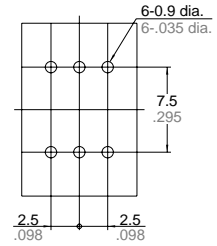

Tolerance: $\pm 0.1 \pm .004$

Terminal connection diagram

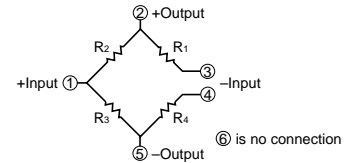

Terminal No.	Name
1	Power supply (+)
2	Output (+)
3	Power supply (-)
4	Power supply (-)
5	Output (-)
6	No connection

Note: Leave terminal 6 unconnected.

2. Terminal direction: DIP terminal Pressure inlet direction ADP42□□□

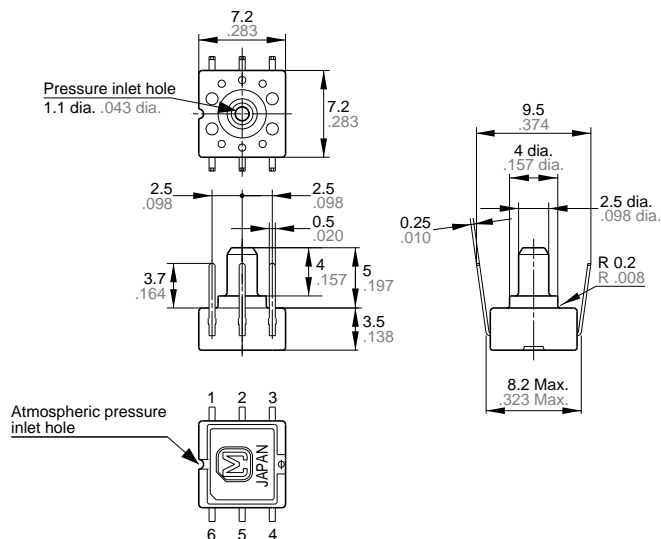

Recommended PC board pattern (BOTTOM VIEW)

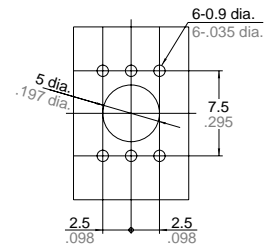

Tolerance: $\pm 0.1 \pm .004$

Terminal connection diagram

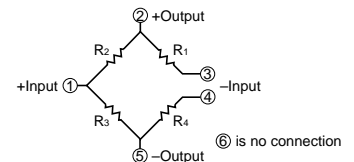

Terminal No.	Name
1	Power supply (+)
2	Output (+)
3	Power supply (-)
4	Power supply (-)
5	Output (-)
6	No connection

Note: Leave terminal 6 unconnected.

NOTES

1. Mounting

Use lands on the printed-circuit boards to which the sensor can be securely fixed.

2. Soldering

Due to its small size, the thermal capacity of the pressure sensor DIP type is low. Therefore, take steps to minimize the effects of external heat.

Damage and changes to characteristics may occur due to heat deformation.

Use a non-corrosive resin type of flux.

Since the pressure sensor DIP type is exposed to the atmosphere, do not allow flux to enter inside.

1) Manual soldering

- Set the soldering tip from 260 to 300°C 500 to 572°F (30W), and solder for no more than 5 seconds.

- Please note that output may change if the pressure is applied on the terminals when the soldering.

- Thoroughly clean the soldering iron.

2) DIP soldering (DIP terminal type)

- Please keep the DIP solder bath temperature no higher than 260°C 500°F. When soldering, heat should be applied no longer than five seconds.

- When mounting onto a PCB of low thermal capacity, please avoid DIP soldering as this may cause heat deformity.

3) Solder reworking

- Finish reworking in one operation.

- For reworking of the solder bridge, use a soldering iron with a flat tip. Please do not add more flux when reworking.

- Please use a soldering iron that is below the temperature given in the specifications in order to maintain the correct temperature at the tip of the soldering iron.

4) Too much force on the terminals will cause deformation and loss in effectiveness of the solder. Therefore, please avoid dropping and careless handling of the product.

5) Please control warping of the PCB within 0.05 mm of the sensor width.

6) When cut folding the PCB after mount-

ing the sensor, take measures to prevent stress to the soldered parts.

7) The sensor terminals are designed to be exposed, so contact of the terminals with metal shards and the like will cause output errors. Therefore, please be careful and prevent things such as metal shards and hands from contacting the terminals.

8) To prevent degradation of the PCB insulation after soldering, please be careful not to get chemicals on the sensor when coating.

9) Please consult us regarding the use of lead-free solder.

3. Cleaning

1) Since the pressure sensor chip is exposed to the atmosphere, do not allow cleaning fluid to enter inside.

2) Avoid ultrasonic cleaning since this may cause breaks or disconnections in the wiring.

4. Environment

1) Please avoid using or storing the pressure sensor chip in a place exposed to corrosive gases (such as the gases given off by organic solvents, sulfurous acid gas, hydrogen sulfides, etc.) which will adversely affect the performance of the pressure sensor chip.

2) Since this pressure sensor chip does not have a water-proof construction, please do not use the sensor in a location where it may be sprayed with water, etc.

3) Avoid using the pressure sensors chip in an environment where condensation may form.

Furthermore, its output may fluctuate if any moisture adhering to it freezes.

4) The pressure sensor chip is constructed in such a way that its output will fluctuate when it is exposed to light. Especially when pressure is to be applied by means of a transparent tube, take steps to prevent the pressure sensor chip from being exposed to light.

5) Avoid using the pressure sensor chip where it will be susceptible to ultrasonic or

other high-frequency vibration.

5. Quality check under actual loading conditions

To assure reliability, check the sensor under actual loading conditions. Avoid any situation that may adversely affect its performance.

6. Other handling precautions

1) That using the wrong pressure range or mounting method may result in accidents.

2) The only direct pressure medium you can use is dry air. The use of other media, in particular, corrosive gases (organic solvent based gases, sulfurous acid based gases, and hydrogen sulfide based gases, etc.) and media that contains moisture or foreign substances will cause malfunction and damage. Please do not use them.

3) The pressure sensor chip is positioned inside the pressure inlet. Never poke wires or other foreign matter through the pressure inlet since they may damage the chip or block the inlet. Avoid use when the atmospheric pressure inlet is blocked.

4) Use an operating pressure which is within the rated pressure range. Using a pressure beyond this range may cause damage.

5) Since static charge can damage the pressure sensor chip, bear in mind the following handling precautions.

- When storing the pressure sensor chips, use a conductive material to short the pins or wrap the entire chip in aluminum foil. Plastic containers should not be used to store or transport the chips since they readily become charged.

- When using the pressure sensor chips, all the charged articles on the bench surface and the work personnel should be grounded so that any ambient static will be safely discharged.

6) Based on the pressure involved, give due consideration to the securing of the pressure sensor DIP type and to the securing and selection of the inlet tube. Consult us if you have any queries.

APPLICATION CIRCUIT DIAGRAM (EXAMPLE)

The pressure sensor is designed to convert a voltage by means of constant current drive and then, if necessary, it amplifies the voltage for use. The circuit shown below is a typical example of a circuit in which the pressure sensor is used.

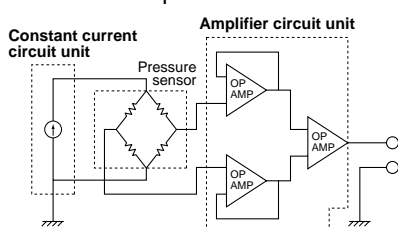

MOUNTING METHOD

The general method for transmitting air pressures differs depending on whether the pressure is low or high.

• Checkpoints for use

<1> Select a pressure inlet pipe which is sturdy enough to prevent pressure leaks.

<2> Fix the pressure inlet pipe securely so as to prevent pressure leaks.

<3> Do not block the pressure inlet pipe.

Methods of transmitting air pressures

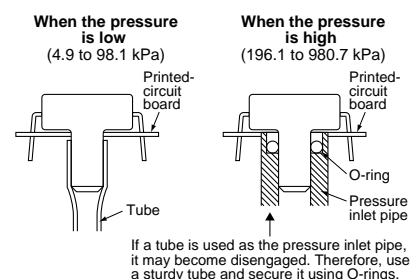

If a tube is used as the pressure inlet pipe, it may become disengaged. Therefore, use a sturdy tube and secure it using O-rings.



Компания «ЭлектроПласт» предлагает заключение долгосрочных отношений при поставках импортных электронных компонентов на взаимовыгодных условиях!

Наши преимущества:

- Оперативные поставки широкого спектра электронных компонентов отечественного и импортного производства напрямую от производителей и с крупнейших мировых складов;
- Поставка более 17-ти миллионов наименований электронных компонентов;
- Поставка сложных, дефицитных, либо снятых с производства позиций;
- Оперативные сроки поставки под заказ (от 5 рабочих дней);
- Экспресс доставка в любую точку России;
- Техническая поддержка проекта, помощь в подборе аналогов, поставка прототипов;
- Система менеджмента качества сертифицирована по Международному стандарту ISO 9001;
- Лицензия ФСБ на осуществление работ с использованием сведений, составляющих государственную тайну;
- Поставка специализированных компонентов (Xilinx, Altera, Analog Devices, Intersil, Interpoint, Microsemi, Aeroflex, Peregrine, Syfer, Eurofarad, Texas Instrument, Miteq, Cobham, E2V, MA-COM, Hittite, Mini-Circuits, General Dynamics и др.);

Помимо этого, одним из направлений компании «ЭлектроПласт» является направление «Источники питания». Мы предлагаем Вам помощь Конструкторского отдела:

- Подбор оптимального решения, техническое обоснование при выборе компонента;
- Подбор аналогов;
- Консультации по применению компонента;
- Поставка образцов и прототипов;
- Техническая поддержка проекта;
- Защита от снятия компонента с производства.



Как с нами связаться

Телефон: 8 (812) 309 58 32 (многоканальный)

Факс: 8 (812) 320-02-42

Электронная почта: org@eplast1.ru

Адрес: 198099, г. Санкт-Петербург, ул. Калинина, дом 2, корпус 4, литера А.