

# COAXIAL, TRIAXIAL, MULTI & MIXED CONNECTORS

SHORT FORM  
CATALOGUE



 **LEMO**<sup>®</sup>

## Precision modular connectors to suit your application

Since its creation in Switzerland in 1946 the LEMO Group has been recognized as a global leader of circular Push-Pull connectors and connector solutions. Today LEMO and its affiliated companies, REDEL and COELVER, are active in more than 80 countries with the help of over 40 subsidiaries and distributors.

### Over 75000 connectors

The modular design of the LEMO range provides over 75000 connectors from miniature  $\varnothing$  3 mm to  $\varnothing$  50 mm, capable of handling cable diameters up to 30 mm and for up to 114 contacts.

This vast portfolio enables you to select the ideal connector configuration to suit almost any specific requirement in most markets, including medical devices, test and measurement instruments, machinery, audio video broadcast, telecommunications and military.

### LEMO's Push-Pull Self-Latching Connection System

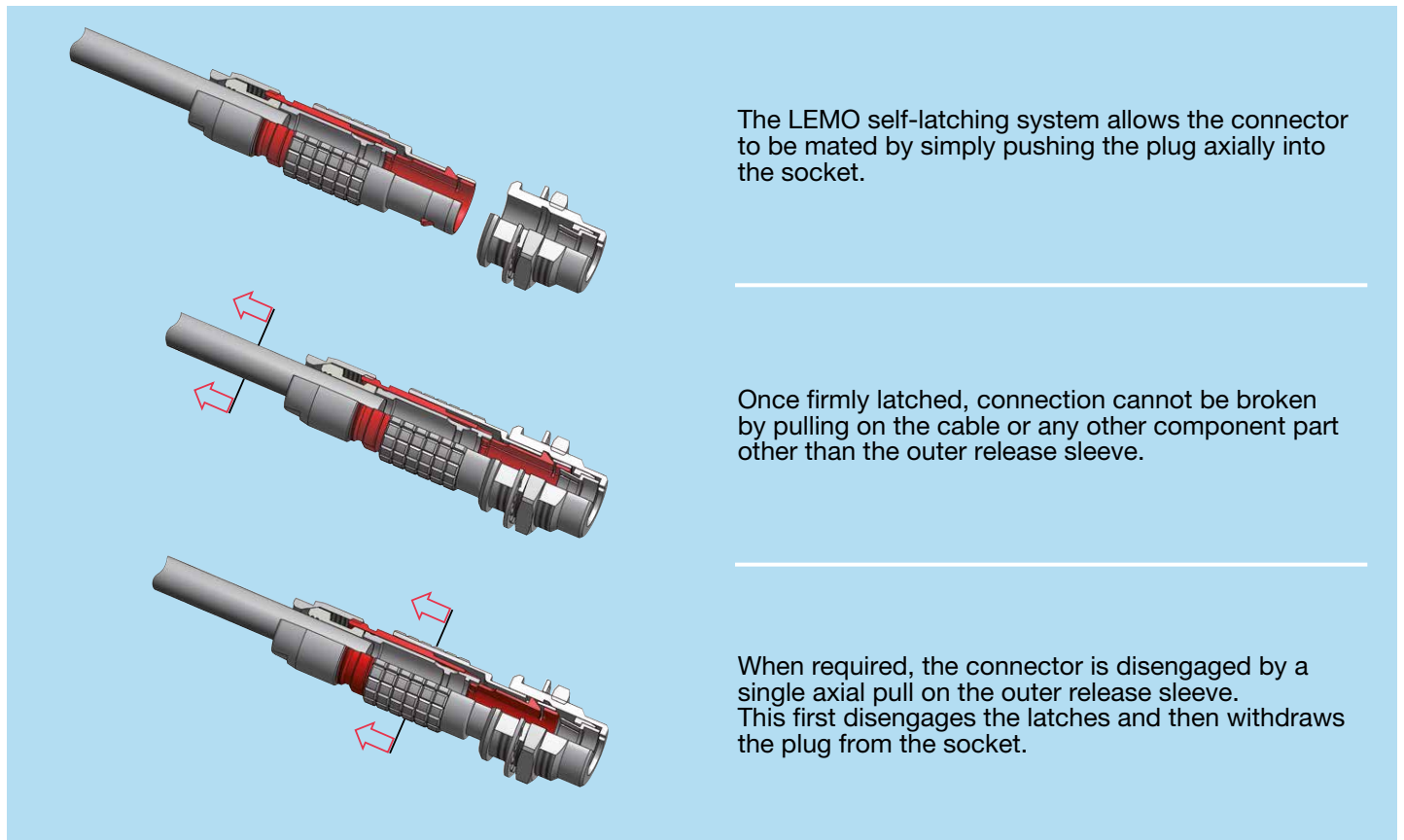

This self-latching system is renowned worldwide for its easy and quick mating and unmating features. It provides absolute security against vibration, shock or pull on the cable, and facilitates operation in a very limited space.



### UL Recognition

LEMO connectors are recognized by the Underwriters Laboratories (UL). The approval of the complete system (LEMO connector, cable and your equipment) will be easier because LEMO connectors are recognized.

### CE marking

CE marking  means that the appliance or equipment bearing it complies with the protection requirements of one or several European safety directives. CE marking  applies to complete products or equipment, **but not to electromechanical components, such as connectors.**

### RoHS

LEMO connector specifications conforms the requirements of the RoHS directive (2011/65/EU) of the European Parliament and the latest amendments. This directive specifies the restrictions of the use of hazardous substances in electrical and electronic equipment marketed in Europe.

## Introduction

This catalogue gives the complete description of LEMO connectors with coaxial, triaxial and mixed contacts. Mixed contacts include coaxial and low voltage contact configurations, as well as multi-coaxial contact configurations.

The LEMO manufacturing programme has been extended to almost 40 series divided into 7 product families with specific mating and environmental characteristics. Each series includes a wide variety of plug, socket and coupler models, available in contact configurations adapted to all round cables. The catalogue includes the B, K, S and E Series of the LEMO product range. In addition the 00 Series (triaxial) connector is also represented.

Watertight and vacuumtight models are also available. Since LEMO connectors are perfectly screened and designed to guarantee very low resistance to shell electrical continuity, they are particularly adapted to applications where electromagnetic compatibility (EMC) is important.

## Material and treatment

Component	Material (Standard)	Surface treatment ( $\mu\text{m}$ )										Notes
		chrome			nickel		gold			black chr.		
		Cu	Ni	Cr	Cu	Ni	Cu	Ni	Au	Ni	Cr	
Outer shell, collet nut, conical nut or notched nut and oversized collet	Brass (UNS C 38500)	0.5	3	0.3	0.5	3	0.5	3	0.5	1	2	
	Stainless steel (AISI 303, 304 or 316L)	without treatment										
	Aluminium alloy (AA 6262A or AA 6023)	anodized										
	POM (Delrin® or Ertacetel®), Polyoxymethylene, black	–										1)
	PEEK, Polyether ethercetone, beige	–										2)
	PSU (Udel®), Polysulfone, grey or white	–										3)
	PPSU (Radel®), Polyphenylsulfone, cream	–										3)
	PPS (Ryton®), Polyphenilene sulfide, brown	–										4)
Earthing crown	Bronze (UNS C 54400) or special brass	–	–	–	0.5	3	0.5	3	1.0	–	–	5)
	Beryllium Copper (UNS C 17300)	–	–	–	0.5	3	0.5	3	1.0	–	–	6)
	Stainless steel (AISI 416 or 316L)	without treatment										7)
Latch sleeve	Special brass	0.5	3	0.3	0.5	3	0.5	3	0.5	–	–	
	Stainless steel (AISI 416 or 316L)	without treatment										7)
Locking washer	Bronze (UNS C 52100)	–	–	–	0.5	3	0.5	3	0.5	–	–	
Hexagonal or round nut	Brass (UNS C 38500)	–	–	–	0.5	3	0.5	3	0.5	–	–	
	Stainless steel (AISI 303, 304 or 316L)	without treatment										8)
	Aluminium alloy (AA 6262A or AA 6023)	anodized natural										8)
Other metallic components	Brass (UNS C 38500)	–	–	–	0.5	3	0.5	3	0.5	–	–	
	Stainless steel (AISI 303, 304 or 316L)	without treatment										
O-ring and gaskets	Silicone MQ/MVQ or FPM/FKM (Viton®)	–										9)
Sealing resin	Epoxy (Araldite® or Stycast®)	–										

### Notes:

standards for surface treatment are as follows:

- chrome-plated: SAE AMS 2460
- nickel-plated: SAE AMS QQ N 290, or MIL DTL 32119
- gold-plated: ISO 27874
- black chrome: MIL-C-14538C with a minimum of 10  $\mu\text{m}$  of lacquer protection

<sup>1)</sup> for FFP, PCP and ERN models of the 0S to 3S series

<sup>2)</sup> for FFP, PCP and ERN models of the 0S to 3S series, FGG and ENG models of the 0B, 1B, 3B and 4B series, FFA and FFC models of the 00 triaxial series

<sup>3)</sup> for the FGG, FGY and ENY models of the 2B to 4B series

<sup>4)</sup> for 00 triaxial series (elbow sockets for printed circuits)

<sup>5)</sup> gold-plating for unipole types

<sup>6)</sup> used in 00 series free and fixed sockets

<sup>7)</sup> AISI 416 steel is used with shells made of AISI 303 or 304

<sup>8)</sup> delivered with free and fixed sockets with aluminium alloy or stainless steel shell

<sup>9)</sup> FPM/FKM (Viton®) o-ring and gaskets are installed upon special request. However standard for vacuumtight models.

# B Series

B series connectors provide the following main features:

- security of the Push-Pull self-latching system
- coaxial, triaxial and mixed contact configurations
- plastic models made of PSU or PPSU
- multiple key options to avoid cross mating of similar connectors («G» key standard).
- up to 10 coaxial contacts
- solder or crimp contacts
- high packing density for space savings
- 360° screening for full EMC shielding

## Metal housing models

### Fixed plugs



FWG

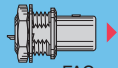

FAG

### Elbow plugs

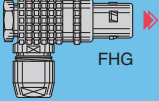

FHG

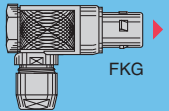

FKG

### Straight plugs

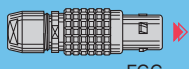

FGG

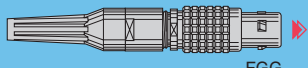

FGG

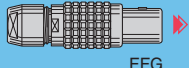

FFG

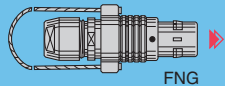

FNG

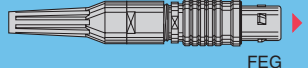

FEG

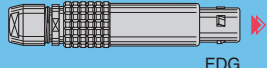

FDG

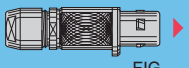

FIG

### Fixed sockets



EGG



ENG



EKG



EHG



EJG



EEG



EEG



ECG

### Free sockets

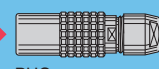

PHG

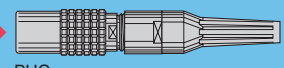

PHG



PNG



PKG



PFG



PEG



PEG

## Plastic housing models

### Straight plugs

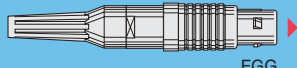

FGG

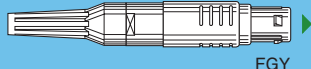

FGY

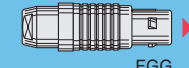

FGG

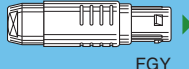

FGY

### Fixed sockets

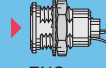

ENG



ENY

## Model Description

- ECG** Fixed socket with two nuts, key (G) or keys (A...L and R) (back panel mounting)
- EEG** Fixed socket, nut fixing, key (G) or keys (A...L and R) (back panel mounting)
- EGG** Fixed socket, nut fixing, key (G) or keys (A...L and R)
- EHG** Fixed socket, nut fixing, key (G) or keys (A...L and R), and protruding shell
- EJG** Fixed socket, press or adhesive fit, key (G) or keys (A...L)
- EKG** Fixed socket, nut fixing, key (G) or keys (A...L and R), special alignment mark on the front
- ENG** Fixed socket with earthing tag, nut fixing, key (G) or keys (A...L)
- ENG** Fixed socket with earthing tag, nut fixing, key (G or J), PEEK outer shell
- ENY** Fixed socket with earthing tag, nut fixing, keys (Y), PSU or PPSU outer shell
- FAG** Fixed plug, non-latching, nut fixing, key (G) or keys (A...L and R)
- FDG** Straight plug, long version, key (G) or keys (A...L), cable collet

- FEG** Straight plug, key (G) or keys (A...L), cable collet, front seal and nut for fitting a bend relief (IP 54 protection index when mated)
- FFG** Straight plug, non-latching, key (G) or keys (A...L), cable collet
- FGG** Straight plug, key (G) or keys (A...L and R), cable collet
- FGG** Straight plug, key (G) or keys (A...L), cable collet and nut for fitting a bend relief
- FGG** Straight plug, key (G or J), cable collet, PEEK outer shell
- FGG** Straight plug, key (G or J), cable collet, PEEK outer shell, nut for fitting a bend relief
- FGY** Straight plug, keys (Y), cable collet and PSU or PPSU outer shell
- FGY** Straight plug, keys (Y), cable collet and PSU or PPSU outer shell and nut for fitting a bend relief
- FHG** Elbow (90°) plug, key (G) or keys (A...L and R), cable collet
- FIG** Straight plug for remote handling, key (G) or keys (A...L and R), special alignment mark, knurled handling surface, cable collet

- FKG** Elbow (90°) plug for remote handling, key (G) or keys (A...L), special alignment mark, knurled handling surface, cable collet
- FNG** Straight plug, key (G) or keys (A...L and R), cable collet and lanyard release
- FWG** Fixed plug, nut fixing, key (G) or keys (A...L)
- PEG** Fixed socket, nut fixing, key (G) or keys (A...L), cable collet (back panel mounting)
- PFG** Fixed socket, with two nuts, key (G) or keys (A...L and R), cable collet (back panel mounting)
- PHG** Free socket, key (G) or keys (A...L and R), cable collet
- PHG** Free socket, key (G) or keys (A...L), cable collet and nut for fitting a bend relief
- PKG** Fixed socket, nut fixing, key (G) or keys (A...L and R), cable collet
- PNG** Free socket, nut fixing, key (G) or keys (A...L and R), cable collet with lanyard release

## Part Numbering System

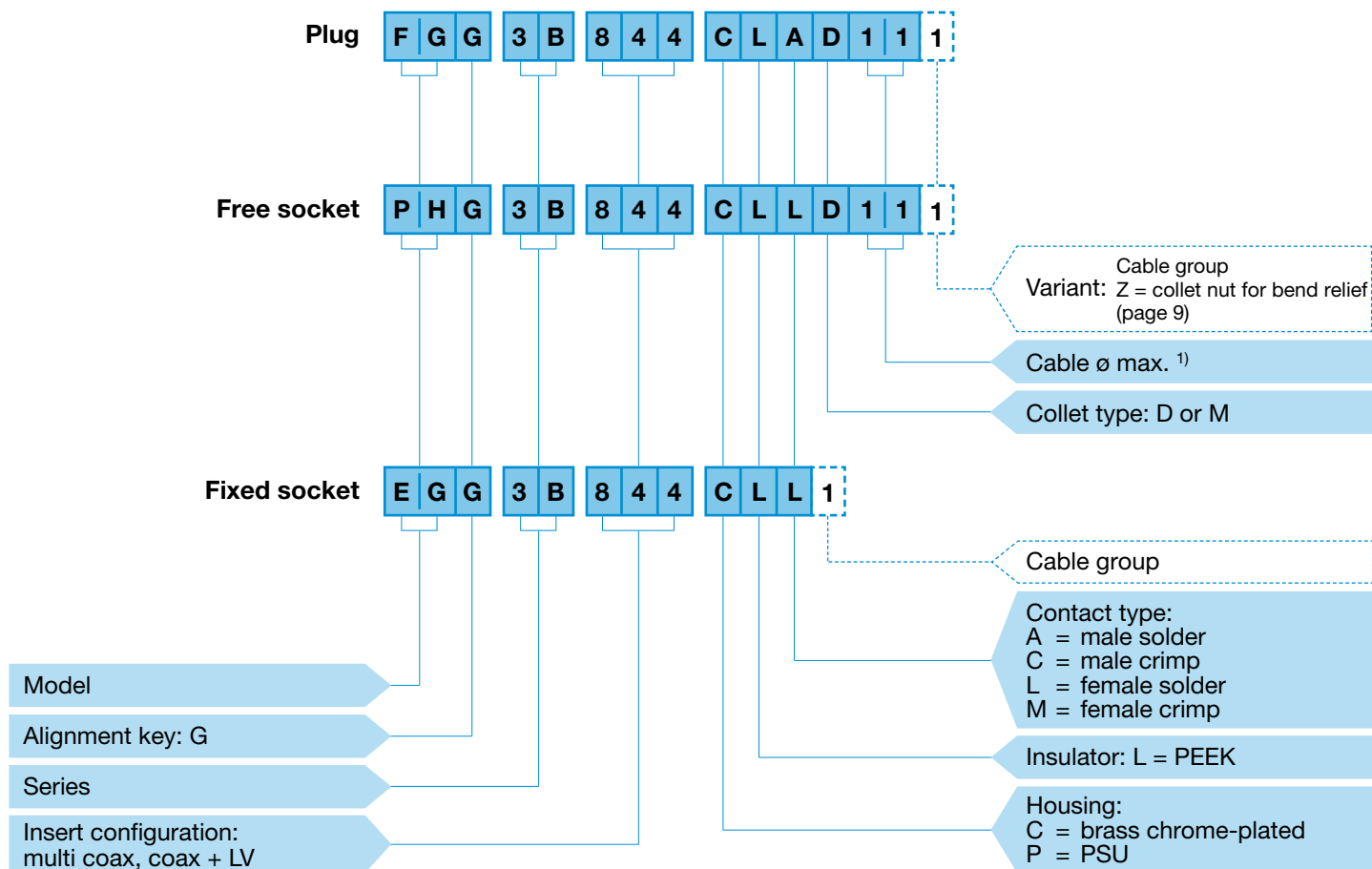

**FGG.3B.844.CLAD111** = straight plug with key (G) and cable collet, 3B series, mixed coax & low voltage type (1 coax and 4 low voltage contacts), outer shell in chrome-plated brass, PEEK insulator, male solder contacts, D type collet for up to 11 mm diameter cable. Cable group 1.

**PHG.3B.844.CLLD111** = free socket with key (G) and cable collet, 3B series, mixed coax & low voltage type (1 coax and 4 low voltage contacts), outer shell in chrome-plated brass, PEEK insulator, female solder contacts, D type collet for up to 11 mm diameter cable. Cable group 1.

**EGG.3B.844.CLL1** = fixed socket, nut fixing, with key (G), 3B series, mixed coax & low voltage type (1 coax and 4 low voltage contacts), outer shell in chrome plated brass, PEEK insulator, female solder contacts. Cable group 1.

**Note:** <sup>1)</sup> see unipole-multipole catalogue.

## Part Section Showing Internal Components (mixed coax + LV)

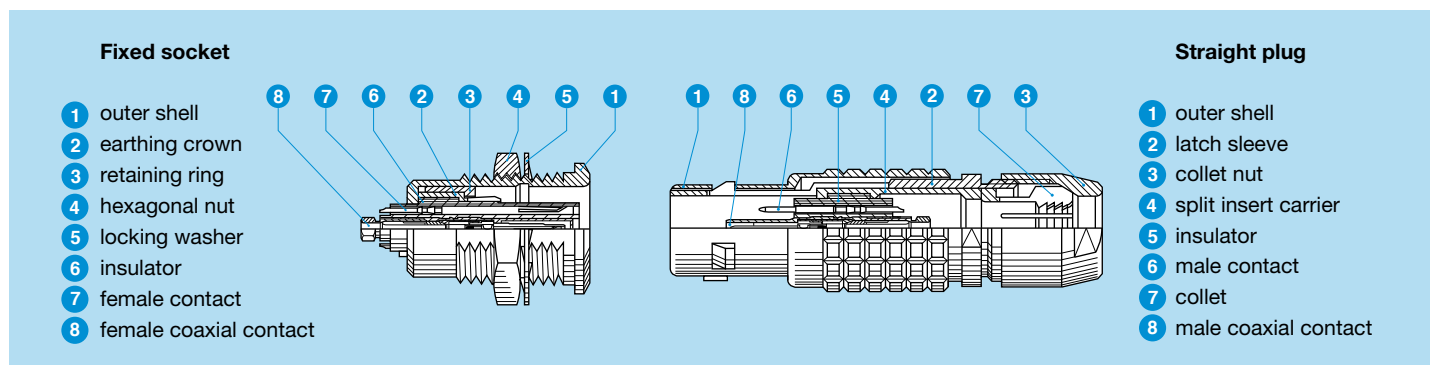

# K Series

K series connectors have been specifically designed for outdoor applications.

They include an inner sleeve and two seals to prevent penetration of solids or liquids into the housing formed by the plug, free socket or fixed socket. All models of this series are watertight when mated to give a protection index of IP68 as per IEC 60529 standard (in mated condition) when correctly assembled to an appropriate cable (IP66 otherwise).

K series connectors have the same insulators as the B series and have the following main features:

- security of the Push-Pull latching system
- coaxial, triaxial and mixed contact configurations
- solder or crimp contacts
- multiple key options to avoid cross mating of similar connectors («G» key standard)
- watertight connection (IP 68/IP 66)
- up to 10 coaxial contacts
- 360° screening for full EMC shielding
- high packing density for space savings
- rugged housing for extreme working conditions.

## Models

### Fixed plugs

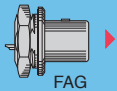
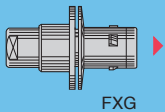

### Elbow plug

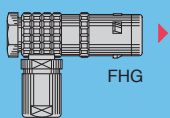

### Straight plugs

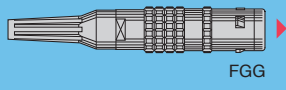
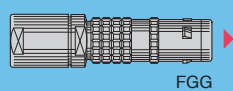
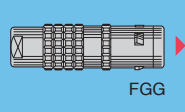

### Fixed sockets

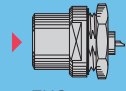
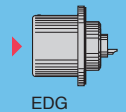
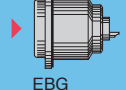
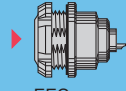
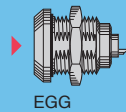

### Free sockets

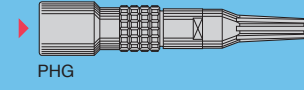
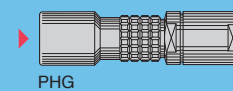
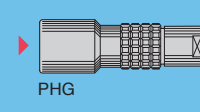

### Fixed sockets

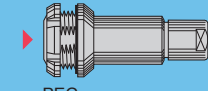
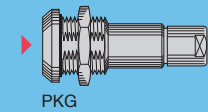

## Model Description

**EBG** Fixed socket with square flange, key (G) or keys (A to F, L and R) and screw fixing

**EDG** Fixed socket with square flange, key (G) or keys (A to F, L and R), protruding shell and earthing tag, screw fixing

**EEG** Fixed socket, nut fixing, key (G) or keys (A to F, L and R) (back panel mounting)

**EGG** Fixed socket, nut fixing, key (G) or keys (A to F, L and R)

**EHG** Fixed socket, nut fixing, key (G) or keys (A to F and L), protruding shell

**FAG** Fixed plug, nut fixing, non-latching, key (G) or keys (A to F, L and R)

**FGG** Straight plug, key (G) or keys (A to F, L and R), cable collet

**FGG** Straight plug, key (G) or keys (A to F, L and R), cable collet and oversize cable collet

**FGG** Straight plug, key (G) or keys (A to F, L and R), cable collet and nut for fitting a bend relief

**FHG** Elbow (90°) plug, key (G) or keys (A to F, L and R), cable collet

**FXG** Fixed plug with round flange, key (G) or keys (A to F, L and R) and screw fixing

**PEG** Fixed socket, nut fixing, key (G) or keys (A to F, L and R), cable collet (back panel mounting)

**PHG** Free socket, key (G) or keys (A to F, L and R), cable collet

**PHG** Free socket, key (G) or keys (A to F, L and R), cable collet and oversize cable collet

**PHG** Free socket, key (G) or keys (A to F, L and R), cable collet and nut for fitting a bend relief

**PKG** Fixed socket, nut fixing, key (G) or keys (A to F, L and R), cable collet

## Part Numbering System

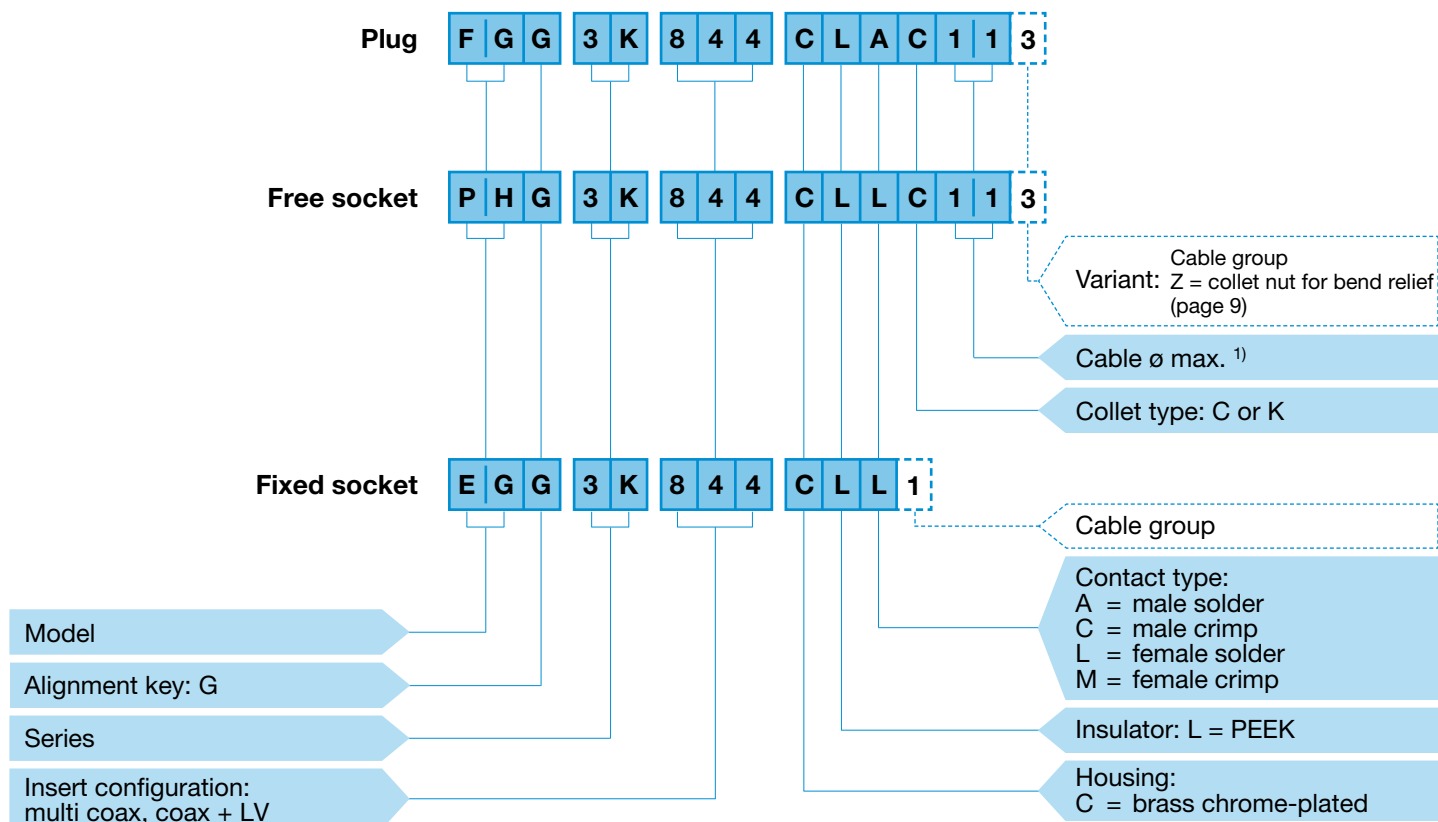

**FGG.3K.844.CLAC113** = straight plug with key (G) and cable collet, 3K series, mixed coax & low voltage type (1 coax and 4 low voltage contacts), outer shell in chrome-plated brass, PEEK insulator, male solder contacts, C type collet for 10.5 mm diameter cable. Cable group 3.

**PHG.3K.844.CLLC113** = free socket with key (G) and cable collet, 3K series, mixed coax & low voltage type (1 coax and 4 low voltage contacts), outer shell in chrome-plated brass, PEEK insulator, female solder contacts, C type collet for 10.5 mm diameter cable. Cable group 3.

**EGG.3K.844.CLL1** = fixed socket, nut fixing, with key (G), 3K series, mixed coax & low voltage type (1 coax and 4 low voltage contacts), outer shell in chrome-plated brass, PEEK insulator, female solder contacts. Cable group 1.

**Note:** <sup>1)</sup> see unipole-multipole catalogue.

## Part Section Showing Internal Components (mixed coax + LV)

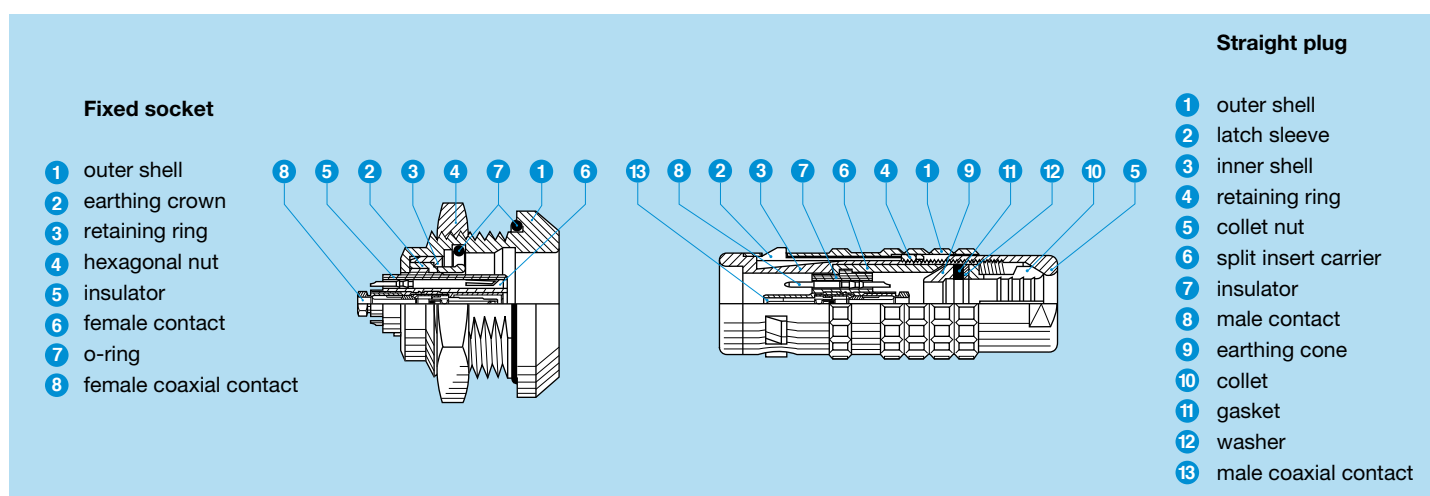

## Insert configuration (B and K series)

### Mixed: multi coax, coax + LV

		Reference	Coax				Low voltage (LV)						
			Number of contacts	Impedance (Ω)	Type (see page 10)	Cable group	Number of contacts	ø A (mm)	Contacts type		Test voltage (kV rms)	Test voltage (kV dc)	Rated current (A)
									Solder	Crimp			
<b>1B 1K</b>		<b>801</b>	1	50	F	2	1	0.9	●	●	0.85	1.20	10
		<b>803</b>	1	50	F	2	3	0.9	●	●	0.75	1.05	10
<b>2B 2K</b>		<b>802</b>	1	50	A1	1-2-3	2	0.9	●	●	0.85	1.20	10
		<b>804</b>	1	50	A1	1-2-3	4	0.7	●	●	0.75	1.05	7
		<b>806</b>	1	50	A1	1-2-3	6	0.7	●	●	0.75	1.05	7
		<b>810</b>	1	50	C	1-2-3	10	0.7	●	●	0.95	1.35	7
		<b>841</b>	2	50	E	2	1	1.6	●	●	1.90	2.70	17
		<b>232</b>	2	50	G	-	-	-	-	-	-	-	-
		<b>243</b>	3	50	E	2	-	-	-	-	-	-	-
<b>3B 3K</b>		<b>803</b>	1	50	A0	6	3	0.9	●	-	1.10	1.55	8
		<b>806</b>	1	50	A1	1-2-3	6	0.7	●	●	1.00	1.50	7
		<b>809</b>	1	50	A1	1-2-3	9	0.7	●	●	1.00	1.50	7
		<b>812</b>	1	50	A1	1-2-3	12	0.9	●	●	0.80	1.10	5
		<b>813</b>	1	50	A1	1-2-3	13	0.7	●	●	0.90	1.30	7
		<b>822</b>	1	50	C	1-2-3	22	0.7	●	●	0.70	1.00	5
		<b>844</b>	2	50	C	1-2-3	4	0.9	●	●	0.90	1.30	10
		<b>846</b>	2	50	C	1-2-3	6	0.9	●	●	0.90	1.30	10
		<b>850</b>	2	50	C	1-2-3	10	0.7	●	●	0.75	1.05	8
		<b>856</b>	2	50	C	1-2-3	16	0.7	●	●	0.70	1.00	7
		<b>242</b>	2	50	C	1-2-3	-	-	-	-	-	-	-
		<b>243</b>	3	50	C	1-2-3	-	-	-	-	-	-	-
		<b>862</b>	3	50	C	1-2-3	2	0.9	●	●	1.10	1.60	9

● First choice alternative    ○ Special order alternative



## Mixed: multi coax, coax + LV

		Reference	Coax				Low voltage (LV)						
			Number of contacts	Impedance ( $\Omega$ )	Type (see page 10)	Cable group	Number of contacts	$\phi$ A (mm)	Contacts type		Test voltage (kV rms)	Test voltage (kV dc)	Rated current (A)
									Solder	Crimp			
		<b>802</b> <b>822</b>	1	50 75	A A	5-6 4 to 6	2	0.9	●	●	1.00	1.40	12
		<b>804</b> <b>824</b>	1	50 75	A A	5-6 4 to 6	4	0.9	●	●	1.00	1.40	10
		<b>806</b> <b>826</b>	1	50 75	A A	5-6 4 to 6	6	0.9	●	●	1.00	1.40	10
		<b>842</b>	2	50	A1	1-2-3	2	0.9	●	●	1.70	2.40	12
		<b>844</b>	2	50	A1	1-2-3	4	0.9	●	●	1.70	2.40	10
		<b>852</b>	2	50	C	1-2-3	12	0.9	●	●	0.90	1.30	8
		<b>856</b>	2	50	C	1-2-3	16	0.9	●	●	0.90	1.30	8
		<b>858</b>	2	50	C	1-2-3	18	0.7	●	●	0.80	1.10	7
		<b>866</b>	3	50	C	1-2-3	6	0.7	●	●	0.80	1.10	7
		<b>885</b>	3	50	C	1-2-3	12	0.7	●	●	0.80	1.10	8
		<b>244</b>	4	50	C	1-2-3	-	-	-	-	-	-	-
		<b>879</b>	4	50	C	1-2-3	9	0.7	●	●	0.90	1.30	8
		<b>890</b>	6	50	E	2	18	0.7	●	○	0.90	1.30	5
		<b>894</b>	6	50	E	2	22	0.7	●	○	0.90	1.30	4
			<b>997<sup>1)</sup></b>	1	75	A4	N/A	32	1.3	●	○	1.20	1.70
<b>840</b>	1		50	A	5-6	40	0.9	●	●	1.30	1.80	7	

● First choice alternative    ○ Special order alternative

**Note:** <sup>1)</sup> only available in 5B series. Solution for triaxial cable fixing.

## Mixed: multi coax, coax + LV

Reference	Coax				Low voltage (LV)							
	Number of contacts	Impedance ( $\Omega$ )	Type (see page 10)	Cable group	Number of contacts	$\phi$ A (mm)	Contacts type		Test voltage (kV rms)	Test voltage (kV dc)	Rated current (A)	
							Solder	Crimp				
	868 878	1 75	B B	6 3-5	4 44	3.0 0.9	●	○	0.80	1.15	35 6	
	850 870	2 75	B B	6 3-5	10	0.9	○	●	1.40	2.00	8	
	856 876	2 75	B B	6 3-5	16	0.9	○	●	1.40	2.00	7	
	857 877	2 75	B B	6 3-5	2 15	2.0 0.9	○ ○	● ●	1.40 1.40	2.00 2.00	30 7	
	864	2	75	B0	1-6	24	1.3	●	○	0.90	1.30	8
	273	3	75	B1	5	-	-	-	-	-	-	
	274	4	75	B1	5	-	-	-	-	-	-	
	892	6	75	D	5-8-9	10	0.9	●	○	0.70	1.00	7
	260	7	75	D	5-8-9	-	-	-	-	-	-	
	240	10	50	C	1-2-3	-	-	-	-	-	-	

● First choice alternative    ○ Special order alternative

## Mixed: coax + LV + HV, coax + LV + Fluidic, coax + LV + Fibre optic

	Reference	Coax					Low volt. (LV)		High volt. (HV)		Fibre optic (FO)		Fluidic (FL)		
		Number of contacts	Impedance ( $\Omega$ )	Rated current (A)	Type (see page 10)	Cable group	Number of contacts	$\phi$ A (mm)	Number of contacts	$\phi$ A (mm)	Number of contacts	Type	Number of contacts	Inner tube $\phi$ (mm)	
		<b>932</b>	1	50	2.0	C	1	2 <sup>1)</sup>	0.7	1 <sup>2)</sup>	0.7	-	-	-	-
			<b>934</b>	1	50	2.0	C	1	4	0.9	1	0.9	-	-	-
<b>970</b>	1		50	2.0	C	1	10	0.7	-	-	-	-	1	1.3	
<b>986</b>	1		50	2.0	C	1	16	0.7	-	-	1	F2	-	-	

**Note:** <sup>1)</sup> Test voltage LV contact-shell 1.9 (kV rms). <sup>2)</sup> Test voltage HV contact-shell 7.5 (kV rms). Total rated current for 2B.932 configuration 6 (A).

## Collet nut for fitting a bend relief (B and K series)

### D type collets for B series

	Clamping	Coax cable groupe		
		1	2	3
<b>B</b>	<b>D52Z</b>	D51Z	D52Z	D53Z
	<b>D62Z</b>	D61Z	D62Z	D63Z
	<b>D92Z</b>	D91Z	D92Z	D93Z
	<b>D10Z</b>	D01Z	D02Z	D03Z
	<b>D11Z</b>	D11Z	D12Z	D13Z
	<b>D12Z</b>	D21Z	D22Z	D23Z

### C type collets for K series

	Clamping	Coax cable groupe		
		1	2	3
<b>K</b>	<b>C50Z</b>	C51Z	C52Z	C53Z
	<b>C55Z</b>	C56Z	C57Z	C58Z
	<b>C80Z</b>	C81Z	C82Z	C83Z
	<b>C85Z</b>	C86Z	C87Z	C88Z
	<b>C90Z</b>	C91Z	C92Z	C93Z
	<b>C95Z</b>	C96Z	C97Z	C98Z
	<b>C10Z</b>	C01Z	C02Z	C03Z
	<b>C11Z</b>	C11Z	C12Z	C13Z
	<b>C12Z</b>	C21Z	C22Z	C23Z
	<b>C13Z</b>	C31Z	C32Z	C33Z
	<b>C14Z</b>	C41Z	C42Z	C43Z

**Note:** see unipole-multipole catalogue for others available collets.

## Coaxial contacts for B and K series

Type	Impedance ( $\Omega$ )	$\phi$ A (mm)	Cond. fixing	Screen fixing	Cable group	Mini Cond. $\phi$ maxi Maxi	Dielectric $\phi$ maxi	Sheath $\phi$		VSWR (f=GHz)	Test voltage (kV rms)	Rated current (A)
								Mini	Maxi			
<b>F</b> <sup>1) 3)</sup>	50	0.5	solder	crimp	2	0.35	1.05	–	2.10	1.05 +1.83f	0.8	2
<b>A1</b>	50	0.7	solder	collet	1	0.60	1.90	2.5	3.00	1.01 +0.127f	0.9	5
					2	0.60	1.90	1.7	2.10			
					3	0.60	1.90	2.2	2.60			
<b>C</b> <sup>1)</sup>	50	0.6	crimp	crimp	1	0.50 0.58	1.65	–	3.00	1.04 +0.1f	1.6	2
					2	0.28 0.35	1.05		2.35			
					3	0.28 0.35	1.65		3.00			
<b>E</b> <sup>1) 3)</sup>	50	0.5	solder	crimp	2	0.35	0.95	–	2.00	1.02 +0.93f	0.8	2
<b>A</b>	50	1.6	solder	collet	5	1.35	3.95	4.3	5.10	1.01 +0.146f	1.8	12
					6	1.35	3.95	5.3	6.10			
					75	1.3	solder	collet	4			
5	1.05	3.95	4.3	5.10								
6	1.05	3.95	5.3	6.10								
<b>A4</b>	75	1.3	solder	collet	none	1.05	3.95	6.7	7.60	1.01 +0.19f	2.4	7
<b>B</b> <sup>1)</sup>	50	0.9	solder	crimp	6	1.05	3.75	–	6.25	1.06 +0.156f	0.8	11
	75	0.6	solder	crimp	3	0.80	2.45	–	6.25	1.00 +0.22f	2.1	6
	5	0.80	3.75	–	6.25	1.00 +0.22f	2.1	6				
<b>B0</b>	75	0.6	solder	solder	1	0.75	2.95	–	4.25	1.00 +0.22f	2.1	6
	6	0.75	3.75	–	4.25	1.00 +0.22f	2.1	6				
<b>B1</b> <sup>1)</sup>	75	0.6	crimp	crimp	5	0.55 0.80	3.75	–	6.25	1.00 +0.22f	2.1	6
<b>D</b> <sup>1)</sup>	75	0.5	solder	crimp	5	0.75	3.75	–	5.40	1.00 +0.38f	1.0	5
					8	0.75	2.45		3.90			
					9	0.75	3.00		4.90			
<b>G</b> <sup>3)</sup>	50	0.5	solder	crimp	1	0.35	1.65	–	3.00	1.01 +0.73f	0.4	2
<b>A0</b>	50	1.3	solder	collet	6	0.95	–	3.3	4.10	1.02 +0.3f <sup>2)</sup>	3.0	12

**Note:**

<sup>1)</sup> These contacts require specific tools for assembly on the cable, see page 11.

<sup>2)</sup> Frequency range with SWR  $\leq$  1.2 = 0 - 1.5 GHz.

<sup>3)</sup> Coax contact design differs, the central pin is reverse gender.

## Recommended coaxial cables for mixed coax, multi coax for B and K Series

LEMO cable Part Number	Type	LEMO cable group	Impedance ( $\Omega$ )	Conductor $\varnothing$ (mm)	Dielectric $\varnothing$ (mm)	Screen $\varnothing$ (mm)	Sheath $\varnothing$ (mm)
	RG 6 A/U	7	75 $\pm$ 3	0.73	4.70	6.20	8.45
<b>311 100 LEDE</b>	RG 11 A/U	9	75 $\pm$ 2	1.17	7.25	8.15	10.10
<b>CCX.50.RG5.8CU50N</b>	RG 58 C/U	6	50 $\pm$ 2	0.90	2.95	3.60	5.00
<b>CCX.50.RG5.9BU62N</b>	RG 59 B/U	5	75 $\pm$ 3	0.60	3.70	4.50	6.20
<b>CCX.50.RG1.74AU27N</b>	RG 174 A/U	1	50 $\pm$ 2	0.48	1.50	2.00	2.80
<b>CCX.50.RG1.78BU18M</b>	RG 178 B/U	2	50 $\pm$ 2	0.30	0.84	1.30	1.80
<b>CCX.75.RG1.79BU26M</b>	RG 179 B/U	3	75 $\pm$ 3	0.30	1.50	2.00	2.50
	RG 180 B/U	4	95 $\pm$ 5 <sup>1)</sup>	0.30	2.60	3.10	3.60
<b>CCX.75.RG1.87AU26B</b>	RG 187 A/U	2	75 $\pm$ 3	0.30	1.50	2.00	2.60
<b>CCX.50.RG1.88AU26B</b>	RG 188 A/U	1	50 $\pm$ 2	0.54	1.50	2.00	2.60
<b>CCX.50.RG1.96AU20B</b>	RG 196 A/U	1	50 $\pm$ 2	0.30	0.84	1.30	1.95
<b>CCX.50.RG3.16U26M</b>	RG 316 /U	1	50 $\pm$ 2	0.60	1.60	2.10	2.80

**Note:** <sup>1)</sup> when no defined impedance is required.

The cable group number corresponding to the chosen cable must be written in the variant position, see pages 3 and 5.

## Tooling for coaxial contacts of B and K series

Coaxial contact type	Imp. $\Omega$	Cable group	Reference		
			Crimping tool with die	Spanner for tightening the contact	Extractor
F	50	2	<b>DPE.99.025.45K</b>	<b>DCC.91.019.1AK</b>	–
C <sup>1)</sup>	50	1-3	<b>DPE.99.103.8K</b>	–	<b>DCC.91.384.5LA</b>
	50	2	<b>DPE.99.103.1K</b>	–	<b>DCC.91.384.5LA</b>
E	50	2	<b>DPE.99.002.5K</b>	<b>DCC.91.050.2LA</b>	–
B	50	6	<b>DPE.99.176.2K</b>	–	<b>DCC.91.804.5LA</b>
	75	3	<b>DPE.99.125.2K</b>	–	<b>DCC.91.804.5LA</b>
	75	5	<b>DPE.99.127.0K</b>	–	<b>DCC.91.804.5LA</b>
B1	75	5	<b>DPE.99.127.0K</b>	–	<b>DCC.91.808.0LC</b>
D	75	5	<b>DPE.99.006.2K</b>	<b>DCB.91.685.8TN</b>	–
	75	8	<b>DPE.99.005.2K</b>	<b>DCB.91.685.8TN</b>	–
	75	9	<b>DPE.99.005.5K</b>	<b>DCB.91.685.8TN</b>	–

**Note:** <sup>1)</sup> for the 3B.243/3K.243 and 3B.862/3K.862 the extractor is part number DCC.91.393.4LT.

# 00.650 Series

The 00 Series are available in triax configuration, allowing a very compact solution for triaxial cables.

These connectors are designed for small diameter ranging from 1.1 to 3.5 mm.

Either twinax (2 shielded connectors) or triax (1 conductor and 2 concentric separate screens) can be used with the 00 Series. The 00 Series with a 650 configuration insert are mostly used in audio-video applications where a large density of connection is required.

LEMO 00 Series connectors offer customers many benefits including:

- self-latching push-pull system
- aesthetically pleasing appearance
- small size
- high packing density
- rugged construction.
- ease of use
- low weight
- reliable performances
- wide choice to suit application

## Metal housing models

### Elbow plug

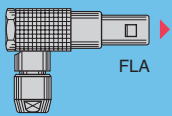

FLA

### Straight plugs

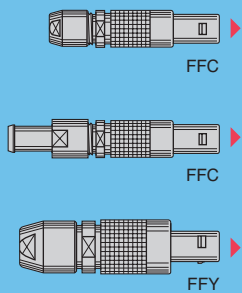

FFC

FFC

FFY

### Fixed and free sockets

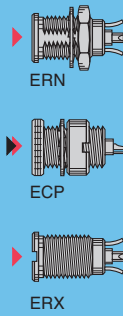

ERN

ECP

ERX

### Free socket



PCA

### Elbow socket

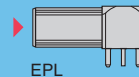

EPL

### Fixed socket

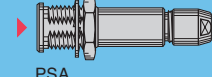

PSA

## Plastic housing model

### Straight plug

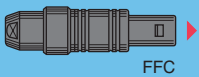

FFC

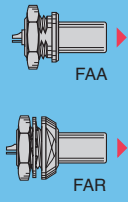

FAA

FAR

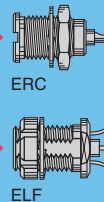

ERC

ELF

## Threaded latching models

### Straight plug

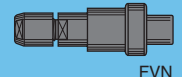

FVN

### Fixed socket



ELF

## Model Description

**ECP** Fixed socket with 2 round nuts (back panel mounting)

**ELF** Fixed socket, nut fixing, threaded shell with tag (back panel mounting)

**ELF** Fixed socket, nut fixing, threaded shell with tag, black chromium-plated outer shell (back panel mounting)

**EPA** Straight socket for printed circuit board

**EPL** Elbow plug (90°) for printed circuit board

**ERC** Fixed socket, with thread, with slots in flange

**ERN** Fixed socket with nut fixing and tags

**ERX** Fixed socket with nut fixing, slots on flange and tags

**FAA** Straight plug non latching with nut

**FAR** Straight plug non latching with 2 nuts (back panel mounting)

**FFC** Straight plug with flats on latch sleeve and cable collet

**FFC** Straight plug with flats on latch sleeve and cable collet and nut for fitting a bend relief

**FFC** Straight plug with flats on latch sleeve and cable collet, black POM (Delrin®) outershell)

**FFY** Straight plug, large shell with cable collet

**FLA** Elbow socket (90°) with cable collet

**FVN** Straight plug with cable collet, black chromium-plated outer shell

**PCA** Free socket with cable collet

**PSA** Fixed socket, nut fixing, cable collet

## Part Section Showing Internal Components

### Fixed socket

- 1 outer shell
- 2 earthing crown
- 3 retaining ring
- 4 hexagonal nut
- 5 locking washer
- 6 insulator
- 7 female triaxial contact

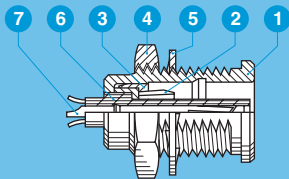

### Straight plug

- 1 outer shell
- 2 latch sleeve
- 3 collet nut
- 4 earthing sleeve
- 5 rear insulator
- 6 insulator
- 7 male triaxial contact
- 8 collet

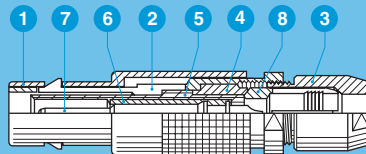

## Part Numbering System

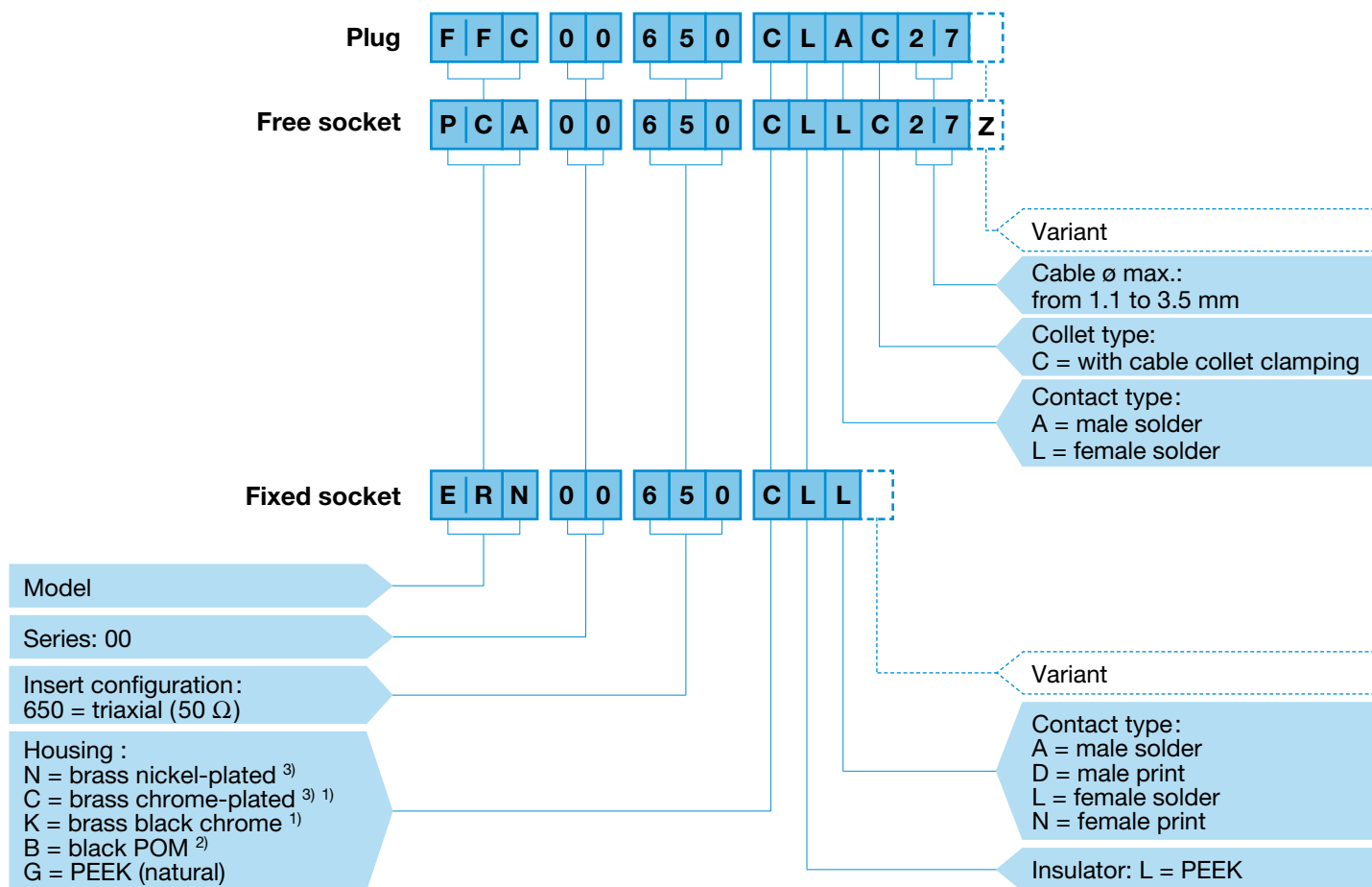

**FFC.00.650.CLAC27** = straight plug with flats on latch sleeve and cable collet, 00 Series, triaxial (50  $\Omega$ ), outer shell in chrome-plated brass, PEEK insulator, C type collet for an up to 2.6 mm diameter cable.

**PCA.00.650.CLLC27Z** = free socket with cable collet, 00 Series, triaxial (50  $\Omega$ ), outer shell in chrome-plated brass, PEEK insulator, C type collet for an up to 2.6 mm diameter cable and nut for fitting a bend relief.

**ERN.00.650.CLL** = fixed socket with nut fixing and tags, 00 Series, triaxial (50  $\Omega$ ), outer shell in chrome-plated brass, PEEK insulator.

**Note:** <sup>1)</sup> treatment not available for the printed circuit models. <sup>2)</sup> available for the FFC model only. <sup>3)</sup> standard.

## Insert configuration

	Reference	Series		Impedance ( $\Omega$ )	$\phi$ A (mm)	Cable group	Cond. $\phi$ max	Dielectric $\phi$ maxi	Sheath $\phi$ maxi	VSWR (f=GHz)	Test voltage (kV rms)	Rated current (A)
		Standard	Watertight									
	<b>650</b>	00	-	50	0.5	<sup>1)</sup>	0.55	2.9	3.5	1.02 +0.9f	0.6	4

**Note:** <sup>1)</sup> 00.650 is designed for use with 2 conductors screened cable (twinax).

# S Series

S series connectors have main features as follows:

- security of the Push-Pull self-latching system
- solder contacts, print contacts only for coaxial and triaxial configurations
- 360° screening for full EMC shielding.

- coaxial, triaxial and mixed contact configurations
- polarisation by stepped insert (half-moon)
- up to 8 coaxial contacts

## Metal housing models

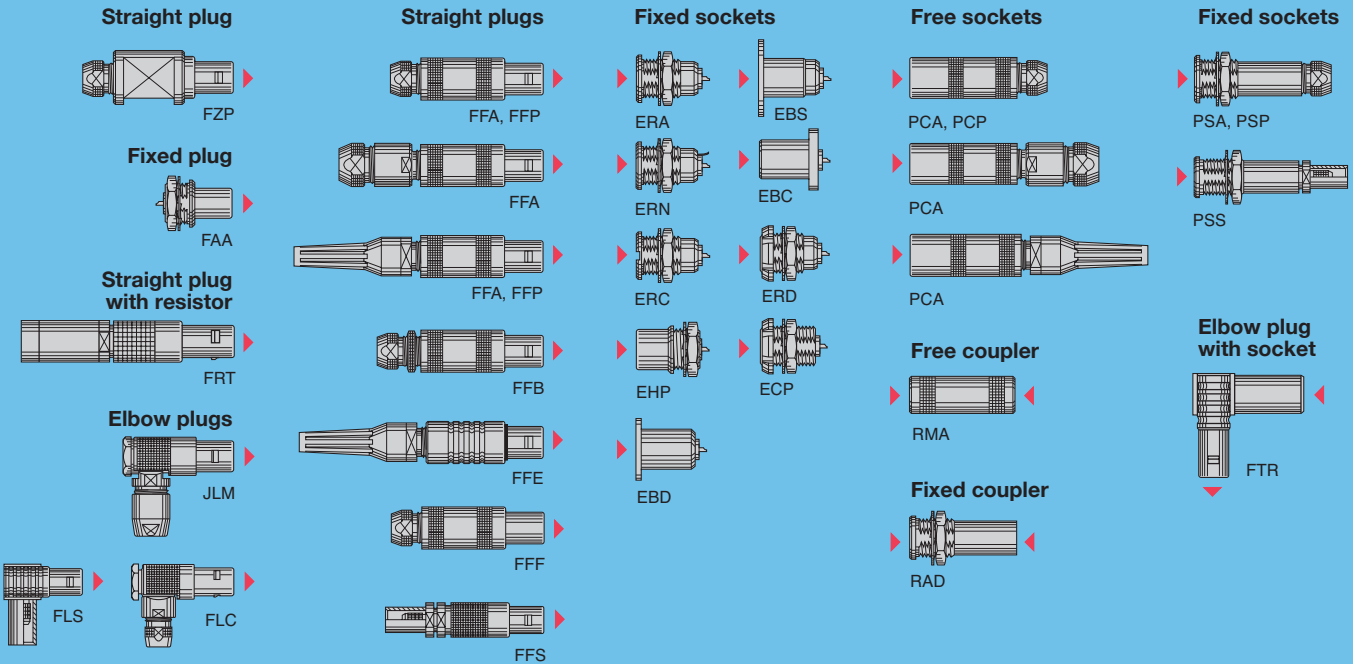

## Plastic housing models

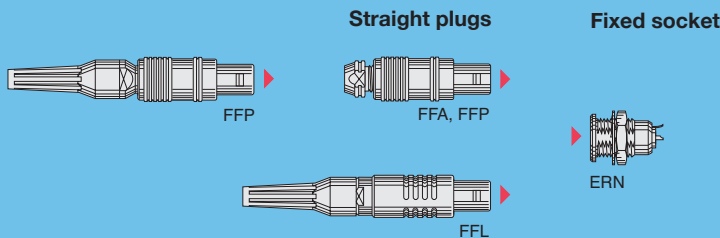

## Watertight or vacuumtight models

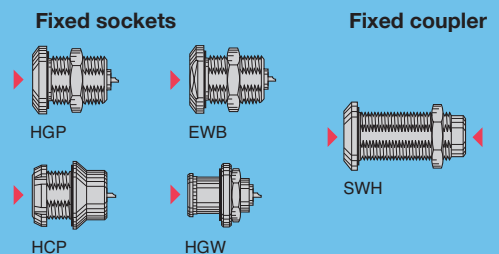

## Model Description

- EBC** Fixed socket with square flange, protruding shell and screw fixing
- EBD** Fixed socket with square flange, screw fixing
- EBS** Fixed socket with round flange, screw fixing
- ECP** Fixed socket with two nuts, long threaded shell (back panel mounting)
- EHP** Fixed socket, nut fixing, protruding shell
- ERA** Fixed socket, nut fixing
- ERC** Fixed socket, nut fixing, slot in the flange
- ERD** Fixed socket with two nuts (back panel mounting)
- ERN** Fixed socket, nut fixing, with earthing tag
- ERN** Fixed socket, nut fixing, with earthing tag, PEEK or POM outer shell
- EWB** Fixed socket, nut fixing, with two flats on the flange, watertight or vacuumtight
- FAA** Fixed plug non-latching, nut fixing
- FFA** Straight plug, cable collet
- FFA** Straight plug with oversize cable collet
- FFA** Straight plug, cable collet and nut for fitting a bend relief
- FFA** Straight plug, cable collet, PEEK or POM outer shell
- FFB** Straight plug, cable collet and safety locking ring
- FFE** Straight plug, cable collet, PEEK or POM outer shell and nut for fitting a bend relief (protected to IP54 when mated)
- FFF** Straight plug, non-latching, cable collet
- FFP** Straight plug, cable collet and inner anti-rotating device
- FFP** Straight plug, cable collet, PEEK or POM outer shell and inner anti-rotating device
- FFP** Straight plug, cable collet, PEEK or POM outer shell, inner anti-rotating device and nut for fitting a bend relief
- FFS** Straight plug for cable crimping
- FLC** Elbow (90°) plug, cable collet
- FLC** Elbow (90°) plug, cable collet and nut for fitting a bend relief
- FLS** Elbow (90°) plug for cable crimping
- FRT** Straight plug with resistor
- FTR** Elbow (90°) plug with socket
- FZP** Straight plug for remote handling, cable collet and inner anti-rotating device
- HCP** Fixed socket, nut fixing, watertight or vacuumtight (back panel mounting)
- HGP** Fixed socket, nut fixing, watertight or vacuumtight
- HGW** Fixed socket, nut fixing, with back washer, watertight or vacuumtight
- JLM** Elbow (90°) plug, cable collet
- PCA** Free socket, cable collet
- PCA** Free socket with oversize cable collet
- PCA** Free socket, cable collet and nut for fitting a bend relief
- PCP** Free socket, cable collet and inner anti-rotating device
- PSA** Fixed socket, nut fixing, cable collet
- PSP** Fixed socket, nut fixing, cable collet and inner anti-rotating device
- PSS** Free socket, nut fixing for cable crimping
- RAD** Fixed coupler, nut fixing
- RMA** Free coupler
- SWH** Fixed coupler, nut fixing, watertight or vacuumtight



## Part Numbering System

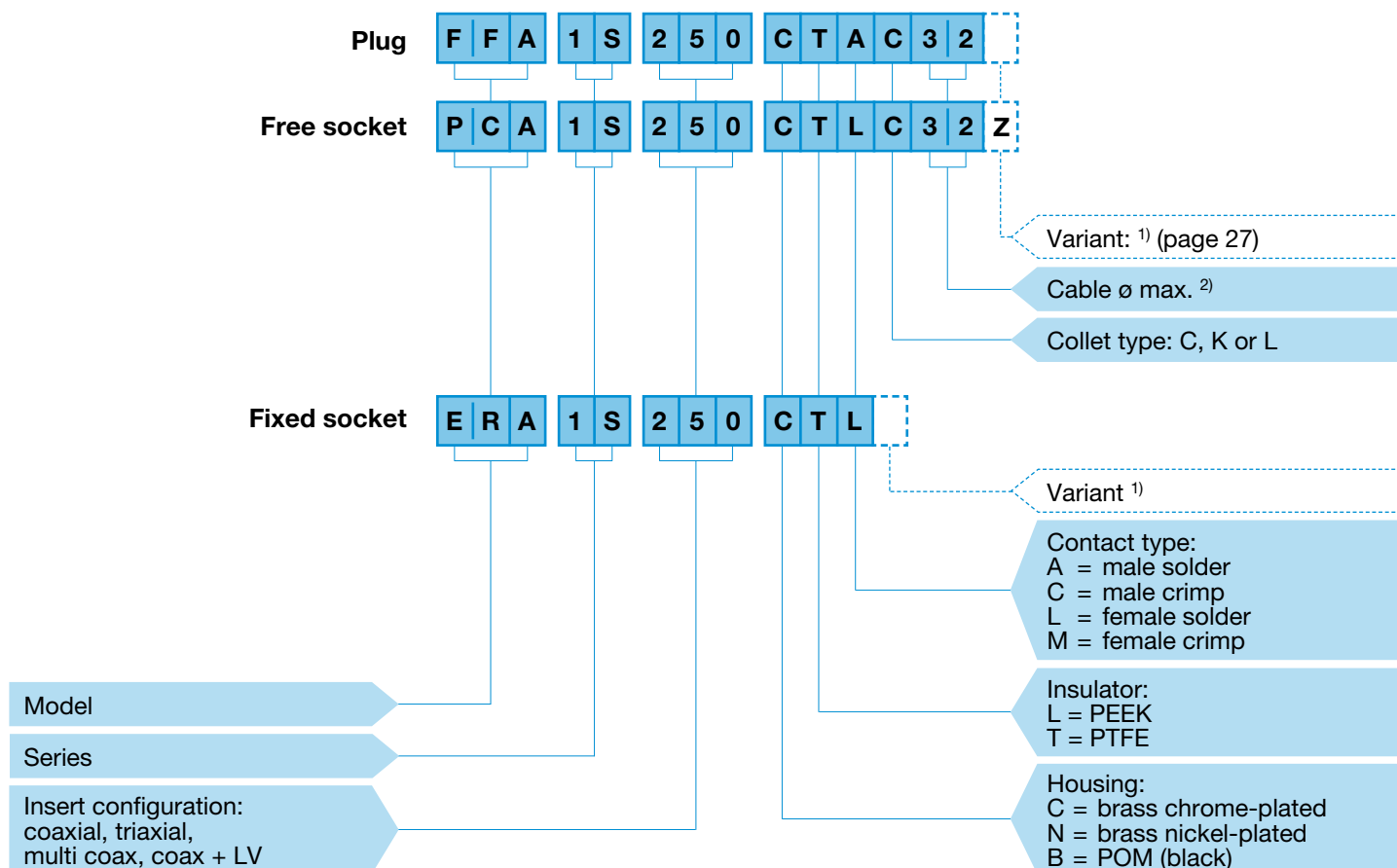

**FFA.1S.250.CTAC32** = straight plug with cable collet, 1S series, coaxial (50 Ω), outer shell in chrome-plated brass, PTFE insulator, male solder contact, C type collet for a 3.2 mm diameter cable.

**PCA.1S.250.CTLC32Z** = free socket with cable collet, 1S series, coaxial (50 Ω), outer shell in chrome-plated brass, PTFE insulator, female solder contact, C type collet for a 3.2 mm diameter cable and nut for fitting a bend relief.

**ERA.1S.250.CTL** = fixed socket, nut fixing, 1S series, coaxial (50 Ω), outer shell in chrome-plated brass, PTFE insulator, female solder contact.

**Note:** <sup>1)</sup> for mixed contacts, add cable group to the part number.  
<sup>2)</sup> see unipole-multipole catalogue.

## Part Section Showing Internal Components (mixed coax + LV)

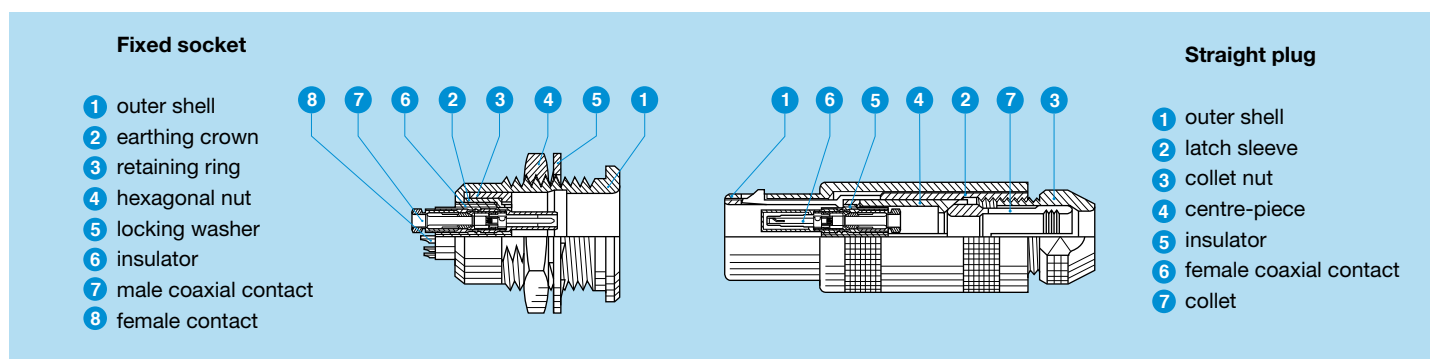

# E Series

E series connectors have been specifically designed for outdoor applications.

They include an inner sleeve and two seals to prevent penetration of solids or liquids into the housing formed by the plug, free socket or fixed socket. All models of these series are watertight when mated and give a protection index of IP 68 as per IEC 60529 standard (in mated condition) when correctly assembled to an appropriate cable (IP 66 otherwise).

- security of the Push-Pull latching system
- watertight connection (IP 68/IP 66)
- solder contacts, print contacts only for coaxial and triaxial configurations
- coaxial, triaxial and mixed contact configurations
- polarization by stepped insert (half-moon)
- 360° screening for full EMC shielding
- rugged housing for extreme working condition.

## Models

### Straight plug

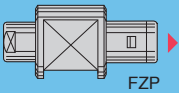

FZP

### Fixed plug

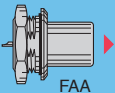

FAA

### Elbow plug

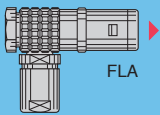

FLA

### Straight plugs

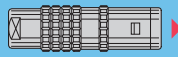

FFA

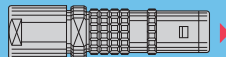

FFA

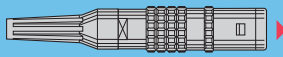

FFA

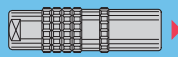

FFF

### Fixed sockets

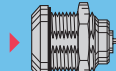

ERA



ERB

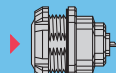

EEP

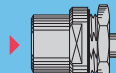

EHP

### Free sockets

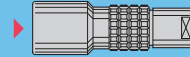

PCA

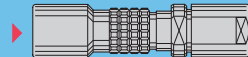

PCA

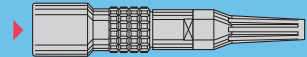

PCA

### Fixed socket

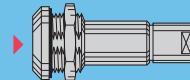

PSA

## Watertight or vacuumtight models

### Fixed sockets

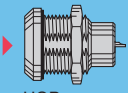

HGP

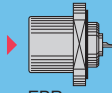

EBR

### Fixed coupler

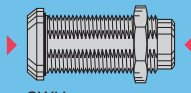

SWH

### Free coupler

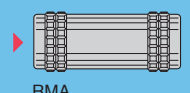

RMA

## Model Description

- EBR** Fixed socket with round flange, watertight, protruding shell and screw fixing
- EEP** Fixed socket, nut fixing (back panel mounting)
- EHP** Fixed socket, nut fixing, protruding shell
- ERA** Fixed socket, nut fixing
- ERB** Fixed socket, nut fixing with two flats in the flange
- FAA** Fixed plug non-latching, nut fixing
- FFA** Straight plug, cable collet

- FFA** Straight plug with oversize cable collet
- FFA** Straight plug, cable collet and nut for fitting a bend relief
- FFF** Straight plug non-latching, cable collet
- FLA** Elbow (90°) plug, cable collet
- FZP** Straight plug for remote handling, cable collet and inner anti-rotating device
- HGP** Fixed socket, nut fixing, watertight or vacuumtight
- PCA** Free socket, cable collet

- PCA** Free socket with oversize cable collet
- PCA** Free socket, cable collet and nut for fitting a bend relief
- PSA** Fixed socket, nut fixing, cable collet
- RMA** Free coupler
- SWH** Fixed coupler, nut fixing, watertight or vacuumtight

## Part Numbering System

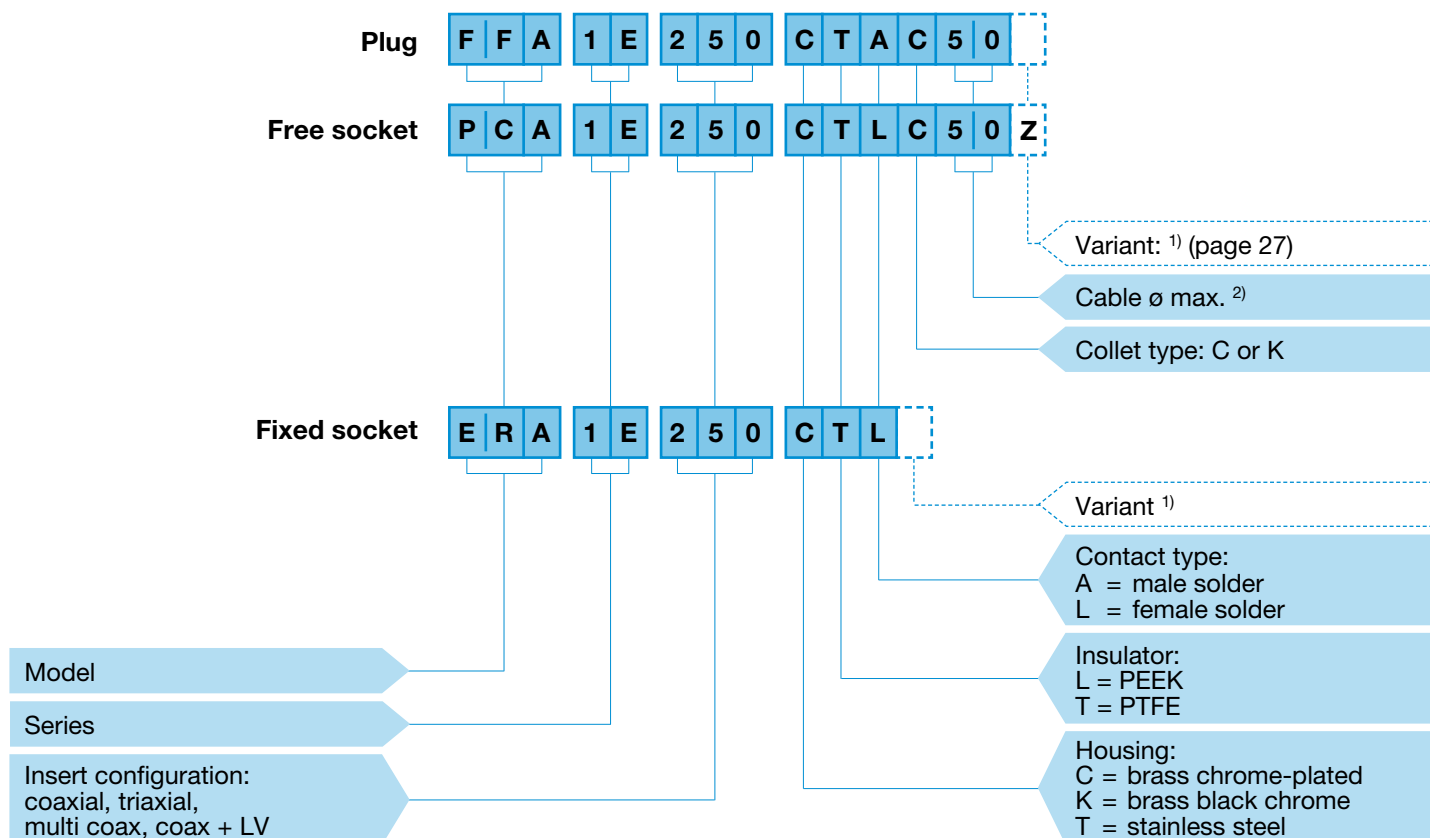

**FFA.1E.250.CTAC50** = straight plug with cable collet, 1E series, coaxial (50  $\Omega$ ), outer shell in chrome-plated brass, PTFE insulator, C type collet for an up to 5.0 mm diameter cable.

**PCA.1E.250.CTLC50Z** = free socket with cable collet, 1E series, coaxial (50  $\Omega$ ), outer shell in chrome-plated brass, PTFE insulator, C type collet for an up to 5.0 mm diameter cable and collet nut for fitting a bend relief.

**ERA.1E.250.CTL** = fixed socket, nut fixing, 1E series, coaxial (50  $\Omega$ ), outer shell in chrome-plated brass, PTFE insulator.

**Note:** <sup>1)</sup> for mixed contacts, add cable group to the part number.  
<sup>2)</sup> see unipole-multipole catalogue.

## Part Section Showing Internal Components (mixed coax + LV)

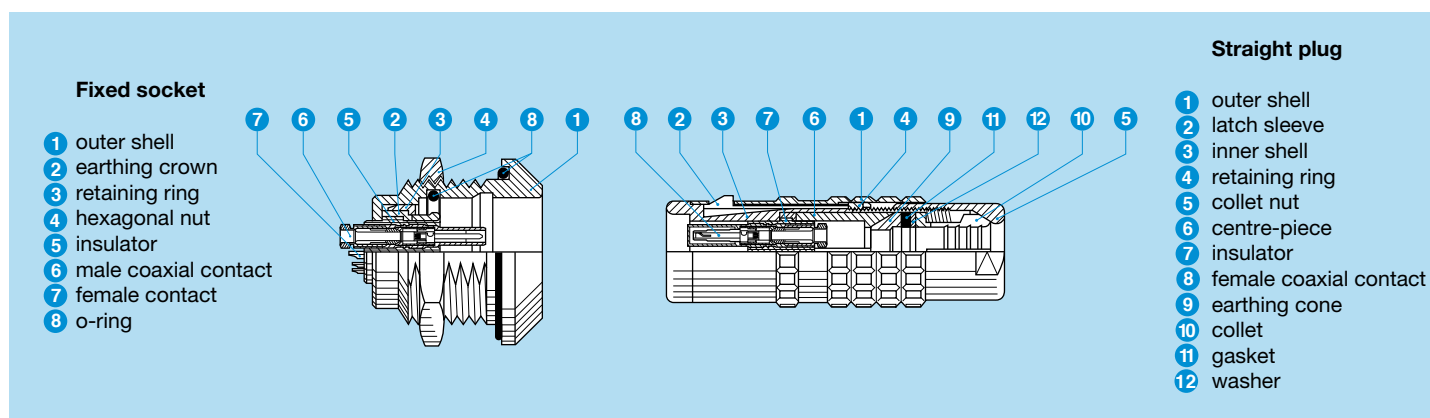

## Insert configuration (S and E series)

### Coaxial

			Reference	Series		Impedance (Ω)	ø A (mm)	Cable group	Cond. ø max	Dielectric ø maxi	Sheath ø		VSWR (f=GHz)	Test voltage (kV rms)	Rated current (A)
				Standard	Watertight						Maxi S series	Maxi E series			
<b>00</b>			<b>250<sup>1)</sup></b>	00	-	50	0.7	1 to 9	1.05	3.05	5.5		1.09 +0.11f	2.1	4
<b>0S 0E</b>			<b>250</b>	0S	0E	50	0.9	1-2 3-4	0.95	2.95	6.7	5.0	1.02 +0.25f	3.0	6
<b>1S 1E</b>			<b>250</b>	1S	1E	50	1.6	1-2 3-4	1.35	3.95	8.5	8.5	1.01 +0.23f	3.0	12
			<b>275</b>	1S	1E	75	1.3	5-6-7	1.05	3.95	8.5	8.5	1.02 +0.08f	2.4	10
<b>2S 2E</b>			<b>250</b>	2S	2E	50	2.0	6-7	1.75	5.95	10.5	10.5	1.01 +0.95f	3.0	15
			<b>275</b>	2S	2E	75	1.6	6-7	1.35	5.95	10.5	10.5	1.02 +0.03f	1.5	12
<b>3S 3E</b>			<b>250</b>	3S	3E	50	3.0	8	2.65	8.15	13.0	15.0	1.06 +0.5f	3.0	26
			<b>275</b>	3S	3E	75	2.0	8	1.75	8.15	13.0	15.0	1.04 +0.05f	2.7	15
<b>4S 4E</b>			<b>250</b>	4S	4E	50	4.0	8-9	3.65	10.05	22.0	23.5	1.01 +1.9f	2.1	36
			<b>275</b>	4S	4E	75	3.0	8-9-0	2.65	10.05	22.0	23.5	1.01 +0.12f	1.8	26
<b>5S</b>			<b>250</b>	5S	-	50	5.0	9	5.15	17.45	30.0	30.0	1.02 +2.3f	3.0	45

Note: <sup>1)</sup> see NIM-CAMAC catalogue.

## Triaxial

			Reference	Series		Impedance (Ω)	ø A (mm)	Cable group	Cond. ø max	Dielectric ø maxi	Sheath ø		VSWR (f=GHz)	Test voltage (kV rms) (contact/screen)	Rated current (A)
				Standard	Watertight						Maxi S series	Maxi E series			
<b>0S 0E</b>			<b>650</b>	0S	0E	50	0.9	1-2	0.75	2.95	6.7	5.0	1.03 +0.34f	1.0	6
			<b>1S 1E</b>	1S	1E	50	0.9	1-2-3	0.75	3.95	8.5	8.5	1.01 +0.17f	1.0	6
<b>2S 2E</b>			<b>650</b>	2S	2E	50	1.6	2-3-4	1.35	5.95	10.5	10.5	1.01 +0.3f	1.5	12
			<b>675</b>	2S	2E	75	0.9	4-6	0.75	5.95	10.5	10.5	1.01 +0.07f	1.5	6
<b>3S 3E</b>			<b>650</b>	3S	3E	50	2.0	3-4-5	1.75	8.45	13.0	15.0	1.01 +0.27f	2.4	15
			<b>675</b>	3S	3E	75	0.9	4-5	0.75	8.45	13.0	15.0	1.01 +0.05f	1.8	6
<b>4S 4E</b>			<b>650</b>	4S	4E	50	3.0	4-5	2.65	10.05	22.0	23.5	1.01 +0.38f	2.7	26
			<b>675</b>	4S	4E	75	2.0	4-5-7	2.25	10.05	22.0	23.5	1.01 +0.14f	2.2	15

## Mixed: coax + LV, multi coax

		Reference	Series		Coaxial				Low voltage					
			Standard	Watertight	Number of contacts	Impedance ( $\Omega$ )	Rated current (A)	Type (see page 27)	Cable group	Number of contacts	$\phi$ A (mm)	Test voltage (kV rms)	Test voltage (kV dc)	Rated current (A)
<b>3S</b> <b>3E</b>		<b>801</b>	3S	3E	1	50	5	A1	1-2-3	1	1.3	2.7	3.9	14
		<b>802</b>	3S	3E	1	50	5	A1	1-2-3	2	1.3	1.2	1.8	14
		<b>803</b>	3S	3E	1	50	5	A1	1-2-3	3	1.3	2.7	3.9	14
		<b>804</b>	3S	3E	1	50	5	A1	1-2-3	4	1.3	1.2	1.8	10
		<b>805</b>	3S	3E	1	50	5	A1	1-2-3	5	0.9	1.8	2.4	8
		<b>806</b>	3S	3E	1	50	5	A1	1-2-3	6	0.9	0.8	1.2	8
		<b>807</b>	3S	3E	1	50	5	A1	1-2-3	7	0.9	0.8	1.2	7
<b>4S</b> <b>4E</b>		<b>802</b>	4S	4E	1	50	5	A1	1-2-3	2	3.0	2.1	3.0	21
		<b>803</b>	4S	4E	1	50	5	A1	1-2-3	3	2.0	2.1	3.0	16
		<b>804</b>	4S	4E	1	50	5	A1	1-2-3	4	1.3	2.7	3.9	13
		<b>805</b>	4S	4E	1	50	5	A1	1-2-3	5	1.3	2.1	3.0	11
		<b>806</b>	4S	4E	1	50	5	A1	1-2-3	6	1.3	2.1	3.0	9
		<b>807</b>	4S	4E	1	50	5	A1	1-2-3	7	1.3	2.1	3.0	8
		<b>809</b>	4S	4E	1	50	5	A1	1-2-3	9	0.9	2.1	3.0	7
		<b>810</b>	4S	4E	1	50	5	A1	1-2-3	10	0.9	2.1	3.0	7
		<b>812</b>	4S	4E	1	50	5	A1	1-2-3	12	0.9	2.1	3.0	7
		<b>202</b>	4S	4E	2	50	5	A1	1-2-3	-	-	-	-	-
		<b>832</b>	4S	4E	2	50	5	A1	1-2-3	2	1.3	2.1	3.0	13

### Mixed: coax + LV, multi coax

		Reference	Series		Coaxial				Low voltage						
			Standard	Watertight	Number of contacts	Impedance ( $\Omega$ )	Rated current (A)	Type (see page 27)	Cable group	Number of contacts	$\phi$ A (mm)	Test voltage (kV rms)	Test voltage (kV dc)	Rated current (A)	
			<b>834</b>	4S	4E	2	50	5	A1	1-2-3	4	1.3	2.1	3.0	13
			<b>836</b>	4S	4E	2	50	5	A1	1-2-3	6	0.9	1.8	2.4	7
			<b>838</b>	4S	4E	2	50	5	A1	1-2-3	8	0.9	1.8	2.4	7
			<b>842</b>	4S	4E	2	50	5	A1	1-2-3	12	0.9	1.8	2.4	7
		<b>803</b>	-	5E	1	50	12	A	4-6	3	3.0	3.0	4.2	25	
		<b>804</b>	5S	-	1	50	6	A0	1-3-4	4	3.0	2.1	3.0	22	
		<b>804</b>	-	5E	1	75	7	A	3-4-5	4	3.0	2.1	3.0	22	
		<b>810</b>	5S	5E	1	50	5	A1	1-2-3	10	1.6	1.8	2.4	11	
		<b>232</b>	5S	-	2	50	6	A0	1-3-4	-	-	-	-	-	
		<b>282</b> <b>292</b>	5S	5E	2	50 75	12 7	A	4-6 3-4-5	-	-	-	-	-	
		<b>832</b>	5S	5E	2	50	6	A0	1-3-4	2	2.0	2.1	3.0	18	

## Mixed: coax + LV, multi coax

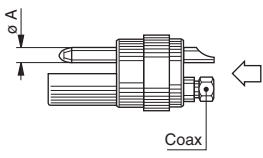
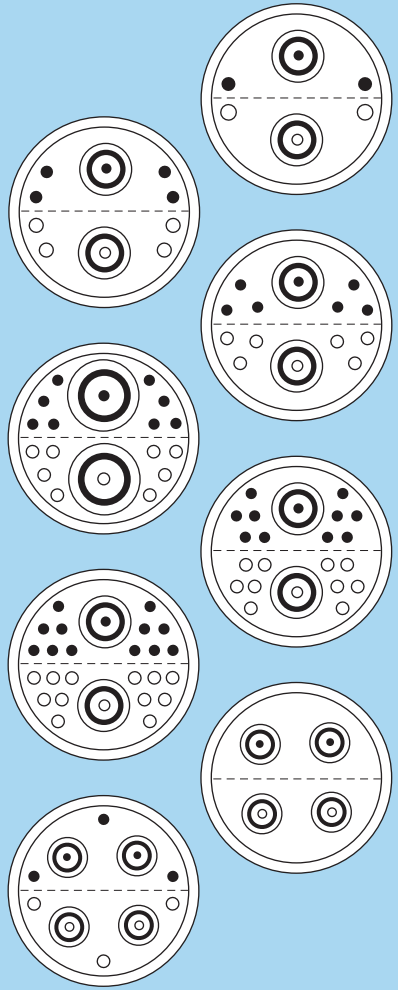
	Reference	Series		Coaxial				Low voltage					
		Standard	Watertight	Number of contacts	Impedance ( $\Omega$ )	Rated current (A)	Type (see page 27)	Cable group	Number of contacts	$\phi$ A (mm)	Test voltage (kV rms)	Test voltage (kV dc)	Rated current (A)
<div style="border: 1px solid black; padding: 2px; display: inline-block; margin-bottom: 5px;">5S 5E</div>  	<b>834</b>	5S	5E	2	50	6	A0	1-3-4	4	2.0	2.1	3.0	18
	<b>838</b>	5S	-	2	50	6	A0	1-3-4	8	1.6	1.8	2.4	12
	<b>842</b>	5S	5E	2	50	6	A0	1-3-4	12	1.3	1.8	2.4	9
	<b>846</b>	-	5E	2	75	7	A	3-4-5	16	1.3	0.8	1.2	8
	<b>850</b>	5S	-	2	50	6	A0	1-3-4	20	1.3	0.8	1.2	7
	<b>854</b>	5S	-	2	50	6	A0	1-3-4	24	1.3	0.8	1.2	6
	<b>234</b>	5S	5E	4	50	5	A1	1-2-3	-	-	-	-	-
	<b>876</b>	5S	5E	4	50	5	A1	1-2-3	6	1.3	0.8	1.2	6

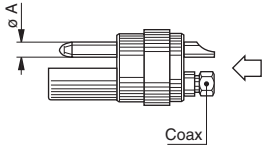
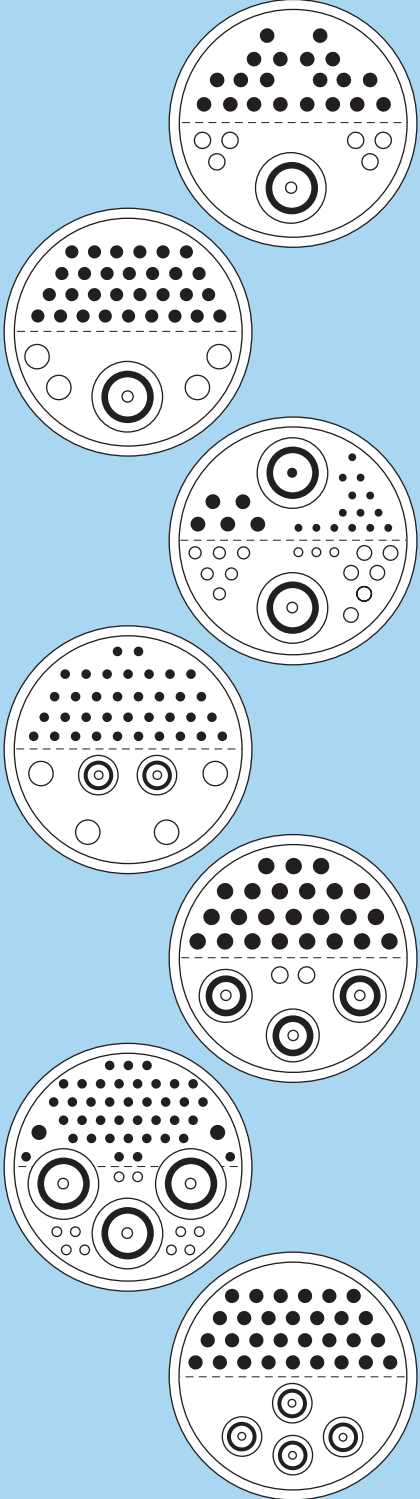

### Mixed: coax + LV, multi coax

	Reference	Coaxial					Low voltage				
		Number of contacts	Impedance ( $\Omega$ )	Rated current (A)	Type (see page 27)	Cable group	Number of contacts	$\phi$ A (mm)	Test voltage (kV rms)	Test voltage (kV dc)	Rated current (A)
<div style="border: 1px solid black; padding: 2px; display: inline-block; margin-bottom: 10px;">6S</div>  	826	1	75	7	A	3-4-5	26	2.0	1.5	2.1	7
	830	1	75	7	A	3-4-5	4 30	3.0 1.6	1.5 1.5	2.1 2.1	14 5
	858	2	75	7	A	3-4-5	6 6 5 17	1.3 1.6 2.0 1.9	1.2 1.2 1.2 1.2	1.8 1.8 1.8 1.8	4 5 10 2
	859	2	50	5	A1	1-2-3	36 4	1.3 3.0	1.2 1.2	1.8 1.8	4 14
	866	3	50	6	A0	1-3-4	26	2.0	1.5	2.1	7
	867	3	75	7	A	3-4-5	49 2	0.9 1.6	1.2 1.2	1.8 1.8	2 5
	883	4	50	4	A1	1-2-3	30	1.6	1.5	2.1	5

### Mixed: coax + LV, multi coax

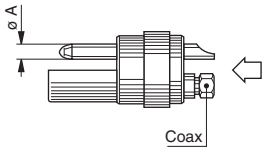
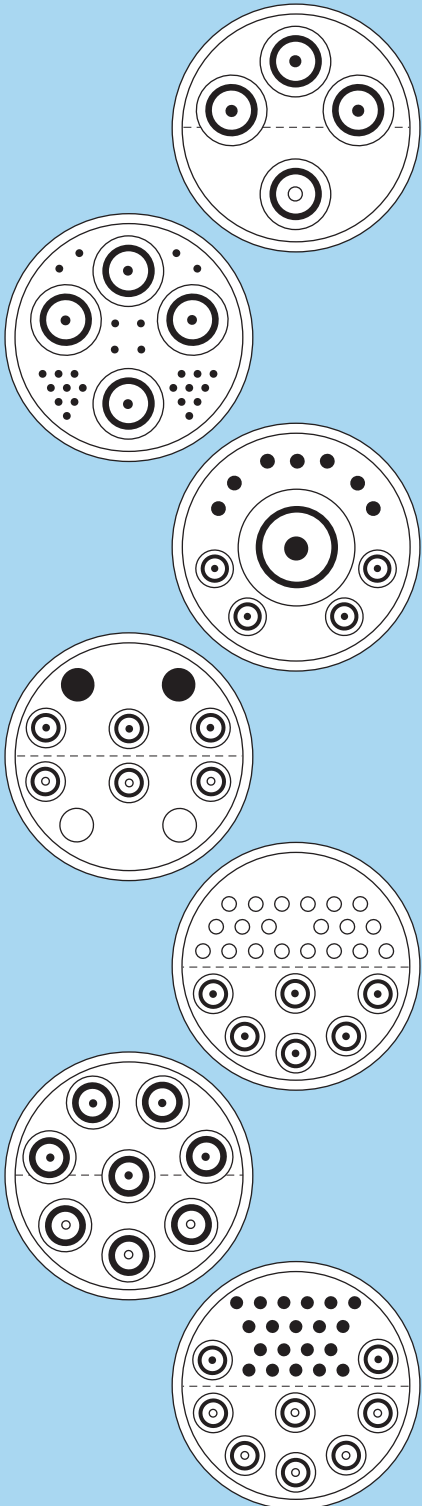
	Reference	Coaxial					Low voltage				
		Number of contacts	Impedance (Ω)	Rated current (A)	Type (see page 27)	Cable group	Number of contacts	ø A (mm)	Test voltage (kV rms)	Test voltage (kV dc)	Rated current (A)
<div style="border: 1px solid black; padding: 2px; width: fit-content; margin-bottom: 10px;">6S</div>  	284 294	4	50 75	12 7	A	4-6 3-4-5	-	-	-	-	
	882	4	75	7	A	3-4-5	26	0.9	0.8	1.2	2
	887	1 4	50 50	26 5	A3 A1	7 3 } 9	7	2.0	1.5	2.1	10
	890	6	50	5	A1	1-2-3	4	4.0	1.5	2.1	16
	893	6	50	5	A1	1-2-3	20	1.6	1.5	2.1	5
	238	8	50	6	A0	1-3-4	-	-	-	-	-
	899	8	50	5	A1	1-2-3	20	1.6	1.5	2.1	5

## Mixed: coax + LV, multi coax

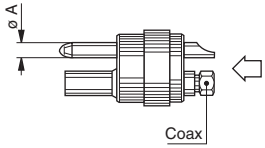
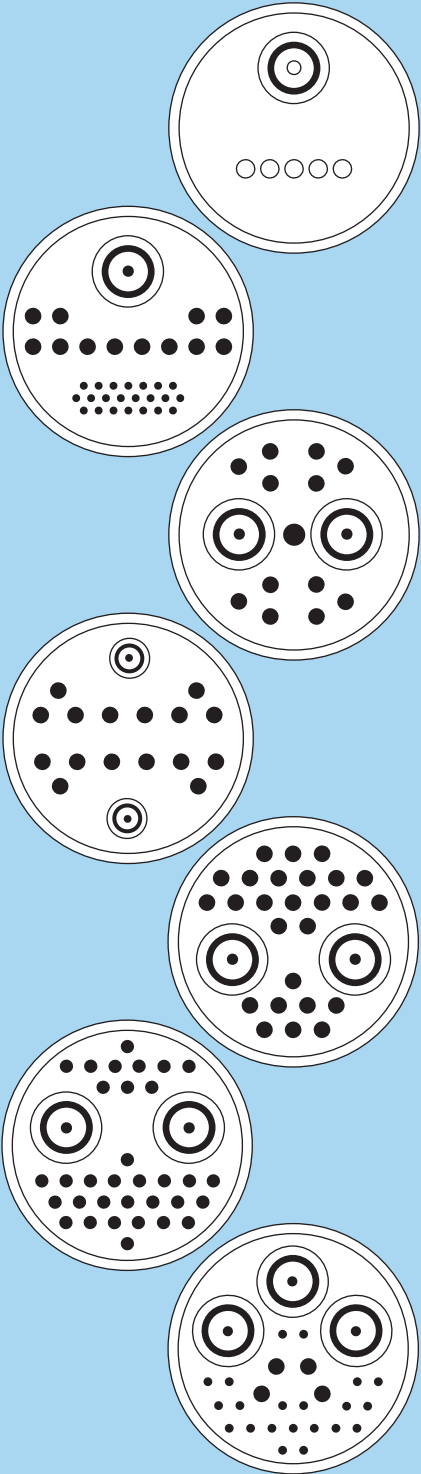
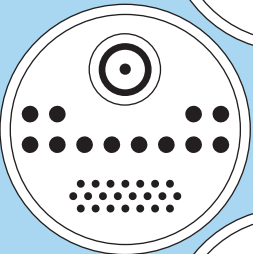
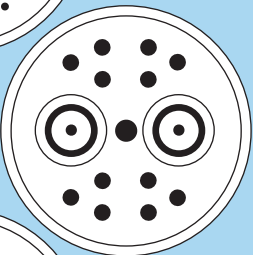
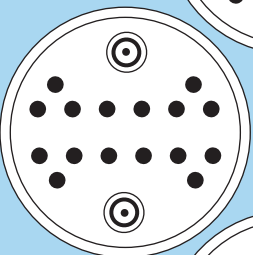
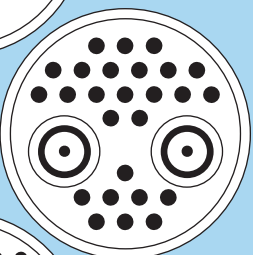
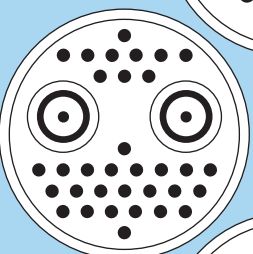
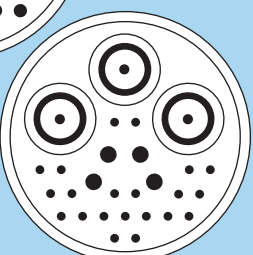
	Reference	Coaxial					Low voltage				
		Number of contacts	Impedance ( $\Omega$ )	Rated current (A)	Type (see page 27)	Cable group	Number of contacts	$\phi$ A (mm)	Test voltage (kV rms)	Test voltage (kV dc)	Rated current (A)
<div style="border: 1px solid black; padding: 2px; display: inline-block; margin-bottom: 10px;"><b>6E</b></div>        	<b>805<sup>1)</sup></b>	1	75	7	A	3-4-5	5	2.0	1.5	2.1	10
	<b>831</b>	1	75	7	A	3-4-5	24 12	0.9 2.0	0.8 1.5	1.2 2.1	2 10
	<b>843</b>	2	75	7	A	3-4-5	12 1	2.0 3.0	1.5 1.5	2.1 2.1	10 14
	<b>847</b>	2	50	5	A1	1-2-3	17	2.0	1.5	2.1	10
	<b>856</b>	2	75	7	A	3-4-5	26	2.0	1.5	2.1	7
	<b>857</b>	2	75	7	A	3-4-5	33	1.3	1.2	1.8	4
	<b>865</b>	3	75	7	A	3-4-5	21 4	1.3 2.0	1.2 1.2	1.8 1.8	4 10

**Note:** <sup>1)</sup> The type 6E.805 is delivered with female contacts in the plug.

## Mixed: coax + LV, multi coax

	Reference	Coaxial					Low voltage				
		Number of contacts	Impedance ( $\Omega$ )	Rated current (A)	Type (see page 27)	Cable group	Number of contacts	$\phi$ A (mm)	Test voltage (kV rms)	Test voltage (kV dc)	Rated current (A)
<div style="border: 1px solid black; padding: 2px; width: fit-content; margin-bottom: 10px;">6E</div>	866	3	75	7	A	3-4-5	26	1.3	1.2	1.8	4
	880	4	50	5	A1	1-2-3	20	1.3	1.2	1.8	4
	882	4	75	7	A	3-4-5	20	0.9	0.8	1.2	2
	884	4	75	7	A	3-4-5	38	0.9	0.8	1.2	2
	235	5	50	6	A0	1-3-4	-	-	-	-	-
	899	8	50	5	A1	1-2-3	20	1.6	1.5	2.1	5

## Mixed: coax + LV + HV

	Reference	Coax					Low voltage (LV)		High voltage (HV)		
		Number of contacts	Impedance ( $\Omega$ )	Rated current (A)	Type (see page 27)	Cable group	Number of contacts	$\phi A$ (mm)	Number of contacts	$\phi A$ (mm)	
<b>4S</b> <b>4E</b>		<b>934</b>	1	50	5	A1	1-2-3	4	0.9	1	2.0

## Collet nut for fitting a bend relief (S and E series)

### C type collets for S series

	Clamping	Coax cable groupe		
		1	2	3
<b>S</b>	<b>C42Z</b>	C41Z	C42Z	C43Z
	<b>C57Z</b>	C51Z	C52Z	C53Z
	<b>C72Z</b>	C71Z	C72Z	C73Z
	<b>C87Z</b>	C81Z	C82Z	C83Z
	<b>C97Z</b>	C91Z	C92Z	C93Z
	<b>C11Z</b>	C11Z	C12Z	C13Z
	<b>C12Z</b>	C21Z	C22Z	C23Z

### C type collets for E series

	Clamping	Coax cable groupe		
		1	2	3
<b>E</b>	<b>C50Z</b>	C51Z	C52Z	C53Z
	<b>C55Z</b>	C56Z	C57Z	C58Z
	<b>C80Z</b>	C81Z	C82Z	C83Z
	<b>C85Z</b>	C86Z	C87Z	C88Z
	<b>C90Z</b>	C91Z	C92Z	C93Z
	<b>C95Z</b>	C96Z	C97Z	C98Z
	<b>C10Z</b>	C01Z	C02Z	C03Z
	<b>C11Z</b>	C11Z	C12Z	C13Z
	<b>C12Z</b>	C21Z	C22Z	C23Z
	<b>C13Z</b>	C31Z	C32Z	C33Z
	<b>C14Z</b>	C41Z	C42Z	C43Z

**Note:** see unipole-multipole catalogue for others available collets.

## Coaxial contacts for S and E series

Type	Impedance (Ω)	ø A (mm)	Cond. fixing	Screen fixing	Cable group	Cond. ø maxi	Dielectric ø maxi	Sheath ø		VSWR (f=GHz)	Test voltage (kV rms)	Rated current (A)
								Mini	Maxi			
A1	50	0.7	solder	collet	1	0.55	1.90	2.5	3.0	1.01 +0.127f	0.9	5
					2	0.55	1.90	1.7	2.1			
					3	0.55	1.90	2.2	2.6			
A0	50	0.9	solder	collet	2	0.95	2.95	1.7	2.1	1.06 +0.1f	3.0	6
					3	0.95	2.95	2.7	3.1			
					4	0.95	2.95	3.3	4.1			
A	50	1.6	solder	collet	4	1.35	3.95	3.3	4.1	1.01 +0.146f	1.8	12
					6	1.35	3.95	4.3	5.1			
	75	1.3	solder	collet	3	1.05	3.95	2.2	2.6	1.01 +0.19f	2.4	7
4	1.05	3.95	3.3	4.1								
5	1.05	3.95	5.3	6.1								
A3	50	3.0	solder	collet	7	2.60	8.10	10.0	10.6	1.06 +0.5f	3.0	15

## Recommended coaxial cables for 00 Series (page 18)

	LEMO cable Part Number	Type	LEMO cable group	Impedance (Ω)	Conductor ø (mm)	Dielectric ø (mm)	Screen ø (mm)	Sheath ø (mm)
Standard	CCX.50.RG5.8CU50N	RG 58 C/U	6	50 ± 2	0.90	2.95	3.60	5.00
	CCX.50.RG1.42BU50M	RG 142 B/U	7	50 ± 2	0.95	2.95	3.53 / 4.30	5.00
	CCX.50.RG1.74U25N	RG 174 /U	3	50 ± 2	0.48	1.50	2.00	2.55
	CCX.50.RG1.74AU27N	RG 174 A/U	3	50 ± 2	0.48	1.50	2.00	2.80
	CCX.50.RG1.78BU18M	RG 178 B/U	1	50 ± 2	0.30	0.84	1.30	1.80
	CCX.75.RG1.79BU26M	RG 179 B/U	2	75 ± 3	0.30	1.50	2.00	2.50
	CCX.75.RG1.87AU26B	RG 187 A/U	2	75 ± 3	0.30	1.50	2.00	2.60
	CCX.50.RG1.88AU24B	RG 188 A/U	4	50 ± 2	0.54	1.50	2.00	2.60
	CCX.95.RG1.95AU37B	RG 195 A/U	5	95 ± 5	0.30	2.52	3.10	3.70
	CCX.50.RG1.96AU20B	RG 196 A/U	1	50 ± 2	0.30	0.84	1.30	1.95
	CCX.50.RG3.16U26M	RG 316 /U	4	50 ± 2	0.54	1.50	2.10	2.60
Non standard		Huber+Suhner, G02232D-60	8	50 ± 2	0.50	1.50	1.95 / 2.40	3.10
		Huber+Suhner, K01152-07	9	50 ± 5	0.19	0.52	0.90	1.25
		Storm, 421-099	8	50 ± 2	0.50	1.52	2.00 / 2.50	3.05

**Note:** for more details on cable properties, see NIM-CAMAC catalogue.

## Recommended triaxial cables for 00 Series (page 13)

Standard	LEMO cable Part Number	Type	Impedance ( $\Omega$ )	Conductor $\varnothing$ (mm)	Dielectric $\varnothing$ (mm)	Screen 1 $\varnothing$ (mm)	Screen 2 $\varnothing$ (mm)	Sheath $\varnothing$ (mm)
		RGT 316	$50 \pm 2$	0.51	1.50	2.05	3.15	3.60
		RGT 403	$50 \pm 2$	0.30	0.84	1.30	2.35	2.95
	<b>017 410 LEDE</b>	RGT 174	$50 \pm 2$	0.48	1.55	1.90	2.90	3.90
	<b>017 820 LEDE</b>	RGT 178	$50 \pm 2$	0.30	0.90	1.37	2.30	2.80
		Huber + Suhner G 02332	$50 \pm 2$	0.49	1.50	2.00	3.05	4.25
		SMT 50	$50 \pm 2$	0.16	0.52	0.85	1.35	1.60

## Recommended coaxial cables for S and E Series (page 18)

LEMO cable Part Number	Type	LEMO cable group	Impedance ( $\Omega$ )	Conductor $\varnothing$ (mm)	Dielectric $\varnothing$ (mm)	Screen $\varnothing$ (mm)	Sheath $\varnothing$ (mm)
<b>311 100 LEDE</b>	RG 11 A/U	8	$75 \pm 2$	1.17	7.25	8.15	10.10
	RG 12 A/U	0	$75 \pm 3$	1.20	7.25	8.20	11.80
<b>CCX.50.RG5.8CU50N</b>	RG 58 C/U	6	$50 \pm 2$	0.90	2.95	3.60	5.00
<b>CCX.50.RG5.9BU62N</b>	RG 59 B/U	7	$75 \pm 3$	0.60	3.70	4.50	6.20
	RG 115 A/U	8	$50 \pm 2$	2.25	6.50	8.00	10.50
	RG 122 /U	4	$50 \pm 2$	0.80	2.50	3.20	4.10
<b>CCX.50.RG1.42BU50M</b>	RG 142 B/U	6	$50 \pm 2$	0.95	2.95	4.30	5.00
	RG 144 /U	8	$75 \pm 3$	1.35	7.25	8.00	10.40
	RG 165 /U	8	$50 \pm 2$	2.46	7.25	8.00	10.40
<b>CCX.50.RG1.74AU27N</b>	RG 174 A/U	3	$50 \pm 2$	0.48	1.50	2.00	2.80
<b>CCX.50.RG1.78BU18M</b>	RG 178 B/U	1	$50 \pm 2$	0.30	0.84	1.30	1.80
<b>CCX.75.RG1.79BU26M</b>	RG 179 B/U	5	$75 \pm 3$	0.30	1.50	2.00	2.50
<b>CCX.75.RG1.87AU26M</b>	RG 187 A/U	5	$75 \pm 3$	0.30	1.50	2.00	2.60
<b>CCX.50.RG1.88AU26B</b>	RG 188 A/U	2	$50 \pm 2$	0.54	1.50	2.00	2.60
<b>CCX.50.RG1.96AU20B</b>	RG 196 A/U	1	$50 \pm 2$	0.30	0.84	1.30	1.95
<b>213 000 LEDE</b>	RG 213 /U	8	$50 \pm 2$	2.25	7.25	8.20	10.30
	RG 214 /U	9	$50 \pm 2$	2.25	7.25	8.80	10.80
	RG 216 /U	9	$75 \pm 3$	1.20	7.25	8.80	10.80
	RG 223 /U	7	$50 \pm 2$	0.89	2.95	4.30	5.40
	RG 225 /U	9	$50 \pm 2$	2.40	7.25	8.80	10.90
	RG 302 /U	6	$75 \pm 3$	0.64	3.70	4.40	5.10
<b>CCX.50.RG3.16U26M</b>	RG 316 B/U	2	$50 \pm 2$	0.60	1.60	2.10	2.80
	RG 400 /U	6	$50 \pm 2$	1.00	2.98	4.20	5.00
	HF-2114 Dätwyler	3	$50 \pm 2$	0.48	1.30	1.90	2.70
	HF-5408/1 Dätwyler	7	$75 \pm 3$	0.60	3.80		5.60
	2YCCY 0.4/2.5 Siemens	6	$75 \pm 2$	0.40	2.50	3.70	4.50

## Recommended coaxial cables for mixed coax, multi coax for S and E Series (pages 20 to 26)

LEMO cable Part Number	Type	LEMO cable group	Impedance (Ω)	Conductor ø (mm)	Dielectric ø (mm)	Screen ø (mm)	Sheath ø (mm)
<b>CCX.50.RG5.8CU50N</b>	RG 58 C/U	6	50 ± 2	0.90	2.95	3.60	5.00
<b>CCX.50.RG5.9BU62N</b>	RG 59 B/U	5	75 ± 3	0.60	3.70	4.50	6.20
	RG 122 /U	4	50 ± 2	0.80	2.50	3.20	4.10
<b>CCX.50.RG1.42BU50M</b>	RG 142 B/U	6	50 ± 2	0.95	2.95	4.30	5.00
<b>CCX.50.RG1.74.AU27N</b>	RG 174 A/U	1	50 ± 2	0.48	1.50	2.00	2.80
<b>CCX.50.RG1.78BU18M</b>	RG 178 B/U	2	50 ± 2	0.30	0.84	1.30	1.80
<b>CCX.75.RG1.79BU26M</b>	RG 179 B/U	3	75 ± 3	0.30	1.50	2.00	2.50
<b>CCX.75.RG1.87AU26M</b>	RG 187 A/U	3	75 ± 3	0.30	1.50	2.00	2.60
<b>CCX.50.RG1.88AU26B</b>	RG 188 A/U	1	50 ± 2	0.54	1.50	2.00	2.60
<b>CCX.50.RG1.96AU20B</b>	RG 196 A/U	2	50 ± 2	0.30	0.84	1.30	1.95
<b>213 000 LEDE</b>	RG 213 /U	7	50 ± 2	2.25	7.25	8.20	10.30
	RG 223 /U	6	50 ± 2	0.89	2.95	4.30	5.40
	RG 302 /U	5	75 ± 3	0.64	3.70	4.40	5.10
<b>CCX.50.RG3.16U26M</b>	RG 316 /U	1	50 ± 2	0.54	1.50	2.10	2.60
	RG 400 /U	5	50 ± 2	1.00	2.98	4.20	5.00

Note: the cable group number corresponding to the chosen cable must be written in the variant position, see pages 15 and 17.

## Recommended triaxial cables for S and E Series (page 19)

LEMO cable Part Number	Type	LEMO cable group	Impedance (Ω)	Conductor ø (mm)	Dielectric ø (mm)	Screen 1 ø (mm)	Screen 2 ø (mm)	Sheath ø (mm)
<b>CTR.50.RG1.78BU29M</b>	RGT 178	1	50 ± 2	0.30	0.90	1.37	2.30	2.80
<b>CTR.50.RG1.74AU39N</b>	RGT 174	2	50 ± 2	0.48	1.55	1.90	2.90	3.90
	9222 Belden <sup>1)</sup>	3	50 ± 2	0.94	2.90	3.50	5.20	6.10
	HF-2318 Dätwyler	5	50 ± 2	1.60	4.80	–	–	10.20
	8215 Belden	4	75 ± 3	0.72	4.55	–	–	8.43
	8232A Belden	4	75 ± 3	0.80	3.70	–	–	8.00
	HF-2426 Dätwyler	4	75 ± 3	0.60	3.70	–	–	8.00
	RGT 179	6	75 ± 3	0.30	1.60	2.10	3.10	3.60
<b>375 029 LEDE</b>	Triax 8 Nokia	4	75 ± 3	1.00	4.50	5.20	7.20	8.50
	9267 Belden	5	75 ± 3	0.84	3.70	–	–	9.20
<b>466 140 LEDE</b>	Triax 11 Nokia	7	75 ± 3	1.40	6.50	7.20	9.40	10.90
	8233A Belden	7	75 ± 3	1.60	7.30	–	–	12.10

Note: <sup>1)</sup> when used with 1S.650 / 1E.650, please request large contact bucket («W» type).







## Product safety notice

**PLEASE READ AND FOLLOW ALL INSTRUCTIONS CAREFULLY AND CONSULT ALL RELEVANT NATIONAL AND INTERNATIONAL SAFETY REGULATIONS FOR YOUR APPLICATION. IMPROPER HANDLING, CABLE ASSEMBLY, OR WRONG USE OF CONNECTORS CAN RESULT IN HAZARDOUS SITUATIONS.**

### 1. SHOCK AND FIRE HAZARD

Incorrect wiring, the use of damaged components, presence of foreign objects (such as metal debris), and / or residue (such as cleaning fluids), can result in short circuits, overheating, and / or risk of electric shock. Mated components should never be disconnected while live as this may result in an exposed electric arc and local overheating, resulting in possible damage to components.

### 2. HANDLING

Connectors and their components should be visually inspected for damage prior to installation and assembly. Suspect components should be rejected or returned to the factory for verification. Connector assembly and installation should only be carried out by properly trained personnel. Proper tools must be used during installation and / or assembly in order to obtain safe and reliable performance.



### 3. USE

Connectors with exposed contacts should never be live (or on the current supply side of a circuit). Under general conditions voltages above 30 VAC and 42 VDC are considered hazardous and proper measures should be taken to eliminate all risk of transmission of such voltages to any exposed metal part of the connector.

### 4. TEST AND OPERATING VOLTAGES

The maximum admissible operating voltage depends upon the national or international standards in force for the application in question. Air and creepage distances impact the operating voltage; reference values are indicated in the catalog however these may be influenced by PC board design and / or wiring harnesses. The test voltage indicated in the catalog is 75% of the mean breakdown voltage; the test is applied at 500 V/s and the test duration is 1 minute.

### 5. CE MARKING

CE marking  means that the appliance or equipment bearing it complies with the protection requirements of one or several European safety directives. CE marking  applies to complete products or equipment, **but not to electromechanical components, such as connectors.**

### 6. PRODUCT IMPROVEMENTS

The LEMO Group reserves the right to modify and improve to our products or specifications without providing prior notification.

### 7. WARNING (Prop 65 State of California)

Proposition 65 requires businesses to provide warnings to Californians about significant exposures to chemicals that cause cancer, birth defects or other reproductive harm. LEMO products are exempt from proposition 65 warnings because they are manufactured, marketed, and sold solely for commercial and industrial use. For further information, please visit <https://www.lemo.com/quality/LEMO-Prop-65-compliance-declaration.pdf>.

## Disclaimers

LEMO works constantly to improve the quality of its products; the information and illustrations figuring in this document may therefore vary and are not binding. In any case, LEMO makes no specific warranty of merchantability, fitness for a particular purpose, third party components as such or included in assembly, non-infringement, title, accuracy, completeness, or security. The user is fully responsible for his products and applications using LEMO component.

In no event shall LEMO, its affiliates, officers, agents or employees be liable for any incidental, indirect, special or consequential damages in connection with the products or services provided by LEMO, including (without limitation) loss of profits or revenues, interruption of business, loss of use of the products or any associated equipment, materials, components or products, damages to associated equipment or in combination with other components, materials.

Reproduction of significant portions of LEMO information in LEMO data books or data sheets is permissible only if reproduction is without alteration and is accompanied by all associated warranties, conditions, limitations, and notices. LEMO is not responsible or liable for such altered documentation. Information of third parties may be subject to additional restrictions.

No reproduction or use without express permission of editorial or pictorial content, in any manner.  
LEMO SA reserves the right to modify and improve specifications, at all times, without any notification.

## LEMO HEADQUARTERS

### SWITZERLAND

#### LEMO SA

Chemin des Champs-Courbes 28 - P.O. Box 194 - CH-1024 Ecublens  
Tel. (+41 21) 695 16 00 - Fax (+41 21) 695 16 02 - e-mail: info@lemo.com

## LEMO SUBSIDIARIES

### AUSTRIA

#### LEMO Elektronik GesmbH

Lemböckgasse 49/E6-3  
1230 Wien  
Tel: (+43 1) 914 23 20 0  
Fax: (+43 1) 914 23 20 11  
salesAT@lemo.at

### BRAZIL

#### LEMO Latin America Ltda

Av. José Rocha Bonfim,  
214 Salas 224 / 225  
Condomínio Praça Capital  
Ed. Chicago  
Campinas / SP - Brasil 13080-650  
Tel: +55 (11) 98689 4736  
info-la@lemo.com

### CANADA

#### LEMO Canada Inc

44 East Beaver Creek Road, unit 20  
Richmond Hill, Ontario L4B 1G8  
Tel: (+1 905) 889 56 78  
Fax: (+1 905) 889 49 70  
info-canada@lemo.com

### CHINA / HONG KONG

#### LEMO Electronics (Shanghai) Co., Ltd

First Floor, Block E,  
18 Jindian Road, Pudong  
Shanghai, China, 201206  
Tel: (+86 21) 5899 7721  
Fax: (+86 21) 5899 7727  
cn.sales@lemo.com

### DENMARK

#### LEMO Denmark A/S

Mandal Allé 16A  
5500 Middelfart  
Tel: (+45) 45 20 44 00  
Fax: (+45) 45 20 44 01  
info-dk@lemo.com

### FRANCE

#### LEMO France Sàrl

24/28 Avenue Graham Bell  
Bâtiment Balthus 4  
Bussy Saint Georges  
77607 Marne la Vallée Cedex 3  
Tel: (+33 1) 60 94 60 94  
Fax: (+33 1) 60 94 60 90  
info-fr@lemo.com

### GERMANY

#### LEMO Elektronik GmbH

Hanns-Schwindt-Str. 6  
81829 München  
Tel: (+49 89) 42 77 03  
Fax: (+49 89) 420 21 92  
info@lemo.de

### HUNGARY

#### REDEL Elektronika Kft

Nagysándor József u. 6-12  
1201 Budapest  
Tel: (+36 1) 421 47 10  
Fax: (+36 1) 421 47 57  
info-hu@lemo.com

### ITALY

#### LEMO Italia srl

Viale Lunigiana 25  
20125 Milano  
Tel: (+39 02) 66 71 10 46  
Fax: (+39 02) 37 90 80 46  
sales.it@lemo.com

### JAPAN

#### LEMO Japan Ltd

2-7-22, Mita,  
Minato-ku, Tokyo, 108-0073  
Tel: (+81 3) 54 46 55 10  
Fax: (+81 3) 54 46 55 11  
info-jp@lemo.com

### MIDDLE EAST

#### LEMO Middle East Connectors LLC

Concorde Tower 6th Floor,  
Dubai Media City, P.O. Box 126732  
Dubai, United Arab Emirates  
Tel: +971 55 222 36 77  
info-me@lemo.com

### NETHERLANDS / BELGIUM

#### LEMO Connectors Nederland B.V.

Jacques Meuwissenweg 6  
2031 AD Haarlem  
Tel: +31 23 206 07 01  
info-nl@lemo.com

### NORWAY / ICELAND

#### LEMO Norway A/S

Soerumsandvegen 69,  
1920 Soerumsand  
Tel: (+47) 22 91 70 40  
Fax: (+47) 22 91 70 41  
info-no@lemo.com

### SINGAPORE

#### LEMO Asia Pte Ltd

4 Leng Kee Road,  
#06-09 SiS Building  
Singapore 159088  
Tel: (+65) 6476 0672  
Fax: (+65) 6474 0672  
sg.sales@lemo.com

### SPAIN / PORTUGAL

#### IBERLEMO SAU

Brasil, 45, 08402 Granollers  
Barcelona  
Tel: (+34 93) 860 44 20  
Fax: (+34 93) 879 10 77  
info-es@lemo.com

### SWEDEN / FINLAND

#### LEMO Nordic AB

Gunnebogatan 30, Box 8201  
163 08 Spånga  
Tel: (+46 8) 635 60 60  
Fax: (+46 8) 635 60 61  
info-se@lemo.com

### SWITZERLAND

#### LEMO Verkauf AG

Grundstrasse 22 B, 6343 Rotkreuz  
Tel: (+41 41) 790 49 40  
ch.sales@lemo.com

### UNITED KINGDOM

#### LEMO UK Ltd

12-20 North Street, Worthing,  
West Sussex, BN11 1DU  
Tel: (+44 1903) 23 45 43  
lemouk@lemo.com

### USA

#### LEMO USA Inc

P.O. Box 2408  
Rohnert Park, CA 94927-2408  
Tel: (+1 707) 578 88 11  
(+1 800) 444 53 66  
Fax: (+1 707) 578 08 69  
info-US@lemo.com

## LEMO DISTRIBUTORS

ARGENTINA, AUSTRALIA, BRAZIL, CHILE, COLOMBIA, CZECH REPUBLIC,  
GREECE, INDIA, ISRAEL, NEW ZEALAND, PERU, POLAND, RUSSIA,  
SOUTH AFRICA, SOUTH KOREA, TAIWAN, TURKEY, UKRAINE

www.lemo.com



55: AW-T662NRT 8-3 SPL ++ IMP 3ohm

# Mouser Electronics

Authorized Distributor

Click to View Pricing, Inventory, Delivery & Lifecycle Information:

## LEMO:

[RAD.0S.250.CTM](#) [EGG.2B.802.CLL1](#) [EEP.2E.675.CTL](#) [EGG.3B.846.CLL1](#) [EGG.3K.8H4.CLL1](#) [EPA.0S.250.NTN](#)  
[EPL.00.650.NLNY](#) [ERA.1S.250.CLL](#) [ERA.2S.250.CTL](#) [ERA.4S.275.CTL](#) [ERN.0S.650.CTL](#) [FAA.1S.275.CLA](#)  
[PCA.0S.650.CTLC17Z](#) [PCA.0S.650.CTXC44](#) [FFA.0E.650.CTAC30](#) [FFA.0S.250.CTAC17](#) [FFA.0S.250.CTAC27Z](#)  
[FFA.0S.650.CTAC17](#) [FFA.0S.650.CTAC32](#) [FFA.0S.650.CTAC32Z](#) [FFA.1E.250.CLAC50Z](#) [FFA.1E.250.CLAZ](#)  
[FFA.1E.250.CTAC50](#) [PSA.0S.250.CTLC17](#) [PSA.1S.650.CTLC62](#) [PSA.2S.250.CTLC52](#) [SWH.0S.650.CTMPV](#)  
[EBC.5S.810.CLL2](#) [FGG.3B.846.CLAD101](#) [EPL.00.650.NLN](#) [FGG.3K.8H2.CJCK111](#) [FFS.2B.250.ZLCE30](#)  
[ERN.1S.650.CTL](#) [ABA.1S.250.NTL](#) [ABF.0S.250.NTA](#) [ABF.1S.250.NTA](#) [FFA.1S.250.CLAC52](#) [FFA.1S.250.CTAC62](#)  
[FFA.2E.675.CTAC75](#) [FFC.00.650.CLAC17](#) [FFC.00.650.GLAC17Z](#) [FGG.3K.8H4.CLAK111](#) [PHG.3K.8H4.CLLK111](#)  
[FGL.3K.8H2.CJMK111](#) [FFA.1E.275.CTAC25Z](#) [PHG.1K.308.CLLK85](#) [EEP.2E.650.CTL](#) [FFA.1E.650.CTAC45Z](#)  
[FLA.3E.250.CLAC11E](#) [EBG.1R.803.GLM81](#) [HGP.3E.250.CLLPE](#) [EHG.1B.801.CLL2](#) [HGP.3E.275.CLLPE](#)  
[FFA.1S.275.NTAC42](#) [DCC.91.019.1AK](#) [PKG.M0.8GL.LA](#) [EGG.2B319.CLL](#)



Компания «ЭлектроПласт» предлагает заключение долгосрочных отношений при поставках импортных электронных компонентов на взаимовыгодных условиях!

Наши преимущества:

- Оперативные поставки широкого спектра электронных компонентов отечественного и импортного производства напрямую от производителей и с крупнейших мировых складов;
- Поставка более 17-ти миллионов наименований электронных компонентов;
- Поставка сложных, дефицитных, либо снятых с производства позиций;
- Оперативные сроки поставки под заказ (от 5 рабочих дней);
- Экспресс доставка в любую точку России;
- Техническая поддержка проекта, помощь в подборе аналогов, поставка прототипов;
- Система менеджмента качества сертифицирована по Международному стандарту ISO 9001;
- Лицензия ФСБ на осуществление работ с использованием сведений, составляющих государственную тайну;
- Поставка специализированных компонентов (Xilinx, Altera, Analog Devices, Intersil, Interpoint, Microsemi, Aeroflex, Peregrine, Syfer, Eurofarad, Texas Instrument, Miteq, Cobham, E2V, MA-COM, Hittite, Mini-Circuits, General Dynamics и др.);

Помимо этого, одним из направлений компании «ЭлектроПласт» является направление «Источники питания». Мы предлагаем Вам помощь Конструкторского отдела:

- Подбор оптимального решения, техническое обоснование при выборе компонента;
- Подбор аналогов;
- Консультации по применению компонента;
- Поставка образцов и прототипов;
- Техническая поддержка проекта;
- Защита от снятия компонента с производства.



#### Как с нами связаться

**Телефон:** 8 (812) 309 58 32 (многоканальный)

**Факс:** 8 (812) 320-02-42

**Электронная почта:** [org@eplast1.ru](mailto:org@eplast1.ru)

**Адрес:** 198099, г. Санкт-Петербург, ул. Калинина, дом 2, корпус 4, литера А.