

COAXIAL, TRIAXIAL, MULTI & MIXED CONNECTORS

SHORT FORM
CATALOGUE



 **LEMO**[®]

Precision modular connectors to suit your application

Since its creation in Switzerland in 1946 the LEMO Group has been recognized as a global leader of circular Push-Pull connectors and connector solutions. Today LEMO and its affiliated companies, REDEL and COELVER, are active in more than 80 countries with the help of over 40 subsidiaries and distributors.

Over 75000 connectors

The modular design of the LEMO range provides over 75000 connectors from miniature \varnothing 3 mm to \varnothing 50 mm, capable of handling cable diameters up to 30 mm and for up to 114 contacts.

This vast portfolio enables you to select the ideal connector configuration to suit almost any specific requirement in most markets, including medical devices, test and measurement instruments, machinery, audio video broadcast, telecommunications and military.

LEMO's Push-Pull Self-Latching Connection System

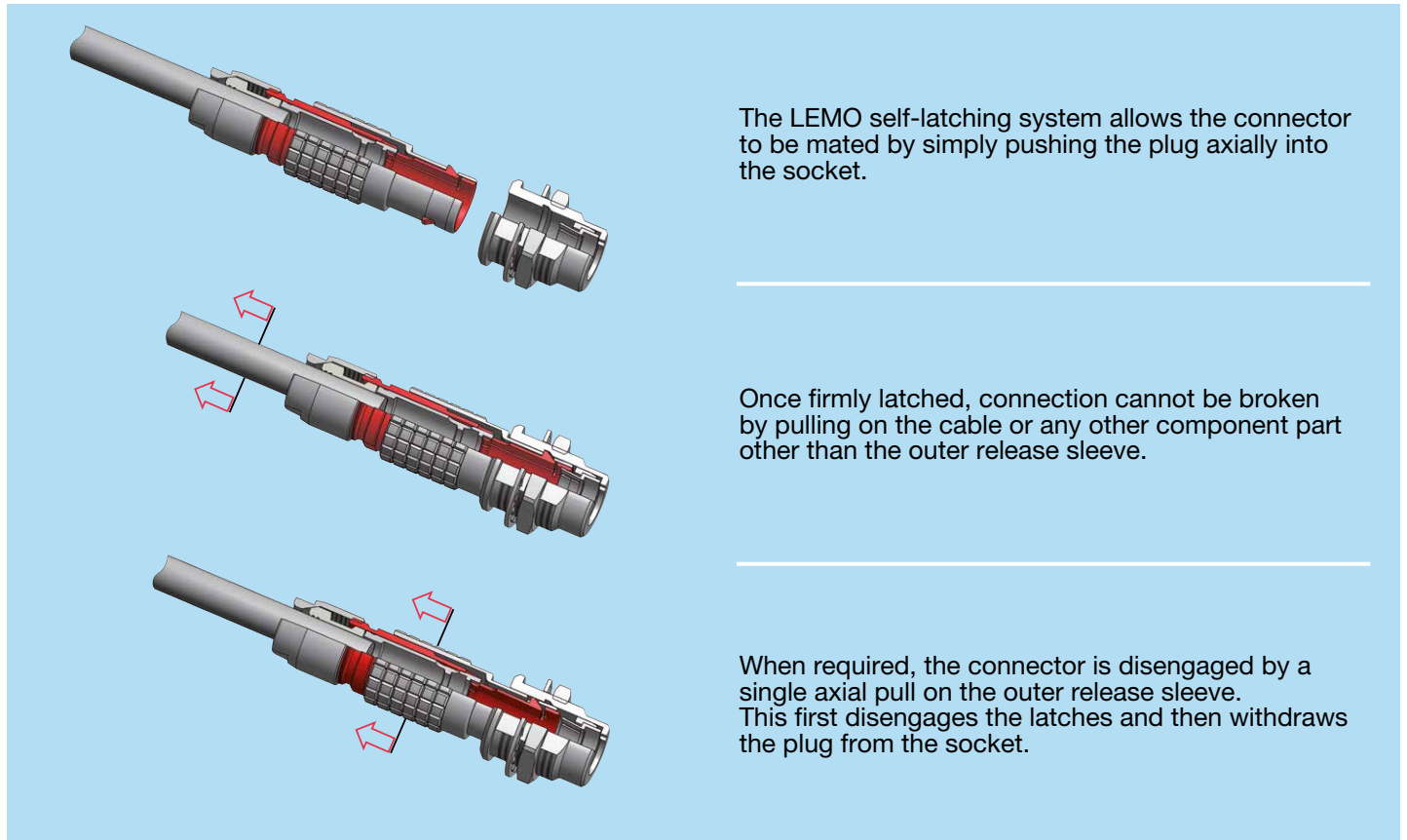

This self-latching system is renowned worldwide for its easy and quick mating and unmating features. It provides absolute security against vibration, shock or pull on the cable, and facilitates operation in a very limited space.



UL Recognition

LEMO connectors are recognized by the Underwriters Laboratories (UL). The approval of the complete system (LEMO connector, cable and your equipment) will be easier because LEMO connectors are recognized.

CE marking

CE marking  means that the appliance or equipment bearing it complies with the protection requirements of one or several European safety directives. CE marking  applies to complete products or equipment, **but not to electromechanical components, such as connectors.**

RoHS

LEMO connector specifications conforms the requirements of the RoHS directive (2011/65/EU) of the European Parliament and the latest amendments. This directive specifies the restrictions of the use of hazardous substances in electrical and electronic equipment marketed in Europe.

Introduction

This catalogue gives the complete description of LEMO connectors with coaxial, triaxial and mixed contacts. Mixed contacts include coaxial and low voltage contact configurations, as well as multi-coaxial contact configurations.

The LEMO manufacturing programme has been extended to almost 40 series divided into 7 product families with specific mating and environmental characteristics. Each series includes a wide variety of plug, socket and coupler models, available in contact configurations adapted to all round cables. The catalogue includes the B, K, S and E Series of the LEMO product range. In addition the 00 Series (triaxial) connector is also represented.

Watertight and vacuumtight models are also available. Since LEMO connectors are perfectly screened and designed to guarantee very low resistance to shell electrical continuity, they are particularly adapted to applications where electromagnetic compatibility (EMC) is important.

Material and treatment

| Component | Material (Standard) | Surface treatment (μm) | | | | | | | | | | Notes |
|--|--|-------------------------------------|----|-----|--------|----|------|----|-----|------------|----|-------|
| | | chrome | | | nickel | | gold | | | black chr. | | |
| | | Cu | Ni | Cr | Cu | Ni | Cu | Ni | Au | Ni | Cr | |
| Outer shell, collet nut, conical nut or notched nut and oversized collet | Brass (UNS C 38500) | 0.5 | 3 | 0.3 | 0.5 | 3 | 0.5 | 3 | 0.5 | 1 | 2 | |
| | Stainless steel (AISI 303, 304 or 316L) | without treatment | | | | | | | | | | |
| | Aluminium alloy (AA 6262A or AA 6023) | anodized | | | | | | | | | | |
| | POM (Delrin® or Ertacetel®), Polyoxymethylene, black | – | | | | | | | | | | 1) |
| | PEEK, Polyether ethercetone, beige | – | | | | | | | | | | 2) |
| | PSU (Udel®), Polysulfone, grey or white | – | | | | | | | | | | 3) |
| | PPSU (Radel®), Polyphenylsulfone, cream | – | | | | | | | | | | 3) |
| | PPS (Ryton®), Polyphenilene sulfide, brown | – | | | | | | | | | | 4) |
| Earthing crown | Bronze (UNS C 54400) or special brass | – | – | – | 0.5 | 3 | 0.5 | 3 | 1.0 | – | – | 5) |
| | Beryllium Copper (UNS C 17300) | – | – | – | 0.5 | 3 | 0.5 | 3 | 1.0 | – | – | 6) |
| | Stainless steel (AISI 416 or 316L) | without treatment | | | | | | | | | | 7) |
| Latch sleeve | Special brass | 0.5 | 3 | 0.3 | 0.5 | 3 | 0.5 | 3 | 0.5 | – | – | |
| | Stainless steel (AISI 416 or 316L) | without treatment | | | | | | | | | | 7) |
| Locking washer | Bronze (UNS C 52100) | – | – | – | 0.5 | 3 | 0.5 | 3 | 0.5 | – | – | |
| Hexagonal or round nut | Brass (UNS C 38500) | – | – | – | 0.5 | 3 | 0.5 | 3 | 0.5 | – | – | |
| | Stainless steel (AISI 303, 304 or 316L) | without treatment | | | | | | | | | | 8) |
| | Aluminium alloy (AA 6262A or AA 6023) | anodized natural | | | | | | | | | | 8) |
| Other metallic components | Brass (UNS C 38500) | – | – | – | 0.5 | 3 | 0.5 | 3 | 0.5 | – | – | |
| | Stainless steel (AISI 303, 304 or 316L) | without treatment | | | | | | | | | | |
| O-ring and gaskets | Silicone MQ/MVQ or FPM/FKM (Viton®) | – | | | | | | | | | | 9) |
| Sealing resin | Epoxy (Araldite® or Stycast®) | – | | | | | | | | | | |

Notes:

standards for surface treatment are as follows:

- chrome-plated: SAE AMS 2460
- nickel-plated: SAE AMS QQ N 290, or MIL DTL 32119
- gold-plated: ISO 27874
- black chrome: MIL-C-14538C with a minimum of 10 μm of lacquer protection

¹⁾ for FFP, PCP and ERN models of the 0S to 3S series

²⁾ for FFP, PCP and ERN models of the 0S to 3S series, FGG and ENG models of the 0B, 1B, 3B and 4B series, FFA and FFC models of the 00 triaxial series

³⁾ for the FGG, FGY and ENY models of the 2B to 4B series

⁴⁾ for 00 triaxial series (elbow sockets for printed circuits)

⁵⁾ gold-plating for unipole types

⁶⁾ used in 00 series free and fixed sockets

⁷⁾ AISI 416 steel is used with shells made of AISI 303 or 304

⁸⁾ delivered with free and fixed sockets with aluminium alloy or stainless steel shell

⁹⁾ FPM/FKM (Viton®) o-ring and gaskets are installed upon special request. However standard for vacuumtight models.

B Series

B series connectors provide the following main features:

- security of the Push-Pull self-latching system
- coaxial, triaxial and mixed contact configurations
- plastic models made of PSU or PPSU
- multiple key options to avoid cross mating of similar connectors («G» key standard).
- up to 10 coaxial contacts
- solder or crimp contacts
- high packing density for space savings
- 360° screening for full EMC shielding

Metal housing models

Fixed plugs



FWG

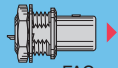

FAG

Elbow plugs

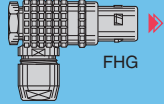

FHG

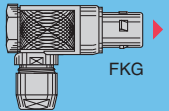

FKG

Straight plugs

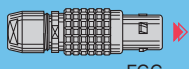

FGG

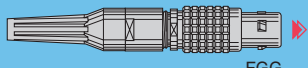

FGG

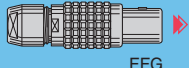

FFG

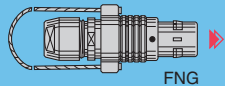

FNG

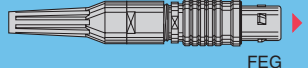

FEG

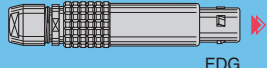

FDG

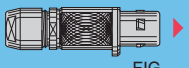

FIG

Fixed sockets



EGG



ENG



EKG



EHG



EJG



EEG



ECG

Free sockets

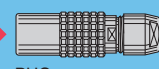

PHG

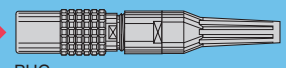

PHG

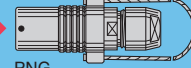

PNG

Fixed sockets

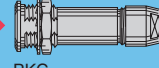

PKG

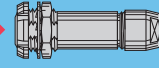

PFG

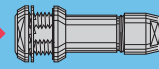

PEG

Plastic housing models

Straight plugs

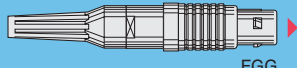

FGG

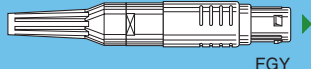

FGY

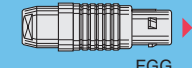

FGG

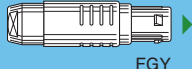

FGY

Fixed sockets



ENG

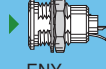

ENY

Model Description

- ECG** Fixed socket with two nuts, key (G) or keys (A...L and R) (back panel mounting)
- EEG** Fixed socket, nut fixing, key (G) or keys (A...L and R) (back panel mounting)
- EGG** Fixed socket, nut fixing, key (G) or keys (A...L and R)
- EHG** Fixed socket, nut fixing, key (G) or keys (A...L and R), and protruding shell
- EJG** Fixed socket, press or adhesive fit, key (G) or keys (A...L)
- EKG** Fixed socket, nut fixing, key (G) or keys (A...L and R), special alignment mark on the front
- ENG** Fixed socket with earthing tag, nut fixing, key (G) or keys (A...L)
- ENG** Fixed socket with earthing tag, nut fixing, key (G or J), PEEK outer shell
- ENY** Fixed socket with earthing tag, nut fixing, keys (Y), PSU or PPSU outer shell
- FAG** Fixed plug, non-latching, nut fixing, key (G) or keys (A...L and R)
- FDG** Straight plug, long version, key (G) or keys (A...L), cable collet

- FEG** Straight plug, key (G) or keys (A...L), cable collet, front seal and nut for fitting a bend relief (IP 54 protection index when mated)
- FFG** Straight plug, non-latching, key (G) or keys (A...L), cable collet
- FGG** Straight plug, key (G) or keys (A...L and R), cable collet
- FGG** Straight plug, key (G) or keys (A...L), cable collet and nut for fitting a bend relief
- FGG** Straight plug, key (G or J), cable collet, PEEK outer shell
- FGG** Straight plug, key (G or J), cable collet, PEEK outer shell, nut for fitting a bend relief
- FGY** Straight plug, keys (Y), cable collet and PSU or PPSU outer shell
- FGY** Straight plug, keys (Y), cable collet and PSU or PPSU outer shell and nut for fitting a bend relief
- FHG** Elbow (90°) plug, key (G) or keys (A...L and R), cable collet
- FIG** Straight plug for remote handling, key (G) or keys (A...L and R), special alignment mark, knurled handling surface, cable collet

- FKG** Elbow (90°) plug for remote handling, key (G) or keys (A...L), special alignment mark, knurled handling surface, cable collet
- FNG** Straight plug, key (G) or keys (A...L and R), cable collet and lanyard release
- FWG** Fixed plug, nut fixing, key (G) or keys (A...L)
- PEG** Fixed socket, nut fixing, key (G) or keys (A...L), cable collet (back panel mounting)
- PFG** Fixed socket, with two nuts, key (G) or keys (A...L and R), cable collet (back panel mounting)
- PHG** Free socket, key (G) or keys (A...L and R), cable collet
- PHG** Free socket, key (G) or keys (A...L), cable collet and nut for fitting a bend relief
- PKG** Fixed socket, nut fixing, key (G) or keys (A...L and R), cable collet
- PNG** Free socket, nut fixing, key (G) or keys (A...L and R), cable collet with lanyard release

Part Numbering System

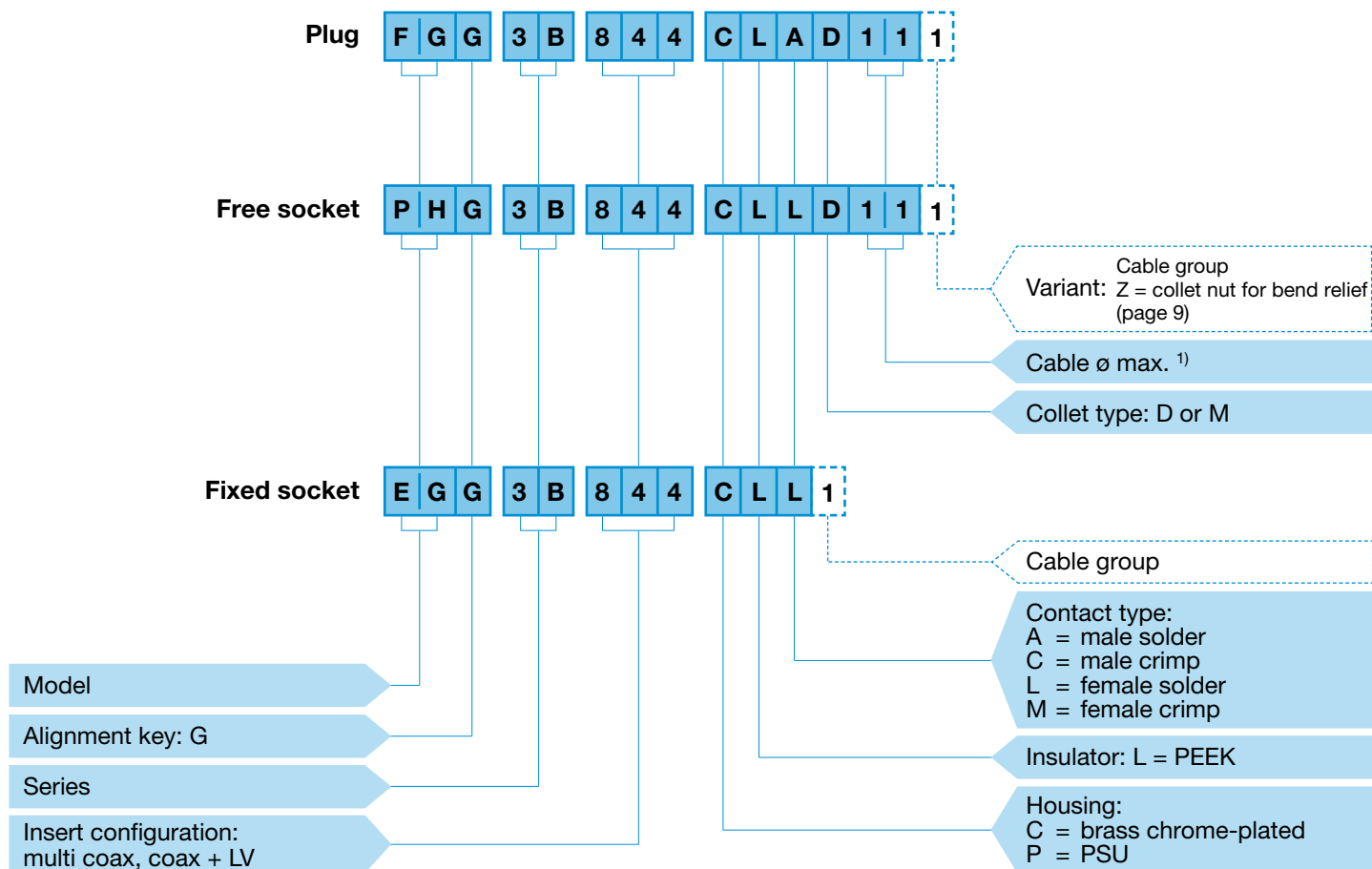

FGG.3B.844.CLAD111 = straight plug with key (G) and cable collet, 3B series, mixed coax & low voltage type (1 coax and 4 low voltage contacts), outer shell in chrome-plated brass, PEEK insulator, male solder contacts, D type collet for up to 11 mm diameter cable. Cable group 1.

PHG.3B.844.CLLD111 = free socket with key (G) and cable collet, 3B series, mixed coax & low voltage type (1 coax and 4 low voltage contacts), outer shell in chrome-plated brass, PEEK insulator, female solder contacts, D type collet for up to 11 mm diameter cable. Cable group 1.

EGG.3B.844.CLL1 = fixed socket, nut fixing, with key (G), 3B series, mixed coax & low voltage type (1 coax and 4 low voltage contacts), outer shell in chrome plated brass, PEEK insulator, female solder contacts. Cable group 1.

Note: ¹⁾ see unipole-multipole catalogue.

Part Section Showing Internal Components (mixed coax + LV)

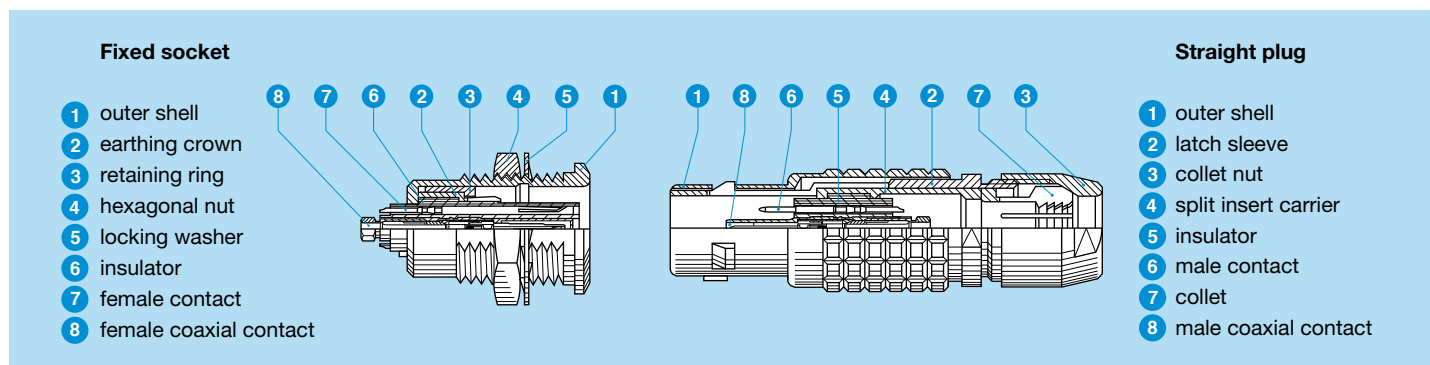

K Series

K series connectors have been specifically designed for outdoor applications.

They include an inner sleeve and two seals to prevent penetration of solids or liquids into the housing formed by the plug, free socket or fixed socket. All models of this series are watertight when mated to give a protection index of IP68 as per IEC 60529 standard (in mated condition) when correctly assembled to an appropriate cable (IP66 otherwise).

K series connectors have the same insulators as the B series and have the following main features:

- security of the Push-Pull latching system
- coaxial, triaxial and mixed contact configurations
- solder or crimp contacts
- multiple key options to avoid cross mating of similar connectors («G» key standard)
- watertight connection (IP 68/IP 66)
- up to 10 coaxial contacts
- 360° screening for full EMC shielding
- high packing density for space savings
- rugged housing for extreme working conditions.

Models

Fixed plugs

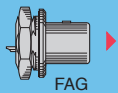
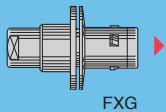

Elbow plug

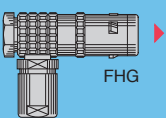

Straight plugs

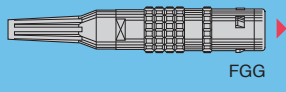
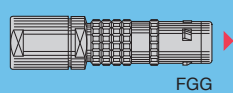
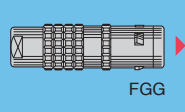

Fixed sockets

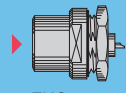
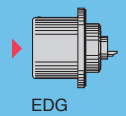
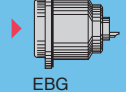
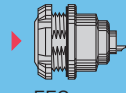
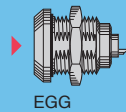

Free sockets

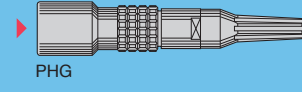
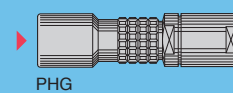
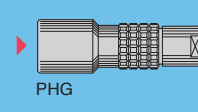

Fixed sockets

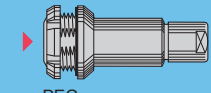
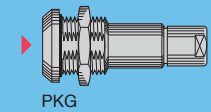

Model Description

EBG Fixed socket with square flange, key (G) or keys (A to F, L and R) and screw fixing

EDG Fixed socket with square flange, key (G) or keys (A to F, L and R), protruding shell and earthing tag, screw fixing

EEG Fixed socket, nut fixing, key (G) or keys (A to F, L and R) (back panel mounting)

EGG Fixed socket, nut fixing, key (G) or keys (A to F, L and R)

EHG Fixed socket, nut fixing, key (G) or keys (A to F and L), protruding shell

FAG Fixed plug, nut fixing, non-latching, key (G) or keys (A to F, L and R)

FGG Straight plug, key (G) or keys (A to F, L and R), cable collet

FGG Straight plug, key (G) or keys (A to F, L and R), cable collet and oversize cable collet

FGG Straight plug, key (G) or keys (A to F, L and R), cable collet and nut for fitting a bend relief

FHG Elbow (90°) plug, key (G) or keys (A to F, L and R), cable collet

FXG Fixed plug with round flange, key (G) or keys (A to F, L and R) and screw fixing

PEG Fixed socket, nut fixing, key (G) or keys (A to F, L and R), cable collet (back panel mounting)

PHG Free socket, key (G) or keys (A to F, L and R), cable collet

PHG Free socket, key (G) or keys (A to F, L and R), cable collet and oversize cable collet

PHG Free socket, key (G) or keys (A to F, L and R), cable collet and nut for fitting a bend relief

PKG Fixed socket, nut fixing, key (G) or keys (A to F, L and R), cable collet

Part Numbering System

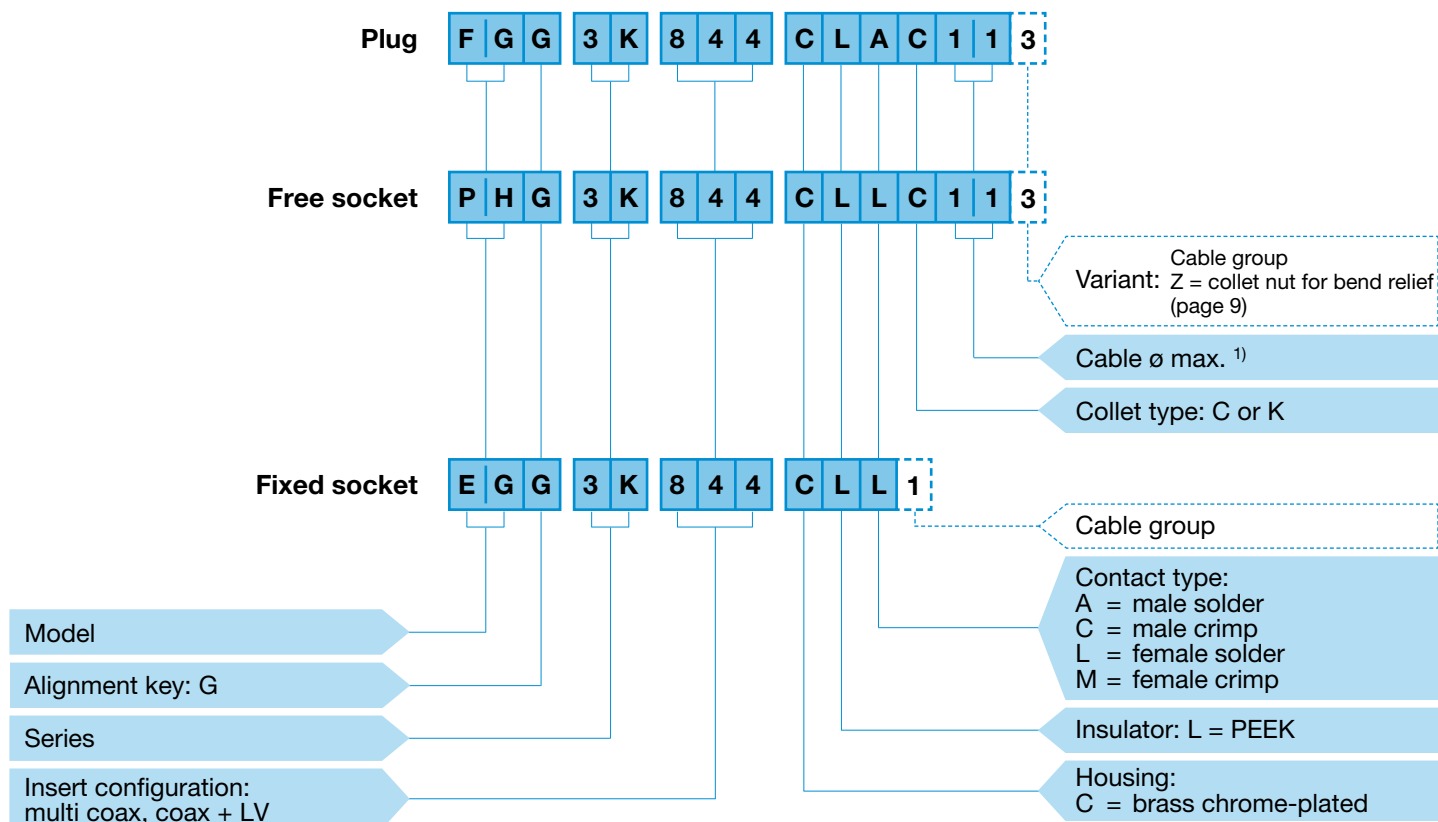

FGG.3K.844.CLAC113 = straight plug with key (G) and cable collet, 3K series, mixed coax & low voltage type (1 coax and 4 low voltage contacts), outer shell in chrome-plated brass, PEEK insulator, male solder contacts, C type collet for 10.5 mm diameter cable. Cable group 3.

PHG.3K.844.CLLC113 = free socket with key (G) and cable collet, 3K series, mixed coax & low voltage type (1 coax and 4 low voltage contacts), outer shell in chrome-plated brass, PEEK insulator, female solder contacts, C type collet for 10.5 mm diameter cable. Cable group 3.

EGG.3K.844.CLL1 = fixed socket, nut fixing, with key (G), 3K series, mixed coax & low voltage type (1 coax and 4 low voltage contacts), outer shell in chrome-plated brass, PEEK insulator, female solder contacts. Cable group 1.

Note: ¹⁾ see unipole-multipole catalogue.

Part Section Showing Internal Components (mixed coax + LV)

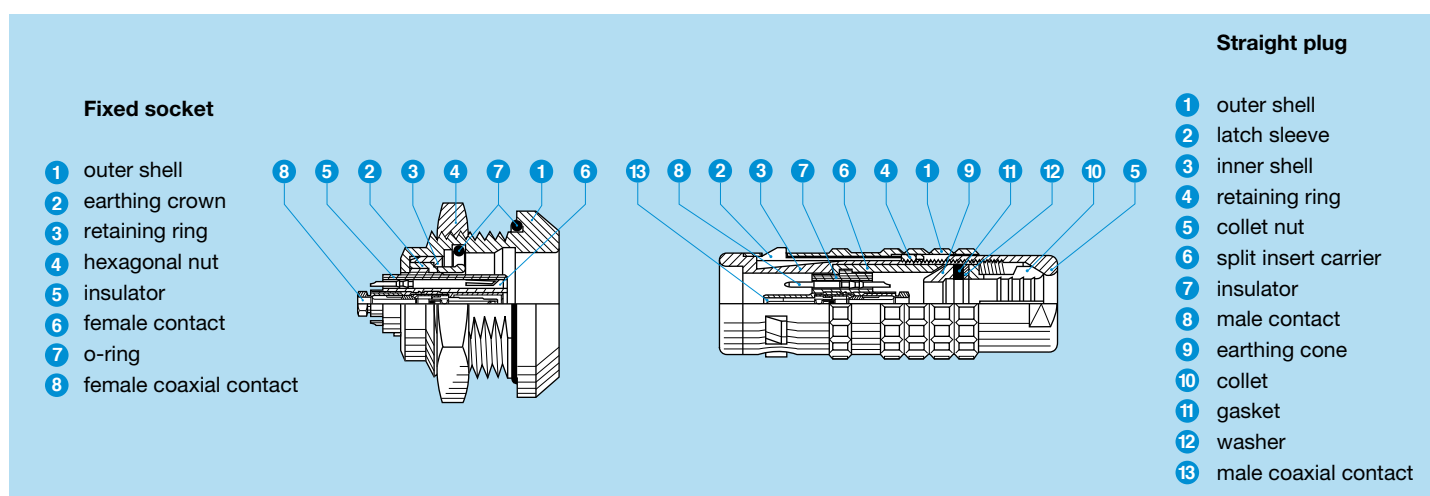

Insert configuration (B and K series)

Mixed: multi coax, coax + LV

| | | Reference | Coax | | | | Low voltage (LV) | | | | | | |
|------------------|--|------------|--------------------|---------------|--------------------|-------------|--------------------|----------|---------------|-------|-----------------------|----------------------|-------------------|
| | | | Number of contacts | Impedance (Ω) | Type (see page 10) | Cable group | Number of contacts | ø A (mm) | Contacts type | | Test voltage (kV rms) | Test voltage (kV dc) | Rated current (A) |
| | | | | | | | | | Solder | Crimp | | | |
| 1B 1K | | 801 | 1 | 50 | F | 2 | 1 | 0.9 | ● | ● | 0.85 | 1.20 | 10 |
| | | 803 | 1 | 50 | F | 2 | 3 | 0.9 | ● | ● | 0.75 | 1.05 | 10 |
| 2B 2K | | 802 | 1 | 50 | A1 | 1-2-3 | 2 | 0.9 | ● | ● | 0.85 | 1.20 | 10 |
| | | 804 | 1 | 50 | A1 | 1-2-3 | 4 | 0.7 | ● | ● | 0.75 | 1.05 | 7 |
| | | 806 | 1 | 50 | A1 | 1-2-3 | 6 | 0.7 | ● | ● | 0.75 | 1.05 | 7 |
| | | 810 | 1 | 50 | C | 1-2-3 | 10 | 0.7 | ● | ● | 0.95 | 1.35 | 7 |
| | | 841 | 2 | 50 | E | 2 | 1 | 1.6 | ● | ● | 1.90 | 2.70 | 17 |
| | | 232 | 2 | 50 | G | - | - | - | - | - | - | - | - |
| | | 243 | 3 | 50 | E | 2 | - | - | - | - | - | - | - |
| 3B 3K | | 803 | 1 | 50 | A0 | 6 | 3 | 0.9 | ● | - | 1.10 | 1.55 | 8 |
| | | 806 | 1 | 50 | A1 | 1-2-3 | 6 | 0.7 | ● | ● | 1.00 | 1.50 | 7 |
| | | 809 | 1 | 50 | A1 | 1-2-3 | 9 | 0.7 | ● | ● | 1.00 | 1.50 | 7 |
| | | 812 | 1 | 50 | A1 | 1-2-3 | 12 | 0.9 | ● | ● | 0.80 | 1.10 | 5 |
| | | 813 | 1 | 50 | A1 | 1-2-3 | 13 | 0.7 | ● | ● | 0.90 | 1.30 | 7 |
| | | 822 | 1 | 50 | C | 1-2-3 | 22 | 0.7 | ● | ● | 0.70 | 1.00 | 5 |
| | | 844 | 2 | 50 | C | 1-2-3 | 4 | 0.9 | ● | ● | 0.90 | 1.30 | 10 |
| | | 846 | 2 | 50 | C | 1-2-3 | 6 | 0.9 | ● | ● | 0.90 | 1.30 | 10 |
| | | 850 | 2 | 50 | C | 1-2-3 | 10 | 0.7 | ● | ● | 0.75 | 1.05 | 8 |
| | | 856 | 2 | 50 | C | 1-2-3 | 16 | 0.7 | ● | ● | 0.70 | 1.00 | 7 |
| | | 242 | 2 | 50 | C | 1-2-3 | - | - | - | - | - | - | - |
| | | 243 | 3 | 50 | C | 1-2-3 | - | - | - | - | - | - | - |
| | | 862 | 3 | 50 | C | 1-2-3 | 2 | 0.9 | ● | ● | 1.10 | 1.60 | 9 |

● First choice alternative ○ Special order alternative

Mixed: multi coax, coax + LV

| | | Reference | Coax | | | | Low voltage (LV) | | | | | | |
|------------|---|--------------------------|--------------------|-------------------------|--------------------|---------------|--------------------|---------------|---------------|-------|-----------------------|----------------------|-------------------|
| | | | Number of contacts | Impedance (Ω) | Type (see page 10) | Cable group | Number of contacts | ϕ A (mm) | Contacts type | | Test voltage (kV rms) | Test voltage (kV dc) | Rated current (A) |
| | | | | | | | | | Solder | Crimp | | | |
| | | 802 822 | 1 | 50 75 | A A | 5-6 4 to 6 | 2 | 0.9 | ● | ● | 1.00 | 1.40 | 12 |
| | | 804 824 | 1 | 50 75 | A A | 5-6 4 to 6 | 4 | 0.9 | ● | ● | 1.00 | 1.40 | 10 |
| | | 806 826 | 1 | 50 75 | A A | 5-6 4 to 6 | 6 | 0.9 | ● | ● | 1.00 | 1.40 | 10 |
| | | 842 | 2 | 50 | A1 | 1-2-3 | 2 | 0.9 | ● | ● | 1.70 | 2.40 | 12 |
| | | 844 | 2 | 50 | A1 | 1-2-3 | 4 | 0.9 | ● | ● | 1.70 | 2.40 | 10 |
| | | 852 | 2 | 50 | C | 1-2-3 | 12 | 0.9 | ● | ● | 0.90 | 1.30 | 8 |
| | | 856 | 2 | 50 | C | 1-2-3 | 16 | 0.9 | ● | ● | 0.90 | 1.30 | 8 |
| | | 858 | 2 | 50 | C | 1-2-3 | 18 | 0.7 | ● | ● | 0.80 | 1.10 | 7 |
| | | 866 | 3 | 50 | C | 1-2-3 | 6 | 0.7 | ● | ● | 0.80 | 1.10 | 7 |
| | | 885 | 3 | 50 | C | 1-2-3 | 12 | 0.7 | ● | ● | 0.80 | 1.10 | 8 |
| | | 244 | 4 | 50 | C | 1-2-3 | - | - | - | - | - | - | - |
| | | 879 | 4 | 50 | C | 1-2-3 | 9 | 0.7 | ● | ● | 0.90 | 1.30 | 8 |
| | | 890 | 6 | 50 | E | 2 | 18 | 0.7 | ● | ○ | 0.90 | 1.30 | 5 |
| | | 894 | 6 | 50 | E | 2 | 22 | 0.7 | ● | ○ | 0.90 | 1.30 | 4 |
| | | | | 997¹⁾ | 1 | 75 | A4 | N/A | 32 | 1.3 | ● | ○ | 1.20 |
| 840 | 1 | | | 50 | A | 5-6 | 40 | 0.9 | ● | ● | 1.30 | 1.80 | 7 |

● First choice alternative ○ Special order alternative

Note: ¹⁾ only available in 5B series. Solution for triaxial cable fixing.

Mixed: multi coax, coax + LV

| Reference | Coax | | | | Low voltage (LV) | | | | | | | |
|-----------|--------------------|------------------------|--------------------|-------------|--------------------|---------------|---------------|--------|-----------------------|----------------------|-------------------|---|
| | Number of contacts | Impedance (Ω) | Type (see page 10) | Cable group | Number of contacts | ϕ A (mm) | Contacts type | | Test voltage (kV rms) | Test voltage (kV dc) | Rated current (A) | |
| | | | | | | | Solder | Crimp | | | | |
| | 868 878 | 1 75 | B B | 6 3-5 | 4 44 | 3.0 0.9 | ● | ○ | 0.80 | 1.15 | 35 6 | |
| | 850 870 | 2 75 | B B | 6 3-5 | 10 | 0.9 | ○ | ● | 1.40 | 2.00 | 8 | |
| | 856 876 | 2 75 | B B | 6 3-5 | 16 | 0.9 | ○ | ● | 1.40 | 2.00 | 7 | |
| | 857 877 | 2 75 | B B | 6 3-5 | 2 15 | 2.0 0.9 | ○ ○ | ● ● | 1.40 1.40 | 2.00 2.00 | 30 7 | |
| | 864 | 2 | 75 | B0 | 1-6 | 24 | 1.3 | ● | ○ | 0.90 | 1.30 | 8 |
| | 273 | 3 | 75 | B1 | 5 | - | - | - | - | - | - | |
| | 274 | 4 | 75 | B1 | 5 | - | - | - | - | - | - | |
| | 892 | 6 | 75 | D | 5-8-9 | 10 | 0.9 | ● | ○ | 0.70 | 1.00 | 7 |
| | 260 | 7 | 75 | D | 5-8-9 | - | - | - | - | - | - | |
| | 240 | 10 | 50 | C | 1-2-3 | - | - | - | - | - | - | |

● First choice alternative ○ Special order alternative

Mixed: coax + LV + HV, coax + LV + Fluidic, coax + LV + Fibre optic

| | Reference | Coax | | | | | Low volt. (LV) | | High volt. (HV) | | Fibre optic (FO) | | Fluidic (FL) | |
|--|-----------|--------------------|------------------------|-------------------|--------------------|-------------|--------------------|---------------|--------------------|---------------|--------------------|------|--------------------|------------------------|
| | | Number of contacts | Impedance (Ω) | Rated current (A) | Type (see page 10) | Cable group | Number of contacts | ϕ A (mm) | Number of contacts | ϕ A (mm) | Number of contacts | Type | Number of contacts | Inner tube ϕ (mm) |
| | 932 | 1 | 50 | 2.0 | C | 1 | 2 ¹⁾ | 0.7 | 1 ²⁾ | 0.7 | - | - | - | - |
| | | 3B 3K | 934 | 1 | 50 | 2.0 | C | 1 | 4 | 0.9 | 1 | 0.9 | - | - |
| | 970 | 1 | 50 | 2.0 | C | 1 | 10 | 0.7 | - | - | - | - | 1 | 1.3 |
| | 986 | 1 | 50 | 2.0 | C | 1 | 16 | 0.7 | - | - | 1 | F2 | - | - |

Note: ¹⁾ Test voltage LV contact-shell 1.9 (kV rms). ²⁾ Test voltage HV contact-shell 7.5 (kV rms). Total rated current for 2B.932 configuration 6 (A).

Collet nut for fitting a bend relief (B and K series)

D type collets for B series

| | Clamping | Coax cable groupe | | |
|---|----------|-------------------|------|------|
| | | 1 | 2 | 3 |
| B | D52Z | D51Z | D52Z | D53Z |
| | D62Z | D61Z | D62Z | D63Z |
| | D92Z | D91Z | D92Z | D93Z |
| | D10Z | D01Z | D02Z | D03Z |
| | D11Z | D11Z | D12Z | D13Z |
| | D12Z | D21Z | D22Z | D23Z |

C type collets for K series

| | Clamping | Coax cable groupe | | |
|---|----------|-------------------|------|------|
| | | 1 | 2 | 3 |
| K | C50Z | C51Z | C52Z | C53Z |
| | C55Z | C56Z | C57Z | C58Z |
| | C80Z | C81Z | C82Z | C83Z |
| | C85Z | C86Z | C87Z | C88Z |
| | C90Z | C91Z | C92Z | C93Z |
| | C95Z | C96Z | C97Z | C98Z |
| | C10Z | C01Z | C02Z | C03Z |
| | C11Z | C11Z | C12Z | C13Z |
| | C12Z | C21Z | C22Z | C23Z |
| | C13Z | C31Z | C32Z | C33Z |
| | C14Z | C41Z | C42Z | C43Z |

Note: see unipole-multipole catalogue for others available collets.

Coaxial contacts for B and K series

| Type | Impedance (Ω) | ϕ A (mm) | Cond. fixing | Screen fixing | Cable group | Mini Cond. ϕ maxi Maxi | Dielectric ϕ maxi | Sheath ϕ | | VSWR (f=GHz) | Test voltage (kV rms) | Rated current (A) | |
|---------------------------|------------------------|---------------|--------------|---------------|-------------|-----------------------------------|------------------------|---------------|--------|-----------------------------|-----------------------|-------------------|--------|
| | | | | | | | | Mini | Maxi | | | | |
| F ^{1) 3)} | 50 | 0.5 | solder | crimp | 2 | 0.35 | 1.05 | – | 2.10 | 1.05 +1.83f | 0.8 | 2 | |
| A1 | 50 | 0.7 | solder | collet | 1 | 0.60 | 1.90 | 2.5 | 3.00 | 1.01 +0.127f | 0.9 | 5 | |
| | | | | | 2 | | | 1.7 | 2.10 | | | | |
| | | | | | 3 | | | 2.2 | 2.60 | | | | |
| C ¹⁾ | 50 | 0.6 | crimp | crimp | 1 | 0.50 0.58 | 1.65 | – | 3.00 | 1.04 +0.1f | 1.6 | 2 | |
| | | | | | 2 | 0.28 0.35 | | | 2.35 | | | | |
| | | | | | 3 | 0.28 0.35 | | | 3.00 | | | | |
| E ^{1) 3)} | 50 | 0.5 | solder | crimp | 2 | 0.35 | 0.95 | – | 2.00 | 1.02 +0.93f | 0.8 | 2 | |
| A | 50 | 1.6 | solder | collet | 5 | 1.35 | 3.95 | 4.3 | 5.10 | 1.01 +0.146f | 1.8 | 12 | |
| | | | | | 6 | | | 5.3 | 6.10 | | | | |
| | | | | | 75 | | | 1.3 | solder | | | | collet |
| 5 | 1.05 | 3.95 | 4.3 | 5.10 | | | | | | | | | |
| 6 | 1.05 | 3.95 | 5.3 | 6.10 | | | | | | | | | |
| A4 | 75 | 1.3 | solder | collet | none | 1.05 | 3.95 | 6.7 | 7.60 | 1.01 +0.19f | 2.4 | 7 | |
| B ¹⁾ | 50 | 0.9 | solder | crimp | 6 | 1.05 | 3.75 | – | 6.25 | 1.06 +0.156f | 0.8 | 11 | |
| | | | | | | | | | | | | | 75 |
| 5 | 0.80 | 3.75 | | | | | | | | | | | |
| B0 | 75 | 0.6 | solder | solder | 1 | 0.75 | 2.95 | – | 4.25 | 1.00 +0.22f | 2.1 | 6 | |
| 6 | 0.75 | 3.75 | | | | | | | | | | | |
| B1 ¹⁾ | 75 | 0.6 | crimp | crimp | 5 | 0.55 0.80 | 3.75 | – | 6.25 | 1.00 +0.22f | 2.1 | 6 | |
| D ¹⁾ | 75 | 0.5 | solder | crimp | 5 | 0.75 | 3.75 | – | 5.40 | 1.00 +0.38f | 1.0 | 5 | |
| | | | | | 8 | | | | 0.75 | | | | 2.45 |
| | | | | | 9 | | | | 0.75 | | | | 3.00 |
| G ³⁾ | 50 | 0.5 | solder | crimp | 1 | 0.35 | 1.65 | – | 3.00 | 1.01 +0.73f | 0.4 | 2 | |
| A0 | 50 | 1.3 | solder | collet | 6 | 0.95 | – | 3.3 | 4.10 | 1.02 +0.3f ²⁾ | 3.0 | 12 | |

Note:

¹⁾ These contacts require specific tools for assembly on the cable, see page 11.

²⁾ Frequency range with SWR \leq 1.2 = 0 - 1.5 GHz.

³⁾ Coax contact design differs, the central pin is reverse gender.

Recommended coaxial cables for mixed coax, multi coax for B and K Series

| LEMO cable Part Number | Type | LEMO cable group | Impedance (Ω) | Conductor ϕ (mm) | Dielectric ϕ (mm) | Screen ϕ (mm) | Sheath ϕ (mm) |
|---------------------------|------------|------------------|--------------------------|-----------------------|------------------------|--------------------|--------------------|
| | RG 6 A/U | 7 | 75 \pm 3 | 0.73 | 4.70 | 6.20 | 8.45 |
| 311 100 LEDE | RG 11 A/U | 9 | 75 \pm 2 | 1.17 | 7.25 | 8.15 | 10.10 |
| CCX.50.RG5.8CU50N | RG 58 C/U | 6 | 50 \pm 2 | 0.90 | 2.95 | 3.60 | 5.00 |
| CCX.50.RG5.9BU62N | RG 59 B/U | 5 | 75 \pm 3 | 0.60 | 3.70 | 4.50 | 6.20 |
| CCX.50.RG1.74AU27N | RG 174 A/U | 1 | 50 \pm 2 | 0.48 | 1.50 | 2.00 | 2.80 |
| CCX.50.RG1.78BU18M | RG 178 B/U | 2 | 50 \pm 2 | 0.30 | 0.84 | 1.30 | 1.80 |
| CCX.75.RG1.79BU26M | RG 179 B/U | 3 | 75 \pm 3 | 0.30 | 1.50 | 2.00 | 2.50 |
| | RG 180 B/U | 4 | 95 \pm 5 ¹⁾ | 0.30 | 2.60 | 3.10 | 3.60 |
| CCX.75.RG1.87AU26B | RG 187 A/U | 2 | 75 \pm 3 | 0.30 | 1.50 | 2.00 | 2.60 |
| CCX.50.RG1.88AU26B | RG 188 A/U | 1 | 50 \pm 2 | 0.54 | 1.50 | 2.00 | 2.60 |
| CCX.50.RG1.96AU20B | RG 196 A/U | 1 | 50 \pm 2 | 0.30 | 0.84 | 1.30 | 1.95 |
| CCX.50.RG3.16U26M | RG 316 /U | 1 | 50 \pm 2 | 0.60 | 1.60 | 2.10 | 2.80 |

Note: ¹⁾ when no defined impedance is required.

The cable group number corresponding to the chosen cable must be written in the variant position, see pages 3 and 5.

Tooling for coaxial contacts of B and K series

| Coaxial contact type | Imp. Ω | Cable group | Reference | | |
|----------------------|---------------|-------------|------------------------|------------------------------------|-----------------------|
| | | | Crimping tool with die | Spanner for tightening the contact | Extractor |
| F | 50 | 2 | DPE.99.025.45K | DCC.91.019.1AK | – |
| C ¹⁾ | 50 | 1-3 | DPE.99.103.8K | – | DCC.91.384.5LA |
| | 50 | 2 | DPE.99.103.1K | – | DCC.91.384.5LA |
| E | 50 | 2 | DPE.99.002.5K | DCC.91.050.2LA | – |
| B | 50 | 6 | DPE.99.176.2K | – | DCC.91.804.5LA |
| | 75 | 3 | DPE.99.125.2K | – | DCC.91.804.5LA |
| | 75 | 5 | DPE.99.127.0K | – | DCC.91.804.5LA |
| B1 | 75 | 5 | DPE.99.127.0K | – | DCC.91.808.0LC |
| D | 75 | 5 | DPE.99.006.2K | DCB.91.685.8TN | – |
| | 75 | 8 | DPE.99.005.2K | DCB.91.685.8TN | – |
| | 75 | 9 | DPE.99.005.5K | DCB.91.685.8TN | – |

Note: ¹⁾ for the 3B.243/3K.243 and 3B.862/3K.862 the extractor is part number DCC.91.393.4LT.

00.650 Series

The 00 Series are available in triax configuration, allowing a very compact solution for triaxial cables.

These connectors are designed for small diameter ranging from 1.1 to 3.5 mm.

Either twinax (2 shielded connectors) or triax (1 conductor and 2 concentric separate screens) can be used with the 00 Series. The 00 Series with a 650 configuration insert are mostly used in audio-video applications where a large density of connection is required.

LEMO 00 Series connectors offer customers many benefits including:

- self-latching push-pull system
- aesthetically pleasing appearance
- small size
- high packing density
- rugged construction.
- ease of use
- low weight
- reliable performances
- wide choice to suit application

Metal housing models

Elbow plug

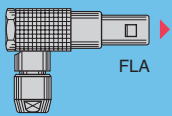

FLA

Straight plugs

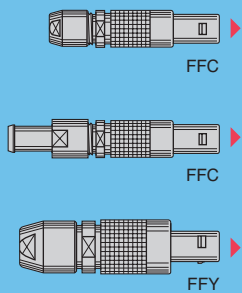

FFC

FFC

FFY

Fixed and free sockets

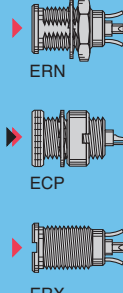

ERN

ECP

ERX

Free socket



PCA

Elbow socket

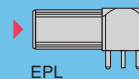

EPL

Fixed socket

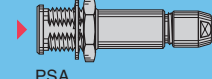

PSA

Plastic housing model

Straight plug



FFC

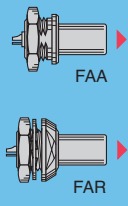

FAA

FAR

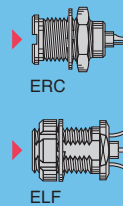

ERC

ELF

Threaded latching models

Straight plug

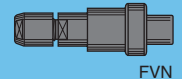

FVN

Fixed socket



ELF

Model Description

ECP Fixed socket with 2 round nuts (back panel mounting)

ELF Fixed socket, nut fixing, threaded shell with tag (back panel mounting)

ELF Fixed socket, nut fixing, threaded shell with tag, black chromium-plated outer shell (back panel mounting)

EPA Straight socket for printed circuit board

EPL Elbow plug (90°) for printed circuit board

ERC Fixed socket, with thread, with slots in flange

ERN Fixed socket with nut fixing and tags

ERX Fixed socket with nut fixing, slots on flange and tags

FAA Straight plug non latching with nut

FAR Straight plug non latching with 2 nuts (back panel mounting)

FFC Straight plug with flats on latch sleeve and cable collet

FFC Straight plug with flats on latch sleeve and cable collet and nut for fitting a bend relief

FFC Straight plug with flats on latch sleeve and cable collet, black POM (Delrin®) outershell)

FFY Straight plug, large shell with cable collet

FLA Elbow socket (90°) with cable collet

FVN Straight plug with cable collet, black chromium-plated outer shell

PCA Free socket with cable collet

PSA Fixed socket, nut fixing, cable collet

Part Section Showing Internal Components

Fixed socket

- 1 outer shell
- 2 earthing crown
- 3 retaining ring
- 4 hexagonal nut
- 5 locking washer
- 6 insulator
- 7 female triaxial contact

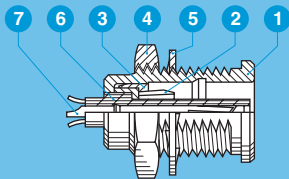

Straight plug

- 1 outer shell
- 2 latch sleeve
- 3 collet nut
- 4 earthing sleeve
- 5 rear insulator
- 6 insulator
- 7 male triaxial contact
- 8 collet

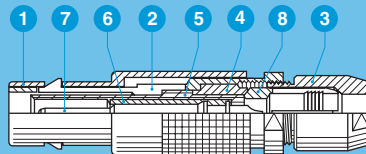

Part Numbering System

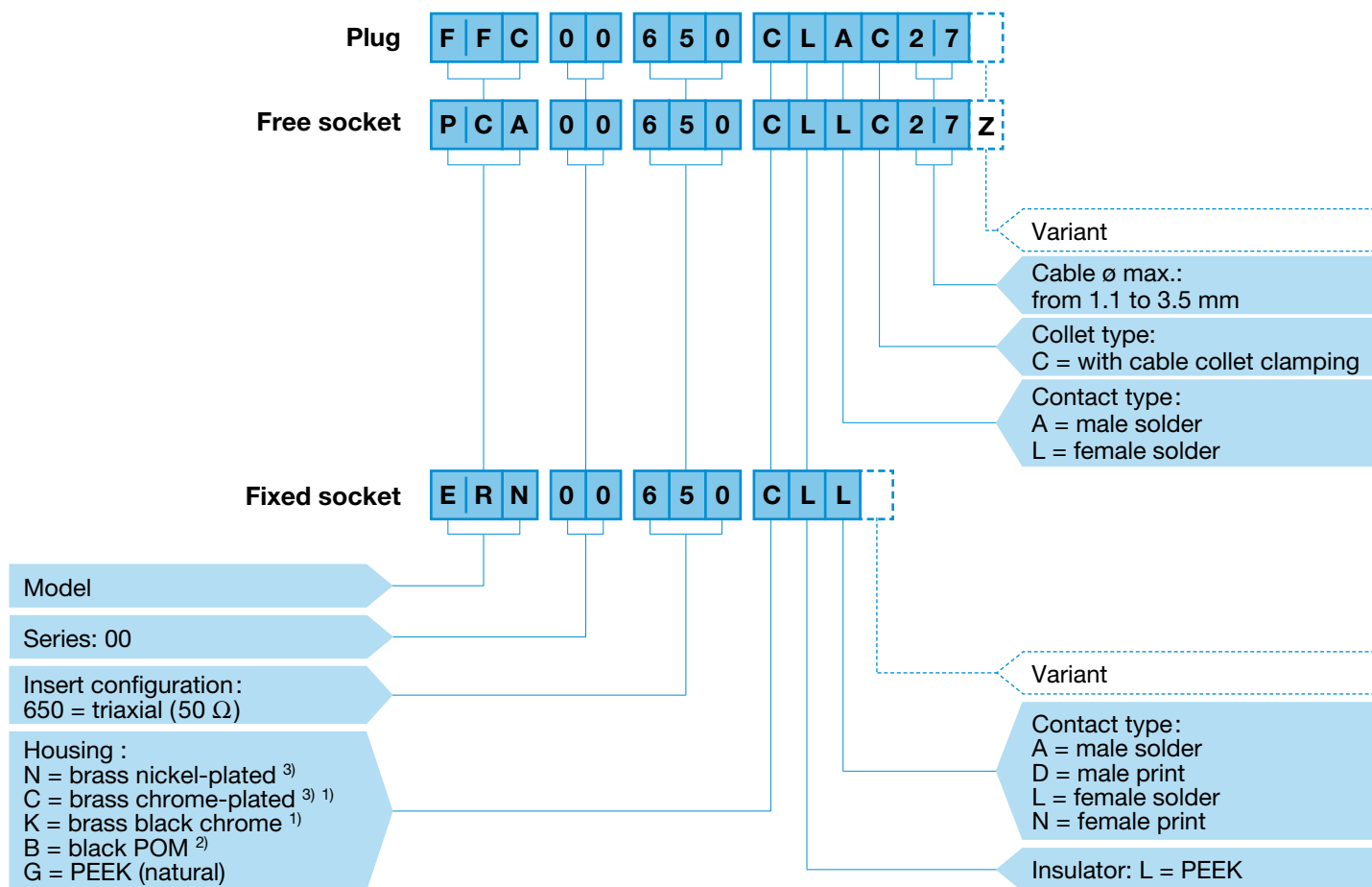

FFC.00.650.CLAC27 = straight plug with flats on latch sleeve and cable collet, 00 Series, triaxial (50 Ω), outer shell in chrome-plated brass, PEEK insulator, C type collet for an up to 2.6 mm diameter cable.

PCA.00.650.CLLC27Z = free socket with cable collet, 00 Series, triaxial (50 Ω), outer shell in chrome-plated brass, PEEK insulator, C type collet for an up to 2.6 mm diameter cable and nut for fitting a bend relief.

ERN.00.650.CLL = fixed socket with nut fixing and tags, 00 Series, triaxial (50 Ω), outer shell in chrome-plated brass, PEEK insulator.

Note: ¹⁾ treatment not available for the printed circuit models. ²⁾ available for the FFC model only. ³⁾ standard.

Insert configuration

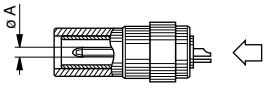
| | Reference | Series | | Impedance (Ω) | ø A (mm) | Cable group | Cond. ø max | Dielectric ø maxi | Sheath ø maxi | VSWR (f=GHz) | Test voltage (kV rms) | Rated current (A) |
|---|------------|----------|------------|---------------|----------|---------------|-------------|-------------------|---------------|---------------|-----------------------|-------------------|
| | | Standard | Watertight | | | | | | | | | |
|  | 650 | 00 | - | 50 | 0.5 | ¹⁾ | 0.55 | 2.9 | 3.5 | 1.02 +0.9f | 0.6 | 4 |

Note: ¹⁾ 00.650 is designed for use with 2 conductors screened cable (twinax).

S Series

S series connectors have main features as follows:

- security of the Push-Pull self-latching system
- solder contacts, print contacts only for coaxial and triaxial configurations
- 360° screening for full EMC shielding.

- coaxial, triaxial and mixed contact configurations
- polarisation by stepped insert (half-moon)
- up to 8 coaxial contacts

Metal housing models

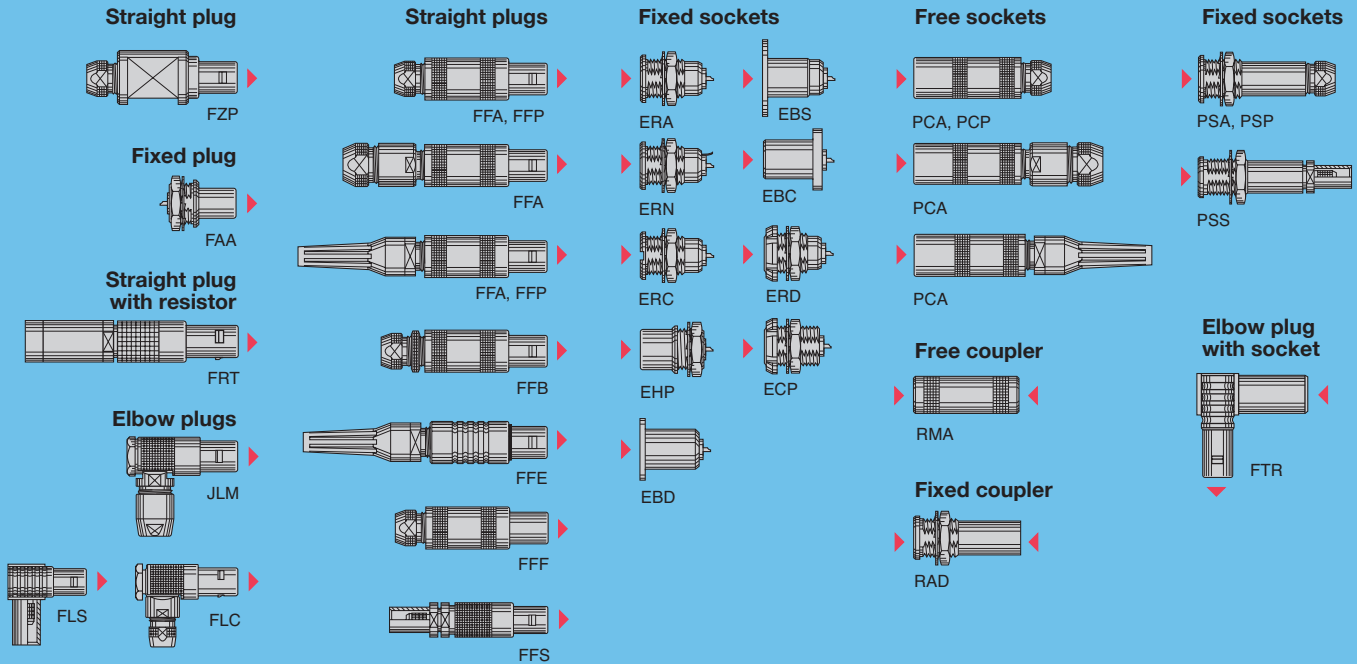

Plastic housing models

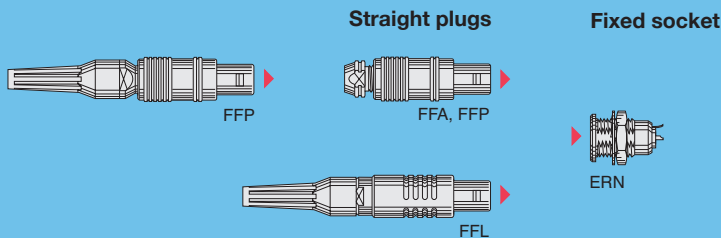

Watertight or vacuumtight models

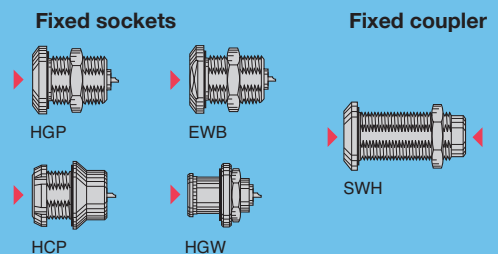

Model Description

- EBC** Fixed socket with square flange, protruding shell and screw fixing
- EBD** Fixed socket with square flange, screw fixing
- EBS** Fixed socket with round flange, screw fixing
- ECP** Fixed socket with two nuts, long threaded shell (back panel mounting)
- EHP** Fixed socket, nut fixing, protruding shell
- ERA** Fixed socket, nut fixing
- ERC** Fixed socket, nut fixing, slot in the flange
- ERD** Fixed socket with two nuts (back panel mounting)
- ERN** Fixed socket, nut fixing, with earthing tag
- ERN** Fixed socket, nut fixing, with earthing tag, PEEK or POM outer shell
- EWB** Fixed socket, nut fixing, with two flats on the flange, watertight or vacuumtight
- FAA** Fixed plug non-latching, nut fixing
- FFA** Straight plug, cable collet
- FFA** Straight plug with oversize cable collet
- FFA** Straight plug, cable collet and nut for fitting a bend relief
- FFA** Straight plug, cable collet, PEEK or POM outer shell
- FFB** Straight plug, cable collet and safety locking ring
- FFE** Straight plug, cable collet, front seal and nut for fitting a bend relief (protected to IP54 when mated)
- FFF** Straight plug, non-latching, cable collet
- FFP** Straight plug, cable collet and inner anti-rotating device
- FFP** Straight plug, cable collet, PEEK or POM outer shell and inner anti-rotating device
- FFP** Straight plug, cable collet, PEEK or POM outer shell, inner anti-rotating device and nut for fitting a bend relief
- FFS** Straight plug for cable crimping
- FLC** Elbow (90°) plug, cable collet
- FLC** Elbow (90°) plug, cable collet and nut for fitting a bend relief
- FLS** Elbow (90°) plug for cable crimping
- FRT** Straight plug with resistor
- FTR** Elbow (90°) plug with socket
- FZP** Straight plug for remote handling, cable collet and inner anti-rotating device
- HCP** Fixed socket, nut fixing, watertight or vacuumtight (back panel mounting)
- HGP** Fixed socket, nut fixing, watertight or vacuumtight
- HGW** Fixed socket, nut fixing, with back washer, watertight or vacuumtight
- JLM** Elbow (90°) plug, cable collet
- PCA** Free socket, cable collet
- PCA** Free socket with oversize cable collet
- PCA** Free socket, cable collet and nut for fitting a bend relief
- PCP** Free socket, cable collet and inner anti-rotating device
- PSA** Fixed socket, nut fixing, cable collet
- PSP** Fixed socket, nut fixing, cable collet and inner anti-rotating device
- PSS** Free socket, nut fixing for cable crimping
- RAD** Fixed coupler, nut fixing
- RMA** Free coupler
- SWH** Fixed coupler, nut fixing, watertight or vacuumtight

Part Numbering System

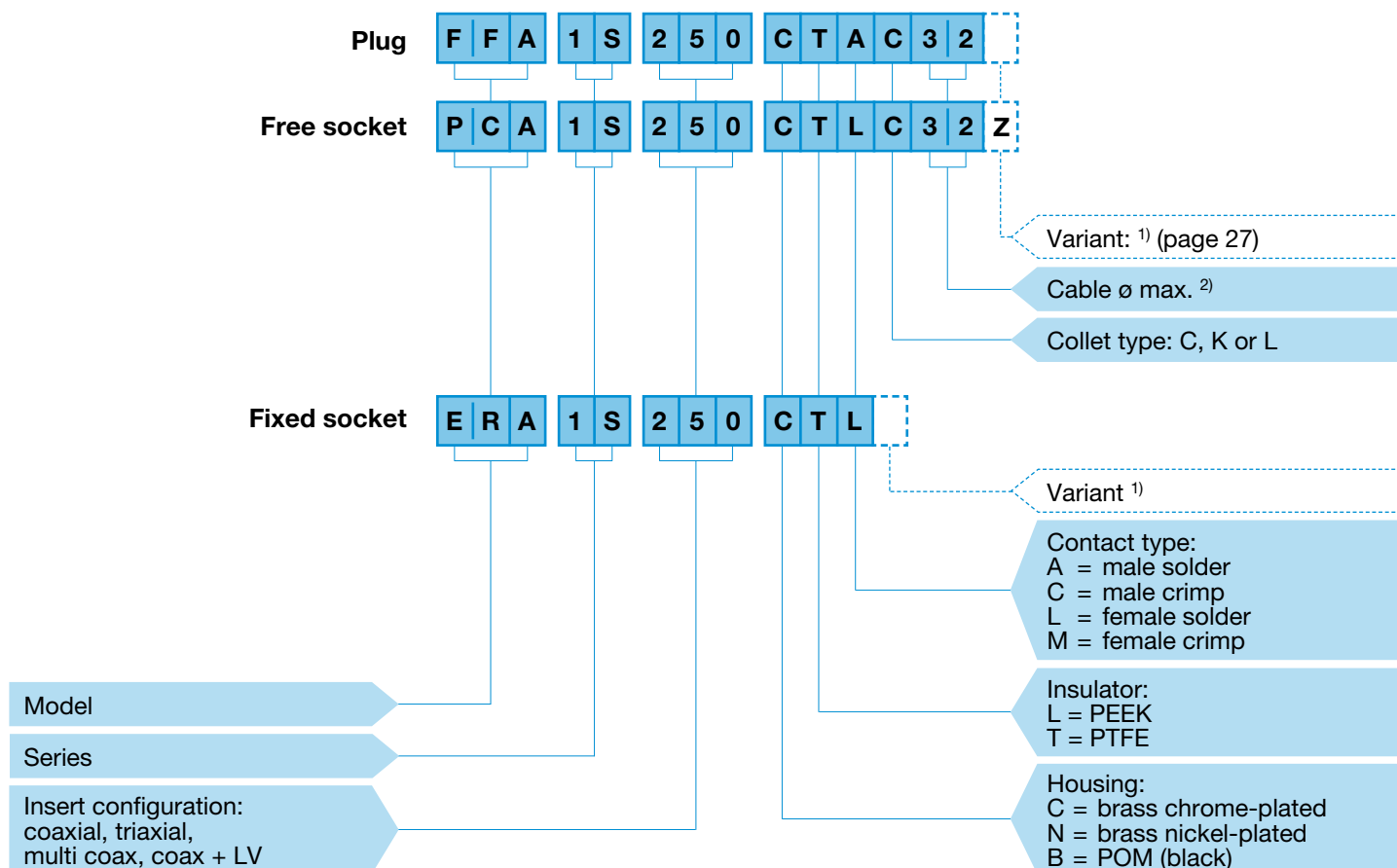

FFA.1S.250.CTAC32 = straight plug with cable collet, 1S series, coaxial (50 Ω), outer shell in chrome-plated brass, PTFE insulator, male solder contact, C type collet for a 3.2 mm diameter cable.

PCA.1S.250.CTLC32Z = free socket with cable collet, 1S series, coaxial (50 Ω), outer shell in chrome-plated brass, PTFE insulator, female solder contact, C type collet for a 3.2 mm diameter cable and nut for fitting a bend relief.

ERA.1S.250.CTL = fixed socket, nut fixing, 1S series, coaxial (50 Ω), outer shell in chrome-plated brass, PTFE insulator, female solder contact.

Note: ¹⁾ for mixed contacts, add cable group to the part number.
²⁾ see unipole-multipole catalogue.

Part Section Showing Internal Components (mixed coax + LV)

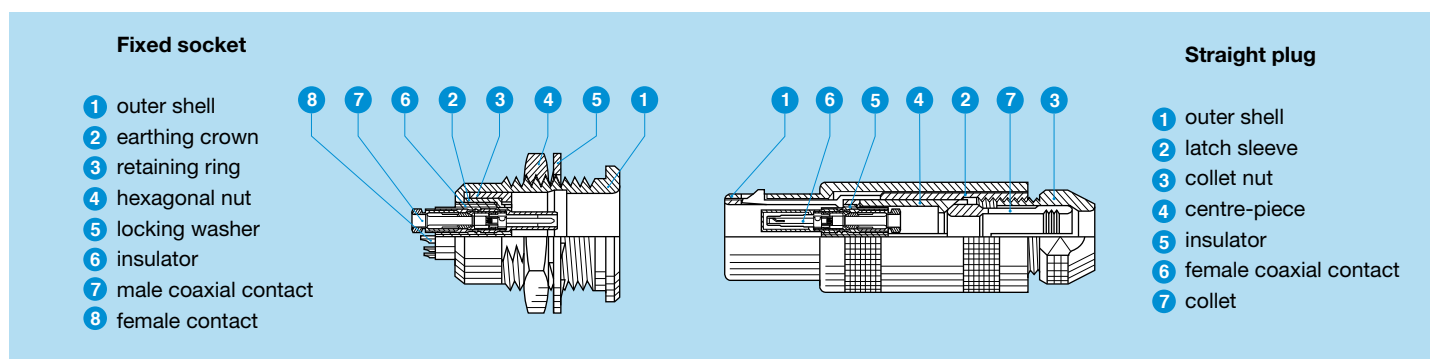

E Series

E series connectors have been specifically designed for outdoor applications.

They include an inner sleeve and two seals to prevent penetration of solids or liquids into the housing formed by the plug, free socket or fixed socket. All models of these series are watertight when mated and give a protection index of IP 68 as per IEC 60529 standard (in mated condition) when correctly assembled to an appropriate cable (IP 66 otherwise).

- security of the Push-Pull latching system
- watertight connection (IP 68/IP 66)
- solder contacts, print contacts only for coaxial and triaxial configurations
- coaxial, triaxial and mixed contact configurations
- polarization by stepped insert (half-moon)
- 360° screening for full EMC shielding
- rugged housing for extreme working condition.

Models

Straight plug

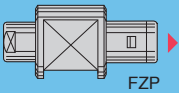

FZP

Fixed plug

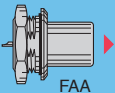

FAA

Elbow plug

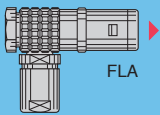

FLA

Straight plugs

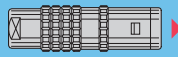

FFA

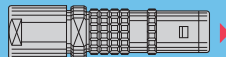

FFA

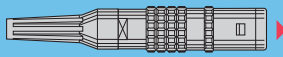

FFA

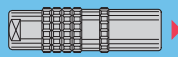

FFF

Fixed sockets

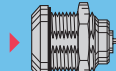

ERA



ERB

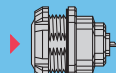

EEP

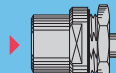

EHP

Free sockets

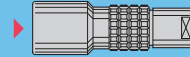

PCA

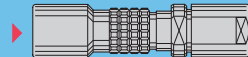

PCA

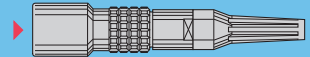

PCA

Fixed socket

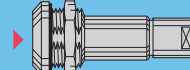

PSA

Watertight or vacuumtight models

Fixed sockets

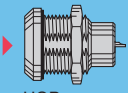

HGP

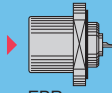

EBR

Fixed coupler

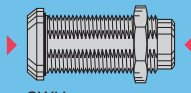

SWH

Free coupler

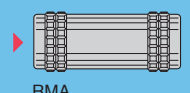

RMA

Model Description

- EBR** Fixed socket with round flange, watertight, protruding shell and screw fixing
- EEP** Fixed socket, nut fixing (back panel mounting)
- EHP** Fixed socket, nut fixing, protruding shell
- ERA** Fixed socket, nut fixing
- ERB** Fixed socket, nut fixing with two flats in the flange
- FAA** Fixed plug non-latching, nut fixing
- FFA** Straight plug, cable collet

- FFA** Straight plug with oversize cable collet
- FFA** Straight plug, cable collet and nut for fitting a bend relief
- FFF** Straight plug non-latching, cable collet
- FLA** Elbow (90°) plug, cable collet
- FZP** Straight plug for remote handling, cable collet and inner anti-rotating device
- HGP** Fixed socket, nut fixing, watertight or vacuumtight
- PCA** Free socket, cable collet

- PCA** Free socket with oversize cable collet
- PCA** Free socket, cable collet and nut for fitting a bend relief
- PSA** Fixed socket, nut fixing, cable collet
- RMA** Free coupler
- SWH** Fixed coupler, nut fixing, watertight or vacuumtight

Part Numbering System

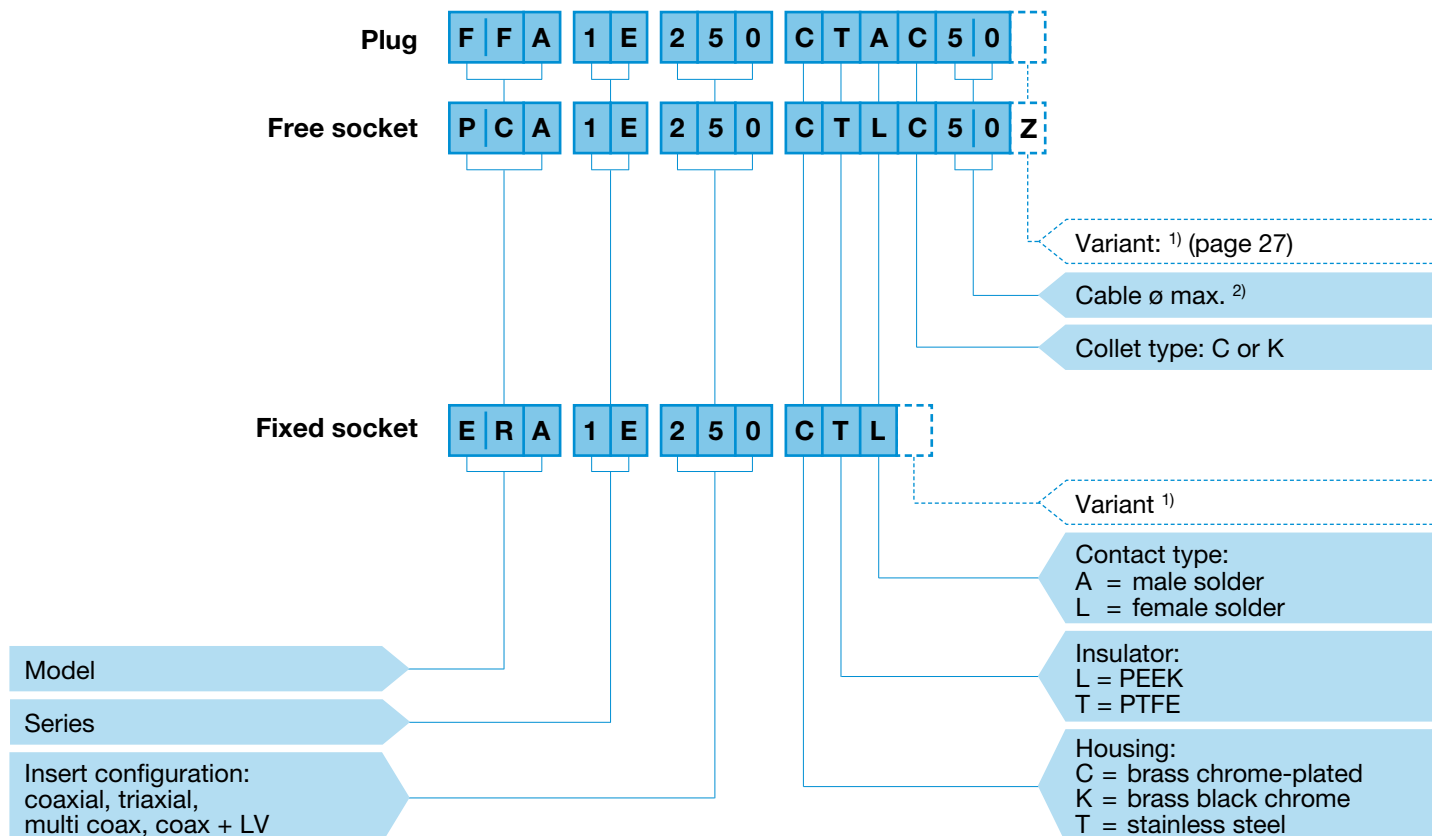

FFA.1E.250.CTAC50 = straight plug with cable collet, 1E series, coaxial (50 Ω), outer shell in chrome-plated brass, PTFE insulator, C type collet for an up to 5.0 mm diameter cable.

PCA.1E.250.CTLC50Z = free socket with cable collet, 1E series, coaxial (50 Ω), outer shell in chrome-plated brass, PTFE insulator, C type collet for an up to 5.0 mm diameter cable and collet nut for fitting a bend relief.

ERA.1E.250.CTL = fixed socket, nut fixing, 1E series, coaxial (50 Ω), outer shell in chrome-plated brass, PTFE insulator.

Note: ¹⁾ for mixed contacts, add cable group to the part number.
²⁾ see unipole-multipole catalogue.

Part Section Showing Internal Components (mixed coax + LV)

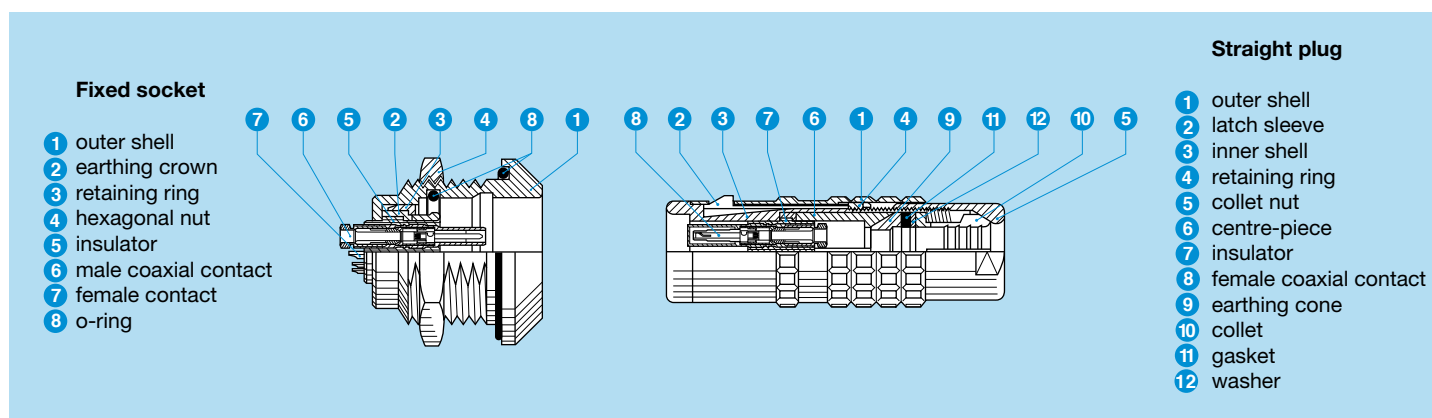

Insert configuration (S and E series)

Coaxial

| | | | Reference | Series | | Impedance (Ω) | ø A (mm) | Cable group | Cond. ø max | Dielectric ø maxi | Sheath ø | | VSWR (f=GHz) | Test voltage (kV rms) | Rated current (A) |
|------------------|--|--|-------------------------|----------|------------|---------------|----------|-------------|-------------|-------------------|---------------|---------------|----------------|-----------------------|-------------------|
| | | | | Standard | Watertight | | | | | | Maxi S series | Maxi E series | | | |
| 00 | | | 250¹⁾ | 00 | - | 50 | 0.7 | 1 to 9 | 1.05 | 3.05 | 5.5 | | 1.09 +0.11f | 2.1 | 4 |
| 0S 0E | | | 250 | 0S | 0E | 50 | 0.9 | 1-2 3-4 | 0.95 | 2.95 | 6.7 | 5.0 | 1.02 +0.25f | 3.0 | 6 |
| 1S 1E | | | 250 | 1S | 1E | 50 | 1.6 | 1-2 3-4 | 1.35 | 3.95 | 8.5 | 8.5 | 1.01 +0.23f | 3.0 | 12 |
| | | | 275 | 1S | 1E | 75 | 1.3 | 5-6-7 | 1.05 | 3.95 | 8.5 | 8.5 | 1.02 +0.08f | 2.4 | 10 |
| 2S 2E | | | 250 | 2S | 2E | 50 | 2.0 | 6-7 | 1.75 | 5.95 | 10.5 | 10.5 | 1.01 +0.95f | 3.0 | 15 |
| | | | 275 | 2S | 2E | 75 | 1.6 | 6-7 | 1.35 | 5.95 | 10.5 | 10.5 | 1.02 +0.03f | 1.5 | 12 |
| 3S 3E | | | 250 | 3S | 3E | 50 | 3.0 | 8 | 2.65 | 8.15 | 13.0 | 15.0 | 1.06 +0.5f | 3.0 | 26 |
| | | | 275 | 3S | 3E | 75 | 2.0 | 8 | 1.75 | 8.15 | 13.0 | 15.0 | 1.04 +0.05f | 2.7 | 15 |
| 4S 4E | | | 250 | 4S | 4E | 50 | 4.0 | 8-9 | 3.65 | 10.05 | 22.0 | 23.5 | 1.01 +1.9f | 2.1 | 36 |
| | | | 275 | 4S | 4E | 75 | 3.0 | 8-9-0 | 2.65 | 10.05 | 22.0 | 23.5 | 1.01 +0.12f | 1.8 | 26 |
| 5S | | | 250 | 5S | - | 50 | 5.0 | 9 | 5.15 | 17.45 | 30.0 | 30.0 | 1.02 +2.3f | 3.0 | 45 |

Note: ¹⁾ see NIM-CAMAC catalogue.

Triaxial

| | | | Reference | Series | | Impedance (Ω) | ø A (mm) | Cable group | Cond. ø max | Dielectric ø maxi | Sheath ø | | VSWR (f=GHz) | Test voltage (kV rms) (contact/screen) | Rated current (A) |
|------------------|--|--|------------------|----------|------------|---------------|----------|-------------|-------------|-------------------|---------------|---------------|----------------|---|-------------------|
| | | | | Standard | Watertight | | | | | | Maxi S series | Maxi E series | | | |
| 0S 0E | | | 650 | 0S | 0E | 50 | 0.9 | 1-2 | 0.75 | 2.95 | 6.7 | 5.0 | 1.03 +0.34f | 1.0 | 6 |
| | | | 1S 1E | 1S | 1E | 50 | 0.9 | 1-2-3 | 0.75 | 3.95 | 8.5 | 8.5 | 1.01 +0.17f | 1.0 | 6 |
| 2S 2E | | | 650 | 2S | 2E | 50 | 1.6 | 2-3-4 | 1.35 | 5.95 | 10.5 | 10.5 | 1.01 +0.3f | 1.5 | 12 |
| | | | 675 | 2S | 2E | 75 | 0.9 | 4-6 | 0.75 | 5.95 | 10.5 | 10.5 | 1.01 +0.07f | 1.5 | 6 |
| 3S 3E | | | 650 | 3S | 3E | 50 | 2.0 | 3-4-5 | 1.75 | 8.45 | 13.0 | 15.0 | 1.01 +0.27f | 2.4 | 15 |
| | | | 675 | 3S | 3E | 75 | 0.9 | 4-5 | 0.75 | 8.45 | 13.0 | 15.0 | 1.01 +0.05f | 1.8 | 6 |
| 4S 4E | | | 650 | 4S | 4E | 50 | 3.0 | 4-5 | 2.65 | 10.05 | 22.0 | 23.5 | 1.01 +0.38f | 2.7 | 26 |
| | | | 675 | 4S | 4E | 75 | 2.0 | 4-5-7 | 2.25 | 10.05 | 22.0 | 23.5 | 1.01 +0.14f | 2.2 | 15 |

Mixed: coax + LV, multi coax

| | | Reference | Series | | Coaxial | | | | | Low voltage | | | | |
|------------------------|--|------------|----------|------------|--------------------|------------------------|-------------------|--------------------|-------------|--------------------|---------------|-----------------------|----------------------|-------------------|
| | | | Standard | Watertight | Number of contacts | Impedance (Ω) | Rated current (A) | Type (see page 27) | Cable group | Number of contacts | ϕ A (mm) | Test voltage (kV rms) | Test voltage (kV dc) | Rated current (A) |
| 3S 3E | | 801 | 3S | 3E | 1 | 50 | 5 | A1 | 1-2-3 | 1 | 1.3 | 2.7 | 3.9 | 14 |
| | | 802 | 3S | 3E | 1 | 50 | 5 | A1 | 1-2-3 | 2 | 1.3 | 1.2 | 1.8 | 14 |
| | | 803 | 3S | 3E | 1 | 50 | 5 | A1 | 1-2-3 | 3 | 1.3 | 2.7 | 3.9 | 14 |
| | | 804 | 3S | 3E | 1 | 50 | 5 | A1 | 1-2-3 | 4 | 1.3 | 1.2 | 1.8 | 10 |
| | | 805 | 3S | 3E | 1 | 50 | 5 | A1 | 1-2-3 | 5 | 0.9 | 1.8 | 2.4 | 8 |
| | | 806 | 3S | 3E | 1 | 50 | 5 | A1 | 1-2-3 | 6 | 0.9 | 0.8 | 1.2 | 8 |
| | | 807 | 3S | 3E | 1 | 50 | 5 | A1 | 1-2-3 | 7 | 0.9 | 0.8 | 1.2 | 7 |
| 4S 4E | | 802 | 4S | 4E | 1 | 50 | 5 | A1 | 1-2-3 | 2 | 3.0 | 2.1 | 3.0 | 21 |
| | | 803 | 4S | 4E | 1 | 50 | 5 | A1 | 1-2-3 | 3 | 2.0 | 2.1 | 3.0 | 16 |
| | | 804 | 4S | 4E | 1 | 50 | 5 | A1 | 1-2-3 | 4 | 1.3 | 2.7 | 3.9 | 13 |
| | | 805 | 4S | 4E | 1 | 50 | 5 | A1 | 1-2-3 | 5 | 1.3 | 2.1 | 3.0 | 11 |
| | | 806 | 4S | 4E | 1 | 50 | 5 | A1 | 1-2-3 | 6 | 1.3 | 2.1 | 3.0 | 9 |
| | | 807 | 4S | 4E | 1 | 50 | 5 | A1 | 1-2-3 | 7 | 1.3 | 2.1 | 3.0 | 8 |
| | | 809 | 4S | 4E | 1 | 50 | 5 | A1 | 1-2-3 | 9 | 0.9 | 2.1 | 3.0 | 7 |
| | | 810 | 4S | 4E | 1 | 50 | 5 | A1 | 1-2-3 | 10 | 0.9 | 2.1 | 3.0 | 7 |
| | | 812 | 4S | 4E | 1 | 50 | 5 | A1 | 1-2-3 | 12 | 0.9 | 2.1 | 3.0 | 7 |
| | | 202 | 4S | 4E | 2 | 50 | 5 | A1 | 1-2-3 | - | - | - | - | - |
| | | 832 | 4S | 4E | 2 | 50 | 5 | A1 | 1-2-3 | 2 | 1.3 | 2.1 | 3.0 | 13 |

Mixed: coax + LV, multi coax

| | | Reference | Series | | Coaxial | | | | Low voltage | | | | | | |
|--|--|--------------------------|------------|------------|--------------------|------------------------|-------------------|--------------------|--------------|--------------------|---------------|-----------------------|----------------------|-------------------|----|
| | | | Standard | Watertight | Number of contacts | Impedance (Ω) | Rated current (A) | Type (see page 27) | Cable group | Number of contacts | ϕ A (mm) | Test voltage (kV rms) | Test voltage (kV dc) | Rated current (A) | |
| <div style="text-align: center;"> </div> | | | 834 | 4S | 4E | 2 | 50 | 5 | A1 | 1-2-3 | 4 | 1.3 | 2.1 | 3.0 | 13 |
| | | | 836 | 4S | 4E | 2 | 50 | 5 | A1 | 1-2-3 | 6 | 0.9 | 1.8 | 2.4 | 7 |
| | | | 838 | 4S | 4E | 2 | 50 | 5 | A1 | 1-2-3 | 8 | 0.9 | 1.8 | 2.4 | 7 |
| | | | 842 | 4S | 4E | 2 | 50 | 5 | A1 | 1-2-3 | 12 | 0.9 | 1.8 | 2.4 | 7 |
| <div style="text-align: center;"> </div> | | 803 | - | 5E | 1 | 50 | 12 | A | 4-6 | 3 | 3.0 | 3.0 | 4.2 | 25 | |
| | | 804 | 5S | - | 1 | 50 | 6 | A0 | 1-3-4 | 4 | 3.0 | 2.1 | 3.0 | 22 | |
| | | 804 | - | 5E | 1 | 75 | 7 | A | 3-4-5 | 4 | 3.0 | 2.1 | 3.0 | 22 | |
| | | 810 | 5S | 5E | 1 | 50 | 5 | A1 | 1-2-3 | 10 | 1.6 | 1.8 | 2.4 | 11 | |
| | | 232 | 5S | - | 2 | 50 | 6 | A0 | 1-3-4 | - | - | - | - | - | |
| | | 282 292 | 5S | 5E | 2 | 50 75 | 12 7 | A | 4-6 3-4-5 | - | - | - | - | - | |
| | | 832 | 5S | 5E | 2 | 50 | 6 | A0 | 1-3-4 | 2 | 2.0 | 2.1 | 3.0 | 18 | |

Mixed: coax + LV, multi coax

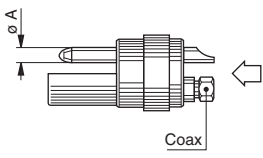
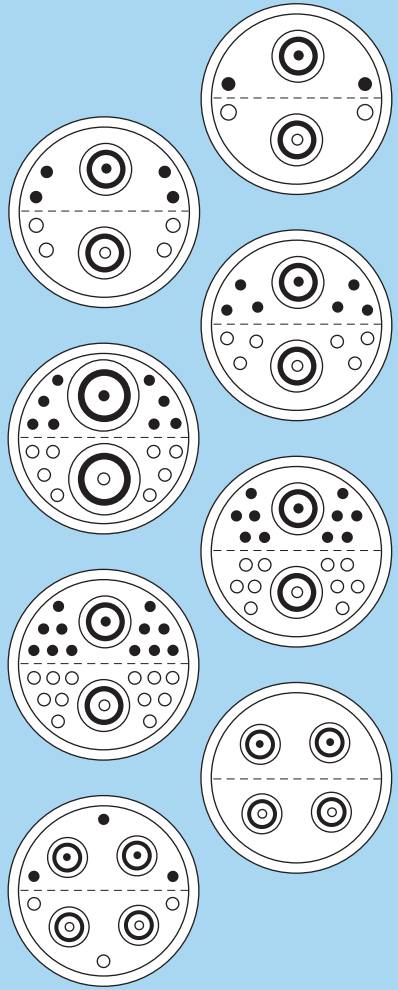
| | Reference | Series | | Coaxial | | | | Low voltage | | | | | |
|--|------------|----------|------------|--------------------|------------------------|-------------------|--------------------|-------------|--------------------|---------------|-----------------------|----------------------|-------------------|
| | | Standard | Watertight | Number of contacts | Impedance (Ω) | Rated current (A) | Type (see page 27) | Cable group | Number of contacts | ϕ A (mm) | Test voltage (kV rms) | Test voltage (kV dc) | Rated current (A) |
| <div style="border: 1px solid black; padding: 2px; display: inline-block; margin-bottom: 5px;">5S 5E</div>   | 834 | 5S | 5E | 2 | 50 | 6 | A0 | 1-3-4 | 4 | 2.0 | 2.1 | 3.0 | 18 |
| | 838 | 5S | - | 2 | 50 | 6 | A0 | 1-3-4 | 8 | 1.6 | 1.8 | 2.4 | 12 |
| | 842 | 5S | 5E | 2 | 50 | 6 | A0 | 1-3-4 | 12 | 1.3 | 1.8 | 2.4 | 9 |
| | 846 | - | 5E | 2 | 75 | 7 | A | 3-4-5 | 16 | 1.3 | 0.8 | 1.2 | 8 |
| | 850 | 5S | - | 2 | 50 | 6 | A0 | 1-3-4 | 20 | 1.3 | 0.8 | 1.2 | 7 |
| | 854 | 5S | - | 2 | 50 | 6 | A0 | 1-3-4 | 24 | 1.3 | 0.8 | 1.2 | 6 |
| | 234 | 5S | 5E | 4 | 50 | 5 | A1 | 1-2-3 | - | - | - | - | - |
| | 876 | 5S | 5E | 4 | 50 | 5 | A1 | 1-2-3 | 6 | 1.3 | 0.8 | 1.2 | 6 |

Mixed: coax + LV, multi coax

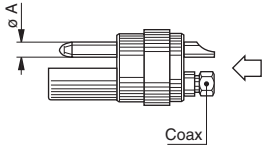
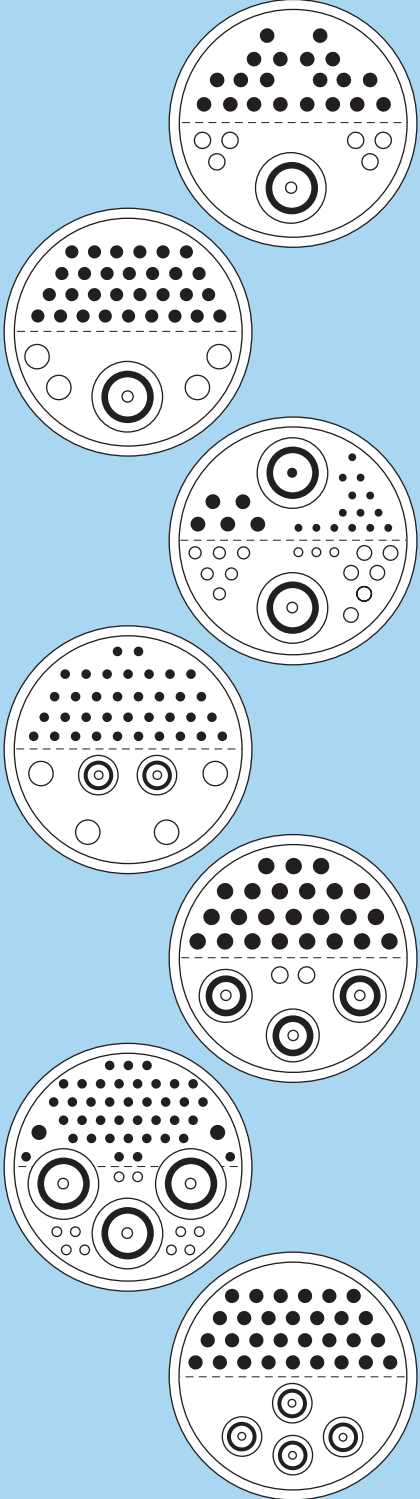
| | Reference | Coaxial | | | | | Low voltage | | | | |
|--|------------|--------------------|------------------------|-------------------|--------------------|-------------|--------------------|--------------------------|--------------------------|--------------------------|-------------------|
| | | Number of contacts | Impedance (Ω) | Rated current (A) | Type (see page 27) | Cable group | Number of contacts | ϕ A (mm) | Test voltage (kV rms) | Test voltage (kV dc) | Rated current (A) |
| <div style="border: 1px solid black; padding: 2px; display: inline-block; margin-bottom: 10px;">6S</div>   | 826 | 1 | 75 | 7 | A | 3-4-5 | 26 | 2.0 | 1.5 | 2.1 | 7 |
| | 830 | 1 | 75 | 7 | A | 3-4-5 | 4 30 | 3.0 1.6 | 1.5 1.5 | 2.1 2.1 | 14 5 |
| | 858 | 2 | 75 | 7 | A | 3-4-5 | 6 6 5 17 | 1.3 1.6 2.0 1.9 | 1.2 1.2 1.2 1.2 | 1.8 1.8 1.8 1.8 | 4 5 10 2 |
| | 859 | 2 | 50 | 5 | A1 | 1-2-3 | 36 4 | 1.3 3.0 | 1.2 1.2 | 1.8 1.8 | 4 14 |
| | 866 | 3 | 50 | 6 | A0 | 1-3-4 | 26 | 2.0 | 1.5 | 2.1 | 7 |
| | 867 | 3 | 75 | 7 | A | 3-4-5 | 49 2 | 0.9 1.6 | 1.2 1.2 | 1.8 1.8 | 2 5 |
| | 883 | 4 | 50 | 4 | A1 | 1-2-3 | 30 | 1.6 | 1.5 | 2.1 | 5 |

Mixed: coax + LV, multi coax

| | Reference | Coaxial | | | | | Low voltage | | | | |
|---|------------|--------------------|------------------------|-------------------|--------------------|--------------|--------------------|---------------|-----------------------|----------------------|-------------------|
| | | Number of contacts | Impedance (Ω) | Rated current (A) | Type (see page 27) | Cable group | Number of contacts | ϕ A (mm) | Test voltage (kV rms) | Test voltage (kV dc) | Rated current (A) |
| <div style="border: 1px solid black; padding: 2px; width: fit-content; margin-bottom: 10px;">6S</div> | 284 294 | 4 | 50 75 | 12 7 | A | 4-6 3-4-5 | - | - | - | - | |
| | 882 | 4 | 75 | 7 | A | 3-4-5 | 26 | 0.9 | 0.8 | 1.2 | 2 |
| | 887 | 1 4 | 50 50 | 26 5 | A3 A1 | 7 3 } 9 | 7 | 2.0 | 1.5 | 2.1 | 10 |
| | 890 | 6 | 50 | 5 | A1 | 1-2-3 | 4 | 4.0 | 1.5 | 2.1 | 16 |
| | 893 | 6 | 50 | 5 | A1 | 1-2-3 | 20 | 1.6 | 1.5 | 2.1 | 5 |
| | 238 | 8 | 50 | 6 | A0 | 1-3-4 | - | - | - | - | - |
| | 899 | 8 | 50 | 5 | A1 | 1-2-3 | 20 | 1.6 | 1.5 | 2.1 | 5 |

Mixed: coax + LV, multi coax

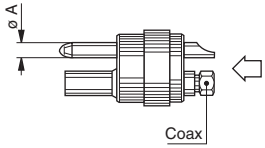
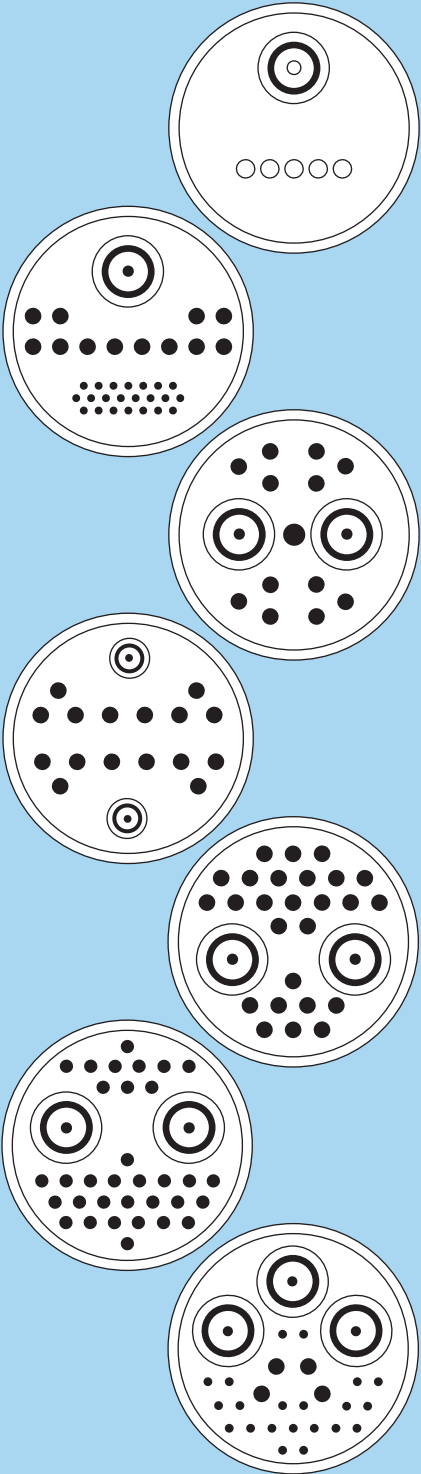
| | Reference | Coaxial | | | | | Low voltage | | | | |
|--|-------------------|--------------------|------------------------|-------------------|--------------------|-------------|--------------------|---------------|-----------------------|----------------------|-------------------|
| | | Number of contacts | Impedance (Ω) | Rated current (A) | Type (see page 27) | Cable group | Number of contacts | ϕ A (mm) | Test voltage (kV rms) | Test voltage (kV dc) | Rated current (A) |
| <div style="border: 1px solid black; padding: 2px; width: fit-content; margin-bottom: 10px;">6E</div>   | 805 ¹⁾ | 1 | 75 | 7 | A | 3-4-5 | 5 | 2.0 | 1.5 | 2.1 | 10 |
| | 831 | 1 | 75 | 7 | A | 3-4-5 | 24 12 | 0.9 2.0 | 0.8 1.5 | 1.2 2.1 | 2 10 |
| | 843 | 2 | 75 | 7 | A | 3-4-5 | 12 1 | 2.0 3.0 | 1.5 1.5 | 2.1 2.1 | 10 14 |
| | 847 | 2 | 50 | 5 | A1 | 1-2-3 | 17 | 2.0 | 1.5 | 2.1 | 10 |
| | 856 | 2 | 75 | 7 | A | 3-4-5 | 26 | 2.0 | 1.5 | 2.1 | 7 |
| | 857 | 2 | 75 | 7 | A | 3-4-5 | 33 | 1.3 | 1.2 | 1.8 | 4 |
| | 865 | 3 | 75 | 7 | A | 3-4-5 | 21 4 | 1.3 2.0 | 1.2 1.2 | 1.8 1.8 | 4 10 |

Note: ¹⁾ The type 6E.805 is delivered with female contacts in the plug.

Mixed: coax + LV, multi coax

| | Reference | Coaxial | | | | | Low voltage | | | | |
|---|-----------|--------------------|------------------------|-------------------|--------------------|-------------|--------------------|---------------|-----------------------|----------------------|-------------------|
| | | Number of contacts | Impedance (Ω) | Rated current (A) | Type (see page 27) | Cable group | Number of contacts | ϕ A (mm) | Test voltage (kV rms) | Test voltage (kV dc) | Rated current (A) |
| <div style="border: 1px solid black; padding: 5px; width: fit-content; margin-bottom: 10px;">6E</div> | 866 | 3 | 75 | 7 | A | 3-4-5 | 26 | 1.3 | 1.2 | 1.8 | 4 |
| | 880 | 4 | 50 | 5 | A1 | 1-2-3 | 20 | 1.3 | 1.2 | 1.8 | 4 |
| | 882 | 4 | 75 | 7 | A | 3-4-5 | 20 | 0.9 | 0.8 | 1.2 | 2 |
| | 884 | 4 | 75 | 7 | A | 3-4-5 | 38 | 0.9 | 0.8 | 1.2 | 2 |
| | 235 | 5 | 50 | 6 | A0 | 1-3-4 | - | - | - | - | - |
| | 899 | 8 | 50 | 5 | A1 | 1-2-3 | 20 | 1.6 | 1.5 | 2.1 | 5 |

Mixed: coax + LV + HV

| | | | | | | | | | | | |
|------------------------|-----------|--------------------|------------------------|-------------------|--------------------|-------------|--------------------|----------------------|--------------------|----------------------|-----|
| | Reference | Coax | | | | | Low voltage (LV) | | High voltage (HV) | | |
| | | Number of contacts | Impedance (Ω) | Rated current (A) | Type (see page 27) | Cable group | Number of contacts | $\varnothing A$ (mm) | Number of contacts | $\varnothing A$ (mm) | |
| 4S 4E | | 934 | 1 | 50 | 5 | A1 | 1-2-3 | 4 | 0.9 | 1 | 2.0 |

Collet nut for fitting a bend relief (S and E series)

C type collets for S series

| | Clamping | Coax cable groupe | | |
|----------|-------------|-------------------|------|------|
| | | 1 | 2 | 3 |
| S | C42Z | C41Z | C42Z | C43Z |
| | C57Z | C51Z | C52Z | C53Z |
| | C72Z | C71Z | C72Z | C73Z |
| | C87Z | C81Z | C82Z | C83Z |
| | C97Z | C91Z | C92Z | C93Z |
| | C11Z | C11Z | C12Z | C13Z |
| | C12Z | C21Z | C22Z | C23Z |

C type collets for E series

| | Clamping | Coax cable groupe | | |
|----------|-------------|-------------------|------|------|
| | | 1 | 2 | 3 |
| E | C50Z | C51Z | C52Z | C53Z |
| | C55Z | C56Z | C57Z | C58Z |
| | C80Z | C81Z | C82Z | C83Z |
| | C85Z | C86Z | C87Z | C88Z |
| | C90Z | C91Z | C92Z | C93Z |
| | C95Z | C96Z | C97Z | C98Z |
| | C10Z | C01Z | C02Z | C03Z |
| | C11Z | C11Z | C12Z | C13Z |
| | C12Z | C21Z | C22Z | C23Z |
| | C13Z | C31Z | C32Z | C33Z |
| | C14Z | C41Z | C42Z | C43Z |

Note: see unipole-multipole catalogue for others available collets.

Coaxial contacts for S and E series

| Type | Impedance (Ω) | ø A (mm) | Cond. fixing | Screen fixing | Cable group | Cond. ø maxi | Dielectric ø maxi | Sheath ø | | VSWR (f=GHz) | Test voltage (kV rms) | Rated current (A) |
|------|---------------|----------|--------------|---------------|-------------|--------------|-------------------|----------|------|-----------------|-----------------------|-------------------|
| | | | | | | | | Mini | Maxi | | | |
| A1 | 50 | 0.7 | solder | collet | 1 | 0.55 | 1.90 | 2.5 | 3.0 | 1.01 +0.127f | 0.9 | 5 |
| | | | | | 2 | 0.55 | 1.90 | 1.7 | 2.1 | | | |
| | | | | | 3 | 0.55 | 1.90 | 2.2 | 2.6 | | | |
| A0 | 50 | 0.9 | solder | collet | 2 | 0.95 | 2.95 | 1.7 | 2.1 | 1.06 +0.1f | 3.0 | 6 |
| | | | | | 3 | 0.95 | 2.95 | 2.7 | 3.1 | | | |
| | | | | | 4 | 0.95 | 2.95 | 3.3 | 4.1 | | | |
| A | 50 | 1.6 | solder | collet | 4 | 1.35 | 3.95 | 3.3 | 4.1 | 1.01 +0.146f | 1.8 | 12 |
| | | | | | 6 | 1.35 | 3.95 | 4.3 | 5.1 | | | |
| | 75 | 1.3 | solder | collet | 3 | 1.05 | 3.95 | 2.2 | 2.6 | 1.01 +0.19f | 2.4 | 7 |
| 4 | 1.05 | 3.95 | 3.3 | 4.1 | | | | | | | | |
| 5 | 1.05 | 3.95 | 5.3 | 6.1 | | | | | | | | |
| A3 | 50 | 3.0 | solder | collet | 7 | 2.60 | 8.10 | 10.0 | 10.6 | 1.06 +0.5f | 3.0 | 15 |

Recommended coaxial cables for 00 Series (page 18)

| | LEMO cable Part Number | Type | LEMO cable group | Impedance (Ω) | Conductor ø (mm) | Dielectric ø (mm) | Screen ø (mm) | Sheath ø (mm) |
|--------------|------------------------|--------------------------|------------------|---------------|------------------|-------------------|---------------|---------------|
| Standard | CCX.50.RG5.8CU50N | RG 58 C/U | 6 | 50 ± 2 | 0.90 | 2.95 | 3.60 | 5.00 |
| | CCX.50.RG1.42BU50M | RG 142 B/U | 7 | 50 ± 2 | 0.95 | 2.95 | 3.53 / 4.30 | 5.00 |
| | CCX.50.RG1.74U25N | RG 174 /U | 3 | 50 ± 2 | 0.48 | 1.50 | 2.00 | 2.55 |
| | CCX.50.RG1.74AU27N | RG 174 A/U | 3 | 50 ± 2 | 0.48 | 1.50 | 2.00 | 2.80 |
| | CCX.50.RG1.78BU18M | RG 178 B/U | 1 | 50 ± 2 | 0.30 | 0.84 | 1.30 | 1.80 |
| | CCX.75.RG1.79BU26M | RG 179 B/U | 2 | 75 ± 3 | 0.30 | 1.50 | 2.00 | 2.50 |
| | CCX.75.RG1.87AU26B | RG 187 A/U | 2 | 75 ± 3 | 0.30 | 1.50 | 2.00 | 2.60 |
| | CCX.50.RG1.88AU24B | RG 188 A/U | 4 | 50 ± 2 | 0.54 | 1.50 | 2.00 | 2.60 |
| | CCX.95.RG1.95AU37B | RG 195 A/U | 5 | 95 ± 5 | 0.30 | 2.52 | 3.10 | 3.70 |
| | CCX.50.RG1.96AU20B | RG 196 A/U | 1 | 50 ± 2 | 0.30 | 0.84 | 1.30 | 1.95 |
| | CCX.50.RG3.16U26M | RG 316 /U | 4 | 50 ± 2 | 0.54 | 1.50 | 2.10 | 2.60 |
| Non standard | | Huber+Suhner, G02232D-60 | 8 | 50 ± 2 | 0.50 | 1.50 | 1.95 / 2.40 | 3.10 |
| | | Huber+Suhner, K01152-07 | 9 | 50 ± 5 | 0.19 | 0.52 | 0.90 | 1.25 |
| | | Storm, 421-099 | 8 | 50 ± 2 | 0.50 | 1.52 | 2.00 / 2.50 | 3.05 |

Note: for more details on cable properties, see NIM-CAMAC catalogue.

Recommended triaxial cables for 00 Series (page 13)

| Standard | LEMO cable Part Number | Type | Impedance (Ω) | Conductor ø (mm) | Dielectric ø (mm) | Screen 1 ø (mm) | Screen 2 ø (mm) | Sheath ø (mm) |
|----------|------------------------|------------------------|---------------|------------------|-------------------|-----------------|-----------------|---------------|
| | | RGT 316 | 50 ± 2 | 0.51 | 1.50 | 2.05 | 3.15 | 3.60 |
| | | RGT 403 | 50 ± 2 | 0.30 | 0.84 | 1.30 | 2.35 | 2.95 |
| | 017 410 LEDE | RGT 174 | 50 ± 2 | 0.48 | 1.55 | 1.90 | 2.90 | 3.90 |
| | 017 820 LEDE | RGT 178 | 50 ± 2 | 0.30 | 0.90 | 1.37 | 2.30 | 2.80 |
| | | Huber + Suhner G 02332 | 50 ± 2 | 0.49 | 1.50 | 2.00 | 3.05 | 4.25 |
| | | SMT 50 | 50 ± 2 | 0.16 | 0.52 | 0.85 | 1.35 | 1.60 |

Recommended coaxial cables for S and E Series (page 18)

| LEMO cable Part Number | Type | LEMO cable group | Impedance (Ω) | Conductor ø (mm) | Dielectric ø (mm) | Screen ø (mm) | Sheath ø (mm) |
|---------------------------|-----------------------|------------------|---------------|------------------|-------------------|---------------|---------------|
| 311 100 LEDE | RG 11 A/U | 8 | 75 ± 2 | 1.17 | 7.25 | 8.15 | 10.10 |
| | RG 12 A/U | 0 | 75 ± 3 | 1.20 | 7.25 | 8.20 | 11.80 |
| CCX.50.RG5.8CU50N | RG 58 C/U | 6 | 50 ± 2 | 0.90 | 2.95 | 3.60 | 5.00 |
| CCX.50.RG5.9BU62N | RG 59 B/U | 7 | 75 ± 3 | 0.60 | 3.70 | 4.50 | 6.20 |
| | RG 115 A/U | 8 | 50 ± 2 | 2.25 | 6.50 | 8.00 | 10.50 |
| | RG 122 /U | 4 | 50 ± 2 | 0.80 | 2.50 | 3.20 | 4.10 |
| CCX.50.RG1.42BU50M | RG 142 B/U | 6 | 50 ± 2 | 0.95 | 2.95 | 4.30 | 5.00 |
| | RG 144 /U | 8 | 75 ± 3 | 1.35 | 7.25 | 8.00 | 10.40 |
| | RG 165 /U | 8 | 50 ± 2 | 2.46 | 7.25 | 8.00 | 10.40 |
| CCX.50.RG1.74AU27N | RG 174 A/U | 3 | 50 ± 2 | 0.48 | 1.50 | 2.00 | 2.80 |
| CCX.50.RG1.78BU18M | RG 178 B/U | 1 | 50 ± 2 | 0.30 | 0.84 | 1.30 | 1.80 |
| CCX.75.RG1.79BU26M | RG 179 B/U | 5 | 75 ± 3 | 0.30 | 1.50 | 2.00 | 2.50 |
| CCX.75.RG1.87AU26M | RG 187 A/U | 5 | 75 ± 3 | 0.30 | 1.50 | 2.00 | 2.60 |
| CCX.50.RG1.88AU26B | RG 188 A/U | 2 | 50 ± 2 | 0.54 | 1.50 | 2.00 | 2.60 |
| CCX.50.RG1.96AU20B | RG 196 A/U | 1 | 50 ± 2 | 0.30 | 0.84 | 1.30 | 1.95 |
| 213 000 LEDE | RG 213 /U | 8 | 50 ± 2 | 2.25 | 7.25 | 8.20 | 10.30 |
| | RG 214 /U | 9 | 50 ± 2 | 2.25 | 7.25 | 8.80 | 10.80 |
| | RG 216 /U | 9 | 75 ± 3 | 1.20 | 7.25 | 8.80 | 10.80 |
| | RG 223 /U | 7 | 50 ± 2 | 0.89 | 2.95 | 4.30 | 5.40 |
| | RG 225 /U | 9 | 50 ± 2 | 2.40 | 7.25 | 8.80 | 10.90 |
| | RG 302 /U | 6 | 75 ± 3 | 0.64 | 3.70 | 4.40 | 5.10 |
| CCX.50.RG3.16U26M | RG 316 B/U | 2 | 50 ± 2 | 0.60 | 1.60 | 2.10 | 2.80 |
| | RG 400 /U | 6 | 50 ± 2 | 1.00 | 2.98 | 4.20 | 5.00 |
| | HF-2114 Dätwyler | 3 | 50 ± 2 | 0.48 | 1.30 | 1.90 | 2.70 |
| | HF-5408/1 Dätwyler | 7 | 75 ± 3 | 0.60 | 3.80 | | 5.60 |
| | 2YCCY 0.4/2.5 Siemens | 6 | 75 ± 2 | 0.40 | 2.50 | 3.70 | 4.50 |

Recommended coaxial cables for mixed coax, multi coax for S and E Series (pages 20 to 26)

| LEMO cable Part Number | Type | LEMO cable group | Impedance (Ω) | Conductor ø (mm) | Dielectric ø (mm) | Screen ø (mm) | Sheath ø (mm) |
|----------------------------|------------|------------------|---------------|------------------|-------------------|---------------|---------------|
| CCX.50.RG5.8CU50N | RG 58 C/U | 6 | 50 ± 2 | 0.90 | 2.95 | 3.60 | 5.00 |
| CCX.50.RG5.9BU62N | RG 59 B/U | 5 | 75 ± 3 | 0.60 | 3.70 | 4.50 | 6.20 |
| | RG 122 /U | 4 | 50 ± 2 | 0.80 | 2.50 | 3.20 | 4.10 |
| CCX.50.RG1.42BU50M | RG 142 B/U | 6 | 50 ± 2 | 0.95 | 2.95 | 4.30 | 5.00 |
| CCX.50.RG1.74.AU27N | RG 174 A/U | 1 | 50 ± 2 | 0.48 | 1.50 | 2.00 | 2.80 |
| CCX.50.RG1.78BU18M | RG 178 B/U | 2 | 50 ± 2 | 0.30 | 0.84 | 1.30 | 1.80 |
| CCX.75.RG1.79BU26M | RG 179 B/U | 3 | 75 ± 3 | 0.30 | 1.50 | 2.00 | 2.50 |
| CCX.75.RG1.87AU26M | RG 187 A/U | 3 | 75 ± 3 | 0.30 | 1.50 | 2.00 | 2.60 |
| CCX.50.RG1.88AU26B | RG 188 A/U | 1 | 50 ± 2 | 0.54 | 1.50 | 2.00 | 2.60 |
| CCX.50.RG1.96AU20B | RG 196 A/U | 2 | 50 ± 2 | 0.30 | 0.84 | 1.30 | 1.95 |
| 213 000 LEDE | RG 213 /U | 7 | 50 ± 2 | 2.25 | 7.25 | 8.20 | 10.30 |
| | RG 223 /U | 6 | 50 ± 2 | 0.89 | 2.95 | 4.30 | 5.40 |
| | RG 302 /U | 5 | 75 ± 3 | 0.64 | 3.70 | 4.40 | 5.10 |
| CCX.50.RG3.16U26M | RG 316 /U | 1 | 50 ± 2 | 0.54 | 1.50 | 2.10 | 2.60 |
| | RG 400 /U | 5 | 50 ± 2 | 1.00 | 2.98 | 4.20 | 5.00 |

Note: the cable group number corresponding to the chosen cable must be written in the variant position, see pages 15 and 17.

Recommended triaxial cables for S and E Series (page 19)

| LEMO cable Part Number | Type | LEMO cable group | Impedance (Ω) | Conductor ø (mm) | Dielectric ø (mm) | Screen 1 ø (mm) | Screen 2 ø (mm) | Sheath ø (mm) |
|---------------------------|---------------------------|------------------|---------------|------------------|-------------------|-----------------|-----------------|---------------|
| CTR.50.RG1.78BU29M | RGT 178 | 1 | 50 ± 2 | 0.30 | 0.90 | 1.37 | 2.30 | 2.80 |
| CTR.50.RG1.74AU39N | RGT 174 | 2 | 50 ± 2 | 0.48 | 1.55 | 1.90 | 2.90 | 3.90 |
| | 9222 Belden ¹⁾ | 3 | 50 ± 2 | 0.94 | 2.90 | 3.50 | 5.20 | 6.10 |
| | HF-2318 Dätwyler | 5 | 50 ± 2 | 1.60 | 4.80 | – | – | 10.20 |
| | 8215 Belden | 4 | 75 ± 3 | 0.72 | 4.55 | – | – | 8.43 |
| | 8232A Belden | 4 | 75 ± 3 | 0.80 | 3.70 | – | – | 8.00 |
| | HF-2426 Dätwyler | 4 | 75 ± 3 | 0.60 | 3.70 | – | – | 8.00 |
| | RGT 179 | 6 | 75 ± 3 | 0.30 | 1.60 | 2.10 | 3.10 | 3.60 |
| 375 029 LEDE | Triax 8 Nokia | 4 | 75 ± 3 | 1.00 | 4.50 | 5.20 | 7.20 | 8.50 |
| | 9267 Belden | 5 | 75 ± 3 | 0.84 | 3.70 | – | – | 9.20 |
| 466 140 LEDE | Triax 11 Nokia | 7 | 75 ± 3 | 1.40 | 6.50 | 7.20 | 9.40 | 10.90 |
| | 8233A Belden | 7 | 75 ± 3 | 1.60 | 7.30 | – | – | 12.10 |

Note: ¹⁾ when used with 1S.650 / 1E.650, please request large contact bucket («W» type).

Product safety notice

PLEASE READ AND FOLLOW ALL INSTRUCTIONS CAREFULLY AND CONSULT ALL RELEVANT NATIONAL AND INTERNATIONAL SAFETY REGULATIONS FOR YOUR APPLICATION. IMPROPER HANDLING, CABLE ASSEMBLY, OR WRONG USE OF CONNECTORS CAN RESULT IN HAZARDOUS SITUATIONS.

1. SHOCK AND FIRE HAZARD

Incorrect wiring, the use of damaged components, presence of foreign objects (such as metal debris), and / or residue (such as cleaning fluids), can result in short circuits, overheating, and / or risk of electric shock. Mated components should never be disconnected while live as this may result in an exposed electric arc and local overheating, resulting in possible damage to components.

2. HANDLING

Connectors and their components should be visually inspected for damage prior to installation and assembly. Suspect components should be rejected or returned to the factory for verification. Connector assembly and installation should only be carried out by properly trained personnel. Proper tools must be used during installation and / or assembly in order to obtain safe and reliable performance.

3. USE

Connectors with exposed contacts should never be live (or on the current supply side of a circuit). Under general conditions voltages above 30 VAC and 42 VDC are considered hazardous and proper measures should be taken to eliminate all risk of transmission of such voltages to any exposed metal part of the connector.

4. TEST AND OPERATING VOLTAGES

The maximum admissible operating voltage depends upon the national or international standards in force for the application in question. Air and creepage distances impact the operating voltage; reference values are indicated in the catalog however these may be influenced by PC board design and / or wiring harnesses. The test voltage indicated in the catalog is 75% of the mean breakdown voltage; the test is applied at 500 V/s and the test duration is 1 minute.

5. CE MARKING

CE marking  means that the appliance or equipment bearing it complies with the protection requirements of one or several European safety directives.

CE marking  applies to complete products or equipment, **but not to electromechanical components, such as connectors.**

6. PRODUCT IMPROVEMENTS

The LEMO Group reserves the right to modify and improve to our products or specifications without providing prior notification.

7. **WARNING (Prop 65 State of California)**

Proposition 65 requires businesses to provide warnings to Californians about significant exposures to chemicals that cause cancer, birth defects or other reproductive harm. LEMO products are exempt from proposition 65 warnings because they are manufactured, marketed, and sold solely for commercial and industrial use. For further information, please visit <https://www.lemo.com/quality/LEMO-Prop-65-compliance-declaration.pdf>.

Disclaimers

LEMO works constantly to improve the quality of its products; the information and illustrations figuring in this document may therefore vary and are not binding. In any case, LEMO makes no specific warranty of merchantability, fitness for a particular purpose, third party components as such or included in assembly, non-infringement, title, accuracy, completeness, or security. The user is fully responsible for his products and applications using LEMO component.

In no event shall LEMO, its affiliates, officers, agents or employees be liable for any incidental, indirect, special or consequential damages in connection with the products or services provided by LEMO, including (without limitation) loss of profits or revenues, interruption of business, loss of use of the products or any associated equipment, materials, components or products, damages to associated equipment or in combination with other components, materials.

Reproduction of significant portions of LEMO information in LEMO data books or data sheets is permissible only if reproduction is without alteration and is accompanied by all associated warranties, conditions, limitations, and notices. LEMO is not responsible or liable for such altered documentation. Information of third parties may be subject to additional restrictions.

No reproduction or use without express permission of editorial or pictorial content, in any manner.
LEMO SA reserves the right to modify and improve specifications, at all times, without any notification.

LEMO HEADQUARTERS

SWITZERLAND

LEMO SA

Chemin des Champs-Courbes 28 - P.O. Box 194 - CH-1024 Ecublens
Tel. (+41 21) 695 16 00 - Fax (+41 21) 695 16 02 - e-mail: info@lemo.com

LEMO SUBSIDIARIES

AUSTRIA

LEMO Elektronik GesmbH

Lemböckgasse 49/E6-3
1230 Wien
Tel: (+43 1) 914 23 20 0
Fax: (+43 1) 914 23 20 11
salesAT@lemo.at

BRAZIL

LEMO Latin America Ltda

Av. José Rocha Bonfim,
214 Salas 224 / 225
Condomínio Praça Capital
Ed. Chicago
Campinas / SP - Brasil 13080-650
Tel: +55 (11) 98689 4736
info-la@lemo.com

CANADA

LEMO Canada Inc

44 East Beaver Creek Road, unit 20
Richmond Hill, Ontario L4B 1G8
Tel: (+1 905) 889 56 78
Fax: (+1 905) 889 49 70
info-canada@lemo.com

CHINA / HONG KONG

LEMO Electronics (Shanghai) Co., Ltd

First Floor, Block E,
18 Jindian Road, Pudong
Shanghai, China, 201206
Tel: (+86 21) 5899 7721
Fax: (+86 21) 5899 7727
cn.sales@lemo.com

DENMARK

LEMO Denmark A/S

Mandal Allé 16A
5500 Middelfart
Tel: (+45) 45 20 44 00
Fax: (+45) 45 20 44 01
info-dk@lemo.com

FRANCE

LEMO France Sàrl

24/28 Avenue Graham Bell
Bâtiment Balthus 4
Bussy Saint Georges
77607 Marne la Vallée Cedex 3
Tel: (+33 1) 60 94 60 94
Fax: (+33 1) 60 94 60 90
info-fr@lemo.com

GERMANY

LEMO Elektronik GmbH

Hanns-Schwindt-Str. 6
81829 München
Tel: (+49 89) 42 77 03
Fax: (+49 89) 420 21 92
info@lemo.de

HUNGARY

REDEL Elektronika Kft

Nagysándor József u. 6-12
1201 Budapest
Tel: (+36 1) 421 47 10
Fax: (+36 1) 421 47 57
info-hu@lemo.com

ITALY

LEMO Italia srl

Viale Lunigiana 25
20125 Milano
Tel: (+39 02) 66 71 10 46
Fax: (+39 02) 37 90 80 46
sales.it@lemo.com

JAPAN

LEMO Japan Ltd

2-7-22, Mita,
Minato-ku, Tokyo, 108-0073
Tel: (+81 3) 54 46 55 10
Fax: (+81 3) 54 46 55 11
info-jp@lemo.com

MIDDLE EAST

LEMO Middle East Connectors LLC

Concorde Tower 6th Floor,
Dubai Media City, P.O. Box 126732
Dubai, United Arab Emirates
Tel: +971 55 222 36 77
info-me@lemo.com

NETHERLANDS / BELGIUM

LEMO Connectors Nederland B.V.

Jacques Meuwissenweg 6
2031 AD Haarlem
Tel: +31 23 206 07 01
info-nl@lemo.com

NORWAY / ICELAND

LEMO Norway A/S

Soerumsandvegen 69,
1920 Soerumsand
Tel: (+47) 22 91 70 40
Fax: (+47) 22 91 70 41
info-no@lemo.com

SINGAPORE

LEMO Asia Pte Ltd

4 Leng Kee Road,
#06-09 SiS Building
Singapore 159088
Tel: (+65) 6476 0672
Fax: (+65) 6474 0672
sg.sales@lemo.com

SPAIN / PORTUGAL

IBERLEMO SAU

Brasil, 45, 08402 Granollers
Barcelona
Tel: (+34 93) 860 44 20
Fax: (+34 93) 879 10 77
info-es@lemo.com

SWEDEN / FINLAND

LEMO Nordic AB

Gunnebogatan 30, Box 8201
163 08 Spånga
Tel: (+46 8) 635 60 60
Fax: (+46 8) 635 60 61
info-se@lemo.com

SWITZERLAND

LEMO Verkauf AG

Grundstrasse 22 B, 6343 Rotkreuz
Tel: (+41 41) 790 49 40
ch.sales@lemo.com

UNITED KINGDOM

LEMO UK Ltd

12-20 North Street, Worthing,
West Sussex, BN11 1DU
Tel: (+44 1903) 23 45 43
lemouk@lemo.com

USA

LEMO USA Inc

P.O. Box 2408
Rohnert Park, CA 94927-2408
Tel: (+1 707) 578 88 11
(+1 800) 444 53 66
Fax: (+1 707) 578 08 69
info-US@lemo.com

LEMO DISTRIBUTORS

ARGENTINA, AUSTRALIA, BRAZIL, CHILE, COLOMBIA, CZECH REPUBLIC,
GREECE, INDIA, ISRAEL, NEW ZEALAND, PERU, POLAND, RUSSIA,
SOUTH AFRICA, SOUTH KOREA, TAIWAN, TURKEY, UKRAINE

www.lemo.com



55: AW-T662NRT 8-3 SPL +/- IMP 3ohm

Mouser Electronics

Authorized Distributor

Click to View Pricing, Inventory, Delivery & Lifecycle Information:

LEMO:

[RAD.0S.250.CTM](#) [EGG.2B.802.CLL1](#) [EEP.2E.675.CTL](#) [EGG.3B.846.CLL1](#) [EGG.3K.8H4.CLL1](#) [EPA.0S.250.NTN](#)
[EPL.00.650.NLNY](#) [ERA.1S.250.CLL](#) [ERA.2S.250.CTL](#) [ERA.4S.275.CTL](#) [ERN.0S.650.CTL](#) [FAA.1S.275.CLA](#)
[PCA.0S.650.CTLC17Z](#) [PCA.0S.650.CTXC44](#) [FFA.0E.650.CTAC30](#) [FFA.0S.250.CTAC17](#) [FFA.0S.250.CTAC27Z](#)
[FFA.0S.650.CTAC17](#) [FFA.0S.650.CTAC32](#) [FFA.0S.650.CTAC32Z](#) [FFA.1E.250.CLAC50Z](#) [FFA.1E.250.CLAZ](#)
[FFA.1E.250.CTAC50](#) [PSA.0S.250.CTLC17](#) [PSA.1S.650.CTLC62](#) [PSA.2S.250.CTLC52](#) [SWH.0S.650.CTMPV](#)
[EBC.5S.810.CLL2](#) [FGG.3B.846.CLAD101](#) [EPL.00.650.NLN](#) [FGG.3K.8H2.CJCK111](#) [FFS.2B.250.ZLCE30](#)
[ERN.1S.650.CTL](#) [ABA.1S.250.NTL](#) [ABF.0S.250.NTA](#) [ABF.1S.250.NTA](#) [FFA.1S.250.CLAC52](#) [FFA.1S.250.CTAC62](#)
[FFA.2E.675.CTAC75](#) [FFC.00.650.CLAC17](#) [FFC.00.650.GLAC17Z](#) [FGG.3K.8H4.CLAK111](#) [PHG.3K.8H4.CLLK111](#)
[FGL.3K.8H2.CJMK111](#) [FFA.1E.275.CTAC25Z](#) [PHG.1K.308.CLLK85](#) [EEP.2E.650.CTL](#) [FFA.1E.650.CTAC45Z](#)
[FLA.3E.250.CLAC11E](#) [EBG.1R.803.GLM81](#) [HGP.3E.250.CLLPE](#) [EHG.1B.801.CLL2](#) [HGP.3E.275.CLLPE](#)
[FFA.1S.275.NTAC42](#) [DCC.91.019.1AK](#) [PKG.M0.8GL.LA](#) [EGG.2B319.CLL](#)



Компания «ЭлектроПласт» предлагает заключение долгосрочных отношений при поставках импортных электронных компонентов на взаимовыгодных условиях!

Наши преимущества:

- Оперативные поставки широкого спектра электронных компонентов отечественного и импортного производства напрямую от производителей и с крупнейших мировых складов;
- Поставка более 17-ти миллионов наименований электронных компонентов;
- Поставка сложных, дефицитных, либо снятых с производства позиций;
- Оперативные сроки поставки под заказ (от 5 рабочих дней);
- Экспресс доставка в любую точку России;
- Техническая поддержка проекта, помощь в подборе аналогов, поставка прототипов;
- Система менеджмента качества сертифицирована по Международному стандарту ISO 9001;
- Лицензия ФСБ на осуществление работ с использованием сведений, составляющих государственную тайну;
- Поставка специализированных компонентов (Xilinx, Altera, Analog Devices, Intersil, Interpoint, Microsemi, Aeroflex, Peregrine, Syfer, Eurofarad, Texas Instrument, Miteq, Cobham, E2V, MA-COM, Hittite, Mini-Circuits, General Dynamics и др.);

Помимо этого, одним из направлений компании «ЭлектроПласт» является направление «Источники питания». Мы предлагаем Вам помощь Конструкторского отдела:

- Подбор оптимального решения, техническое обоснование при выборе компонента;
- Подбор аналогов;
- Консультации по применению компонента;
- Поставка образцов и прототипов;
- Техническая поддержка проекта;
- Защита от снятия компонента с производства.



Как с нами связаться

Телефон: 8 (812) 309 58 32 (многоканальный)

Факс: 8 (812) 320-02-42

Электронная почта: org@eplast1.ru

Адрес: 198099, г. Санкт-Петербург, ул. Калинина, дом 2, корпус 4, литера А.