

Features

- Low On-Resistance
- Low Gate Threshold Voltage
- Low Input Capacitance
- Fast Switching Speed
- Low Input/Output Leakage
- **ESD Protected**
- **Totally Lead-Free & Fully RoHS Compliant (Notes 1 & 2)**
- **Halogen and Antimony Free. "Green" Device (Note 3)**
- **Qualified to AEC-Q101 Standards for High Reliability**
- **PPAP Capable (Note 4)**

Mechanical Data

- Case: SOT323
- Case Material: Molded Plastic, "Green" Molding Compound. UL Flammability Classification Rating 94V-0
- Moisture Sensitivity: Level 1 per J-STD-020
- Terminal Connections: See Diagram Below
- Terminals: Finish - Matte Tin Annealed over Alloy 42 Leadframe. Solderable per MIL-STD-202, Method 208 **(e3)**
- Weight: 0.006 grams (Approximate)



ESD PROTECTED



Top View

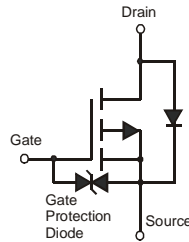

Equivalent Circuit

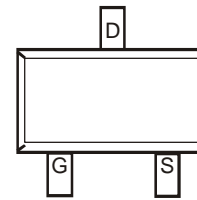

Top View

Ordering Information (Note 5)

| Part Number | Case | Packaging |
|---------------|--------|---------------------|
| DMG1013UWQ-7 | SOT323 | 3000 / Tape & Reel |
| DMG1013UWQ-13 | SOT323 | 10000 / Tape & Reel |

- Notes:
1. No purposely added lead. Fully EU Directive 2002/95/EC (RoHS) & 2011/65/EU (RoHS 2) compliant.
 2. See http://www.diodes.com/quality/lead_free.html for more information about Diodes Incorporated's definitions of Halogen- and Antimony-free, "Green" and Lead-free.
 3. Halogen- and Antimony-free "Green" products are defined as those which contain <900ppm bromine, <900ppm chlorine (<1500ppm total Br + Cl) and <1000ppm antimony compounds.
 4. Automotive products are AEC-Q101 qualified and are PPAP capable. Refer to http://www.diodes.com/product_compliance_definitions.html.
 5. For packaging details, go to our website at <http://www.diodes.com/products/packages.html>.

Marking Information

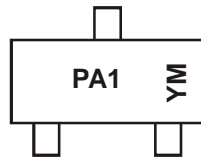

PA1 = Product Type Marking Code
 YM = Date Code Marking
 Y = Year (ex: D = 2016)
 M = Month (ex: 9 = September)

Date Code Key

| Year | 2008 | ... | 2015 | 2016 | 2017 | 2018 | 2019 | 2020 | 2021 | 2022 | 2023 | 2024 |
|------|------|-----|------|------|------|------|------|------|------|------|------|------|
| Code | V | ... | C | D | E | F | G | H | I | J | K | L |

| Month | Jan | Feb | Mar | Apr | May | Jun | Jul | Aug | Sep | Oct | Nov | Dec |
|-------|-----|-----|-----|-----|-----|-----|-----|-----|-----|-----|-----|-----|
| Code | 1 | 2 | 3 | 4 | 5 | 6 | 7 | 8 | 9 | O | N | D |

Maximum Ratings (@T_A = +25°C, unless otherwise specified.)

| Characteristic | | | Symbol | Value | Unit |
|-----------------------------------|--------------|------------------------|------------------|-------|------|
| Drain-Source Voltage | | | V _{DSS} | -20 | V |
| Gate-Source Voltage | | | V _{GSS} | ±6 | V |
| Continuous Drain Current (Note 6) | Steady State | T _A = +25°C | I _D | -0.82 | A |
| | | T _A = +85°C | | -0.54 | |
| Pulsed Drain Current (Note 7) | | | I _{DM} | -3 | A |

Thermal Characteristics

| Characteristic | Symbol | Value | Unit |
|--|-----------------------------------|-------------|------|
| Power Dissipation (Note 6) | P _D | 0.31 | W |
| Thermal Resistance, Junction to Ambient @T _A = +25°C (Note 6) | R _{θJA} | 398 | °C/W |
| Operating and Storage Temperature Range | T _J , T _{STG} | -55 to +150 | °C |

Notes: 6. Device mounted on FR-4 PCB, with minimum recommended pad layout.
7. Repetitive rating, pulse width limited by junction temperature.

Electrical Characteristics (@T_A = +25°C, unless otherwise specified.)

| Characteristic | Symbol | Min | Typ | Max | Unit | Test Condition |
|--|---------------------|------|-------|------|------|--|
| OFF CHARACTERISTICS (Note 8) | | | | | | |
| Drain-Source Breakdown Voltage | BV _{DSS} | -20 | - | - | V | V _{GS} = 0V, I _D = -250μA |
| Zero Gate Voltage Drain Current T _J = +25°C | I _{DSS} | - | - | -100 | nA | V _{DS} = -20V, V _{GS} = 0V |
| Gate-Source Leakage | I _{GSS} | - | - | ±2.0 | μA | V _{GS} = ±4.5V, V _{DS} = 0V |
| ON CHARACTERISTICS (Note 8) | | | | | | |
| Gate Threshold Voltage | V _{GS(TH)} | -0.5 | - | -1.0 | V | V _{DS} = V _{GS} , I _D = -250μA |
| Static Drain-Source On-Resistance | R _{DS(ON)} | - | 0.5 | 0.75 | Ω | V _{GS} = -4.5V, I _D = -430mA |
| | | | 0.7 | 1.05 | | V _{GS} = -2.5V, I _D = -300mA |
| | | | 1.0 | 1.5 | | V _{GS} = -1.8V, I _D = -150mA |
| Forward Transfer Admittance | Y _{fs} | - | 0.9 | - | S | V _{DS} = -10V, I _D = -250mA |
| Diode Forward Voltage | V _{SD} | - | -0.8 | -1.2 | V | V _{GS} = 0V, I _S = -150mA |
| DYNAMIC CHARACTERISTICS (Note 9) | | | | | | |
| Input Capacitance | C _{iss} | - | 59.76 | - | pF | V _{DS} = -16V, V _{GS} = 0V, f = 1.0MHz |
| Output Capacitance | C _{oss} | - | 12.07 | - | pF | |
| Reverse Transfer Capacitance | C _{riss} | - | 6.36 | - | pF | |
| Total Gate Charge | Q _g | - | 622.4 | - | pC | V _{GS} = -4.5V, V _{DS} = -10V, I _D = -250mA |
| Gate-Source Charge | Q _{gs} | - | 100.3 | - | pC | |
| Gate-Drain Charge | Q _{gd} | - | 132.2 | - | pC | |
| Turn-On Delay Time | t _{D(ON)} | - | 5.1 | - | ns | V _{DD} = -10V, V _{GS} = -4.5V, R _L = 47Ω, R _G = 10Ω, I _D = -200mA |
| Turn-On Rise Time | t _R | - | 8.1 | - | ns | |
| Turn-Off Delay Time | t _{D(OFF)} | - | 28.4 | - | ns | |
| Turn-Off Fall Time | t _F | - | 20.7 | - | ns | |

Notes: 8. Short duration pulse test used to minimize self-heating effect.
9. Guaranteed by design. Not subject to production testing.

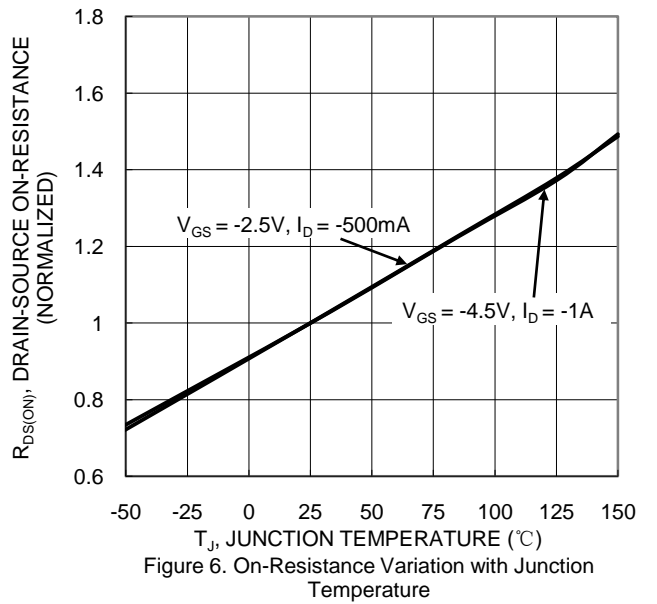
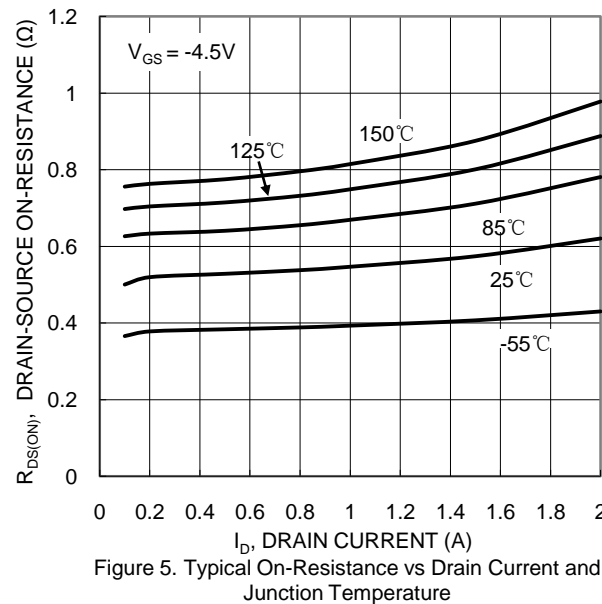
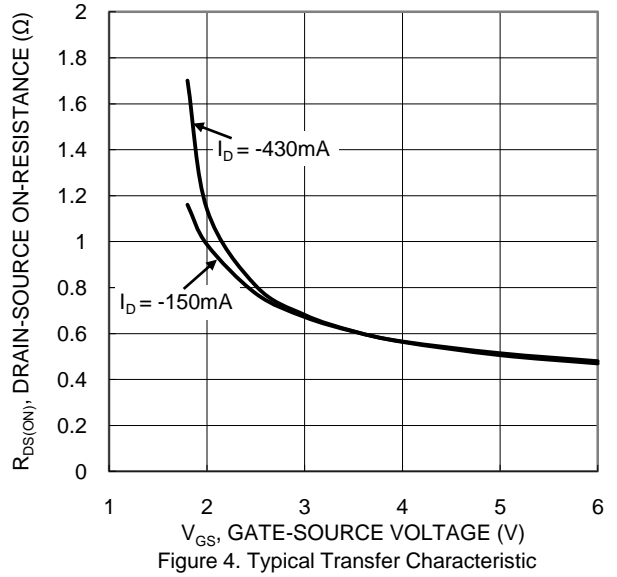
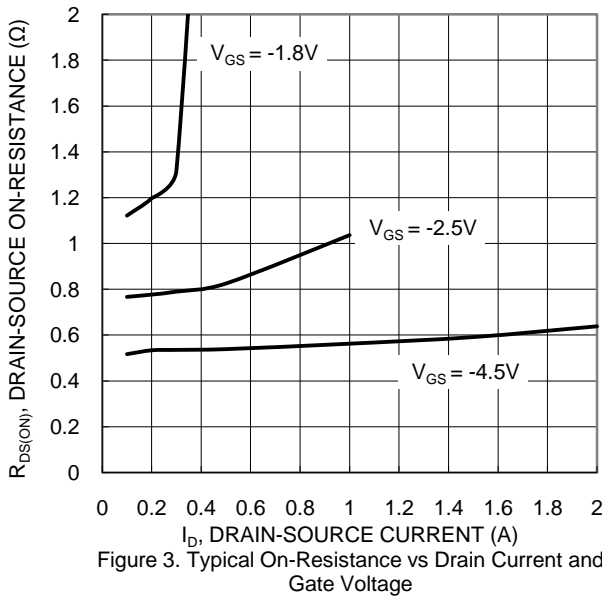
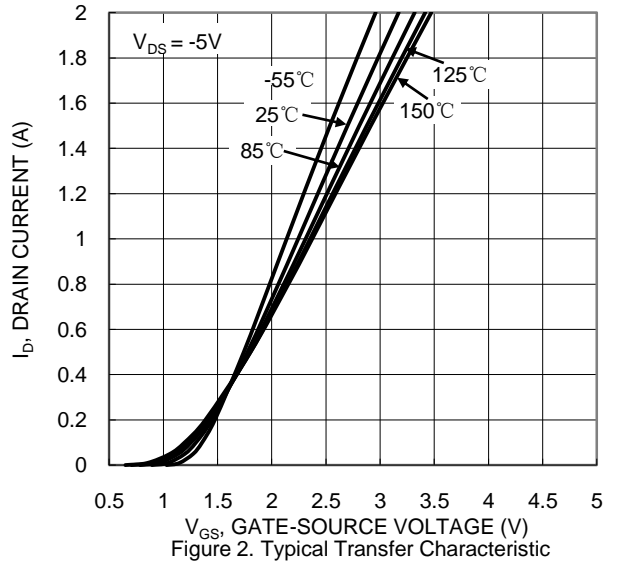
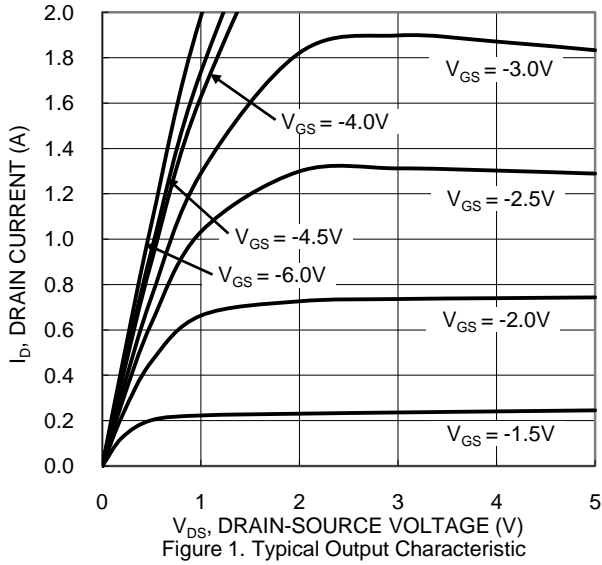

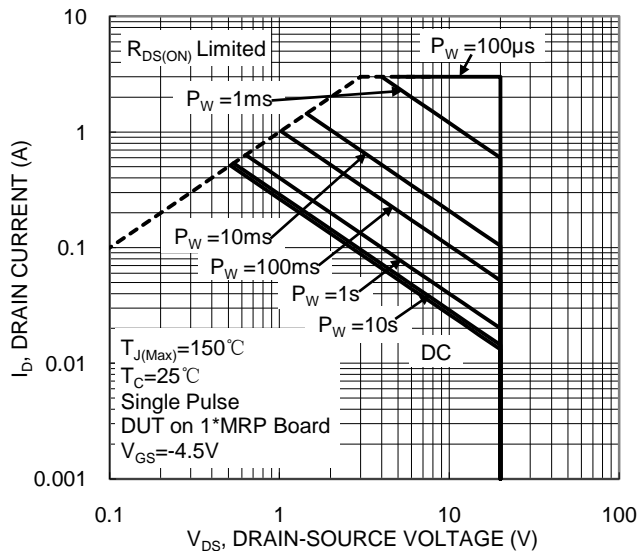
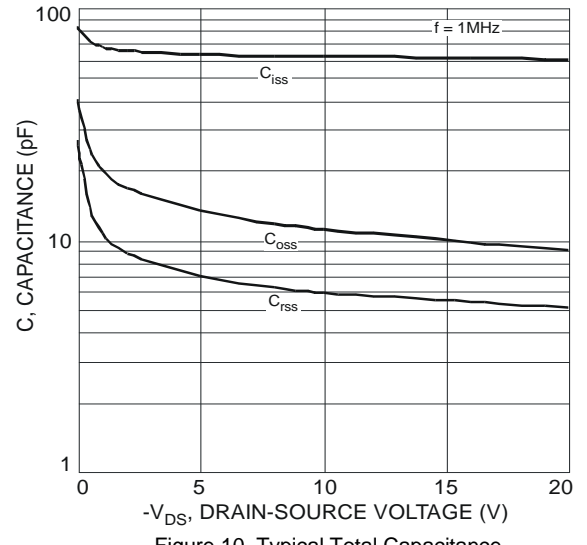
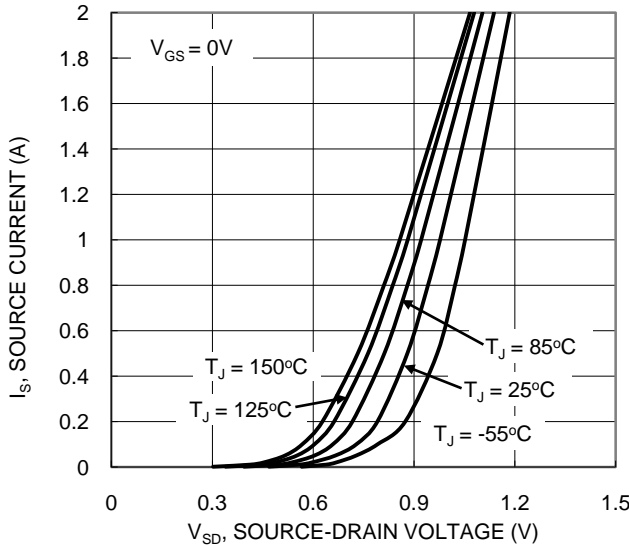
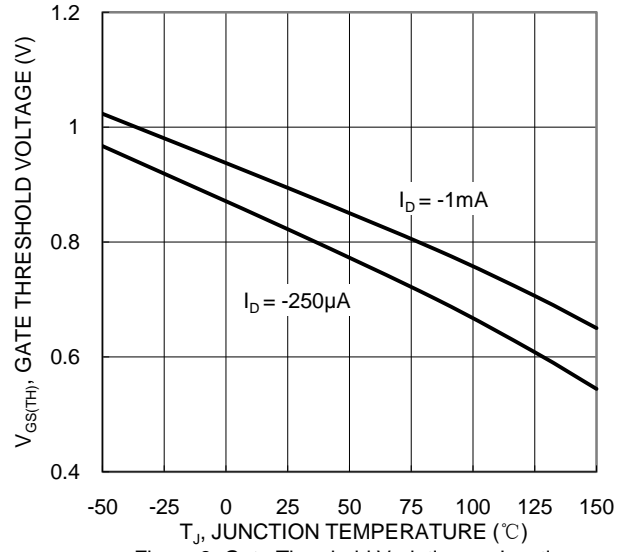
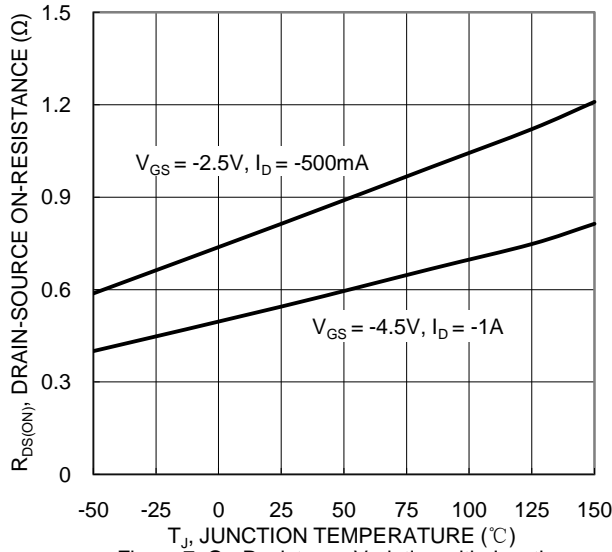

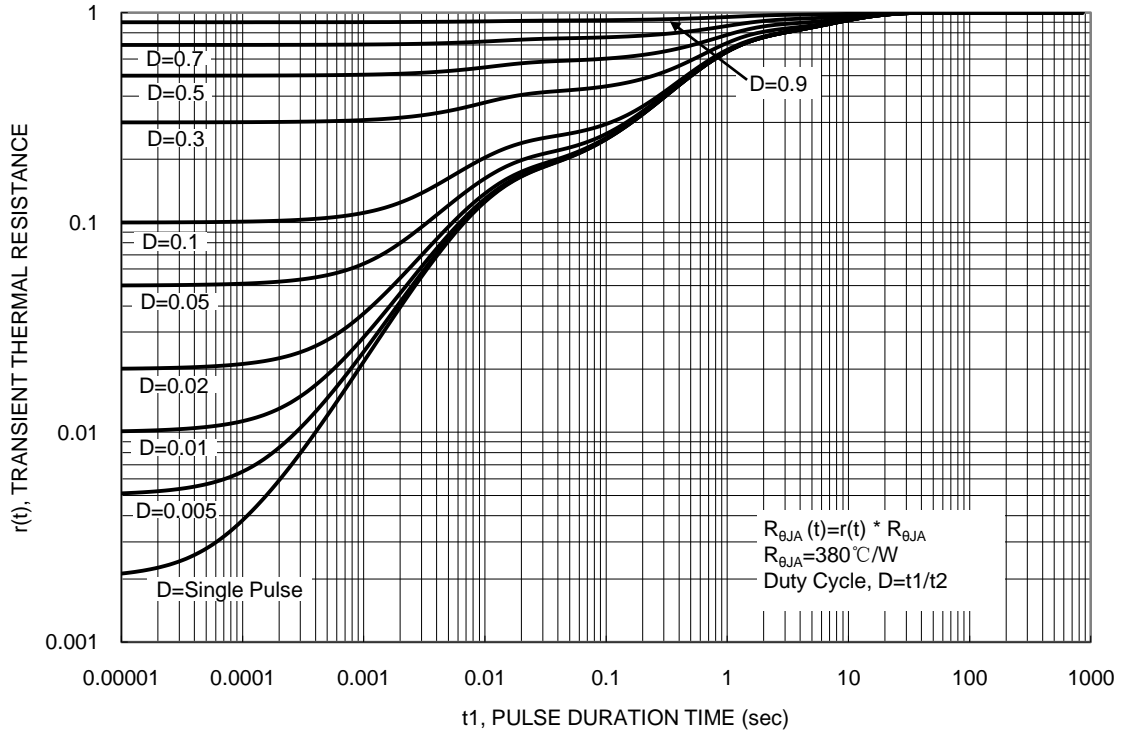
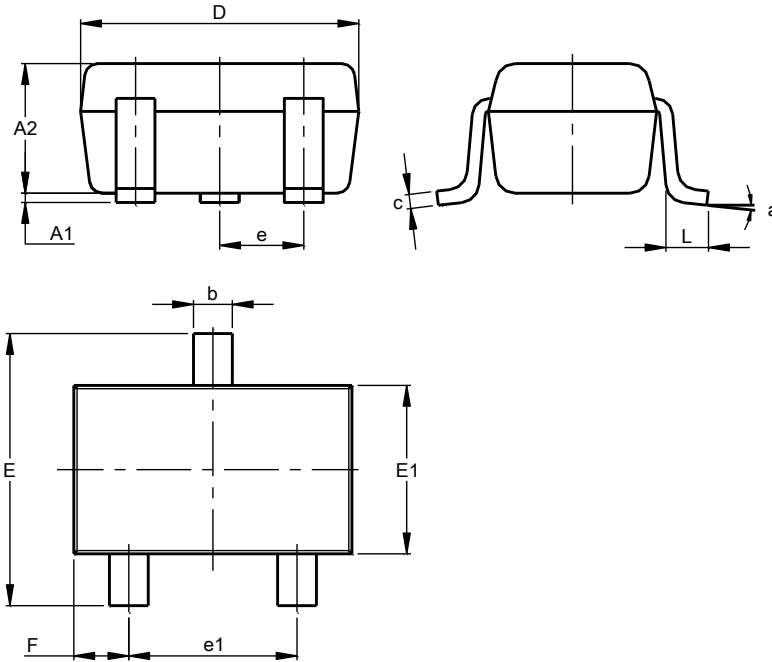

Figure 12. Transient Thermal Resistance

Package Outline Dimensions

Please see AP02001 at http://www.diodes.com/_files/datasheets/ap02001.pdf for the latest version.

SOT323



| SOT323 | | | |
|----------------------|-----------|-------|-------|
| Dim | Min | Max | Typ |
| A1 | 0.00 | 0.10 | 0.05 |
| A2 | 0.90 | 1.00 | 0.95 |
| b | 0.25 | 0.40 | 0.30 |
| c | 0.10 | 0.18 | 0.11 |
| D | 1.80 | 2.20 | 2.15 |
| E | 2.00 | 2.20 | 2.10 |
| E1 | 1.15 | 1.35 | 1.30 |
| e | 0.650 BSC | | |
| e1 | 1.20 | 1.40 | 1.30 |
| F | 0.375 | 0.475 | 0.425 |
| L | 0.25 | 0.40 | 0.30 |
| a | 8° | | |
| All Dimensions in mm | | | |

Suggested Pad Layout

Please see AP02001 at http://www.diodes.com/_files/datasheets/ap02001.pdf for the latest version.

SOT323

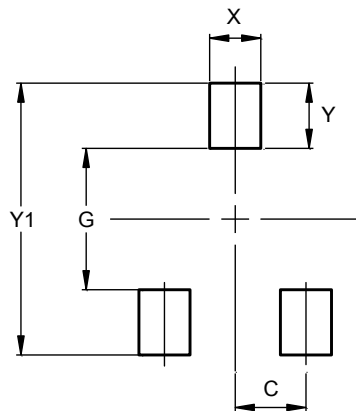

| Dimensions | Value (in mm) |
|------------|---------------|
| C | 0.650 |
| G | 1.300 |
| X | 0.470 |
| Y | 0.600 |
| Y1 | 2.500 |

IMPORTANT NOTICE

DIODES INCORPORATED MAKES NO WARRANTY OF ANY KIND, EXPRESS OR IMPLIED, WITH REGARDS TO THIS DOCUMENT, INCLUDING, BUT NOT LIMITED TO, THE IMPLIED WARRANTIES OF MERCHANTABILITY AND FITNESS FOR A PARTICULAR PURPOSE (AND THEIR EQUIVALENTS UNDER THE LAWS OF ANY JURISDICTION).

Diodes Incorporated and its subsidiaries reserve the right to make modifications, enhancements, improvements, corrections or other changes without further notice to this document and any product described herein. Diodes Incorporated does not assume any liability arising out of the application or use of this document or any product described herein; neither does Diodes Incorporated convey any license under its patent or trademark rights, nor the rights of others. Any Customer or user of this document or products described herein in such applications shall assume all risks of such use and will agree to hold Diodes Incorporated and all the companies whose products are represented on Diodes Incorporated website, harmless against all damages.

Diodes Incorporated does not warrant or accept any liability whatsoever in respect of any products purchased through unauthorized sales channel. Should Customers purchase or use Diodes Incorporated products for any unintended or unauthorized application, Customers shall indemnify and hold Diodes Incorporated and its representatives harmless against all claims, damages, expenses, and attorney fees arising out of, directly or indirectly, any claim of personal injury or death associated with such unintended or unauthorized application.

Products described herein may be covered by one or more United States, international or foreign patents pending. Product names and markings noted herein may also be covered by one or more United States, international or foreign trademarks.

This document is written in English but may be translated into multiple languages for reference. Only the English version of this document is the final and determinative format released by Diodes Incorporated.

LIFE SUPPORT

Diodes Incorporated products are specifically not authorized for use as critical components in life support devices or systems without the express written approval of the Chief Executive Officer of Diodes Incorporated. As used herein:

A. Life support devices or systems are devices or systems which:

1. are intended to implant into the body, or
2. support or sustain life and whose failure to perform when properly used in accordance with instructions for use provided in the labeling can be reasonably expected to result in significant injury to the user.

B. A critical component is any component in a life support device or system whose failure to perform can be reasonably expected to cause the failure of the life support device or to affect its safety or effectiveness.

Customers represent that they have all necessary expertise in the safety and regulatory ramifications of their life support devices or systems, and acknowledge and agree that they are solely responsible for all legal, regulatory and safety-related requirements concerning their products and any use of Diodes Incorporated products in such safety-critical, life support devices or systems, notwithstanding any devices- or systems-related information or support that may be provided by Diodes Incorporated. Further, Customers must fully indemnify Diodes Incorporated and its representatives against any damages arising out of the use of Diodes Incorporated products in such safety-critical, life support devices or systems.

Copyright © 2016, Diodes Incorporated

www.diodes.com



Компания «ЭлектроПласт» предлагает заключение долгосрочных отношений при поставках импортных электронных компонентов на взаимовыгодных условиях!

Наши преимущества:

- Оперативные поставки широкого спектра электронных компонентов отечественного и импортного производства напрямую от производителей и с крупнейших мировых складов;
- Поставка более 17-ти миллионов наименований электронных компонентов;
- Поставка сложных, дефицитных, либо снятых с производства позиций;
- Оперативные сроки поставки под заказ (от 5 рабочих дней);
- Экспресс доставка в любую точку России;
- Техническая поддержка проекта, помощь в подборе аналогов, поставка прототипов;
- Система менеджмента качества сертифицирована по Международному стандарту ISO 9001;
- Лицензия ФСБ на осуществление работ с использованием сведений, составляющих государственную тайну;
- Поставка специализированных компонентов (Xilinx, Altera, Analog Devices, Intersil, Interpoint, Microsemi, Aeroflex, Peregrine, Syfer, Eurofarad, Texas Instrument, Miteq, Cobham, E2V, MA-COM, Hittite, Mini-Circuits, General Dynamics и др.);

Помимо этого, одним из направлений компании «ЭлектроПласт» является направление «Источники питания». Мы предлагаем Вам помощь Конструкторского отдела:

- Подбор оптимального решения, техническое обоснование при выборе компонента;
- Подбор аналогов;
- Консультации по применению компонента;
- Поставка образцов и прототипов;
- Техническая поддержка проекта;
- Защита от снятия компонента с производства.



Как с нами связаться

Телефон: 8 (812) 309 58 32 (многоканальный)

Факс: 8 (812) 320-02-42

Электронная почта: org@eplast1.ru

Адрес: 198099, г. Санкт-Петербург, ул. Калинина, дом 2, корпус 4, литера А.