

FEATURES

- Low offset voltage: 400 μ V maximum**
- High current gain: 300 minimum**
- Excellent current gain match: 4% maximum**
- Low voltage noise density at 100 Hz, 1 mA**
3 nV/ $\sqrt{\text{Hz}}$ maximum
- Excellent log conformance**
Bulk resistance (r_{BE}) = 0.6 Ω maximum
- Guaranteed matching for all transistors**

APPLICATIONS

- Low noise op amp front end**
- Current mirror and current sink/source**
- Low noise instrumentation amplifiers**
- Voltage controlled attenuators**
- Log amplifiers**

GENERAL DESCRIPTION

The MAT14 is a quad monolithic NPN transistor that offers excellent parametric matching for precision amplifier and nonlinear circuit applications. Performance characteristics of the MAT14 include high gain (300 minimum) over a wide range of collector current, low noise (3 nV/ $\sqrt{\text{Hz}}$ maximum at 100 Hz, $I_C = 1$ mA), and excellent logarithmic conformance. The MAT14 also features a low offset voltage of 100 μ V typical and tight current gain matching to within 4%. Each transistor of the MAT14 is individually tested to data sheet specifications. For matching parameters (offset voltage, input offset current, and gain match), each of the dual transistor combinations are

PIN CONFIGURATION

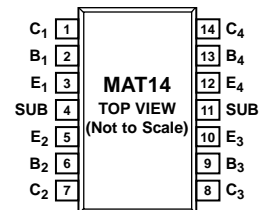

Figure 1.

verified to meet stated limits. Device performance is guaranteed at an ambient temperature of 25°C and over the industrial temperature range.

The long-term stability of matching parameters is guaranteed by the protection diodes across the base emitter junction of each transistor. These diodes prevent degradation of beta and matching characteristics due to reverse bias, base emitter current. The superior logarithmic conformance and accurate matching characteristics of the MAT14 make it an excellent choice for use in log and antilog circuits. The MAT14 is an ideal choice in applications where low noise and high gain are required.

Rev. A

Information furnished by Analog Devices is believed to be accurate and reliable. However, no responsibility is assumed by Analog Devices for its use, nor for any infringements of patents or other rights of third parties that may result from its use. Specifications subject to change without notice. No license is granted by implication or otherwise under any patent or patent rights of Analog Devices. Trademarks and registered trademarks are the property of their respective owners.

TABLE OF CONTENTS

Features	1	Thermal Resistance	4
Applications.....	1	ESD Caution.....	4
Pin Configuration.....	1	Typical Performance Characteristics	5
General Description	1	Theory of Operation	8
Revision History	2	Applications Information	8
Specifications.....	3	Outline Dimensions	9
Electrical Characteristics	3	Ordering Guide	9
Absolute Maximum Ratings.....	4		

REVISION HISTORY

12/10—Rev. 0 to Rev. A

Changes to General Description	1
Changes to Operating Temperature Range in Table 2.....	4
Updated Outline Dimensions	9
Changes to Ordering Guide	9

10/10—Revision 0: Initial Version

SPECIFICATIONS

ELECTRICAL CHARACTERISTICS

T_A = 25°C, unless otherwise specified.

Table 1.

Parameter	Symbol	Test Conditions/Comments	Min	Typ	Max	Unit
DC AND AC CHARACTERISTICS						
Current Gain	h_{FE}	$10 \mu A \leq I_C \leq 1 \text{ mA}$ $0 \text{ V} \leq V_{CB} \leq 30 \text{ V}^1$ $-40^\circ\text{C} \leq T_A \leq +85^\circ\text{C}$	300	600		
Current Gain Match	Δh_{FE}	$I_C = 100 \mu A^2$ $0 \text{ V} \leq V_{CB} \leq 30 \text{ V}$		1	4	%
Noise Voltage Density	e_N	$I_C = 1 \text{ mA}, V_{CB} = 0 \text{ V}^3$ $f_O = 10 \text{ Hz}$ $f_O = 100 \text{ Hz}$ $f_O = 1 \text{ kHz}$		2	4	nV/ $\sqrt{\text{Hz}}$
Offset Voltage	V_{OS}	$10 \mu A \leq I_C \leq 1 \text{ mA}^4$ $0 \text{ V} \leq V_{CB} \leq 30 \text{ V}$ $-40^\circ\text{C} \leq T_A \leq +85^\circ\text{C}$		100	400	μV
Offset Voltage Change vs. V _{CB} Change	$\Delta V_{OS}/\Delta V_{CB}$	$0 \text{ V} \leq V_{CB} \leq 30 \text{ V}^4$ $10 \mu A \leq I_C \leq 1 \text{ mA}$		120	520	μV
Offset Voltage Change vs. I _C Change	$\Delta V_{OS}/\Delta I_C$	$10 \mu A \leq I_C \leq 1 \text{ mA}^4, V_{CB} = 0 \text{ V}$		10	50	μV
Offset Voltage Drift	$\Delta V_{OS}/\Delta T$	$-40^\circ\text{C} \leq T_A \leq +85^\circ\text{C}$ $I_C = 100 \mu A, V_{CB} = 0 \text{ V}$			0.4	$\mu\text{V}/^\circ\text{C}$
Breakdown Voltage	BV_{CEO}	$I_C = 10 \mu A$ $-40^\circ\text{C} \leq T_A \leq +85^\circ\text{C}$	40			V
Gain-Bandwidth Product	f_T	$I_C = 1 \text{ mA}, V_{CE} = 10 \text{ V}$	40	300		MHz
Collector Leakage Current						
Base	I_{CBO}	$V_{CB} = 40 \text{ V}$ $-40^\circ\text{C} \leq T_A \leq +85^\circ\text{C}$		5		pA
Substrate	I_{CS}	$V_{CS} = 40 \text{ V}$ $-40^\circ\text{C} \leq T_A \leq +85^\circ\text{C}$		0.5		nA
Emitter	I_{CES}	$V_{CE} = 40 \text{ V}$ $-40^\circ\text{C} \leq T_A \leq +85^\circ\text{C}$		0.7		nA
Input Current						
Bias	I_B	$I_C = 100 \mu A, 0 \text{ V} \leq V_{CB} \leq 30 \text{ V}$ $-40^\circ\text{C} \leq T_A \leq +85^\circ\text{C}$		165	330	nA
Offset	I_{OS}	$I_C = 100 \mu A, V_{CB} = 0 \text{ V}$ $-40^\circ\text{C} \leq T_A \leq +85^\circ\text{C}$		2	13	nA
Offset Drift	$\Delta I_{OS}/\Delta T$	$I_C = 100 \mu A$ $-40^\circ\text{C} \leq T_A \leq +85^\circ\text{C}$		8	40	nA
Collector Saturation Voltage	$V_{CE(SAT)}$	$I_C = 1 \text{ mA}, I_B = 100 \mu A$		0.03	0.06	V
Output Capacitance	C_{OBO}	$V_{CB} = 15 \text{ V}, I_E^5 = 0, f = 1 \text{ MHz}$		10		pF
Bulk Resistance	r_{BE}	$10 \mu A \leq I_C \leq 10 \text{ mA}, V_{CB} = 0 \text{ V}^6$		0.4	0.6	Ω
Input Capacitance	C_{EBO}	$V_{CB} = 15 \text{ V}, I_E = 0, f = 1 \text{ MHz}$		40		pF

¹ Current gain measured at I_C = 10 μA, 100 μA, and 1 mA.

² Current gain match (Δh_{FE}) defined as: $\Delta h_{FE} = (100(\Delta I_B)/(h_{FE \text{ min}})/I_C)$.

³ Sample tested.

⁴ Measured at I_C = 10 μA and guaranteed by design over the specified range of I_C.

⁵ See Table 2 for the emitter current rating.

⁶ Guaranteed by design.

ABSOLUTE MAXIMUM RATINGS

Table 2.

Parameter	Rating
Voltage	
Collector-to-Base Voltage (BV_{CBO})	40 V
Collector-to-Emitter Voltage (BV_{CEO})	40 V
Collector-to-Collector Voltage (BV_{CC})	40 V
Emitter-to-Emitter Voltage (BV_{EE})	40 V
Current	
Collector Current (I_C)	30 mA
Emitter Current (I_E)	30 mA
Temperature	
Storage Temperature Range	-65°C to +150°C
Operating Temperature Range	-40°C to +85°C
Junction Temperature Range	-65°C to +150°C

Stresses above those listed under Absolute Maximum Ratings may cause permanent damage to the device. This is a stress rating only; functional operation of the device at these or any other conditions above those indicated in the operational section of this specification is not implied. Exposure to absolute maximum rating conditions for extended periods may affect device reliability.

THERMAL RESISTANCE

θ_{JA} is specified for the worst-case conditions, that is, a device soldered in a circuit board for surface-mount packages.

Table 3. Thermal Resistance

Package Type	θ_{JA}	θ_{JC}	Unit
14-Lead SOIC	115	36	°C/W

ESD CAUTION



ESD (electrostatic discharge) sensitive device. Charged devices and circuit boards can discharge without detection. Although this product features patented or proprietary protection circuitry, damage may occur on devices subjected to high energy ESD. Therefore, proper ESD precautions should be taken to avoid performance degradation or loss of functionality.

TYPICAL PERFORMANCE CHARACTERISTICS

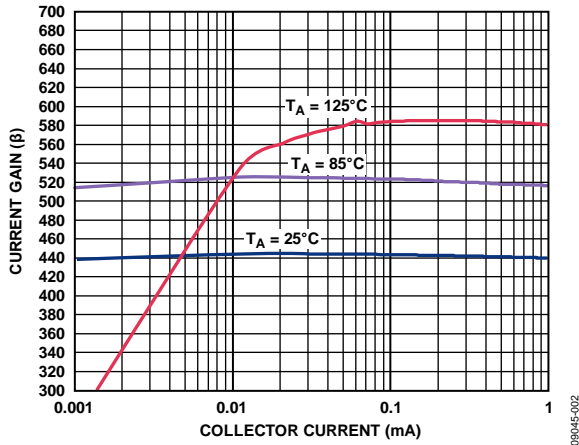

Figure 2. Current Gain vs. Collector Current

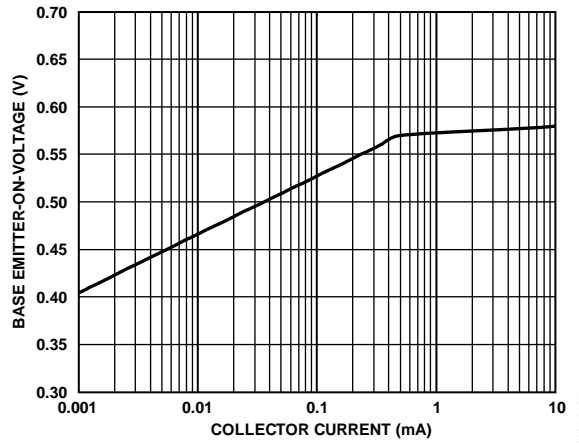

Figure 5. Base Emitter-On-Voltage vs. Collector Current

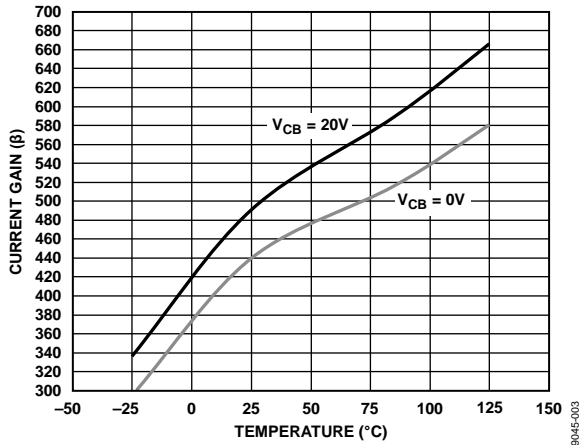

Figure 3. Current Gain vs. Temperature

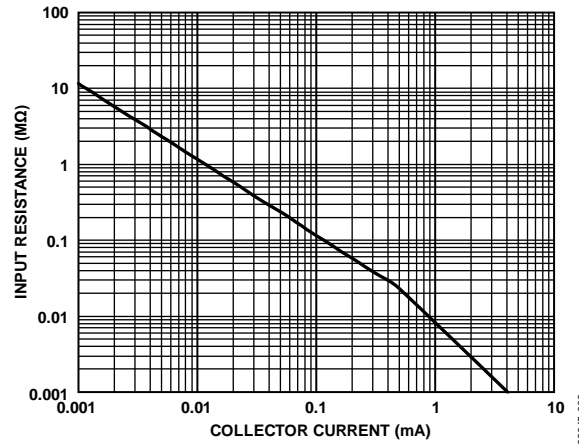

Figure 6. Small Signal Input Resistance vs. Collector Current

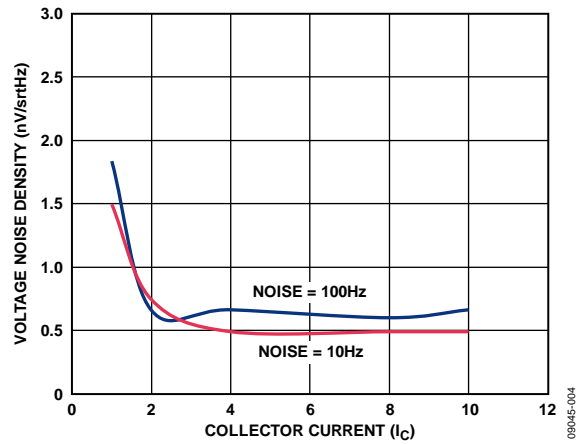

Figure 4. Voltage Noise Density vs. Collector Current

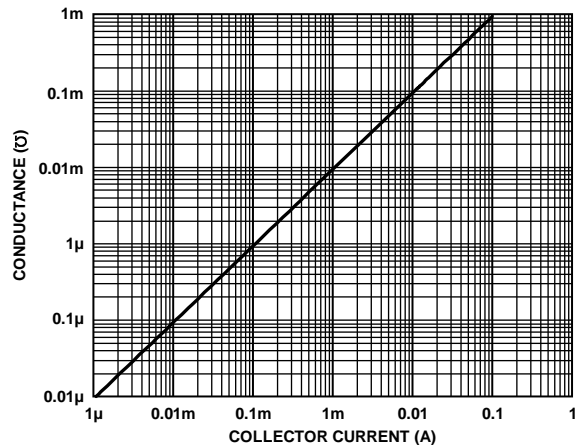

Figure 7. Small Signal Output Conductance vs. Collector Current

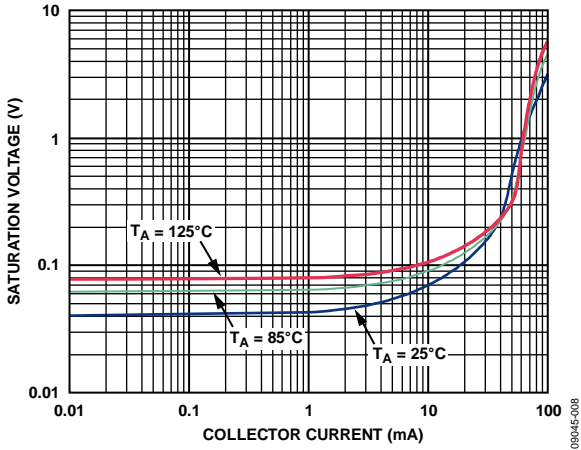

Figure 8. Saturation Voltage vs. Collector Current

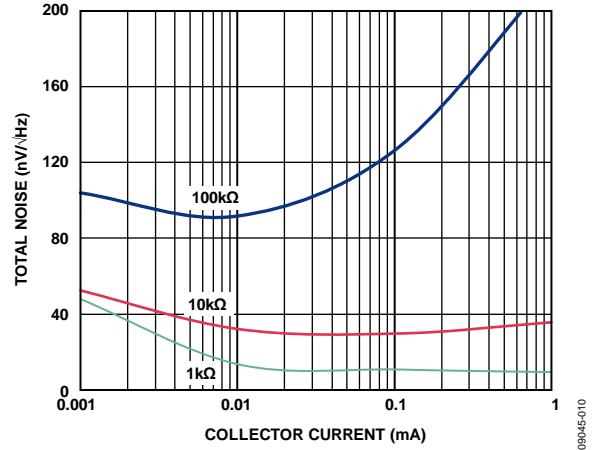

Figure 10. Total Noise vs. Collector Current

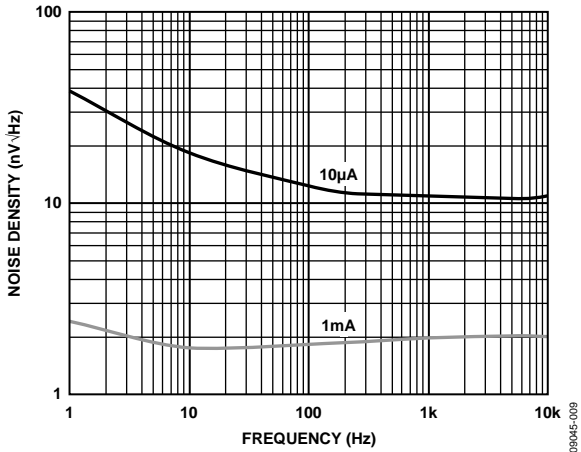

Figure 9. Noise Voltage Density vs. Frequency

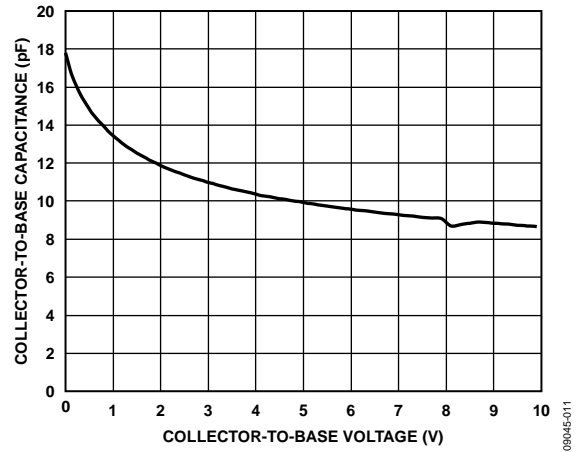

Figure 11. Collector-to-Base Capacitance vs. Collector-to-Base Voltage

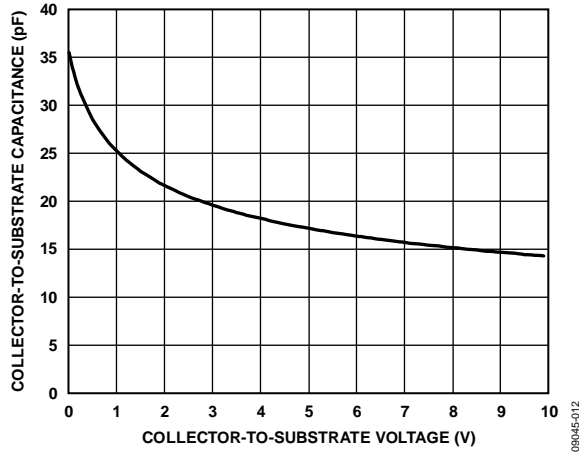

Figure 12. Collector-to-Substrate Capacitance vs. Collector-to-Substrate Voltage

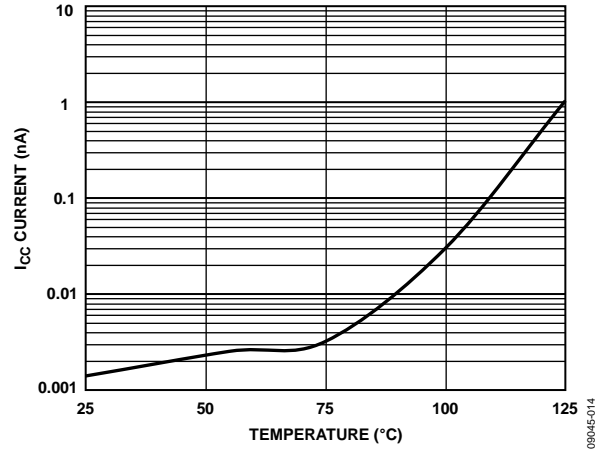

Figure 14. Collector-to-Collector Leakage vs. Temperature

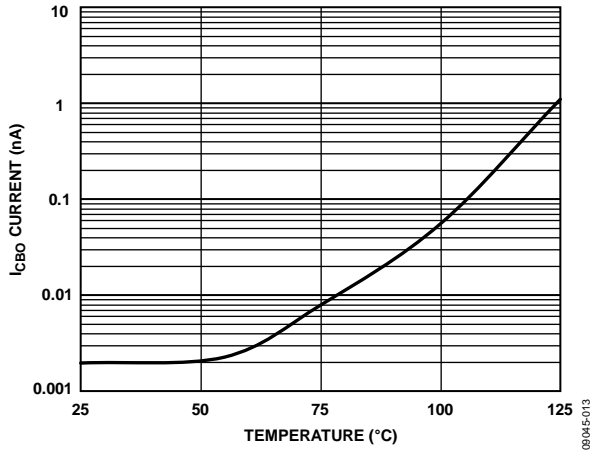

Figure 13. Collector-to-Base Leakage vs. Temperature

THEORY OF OPERATION

APPLICATIONS INFORMATION

To minimize coupling between devices, tie one of the substrate pins (Pin 4 or Pin 11) to the most negative circuit potential. Note that Pin 4 and Pin 11 are internally connected.

Applications Current Sources

MAT14 can be used to implement a variety of high impedance current mirrors as shown in Figure 15, Figure 16, and Figure 17. These current mirrors can be used as biasing elements and load devices for amplifier stages.

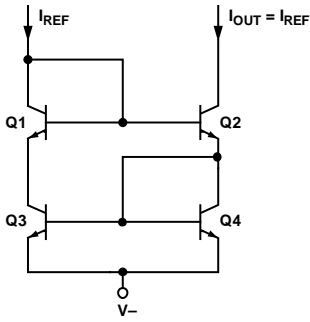

Figure 15. Unity-Gain Current Mirror, $I_{OUT} = I_{REF}$

The unity-gain current mirror shown in Figure 15 has an accuracy of better than 1% and an output impedance of more than 100 MΩ at 100 μA.

Figure 16 and Figure 17 each show a modified current mirror; Figure 16 is designed for a current gain of two (2), and Figure 17 is designed for a current gain of one-half (1/2). The accuracy of

these mirrors is reduced from that of the unity-gain source due to base current errors but remains better than 2%.

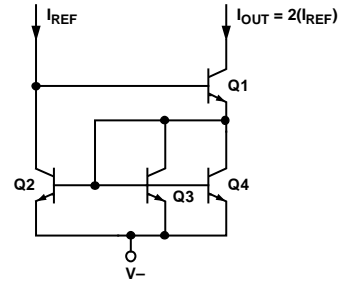

Figure 16. Current Mirror, $I_{OUT} = 2(I_{REF})$

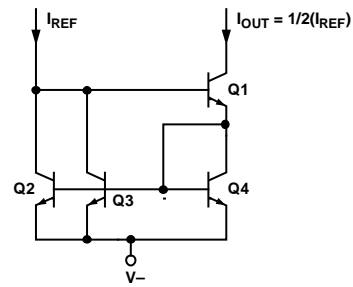

Figure 17. Current Mirror, $I_{OUT} = 1/2(I_{REF})$

Figure 18 is a temperature independent current sink that has an accuracy of better than 1% at an output current of 100 μA to 1 mA. A Schottky diode acts as a clamp to ensure correct circuit startup at power-on. Use 1% metal film type resistors in this circuit.

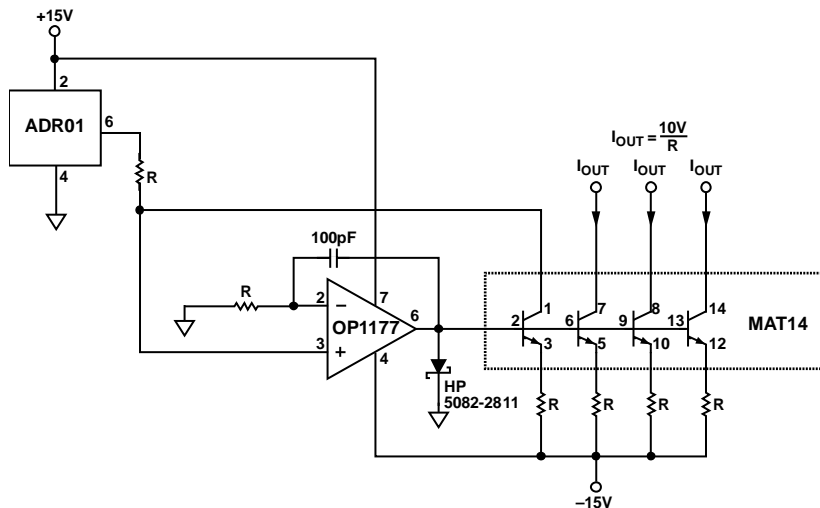
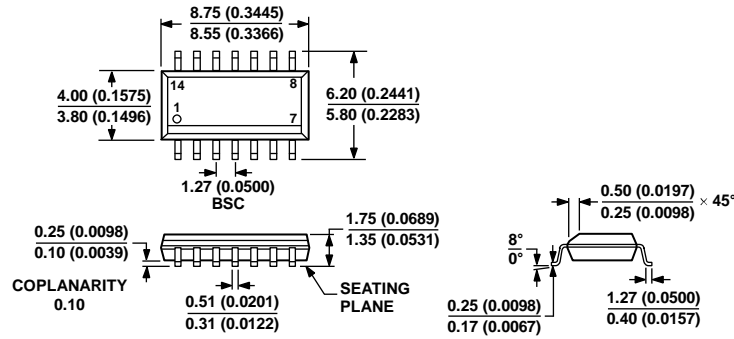

Figure 18. Temperature Independent Current Sink, $I_{OUT} = 10 V/R$

OUTLINE DIMENSIONS



COMPLIANT TO JEDEC STANDARDS MS-012-AB
 CONTROLLING DIMENSIONS ARE IN MILLIMETERS; INCH DIMENSIONS
 (IN PARENTHESES) ARE ROUNDED-OFF MILLIMETER EQUIVALENTS FOR
 REFERENCE ONLY AND ARE NOT APPROPRIATE FOR USE IN DESIGN.

Figure 19. 14-Lead Standard Small Outline Package [SOIC_N]
 Narrow Body
 (R-14)

Dimensions shown in millimeters and (inches)

060806-A

ORDERING GUIDE

Model ¹	Temperature Range	Package Description	Package Option
MAT14ARZ	-40°C to +85°C	14-Lead Standard Small Outline Package [SOIC_N]	R-14
MAT14ARZ-R7	-40°C to +85°C	14-Lead Standard Small Outline Package [SOIC_N]	R-14
MAT14ARZ-RL	-40°C to +85°C	14-Lead Standard Small Outline Package [SOIC_N]	R-14

¹ Z = RoHS Compliant Part.

MAT14

NOTES

NOTES

MAT14

NOTES



Компания «ЭлектроПласт» предлагает заключение долгосрочных отношений при поставках импортных электронных компонентов на взаимовыгодных условиях!

Наши преимущества:

- Оперативные поставки широкого спектра электронных компонентов отечественного и импортного производства напрямую от производителей и с крупнейших мировых складов;
- Поставка более 17-ти миллионов наименований электронных компонентов;
- Поставка сложных, дефицитных, либо снятых с производства позиций;
- Оперативные сроки поставки под заказ (от 5 рабочих дней);
- Экспресс доставка в любую точку России;
- Техническая поддержка проекта, помощь в подборе аналогов, поставка прототипов;
- Система менеджмента качества сертифицирована по Международному стандарту ISO 9001;
- Лицензия ФСБ на осуществление работ с использованием сведений, составляющих государственную тайну;
- Поставка специализированных компонентов (Xilinx, Altera, Analog Devices, Intersil, Interpoint, Microsemi, Aeroflex, Peregrine, Syfer, Eurofarad, Texas Instrument, Miteq, Cobham, E2V, MA-COM, Hittite, Mini-Circuits, General Dynamics и др.);

Помимо этого, одним из направлений компании «ЭлектроПласт» является направление «Источники питания». Мы предлагаем Вам помощь Конструкторского отдела:

- Подбор оптимального решения, техническое обоснование при выборе компонента;
- Подбор аналогов;
- Консультации по применению компонента;
- Поставка образцов и прототипов;
- Техническая поддержка проекта;
- Защита от снятия компонента с производства.



Как с нами связаться

Телефон: 8 (812) 309 58 32 (многоканальный)

Факс: 8 (812) 320-02-42

Электронная почта: org@eplast1.ru

Адрес: 198099, г. Санкт-Петербург, ул. Калинина, дом 2, корпус 4, литера А.