

# EMC/EMI Filter for Installations with Residual Current Device (RCD)



- Full functionality with RCDs according to IEC 61008 and new VDE 0664-110\*
- Compatible with 30 mA RCDs up to 30 m motor cable for electric shock protection according to IEC 61008
- Compatible with 300 mA RCDs up to 100 m motor cable for fire protection according to IEC 60364-4-42 (VDE 0100-482)



### Performance indicators

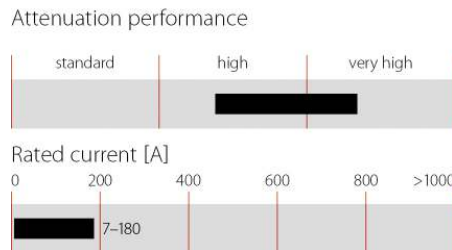

### Technical specifications

<b>Design corresponding to</b>	UL 1283, CSA 22.2 No. 8 1986, IEC/EN 60939
<b>Flammability corresponding to</b>	UL 94 V-2 or better
<b>High potential test voltage</b>	P → E 2650 VDC for 2 sec P → P 2100 VDC for 2 sec
<b>Maximum continuous operating voltage</b>	3x 520/300 VAC
<b>MTBF @ 50°C/400V (Mil-HB-217F)</b>	>300,000 hours
<b>Operating frequency</b>	dc to 60 Hz
<b>Overload capability</b>	4x rated current at switch on, 1.5x rated current for 1 minute, once per hour
<b>Protection category</b>	IP20
<b>Rated currents</b>	7 to 180 A @ 50 °C
<b>Temperature range (operation and storage)</b>	-25 °C to +100 °C (25/100/21)

\* If supply voltage is contaminated with harmonics according to IEC 61000-2-4, class 2, where odd-numbered multiples of three are limited to 30%.  
\*\* Filter types 7 A up to 42 A: C1, 30 m, 30 mA; 55 A: C2, 30 m, 30 mA; 75 A up to 180 A: C2, 100m, 300 mA

### Approvals



### Features and benefits

- Innovative low-leakage current filter with same smallest dimensions as FN 3258
- Significant reduction of leakage and ground currents caused by long motor cables
- Prevents unwanted fault shut-downs from RCDs in machines and process automation equipment
- Patented filter design avoiding early saturation and ringing effects
- Excellent attenuation compliant with: C1 limits EN 61800-3 with 30 meter motor cable and 30 mA RCD (electric shock protection)\*\*
- C2 limits EN 61800-3 with 100 meter motor cable and 300 mA RCD (fire protection)

### Typical applications

- Three-phase variable speed drives (VSD), servo drives, and inverters
- Machinery and process automation equipment
- Building automation, HVAC equipment, pumps, ventilation, and elevators
- Conveyors, handling and storage systems, and cranes
- Machine tools, wood working machines, and printing machines

### Typical electrical schematic

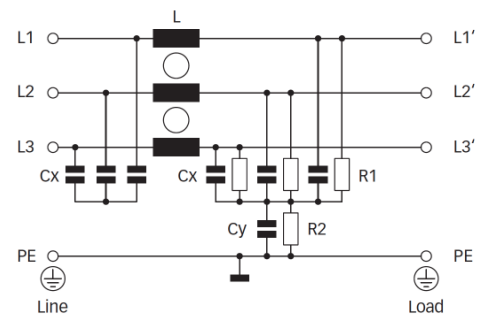

### Filter selection table

Filter	Rated current @ 50 °C (40 °C)	Typical drive power rating*	Leakage current** @ 400 VAC/50 Hz	Power loss @ 25 °C/50 Hz	Input/Output connections	Weight
	[A]	[kW]	[mA]	[W]		[kg]
<b>FN 3268-7-44</b>	7 (7.7)	4	4.5	4.5	-44	0.5
<b>FN 3268-16-44</b>	16 (17.5)	7.5	4.7	6.1	-44	0.8
<b>FN 3268-30-33</b>	30 (32.9)	18.5	4.6	13.5	-33	1.2
<b>FN 3268-42-33</b>	42 (46.0)	22	4.6	17.4	-33	1.4
<b>FN 3268-55-34</b>	55 (60.2)	37	4.7	18.1	-34	2.2
<b>FN 3268-75-34</b>	75 (82.2)	45	7.8	25.3	-34	2.9
<b>FN 3268-100-35</b>	100 (109.5)	55	20.5	30.0	-35	4.1
<b>FN 3268-130-35</b>	130 (142.4)	75	30.4	38.0	-35	4.6
<b>FN 3268-180-40</b>	180 (197.1)	110	37.0	48.6	-40	6.0

\* Calculated at rated current, 440 VAC and cos phi = 0.8. The exact value depends upon the efficiency of the drive, the motor and the entire application.

\*\* Maximum leakage under normal operating conditions. Note: if two phases are interrupted, worst case leakage could reach 5.4 times higher levels.

### Typical filter attenuation

Per CISPR 17; A = 50 Ω/50 Ω sym; B = 50 Ω/50 Ω asym; C = 0.1 Ω/100 Ω sym; D = 100 Ω/0.1 Ω sym

7 to 42 A types

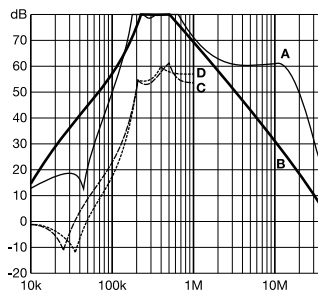

55 to 100 A types

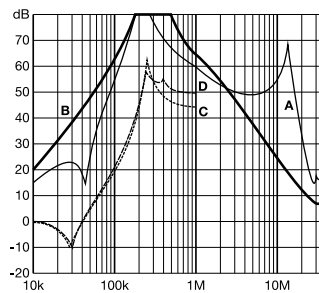

130 and 180 A types

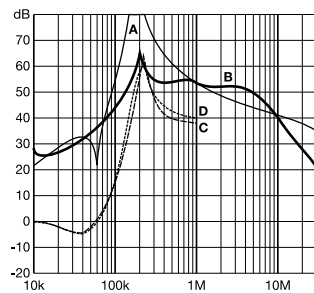

### Installation

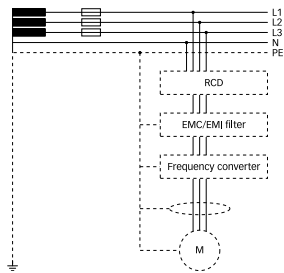

Typical installation with RCD, EMC/EMI filter and motor drive system

**RCD**  
Please note that for electrical devices with 6-pulse rectifiers at line input, like three-phase motor drives, a RCD type B or B+ is required. RCD with time delay are needed to prevent unwanted fault trip at switch on or voltage spikes. These RCD types B with time delay have often an added letter "S" or "K", please ask the supplier for correct type. Caution: Please validate system with chosen RCD to guarantee functionality.

**EMC/EMI filter FN 3268**  
Filter types from 7 to 55 A are designed to be compatible with 30 mA RCDs according to IEC 61008 and new VDE 0664-110 standards. Filters from 75 up to 180 A are designed to be compatible with 300 mA RCDs. Install the filter as close as possible at line side of the motor drive. Regarding correct EMC installation, please refer to the EMC installation guide in the manual from motor drive supplier.

**Motor drive**  
Please set the PWM pulse pattern of the variable speed motor drive fixed to 4 kHz. Other pulse patterns cause higher leakage currents. Filter designs with other pulse pattern than 4 kHz are possible upon request.

**Motor cable length**  
Motor cable length should not exceed 30 meters for 7 up to 55 A filter types to fulfill class C1 of recommended standard EN 61800-3. For 75 up to 180 A filters, cable length should not exceed 100 meters to fulfill class C2.

**Internal EMC/EMI components**  
Please disconnect all internal Y-capacitors (internal EMC/EMI filters) in the motor drive, because these capacitors cause additional leakage currents.

**Harmonics on line voltage**  
High voltage harmonics can create additional system leakage currents. FN 3268 filters are tested under following conditions: Supply voltage is contaminated with harmonics according to IEC 61000-2-4, class 2, where odd-numbered multiples of three are limited to 30%.

## Mechanical data

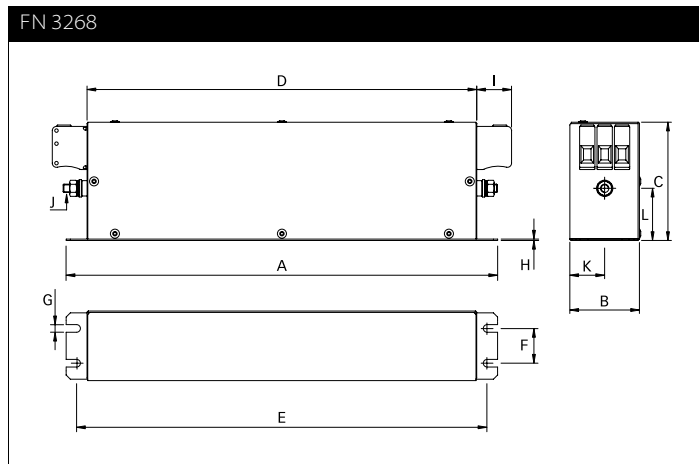

Note: in favour of a better readability, connectors and earth studs are not shown in the horizontal projection.

## Dimensions

	7 A	16 A	30 A	42 A	55 A	75 A	100 A	130 A	180 A
<b>A</b>	190	250	270	310	250	270	270	270	380
<b>B</b>	40	45	50	50	85	80	90	90	120
<b>C</b>	70	70	85	85	90	135	150	150	170
<b>D</b>	160	220	240	280	220	240	240	240	350
<b>E</b>	180	235	255	295	235	255	255	255	365
<b>F</b>	20	25	30	30	60	60	65	65	102
<b>G</b>	4.5	5.4	5.4	5.4	5.4	6.5	6.5	6.5	6.5
<b>H</b>	1	1	1	1	1	1.5	1.5	1.5	1.5
<b>I</b>	22	22	25	25	39	39	45	45	51
<b>J</b>	M5	M5	M5	M6	M6	M6	M10	M10	M10
<b>K</b>	20	22.5	25	25	42.5	40	45	45	60
<b>L</b>	29.5	29.5	39.5	37.5	26.5	70.5	64	64	47

All dimensions in mm; 1 inch = 25.4 mm  
Tolerances according: ISO 2768-m / EN 22768-m

## Filter input/output connector cross sections

	-33	-34	-35	-40	-44
<b>Solid wire</b>	16 mm <sup>2</sup>	35 mm <sup>2</sup>	50 mm <sup>2</sup>	95 mm <sup>2</sup>	10 mm <sup>2</sup>
<b>Flex wire</b>	10 mm <sup>2</sup>	25 mm <sup>2</sup>	50 mm <sup>2</sup>	95 mm <sup>2</sup>	6 mm <sup>2</sup>
<b>AWG type wire</b>	AWG 6	AWG 2	AWG 1/0	AWG 4/0	AWG 8
<b>Recommended torque</b>	1.5-1.8 Nm	4.0-4.5 Nm	7-8 Nm	17-20 Nm	1.5-1.8 Nm

Please visit [www.schaffner.com](http://www.schaffner.com) to find more details on filter connectors.



Компания «ЭлектроПласт» предлагает заключение долгосрочных отношений при поставках импортных электронных компонентов на взаимовыгодных условиях!

Наши преимущества:

- Оперативные поставки широкого спектра электронных компонентов отечественного и импортного производства напрямую от производителей и с крупнейших мировых складов;
- Поставка более 17-ти миллионов наименований электронных компонентов;
- Поставка сложных, дефицитных, либо снятых с производства позиций;
- Оперативные сроки поставки под заказ (от 5 рабочих дней);
- Экспресс доставка в любую точку России;
- Техническая поддержка проекта, помощь в подборе аналогов, поставка прототипов;
- Система менеджмента качества сертифицирована по Международному стандарту ISO 9001;
- Лицензия ФСБ на осуществление работ с использованием сведений, составляющих государственную тайну;
- Поставка специализированных компонентов (Xilinx, Altera, Analog Devices, Intersil, Interpoint, Microsemi, Aeroflex, Peregrine, Syfer, Eurofarad, Texas Instrument, Miteq, Cobham, E2V, MA-COM, Hittite, Mini-Circuits, General Dynamics и др.);

Помимо этого, одним из направлений компании «ЭлектроПласт» является направление «Источники питания». Мы предлагаем Вам помощь Конструкторского отдела:

- Подбор оптимального решения, техническое обоснование при выборе компонента;
- Подбор аналогов;
- Консультации по применению компонента;
- Поставка образцов и прототипов;
- Техническая поддержка проекта;
- Защита от снятия компонента с производства.



#### Как с нами связаться

**Телефон:** 8 (812) 309 58 32 (многоканальный)

**Факс:** 8 (812) 320-02-42

**Электронная почта:** [org@eplast1.ru](mailto:org@eplast1.ru)

**Адрес:** 198099, г. Санкт-Петербург, ул. Калинина, дом 2, корпус 4, литера А.