

G6E

Low Signal Relay

Subminiature, Sensitive SPDT Signal Switching Relay

- High sensitivity: 98-mW (Rated power consumption: 200mW) pickup coil power.
- Impulse withstand voltage of 1,500V (10×160 μs) meets FCC requirements.
- Stick packing employed in consideration of supporting automatic implementation.
- Plastic-sealed model that allows automatic soldering.
- New series of ultrasonically cleanable models is available.
- Standard model conforms to UL/CSA standards.

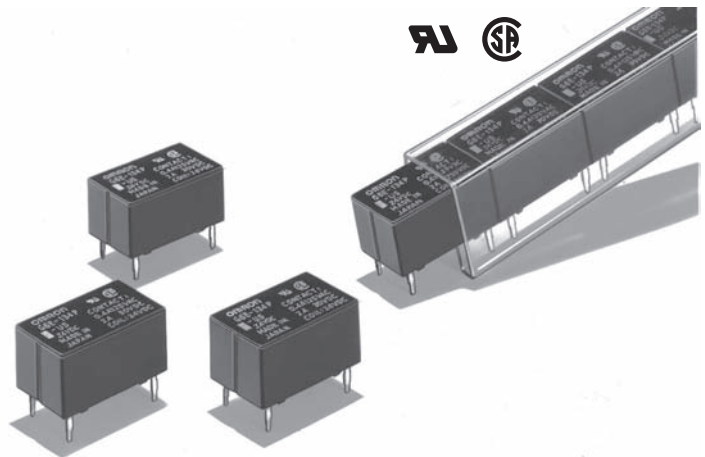

RoHS Compliant

Model Number Legend

G6E-□-□□□□□-□-□
 1 2 3 4 5 6 7 8

1. Relay Function

- None: Single-side stable
 U : Single-winding latching
 K : Double-winding latching

2. Number of poles/ Contact Form

- 1: 1-pole/SPDT (1c)

3. Contact Type

- 3: Bifurcated crossbar Ag
 (Au-Alloy) contact

4. Enclosure Rating

- 4: Fully sealed

5. Terminals Shape

- P: PCB terminals

6. Classification

- None : Standard
 L : Low sensitivity coil
 (400 mW)

7. Approved Standards

- US: UL, CSA
 (UL: FILE No.E41515
 (CSA: FILE No.LR31928)

8. Special Function

- None : Standard
 U : For ultrasonically
 cleanable

Application Examples

- Telecommunication equipment
- Office automation machines
- Industrial equipment
- Security equipment

G
6
E

Ordering Information

Standard Models (UL, CSA certified)

Relay Function	Single-side stable				Single-winding latching		Double-winding latching				Minimum packing unit
	Standard		Low-sensitivity		Standard		Standard		Low-sensitivity		
Classification	Model	Rated coil voltage	Model	Rated coil voltage	Model	Rated coil voltage	Model	Rated coil voltage	Model	Rated coil voltage	
SPDT (1c)	G6E-134P-US	5 VDC	G6E-134PL-US	5 VDC	G6EU-134P-US	5 VDC	G6EK-134P-US	5 VDC	G6EK-134PL-US	5 VDC	25 pcs/tube
		6 VDC		6 VDC		6 VDC		6 VDC			
		9 VDC		9 VDC		9 VDC		9 VDC			
		12 VDC		12 VDC		12 VDC		12 VDC			
		24 VDC		24 VDC		24 VDC		24 VDC			
		48 VDC	-	-	-	-	-	-	-	-	

Models for Ultrasonically Cleanable

Relay Function	Single-side stable				Single-winding latching		Double-winding latching		Minimum packing unit
	Standard		Low-sensitivity		Standard		Standard		
Classification	Model	Rated coil voltage	Model	Rated coil voltage	Model	Rated coil voltage	Model	Rated coil voltage	
SPDT (1c)	G6E-134P-US-U	5 VDC	G6E-134PL-US-U	5 VDC	G6EU-134P-US-U	5 VDC	G6EK-134P-US-U	5 VDC	25 pcs/tube
		6 VDC		-		-		-	
		9 VDC		-		-		-	
		12 VDC		12 VDC		12 VDC		12 VDC	
		24 VDC		24 VDC		-		24 VDC	
		48 VDC	-	-	-	-	-	-	

Note: When ordering, add the rated coil voltage to the model number.

Example: G6E-134P-US DC5

Rated coil voltage

However, the notation of the coil voltage on the product case as well as on the packing will be marked as □□ VDC.

■ Ratings

● Coil: Single-side Stable

Classification	Rated voltage	Rated current (mA)	Coil resistance (Ω)	Must operate voltage (V)	Must release voltage (V)	Max. voltage (V)	Power consumption (mW)
				% of rated voltage			
Standard	5 VDC	40.0	125	70% max.	10% min.	190% (at 23°C)	Approx. 200
	6 VDC	33.3	180				
	9 VDC	22.2	405				
	12 VDC	16.7	720				
	24 VDC	8.3	2,880			170% (at 23°C)	
Low-sensitivity	48 VDC	8.3	5,760	70% max.	10% min.	170% (at 23°C)	Approx. 400
	5 VDC	79.4	63				
	6 VDC	66.6	90				
	9 VDC	44.3	203				
	12 VDC	33.3	360				
	24 VDC	16.7	1,440				

● Coil: Single-winding latching

Contact type	Rated voltage	Rated current (mA)	Coil resistance (Ω)	Must set voltage (V)	Must reset voltage (V)	Max. voltage (V)	Power consumption	
				% of rated voltage			Set coil (mW)	Reset coil (mW)
Bifurcated crossbar	5 VDC	40.0	125	70% max.	70% max.	190% (at 23°C)	Approx. 200	Approx. 200
	6 VDC	33.3	180					
	9 VDC	22.2	405					
	12 VDC	16.7	720					
	24 VDC	8.3	2,880					

● Coil: Double-winding latching

Classification	Rated voltage	Rated current (mA)		Coil resistance (Ω)		Must set voltage (V)	Must reset voltage (V)	Max. voltage (V)	Power consumption	
		Set coil	Reset coil	Set coil	Reset coil				Set coil (mW)	Reset coil (mW)
Standard	5 VDC	40.0	40.0	125	125	70% max.	70% max.	190% (at 23°C)	Approx. 200	Approx. 200
	6 VDC	33.3	33.3	180	180					
	9 VDC	22.2	22.2	405	405					
	12 VDC	16.7	16.7	720	720					
	24 VDC	8.3	8.3	2,880	2,880					
Low-sensitivity	5 VDC	79.4	79.4	63	63	70% max.	70% max.	170% (at 23°C)	Approx. 400	Approx. 400
	6 VDC	66.6	66.6	90	90					
	9 VDC	44.3	44.3	203	203					
	12 VDC	33.3	33.3	360	360					
	24 VDC	16.7	16.7	1,440	1,440					

- Note 1. The rated current and coil resistance are measured at a coil temperature of 23°C with a tolerance of ±10%.
 2. Operating characteristics are measured at a coil temperature of 23°C.
 3. The maximum voltage is the highest voltage that can be imposed on the relay coil.
 4. Refer to the engineering data for relations between the ambient temperature and maximum coil voltage.

● Contacts

Item	Load	
	Resistive load	Inductive load (cosφ = 0.4; L/R = 7 ms)
Contact type	Bifurcated crossbar	
Contact material	Ag (Au-Alloy)	
Rated load	0.4 A at 125 VAC; 2 A at 30 VDC	0.2 A at 125 VAC; 1 A at 30 VDC
Rated carry current	3 A	
Max. switching voltage	250 VAC, 220 VDC	
Max. switching current	3 A	

■ Characteristics (Including Models for Ultrasonically Cleanable)

Item	Relay Function	Single-side Stable	Single-winding Latching	Double-winding Latching
Contact resistance *1			50 mΩ max.	
Operate (set) time			5 ms max.	
Release (reset) time			5 ms max.	
Min. set pulse width				15 ms
Min. reset pulse width				15 ms
Insulation resistance *2			1,000 MΩ min. (at 500 VDC)	
Impulse withstand voltage	Between coil and contacts	2,500 V (10×160 μs) (conforms to FCC part 68)		
	Between contacts of same polarity	1,500 V (10×160 μs) (conforms to FCC part 68)		
Dielectric strength	Between coil and contacts	1,500 VAC, 50/60 Hz for 1 min		
	Between contacts of same polarity	1,000 VAC, 50/60 Hz for 1 min		
Vibration resistance	Destruction	10 to 55 to 10 Hz, 2.5 mm single amplitude (5 mm double amplitude)		
	Malfunction	10 to 55 to 10 Hz, 1.65 mm single amplitude (3.3 mm double amplitude)		
Shock resistance	Destruction	1,000 m/s ²		
	Malfunction	300 m/s ²		
Durability	Mechanical	100,000,000 operations min. (at 36,000 operations/hr)		
	Electrical	100,000 operations min. (0.4 A at 125 VAC resistive load; 0.2 A at 125 VAC inductive load) (at 1,800 operations/hr)		
		500,000 operations min. (2 A at 30 VDC resistive load; 1 A at 30 VDC inductive load) (at 1,800 operations/hr)		
		200,000 operations min. (3 A at 30 VDC resistive load) (at 1,800 operations/hr)		
Failure rate (P level) (reference value) *3		10 μA at 10 mVDC		
Ambient operating temperature		-40°C to 70°C (with no icing or condensation)		
Ambient operating humidity		5% to 85%		
Weight		Approx. 2.7 g		

Note: The values here are initial values.

*1. The contact resistance was measured with 1 A at 5 VDC using a voltage-drop method.

*2. The insulation resistance was measured with a 500 VDC Megger Tester applied to the same parts as those used for checking the dielectric strength.

*3. This value was measured at a switching frequency of 120 operations/min and the criterion of contact resistance is 50 Ω.

This value may vary depending on the switching frequency and operating environment. Always double-check relay suitability under actual operating conditions.

■ Engineering Data

● Maximum Switching Power



● Durability



● Ambient Temperature vs. Maximum Coil Voltage



Note: The maximum coil voltage refers to the maximum value in a varying range of operating power voltage, not a continuous voltage.

● Ambient Temperature vs. Must Operate or Must Release Voltage



● Shock Malfunction G6E-134P-US



G6EK-134P-US



Test Conditions: Shock is applied in ±X, ±Y, and ±Z directions three times each with and without energizing the Relays to check the number of contact malfunction.

●Contact Reliability Test *1, *2 G6E-134P-US



●High-frequency Characteristics (Isolation) *1, *3 G6E-134P-US (Average value (initial))

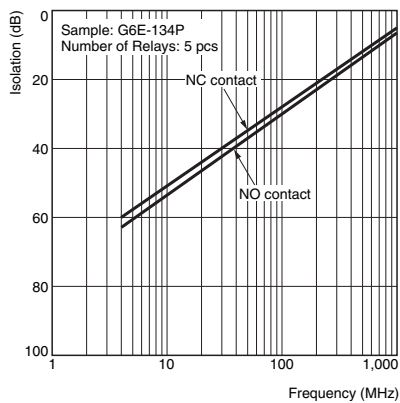

●Contact Reliability Test (70°C) *1, *2 G6E-134P-US



●High-frequency Characteristics (Insertion Loss) *1, *3 G6E-134P-US (Average value (initial))

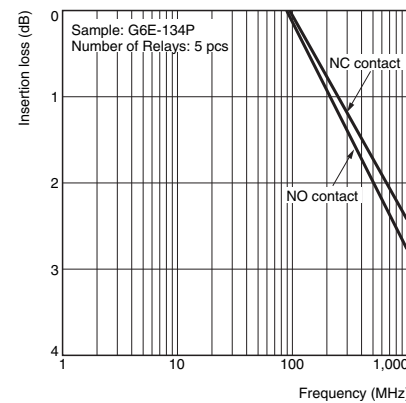

●Mutual Magnetic Interference G6E-134P-US



●Must Operate and Must Release Time Distribution *1 G6E-134P-US

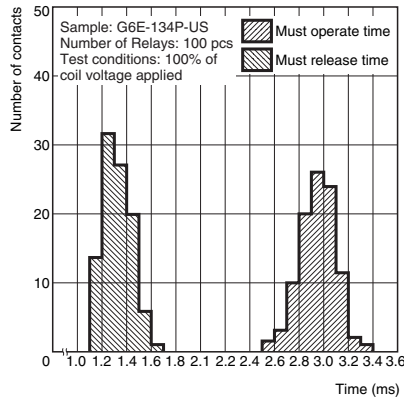

G6E-134PL-US

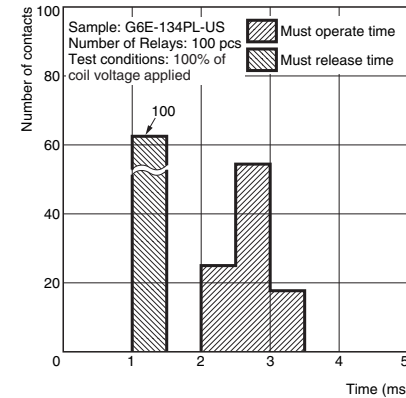

G6E-134P-US 48 VDC

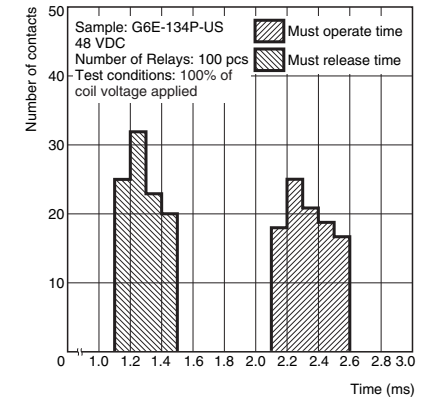

●Distribution of Bounce Time *1 G6E-134P-US

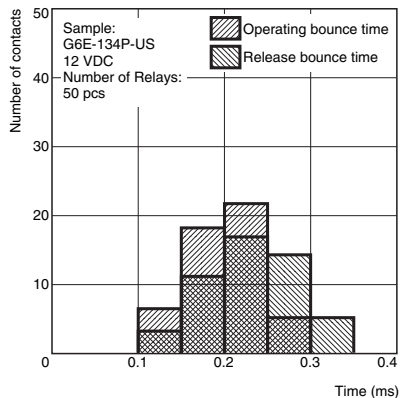

G6E-134PL-US

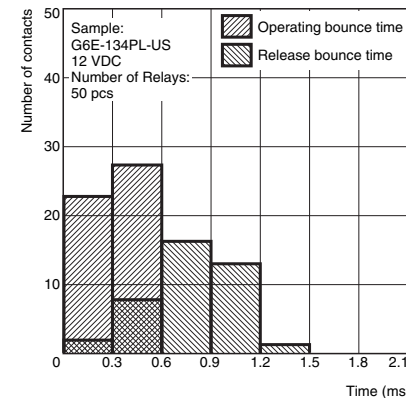

- *1. The tests were conducted at an ambient temperature of 23°C.
- *2. The contact resistance data are periodically measured reference values and are not values from each monitoring operation. Contact resistance values will vary according to the switching frequency and operating environment, so be sure to check operation under the actual operating conditions before use.
- *3. High-frequency characteristics depend on the PCB to which the Relay is mounted. Always check these characteristics, including durability, in the actual machine before use.

■ Dimensions

Single-side stable
G6E-134P-US
G6E-134PL-US
G6E-134P-US-U
G6E-134PL-US-U



PCB Mounting Holes
 (Bottom View)
 Tolerance: ± 0.1

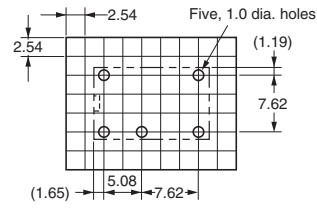

Terminal Arrangement/ Internal Connections
 (Bottom View)

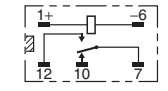

Note: Orientation marks are indicated as follows:

Single-winding latching
G6EU-134P-US
G6EU-134P-US-U



PCB Mounting Holes
 (Bottom View)
 Tolerance: ± 0.1

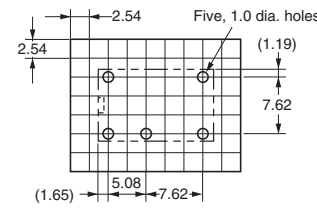

Terminal Arrangement/ Internal Connections
 (Bottom View)

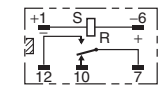

Note: Orientation marks are indicated as follows:

Double-winding latching
G6EK-134P-US
G6EK-134PL-US
G6EK-134P-US-U

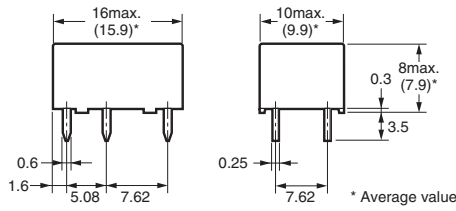

PCB Mounting Holes
 (Bottom View)
 Tolerance: ± 0.1

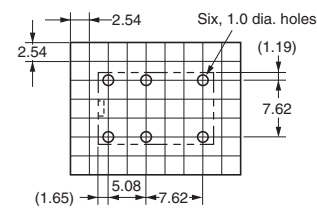

Terminal Arrangement/ Internal Connections
 (Bottom View)

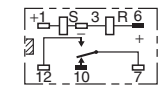

Note: Orientation marks are indicated as follows:

Approved Standards

- The approval rating values for overseas standards are different from the performance values determined individually. Confirm the values before use.

UL recognized:  (File No. E41515)

CSA certified:  (File No. LR31928)

Model	Contact form	Coil ratings	Contact ratings	Number of test operations
G6E()-134P()US	SPDT (1c)	5 to 48 VDC	0.2 A, 250 VAC	6,000
			0.6 A, 125 VAC	
			2 A, 30 VDC	
			0.6 A, 125 VDC	

Precautions

- Please refer to “PCB Relays Common Precautions” for correct use.

Correct Use

Long-term Continuously ON Contacts

- Using the Relay in a circuit where the Relay will be ON continuously for long periods (without switching) can lead to unstable contacts because the heat generated by the coil itself will affect the insulation, causing a film to develop on the contact surfaces. We recommend using a latching relay (magnetic-holding relay) in this kind of circuit. If a single-side stable model must be used in this kind of circuit, we recommend using a fail-safe circuit design that provides protection against contact failure or coil burnout.

Mounting

- Do not reverse the polarity of the coil (+, -).
- Provide sufficient space between Relays when mounting two or more on the same PCB, as shown in the following diagram.

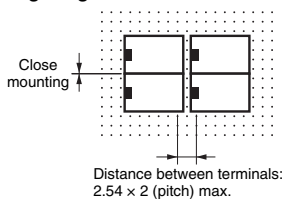

Wiring

- Refer to the following diagram when wiring to switch a DC load. The difference in polarity applied to the contacts will affect the endurance of the Relay due to the amount of contact movement. To extend the endurance characteristics beyond the performance ratings, wire the common (pin 7) terminal to the positive (+) side.

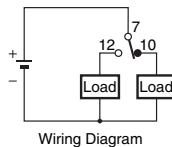

Ultrasonic Cleaning

- Do not use ultrasonic cleaning on standard relay models. Doing so may result in resonance, coil burnout, and contact adhesion within the Relay. Use a model designed for ultrasonic cleaning if ultrasonic cleaning is required.

Relay Handling

- When washing the product after soldering the Relay to a PCB, use a water-based solvent or alcohol-based solvent, and keep the solvent temperature to less than 40°C. Do not put the Relay in a cold cleaning bath immediately after soldering.

Application examples provided in this document are for reference only. In actual applications, confirm equipment functions and safety before using the product. Consult your OMRON representative before using the product under conditions which are not described in the manual or applying the product to nuclear control systems, railroad systems, aviation systems, vehicles, combustion systems, medical equipment, amusement machines, safety equipment, and other systems or equipment that may have a serious influence on lives and property if used improperly. Make sure that the ratings and performance characteristics of the product provide a margin of safety for the system or equipment, and be sure to provide the system or equipment with double safety mechanisms.

Note: Do not use this document to operate the Unit.

Mouser Electronics

Authorized Distributor

Click to View Pricing, Inventory, Delivery & Lifecycle Information:

Omron:

[G6E-134P-ST-US-DC12](#) [G6EK-134P-ST-US-DC24](#) [G6EK-134P-ST-US-DC12](#) [G6EK-134P-ST-US-DC5](#) [G6E-134P-ST-US-DC9](#) [G6E-134P-ST-US-DC5](#) [G6E-134P-ST-US-DC24](#) [G6E-134P-ST-US-DC6](#) [G6E-134PL-ST-US-DC9](#) [G6EU-134P-ST-US-DC3](#) [G6EU-134P-ST-US-DC5](#) [G6EU-134P-ST-US-DC6](#) [G6EU-134P-ST-US-DC9](#) [G6EU-134P-ST-US-DC12](#) [G6EU-134P-ST-US-DC24](#) [G6EK-134P-ST-US-DC3](#) [G6EK-134P-ST-US-DC6](#) [G6EK-134P-ST-US-DC9](#) [G6EK-134PL-ST-US-DC3](#) [G6EK-134PL-ST-US-DC5](#) [G6EK-134PL-ST-US-DC6](#) [G6EK-134PL-ST-US-DC12](#) [G6EK-134PL-ST-US-DC24](#) [G6E-134PL-US DC48](#) [G6E-134P-ST-US-H-DC48](#) [G6EK-134P-ST-US DC1.5](#) [G6EU-134PL-ST-US-DC12](#) [G6EU-134PL-ST-US-DC24](#) [G6EU-134PL-ST-US-DC5](#) [G6E-134P-ST-US DC3](#) [G6E-134P-ST-US-DC48](#) [G6E-134P-US DC48](#) [G6E-134P-US DC5](#) [G6E-134PL-ST-US DC3](#) [G6E-134P-US DC24](#) [G6E-134P-US DC12](#) [G6E-134PL-ST-US-DC5](#) [G6E-134PL-ST-US-DC12](#) [G6E-134PL-ST-US-DC24](#) [G6EK-134P-ST-1-US DC3](#) [G6E-194P-ST-US DC12](#) [G6EU-134P-US DC6](#) [G6E-134P-US DC9](#) [G6EU-134P-US DC5](#) [G6E-134P-US DC3](#) [G6EU-134P-US DC24](#)



Компания «ЭлектроПласт» предлагает заключение долгосрочных отношений при поставках импортных электронных компонентов на взаимовыгодных условиях!

Наши преимущества:

- Оперативные поставки широкого спектра электронных компонентов отечественного и импортного производства напрямую от производителей и с крупнейших мировых складов;
- Поставка более 17-ти миллионов наименований электронных компонентов;
- Поставка сложных, дефицитных, либо снятых с производства позиций;
- Оперативные сроки поставки под заказ (от 5 рабочих дней);
- Экспресс доставка в любую точку России;
- Техническая поддержка проекта, помощь в подборе аналогов, поставка прототипов;
- Система менеджмента качества сертифицирована по Международному стандарту ISO 9001;
- Лицензия ФСБ на осуществление работ с использованием сведений, составляющих государственную тайну;
- Поставка специализированных компонентов (Xilinx, Altera, Analog Devices, Intersil, Interpoint, Microsemi, Aeroflex, Peregrine, Syfer, Eurofarad, Texas Instrument, Miteq, Cobham, E2V, MA-COM, Hittite, Mini-Circuits, General Dynamics и др.);

Помимо этого, одним из направлений компании «ЭлектроПласт» является направление «Источники питания». Мы предлагаем Вам помощь Конструкторского отдела:

- Подбор оптимального решения, техническое обоснование при выборе компонента;
- Подбор аналогов;
- Консультации по применению компонента;
- Поставка образцов и прототипов;
- Техническая поддержка проекта;
- Защита от снятия компонента с производства.



Как с нами связаться

Телефон: 8 (812) 309 58 32 (многоканальный)

Факс: 8 (812) 320-02-42

Электронная почта: org@eplast1.ru

Адрес: 198099, г. Санкт-Петербург, ул. Калинина, дом 2, корпус 4, литера А.