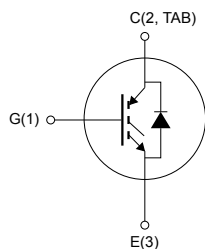
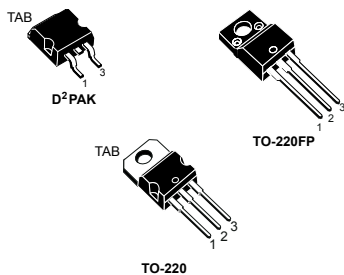


## Trench gate field-stop IGBT, H series 600 V, 14 A high speed



NG1E3C2T

### Features

- High speed switching
- Tight parameters distribution
- Safe paralleling
- Low thermal resistance
- Short-circuit rated
- Ultrafast soft recovery antiparallel diode

### Applications

- Motor control
- UPS, PFC

### Description

These devices are IGBTs developed using an advanced proprietary trench gate field-stop structure. These devices are part of the H series of IGBTs, which represents an optimum compromise between conduction and switching losses to maximize the efficiency of high switching frequency converters. Furthermore, a slightly positive  $V_{CE(sat)}$  temperature coefficient and very tight parameter distribution result in safer paralleling operation.

#### Product status link

[STGB15H60DF](#)
[STGF15H60DF](#)
[STGP15H60DF](#)

# 1 Electrical ratings

**Table 1. Absolute maximum ratings**

Symbol	Parameter	Value		Unit
		D <sup>2</sup> PAK, TO-220	TO-220FP	
V <sub>CES</sub>	Collector-emitter voltage (V <sub>GE</sub> = 0 V)	600		V
I <sub>C</sub>	Continuous collector current at T <sub>C</sub> = 25 °C	30	30 <sup>(1)</sup>	A
	Continuous collector current at T <sub>C</sub> = 100 °C	15	15 <sup>(1)</sup>	
I <sub>CP</sub> <sup>(2)</sup>	Pulsed collector current	60	60	A
V <sub>GE</sub>	Gate-emitter voltage	±20		V
I <sub>F</sub>	Continuous forward current T <sub>C</sub> = 25 °C	30	30 <sup>(1)</sup>	A
	Continuous forward current at T <sub>C</sub> = 100 °C	15	15 <sup>(1)</sup>	
I <sub>FP</sub> <sup>(2)</sup>	Pulsed forward current	60	60	A
V <sub>ISO</sub>	Insulation withstand voltage (RMS) from all three leads to external heat sink (t = 1 s; T <sub>C</sub> = 25 °C)		2500	V
P <sub>TOT</sub>	Total power dissipation at T <sub>C</sub> = 25 °C	115	30	W
T <sub>STG</sub>	Storage temperature range	-55 to 150		°C
T <sub>J</sub>	Operating junction temperature range	-55 to 175		

1. Limited by maximum junction temperature.
2. Pulse width limited by maximum junction temperature.

**Table 2. Thermal data**

Symbol	Parameter	Value		Unit
		D <sup>2</sup> PAK, TO-220	TO-220FP	
R <sub>thJC</sub>	Thermal resistance junction-case IGBT	1.3	5	°C/W
R <sub>thJC</sub>	Thermal resistance junction-case diode	2.78	6.25	°C/W
R <sub>thJA</sub>	Thermal resistance junction-ambient	62.5	62.5	°C/W

## 2 Electrical characteristics

$T_C = 25\text{ °C}$  unless otherwise specified.

**Table 3. Static**

Symbol	Parameter	Test conditions	Min.	Typ.	Max.	Unit
$V_{(BR)CES}$	Collector-emitter breakdown voltage	$V_{GE} = 0\text{ V}$ , $I_C = 2\text{ mA}$	600			V
$V_{CE(sat)}$	Collector-emitter saturation voltage	$V_{GE} = 15\text{ V}$ , $I_C = 15\text{ A}$		1.6	2.0	V
		$V_{GE} = 15\text{ V}$ , $I_C = 15\text{ A}$ $T_J = 125\text{ °C}$		1.7		
		$V_{GE} = 15\text{ V}$ , $I_C = 15\text{ A}$ $T_J = 175\text{ °C}$		1.8		
$V_{GE(th)}$	Gate threshold voltage	$V_{CE} = V_{GE}$ , $I_C = 1\text{ mA}$	5.0	6.0	7.0	V
$I_{CES}$	Collector cut-off current	$V_{CE} = 600\text{ V}$ $V_{GE} = 0\text{ V}$			25	$\mu\text{A}$
$I_{GES}$	Gate-emitter leakage current	$V_{GE} = \pm 20\text{ V}$ $V_{CE} = 0\text{ V}$			$\pm 250$	nA

**Table 4. Dynamic**

Symbol	Parameter	Test conditions	Min.	Typ.	Max.	Unit
$C_{ies}$	Input capacitance	$V_{CE} = 25\text{ V}$ , $f = 1\text{ MHz}$ , $V_{GE} = 0\text{ V}$	-	1952	-	$\mu\text{F}$
$C_{oes}$	Output capacitance			78		
$C_{res}$	Reverse transfer capacitance			45		
$Q_g$	Total gate charge	$V_{CC} = 480\text{ V}$ , $I_C = 15\text{ A}$ , $V_{GE} = 0\text{ to }15\text{ V}$ (see <a href="#">Figure 33. Gate charge test circuit</a> )	-	81	-	nC
$Q_{ge}$	Gate-emitter charge			8		
$Q_{gc}$	Gate-collector charge			42		

**Table 5. Switching characteristics (inductive load)**

Symbol	Parameter	Test conditions	Min.	Typ.	Max.	Unit
$t_{d(on)}$	Turn-on delay time	$V_{CE} = 400\text{ V}$ , $I_C = 15\text{ A}$ , $R_G = 10\text{ }\Omega$ , $V_{GE} = 15\text{ V}$ (see <a href="#">Figure 32. Test circuit for inductive load switching and Figure 34. Switching waveform</a> )		24.5	-	ns
$t_r$	Current rise time			8.2		
$(di/dt)_{on}$	Turn-on current slope			1470		
$t_{d(on)}$	Turn-on delay time	$V_{CE} = 400\text{ V}$ , $I_C = 15\text{ A}$ , $R_G = 10\text{ }\Omega$ , $V_{GE} = 15\text{ V}$ $T_J = 175\text{ °C}$ (see <a href="#">Figure 32. Test circuit for inductive load switching and Figure 34. Switching waveform</a> )		25	-	ns
$t_r$	Current rise time			9		
$(di/dt)_{on}$	Turn-on current slope			1370		

Symbol	Parameter	Test conditions	Min.	Typ.	Max.	Unit
$t_{r(Voff)}$	Off voltage rise time	$V_{CE} = 400\text{ V}$ , $I_C = 15\text{ A}$ , $R_G = 10\ \Omega$ , $V_{GE} = 15\text{ V}$ (see Figure 32. Test circuit for inductive load switching and Figure 34. Switching waveform)		18		ns
$t_{d(off)}$	Turn-off delay time			118		
$t_f$	Current fall time			69		
$t_{r(Voff)}$	Off voltage rise time	$V_{CE} = 400\text{ V}$ , $I_C = 15\text{ A}$ ,		27	-	ns
$t_{d(off)}$	Turn-off delay time	$R_G = 10\ \Omega$ , $V_{GE} = 15\text{ V}$		124		
$t_f$	Current fall time	$T_J = 175\text{ }^\circ\text{C}$ (see Figure 32. Test circuit for inductive load switching and Figure 34. Switching waveform)		101		
$t_{sc}$	Short-circuit withstand time	$V_{CC} \leq 360\text{ V}$ , $V_{GE} = 15\text{ V}$ , $R_G = 10\ \Omega$	3	5	-	$\mu\text{s}$

**Table 6. Switching energy (inductive load)**

Symbol	Parameter	Test conditions	Min.	Typ.	Max.	Unit
$E_{on}^{(1)}$	Turn-on switching energy	$V_{CE} = 400\text{ V}$ , $I_C = 15\text{ A}$ , $R_G = 10\ \Omega$ , $V_{GE} = 15\text{ V}$ (see Figure 32. Test circuit for inductive load switching)		136		$\mu\text{J}$
$E_{off}^{(2)}$	Turn-off switching energy			207		
$E_{is}$	Total switching energy			343		
$E_{on}^{(1)}$	Turn-on switching energy	$V_{CE} = 400\text{ V}$ , $I_C = 15\text{ A}$ ,	-	224	-	$\mu\text{J}$
$E_{off}^{(2)}$	Turn-off switching energy	$R_G = 10\ \Omega$ , $V_{GE} = 15\text{ V}$		329		
$E_{is}$	Total switching energy	$T_J = 175\text{ }^\circ\text{C}$ (see Figure 32. Test circuit for inductive load switching)		553		

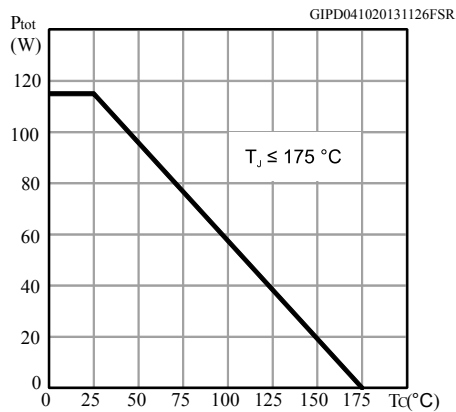
1. Including the reverse recovery of the diode.
2. Including the tail of the collector current.

**Table 7. Collector-emitter diode**

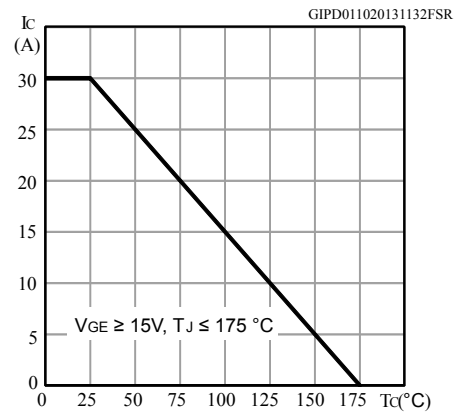
Symbol	Parameter	Test conditions	Min.	Typ.	Max.	Unit
$V_F$	Forward on-voltage	$I_F = 15\text{ A}$	-	1.8	2.2	V
		$I_F = 15\text{ A}$ , $T_J = 175\text{ }^\circ\text{C}$		1.3		
$t_{rr}$	Reverse recovery time	$V_r = 60\text{ V}$ ; $I_F = 15\text{ A}$ ;		103		ns
$Q_{rr}$	Reverse recovery charge	$di_F/dt = 100\text{ A}/\mu\text{s}$ (see Figure 35. Diode reverse recovery waveform)		128		nC
$I_{rrm}$	Reverse recovery current			2.5		A
$t_{rr}$	Reverse recovery time	$V_r = 60\text{ V}$ ; $I_F = 15\text{ A}$ ;	-	182		ns
$Q_{rr}$	Reverse recovery charge	$di_F/dt = 100\text{ A}/\mu\text{s}$		437		nC
$I_{rrm}$	Reverse recovery current	$T_J = 175\text{ }^\circ\text{C}$ (see Figure 35. Diode reverse recovery waveform)		4.8		A

## 2.1 Electrical characteristics (curves)

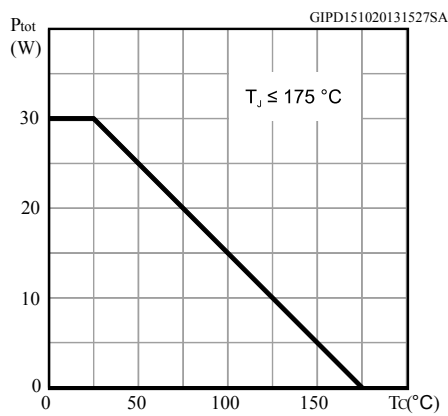
**Figure 1. Power dissipation vs case temperature for D<sup>2</sup>PAK and TO-220**



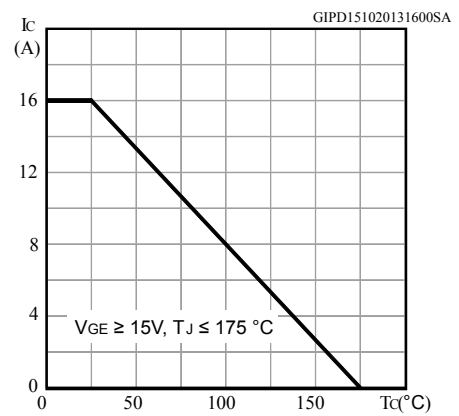
**Figure 2. Collector current vs case temperature for D<sup>2</sup>PAK and TO-220**



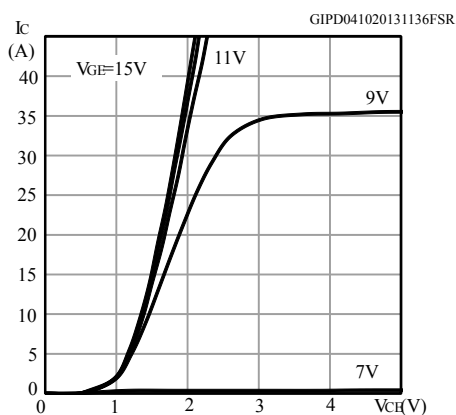
**Figure 3. Power dissipation vs case temperature for TO-220FP**



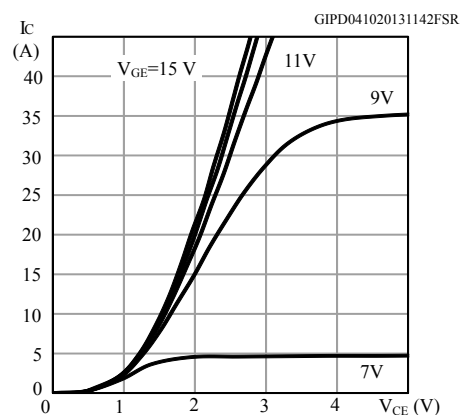
**Figure 4. Collector current vs case temperature for TO-220FP**

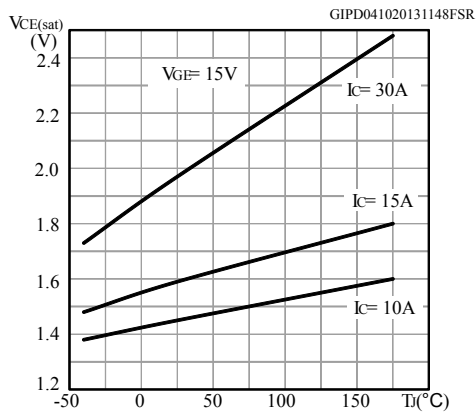
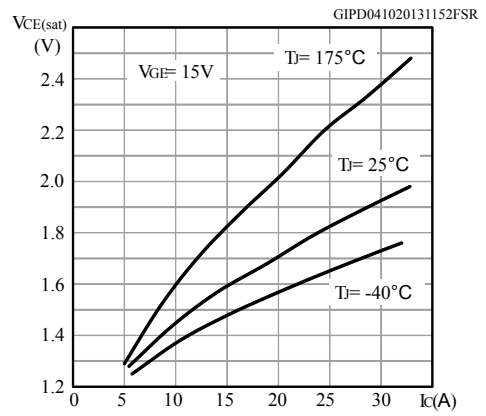
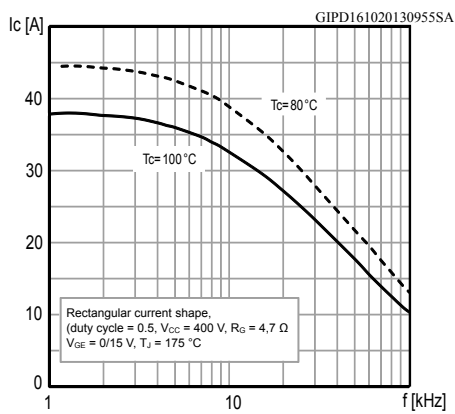
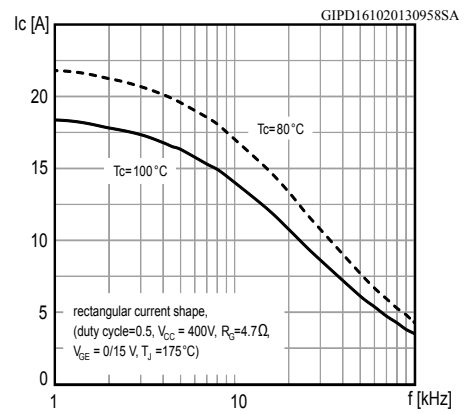
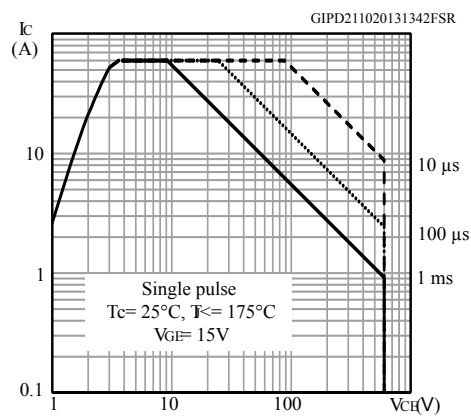
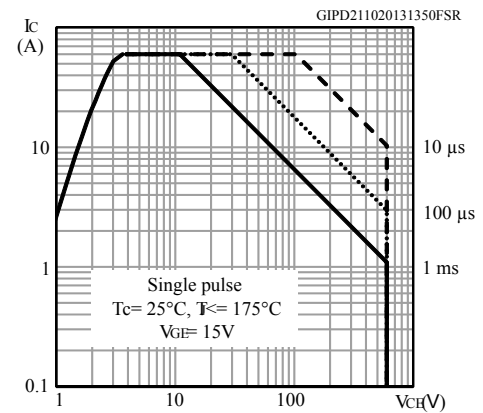


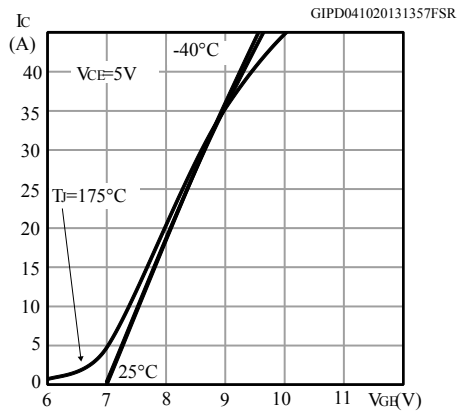
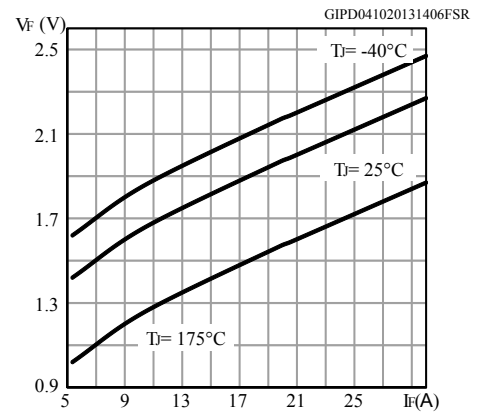
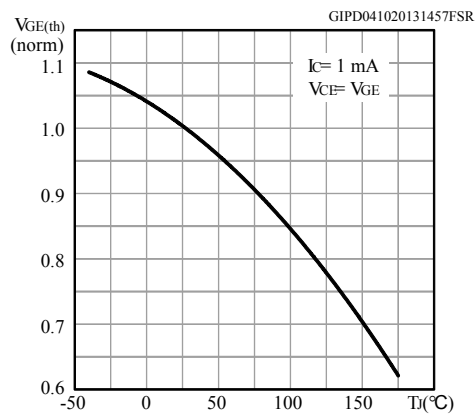
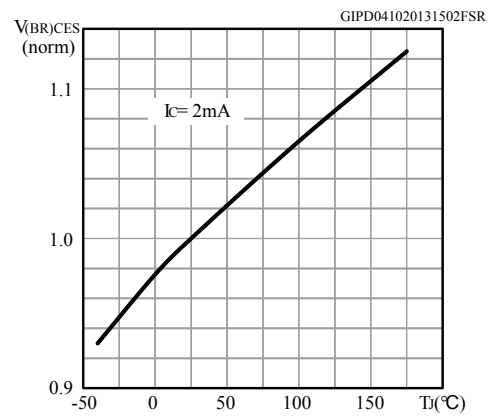
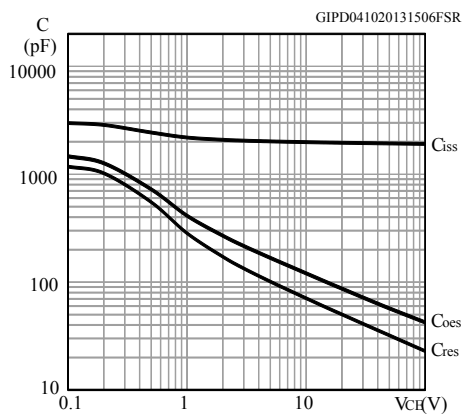
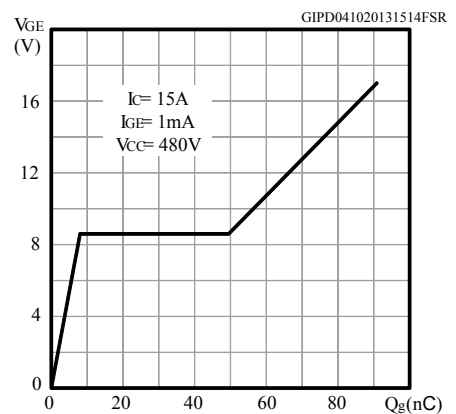
**Figure 5. Output characteristics (T<sub>J</sub> = 25°C)**

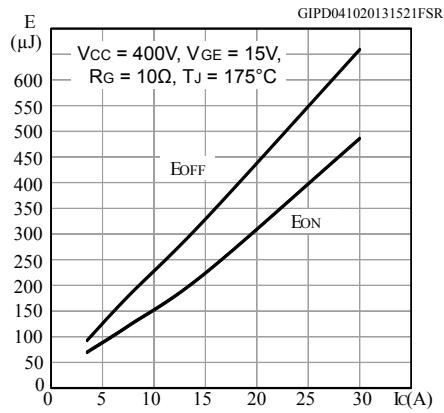
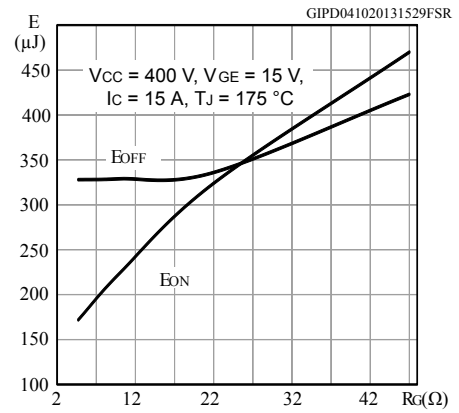
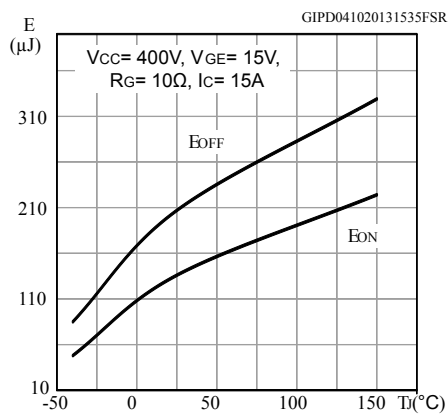
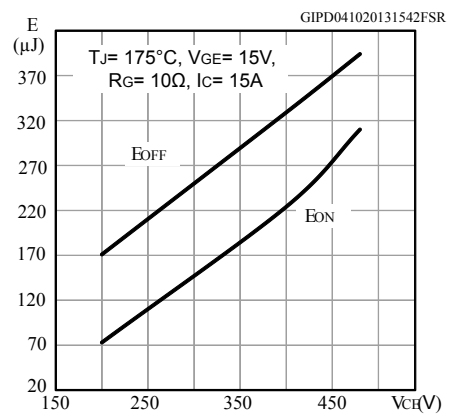
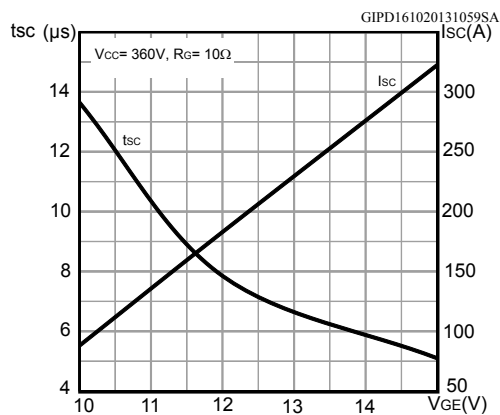
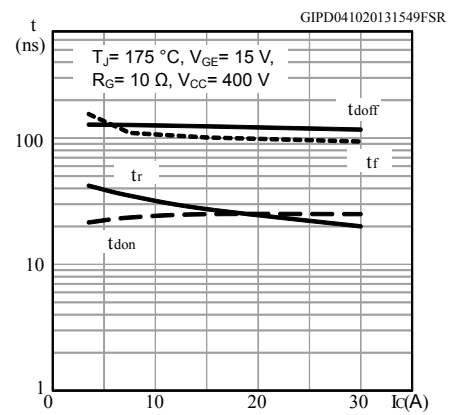


**Figure 6. Output characteristics (T<sub>J</sub> = 175°C)**

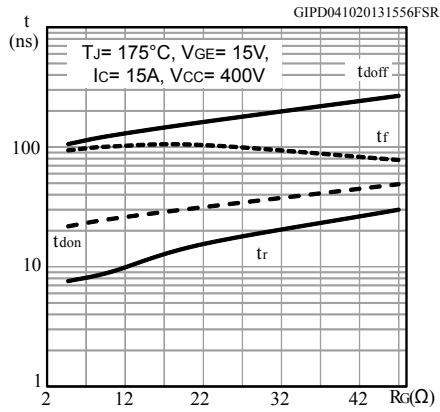
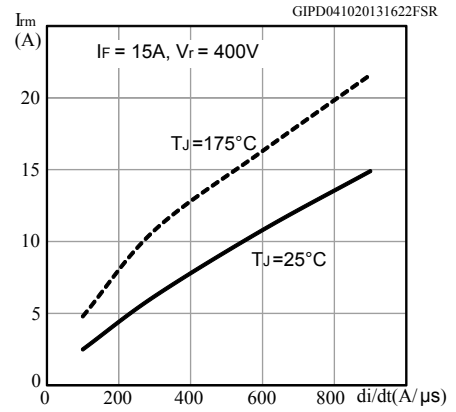
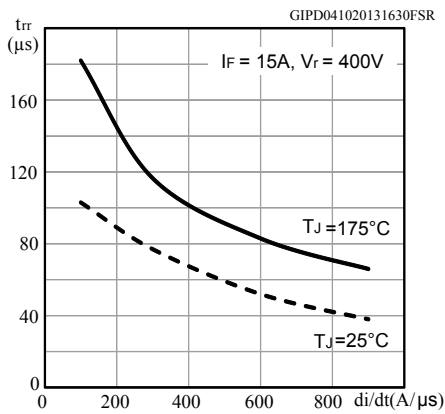
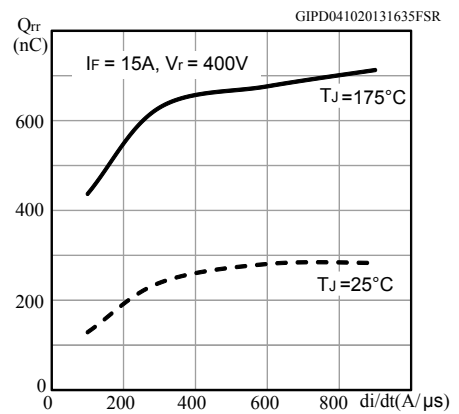
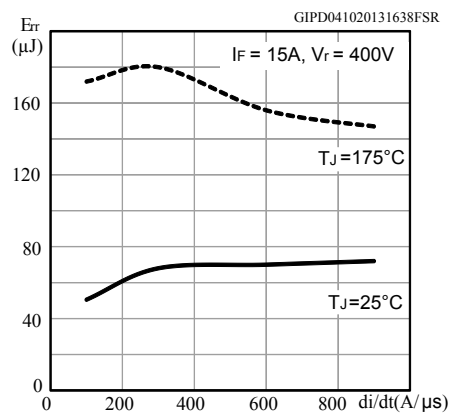


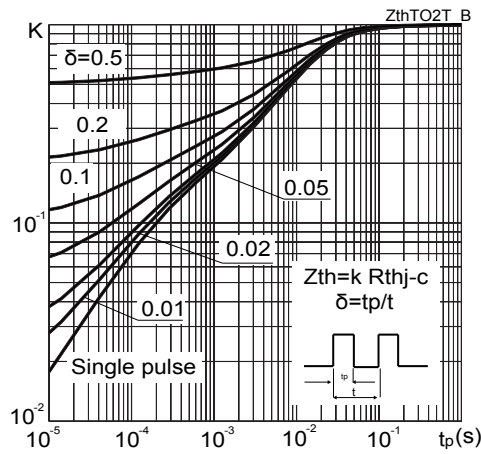
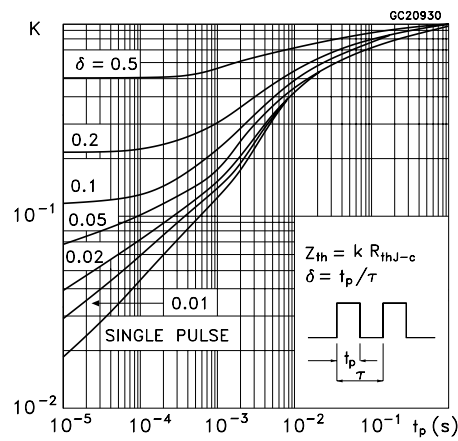
**Figure 7.  $V_{CE(sat)}$  vs junction temperature**

**Figure 8.  $V_{CE(sat)}$  vs collector current**

**Figure 9. Collector current vs switching frequency for D<sup>2</sup>PAK and TO-220**

**Figure 10. Collector current vs switching frequency for TO-220FP**

**Figure 11. Forward bias safe operating area for D<sup>2</sup>PAK and TO-220**

**Figure 12. Forward bias safe operating area for TO-220FP**


**Figure 13. Transfer characteristics**

**Figure 14. Diode  $V_F$  vs forward current**

**Figure 15. Normalized  $V_{GE(th)}$  vs junction temperature**

**Figure 16. Normalized  $V_{(BR)CES}$  vs junction temperature**

**Figure 17. Capacitance variation**

**Figure 18. Gate charge vs gate-emitter voltage**


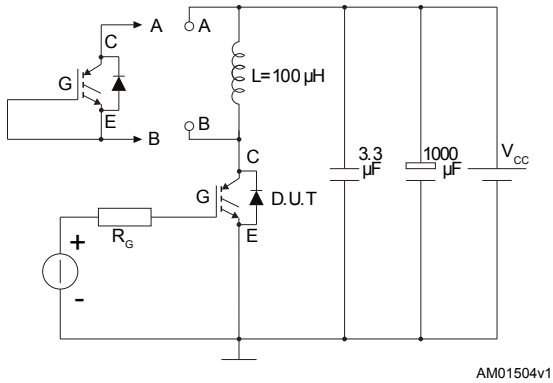
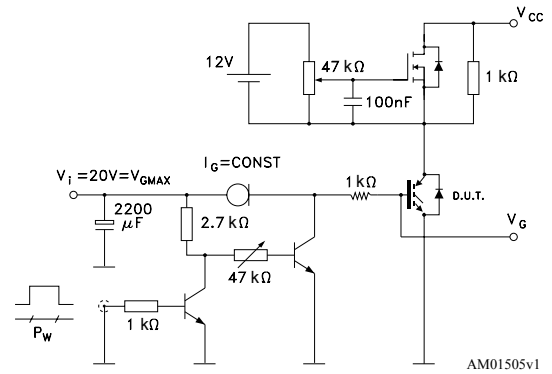
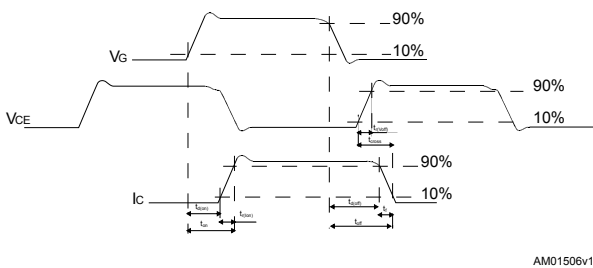
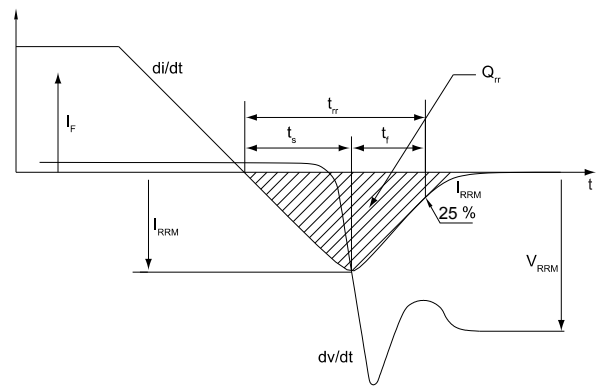
**Figure 19. Switching energy vs collector current**

**Figure 20. Switching energy vs gate resistance**

**Figure 21. Switching energy vs temperature**

**Figure 22. Switching energy vs collector-emitter voltage**

**Figure 23. Short-circuit time and current vs VGE**

**Figure 24. Switching times vs collector current**




**Figure 25. Switching times vs gate resistance**

**Figure 26. Reverse recovery current vs diode current slope**

**Figure 27. Reverse recovery time vs diode current slope**

**Figure 28. Reverse recovery charge vs diode current slope**

**Figure 29. Reverse recovery energy vs diode current slope**


**Figure 30. Thermal impedance for IGBT**

**Figure 31. Thermal impedance for diode**


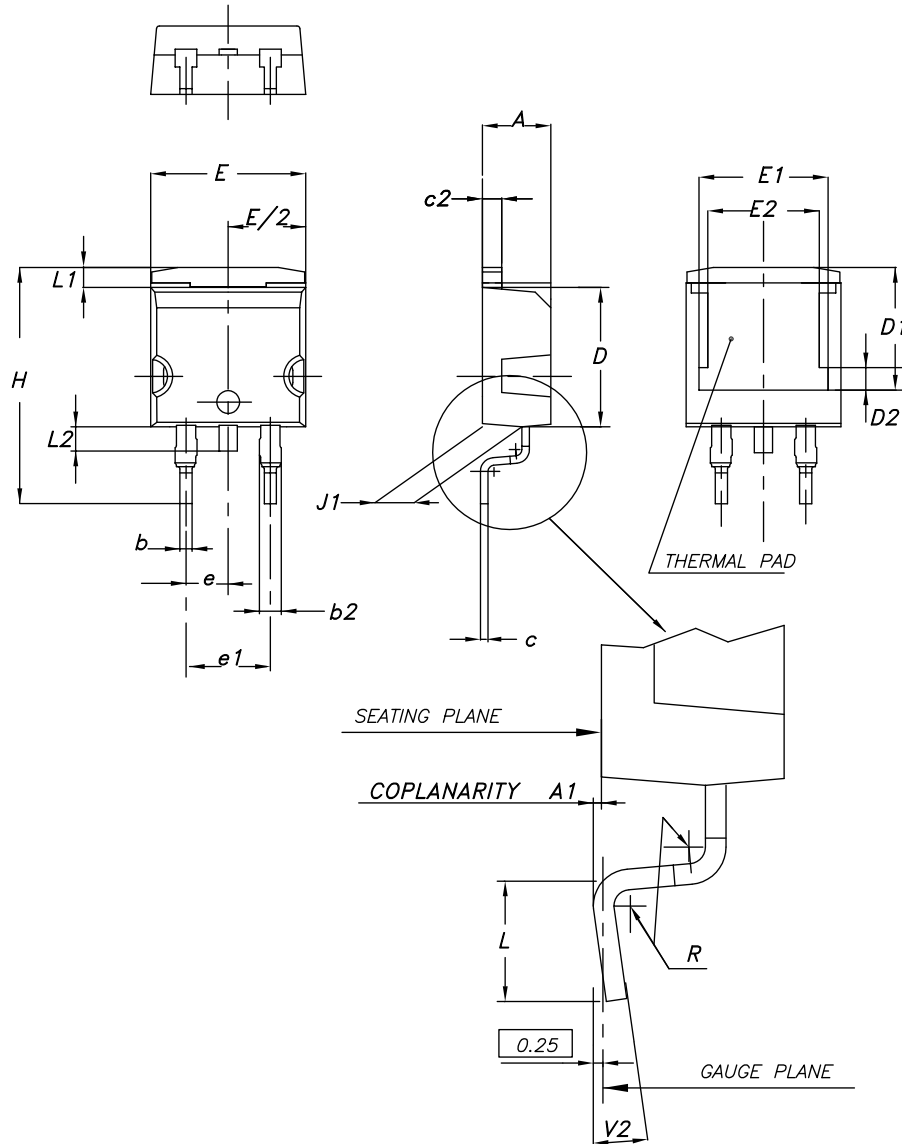
### 3 Test circuits

**Figure 32. Test circuit for inductive load switching**

**Figure 33. Gate charge test circuit**

**Figure 34. Switching waveform**

**Figure 35. Diode reverse recovery waveform**


## 4 Package information

---

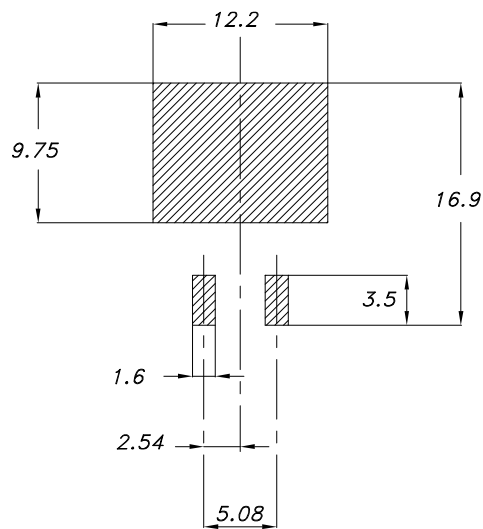
In order to meet environmental requirements, ST offers these devices in different grades of **ECOPACK** packages, depending on their level of environmental compliance. ECOPACK specifications, grade definitions and product status are available at: [www.st.com](http://www.st.com). ECOPACK is an ST trademark.

**4.1 D<sup>2</sup>PAK (TO-263) type A2 package information**
**Figure 36. D<sup>2</sup>PAK (TO-263) type A2 package outline**


0079457\_A2\_25

**Table 8. D<sup>2</sup>PAK (TO-263) type A2 package mechanical data**

Dim.	mm		
	Min.	Typ.	Max.
A	4.40		4.60
A1	0.03		0.23
b	0.70		0.93
b2	1.14		1.70
c	0.45		0.60
c2	1.23		1.36
D	8.95		9.35
D1	7.50	7.75	8.00
D2	1.10	1.30	1.50
E	10.00		10.40
E1	8.70	8.90	9.10
E2	7.30	7.50	7.70
e		2.54	
e1	4.88		5.28
H	15.00		15.85
J1	2.49		2.69
L	2.29		2.79
L1	1.27		1.40
L2	1.30		1.75
R		0.40	
V2	0°		8°

**Figure 37. D<sup>2</sup>PAK (TO-263) recommended footprint (dimensions are in mm)**


Footprint

## 4.2 D<sup>2</sup>PAK packing information

Figure 38. D<sup>2</sup>PAK tape outline



AM08852v1

**Figure 39. D<sup>2</sup>PAK reel outline**


AM06038v1

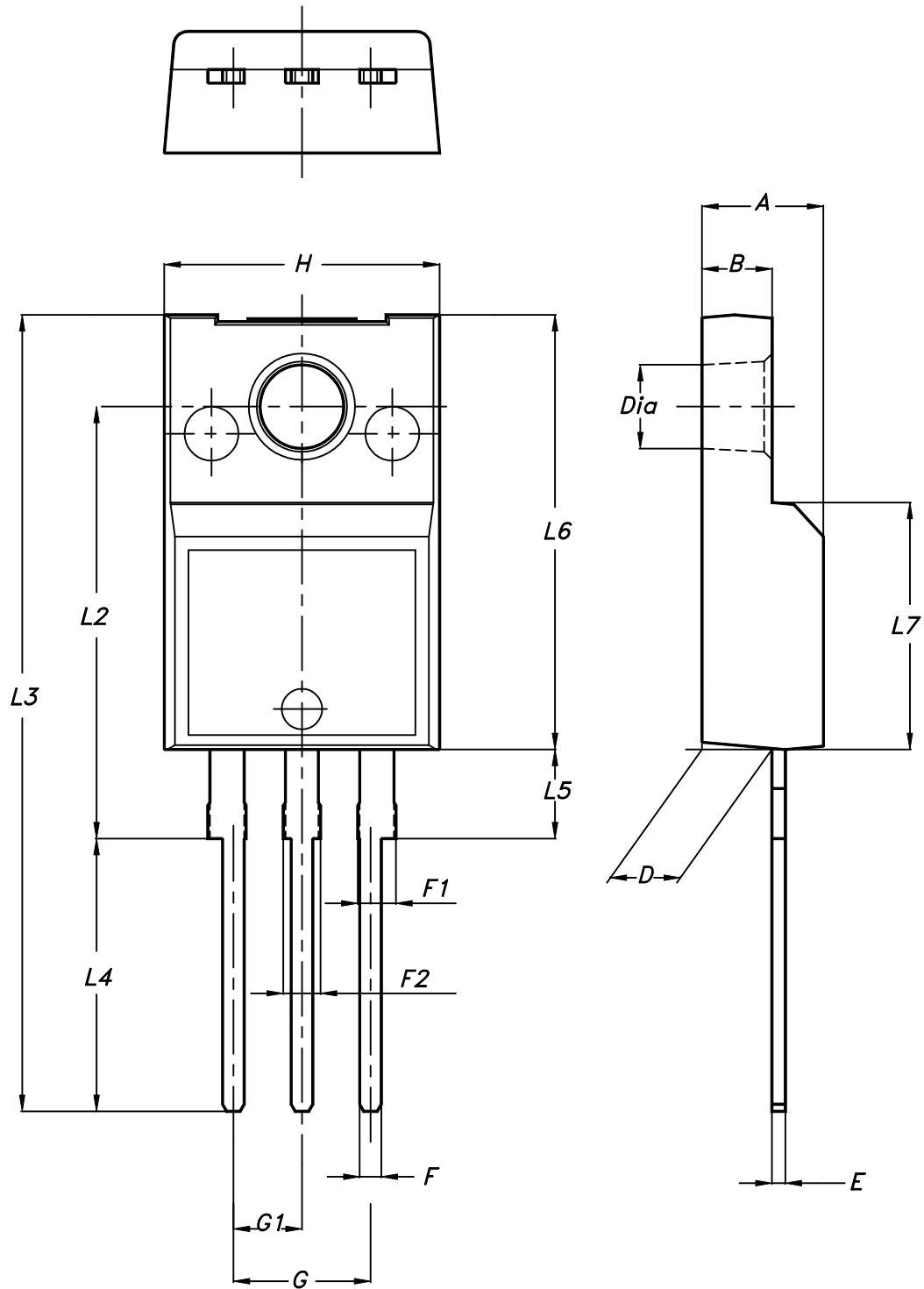
**Table 9. D<sup>2</sup>PAK tape and reel mechanical data**

Tape			Reel		
Dim.	mm		Dim.	mm	
	Min.	Max.		Min.	Max.
A0	10.5	10.7	A		330
B0	15.7	15.9	B	1.5	
D	1.5	1.6	C	12.8	13.2
D1	1.59	1.61	D	20.2	
E	1.65	1.85	G	24.4	26.4
F	11.4	11.6	N	100	
K0	4.8	5.0	T		30.4
P0	3.9	4.1			
P1	11.9	12.1	Base quantity		1000
P2	1.9	2.1	Bulk quantity		1000
R	50				
T	0.25	0.35			
W	23.7	24.3			



### 4.3 TO-220FP package information

Figure 40. TO-220FP package outline



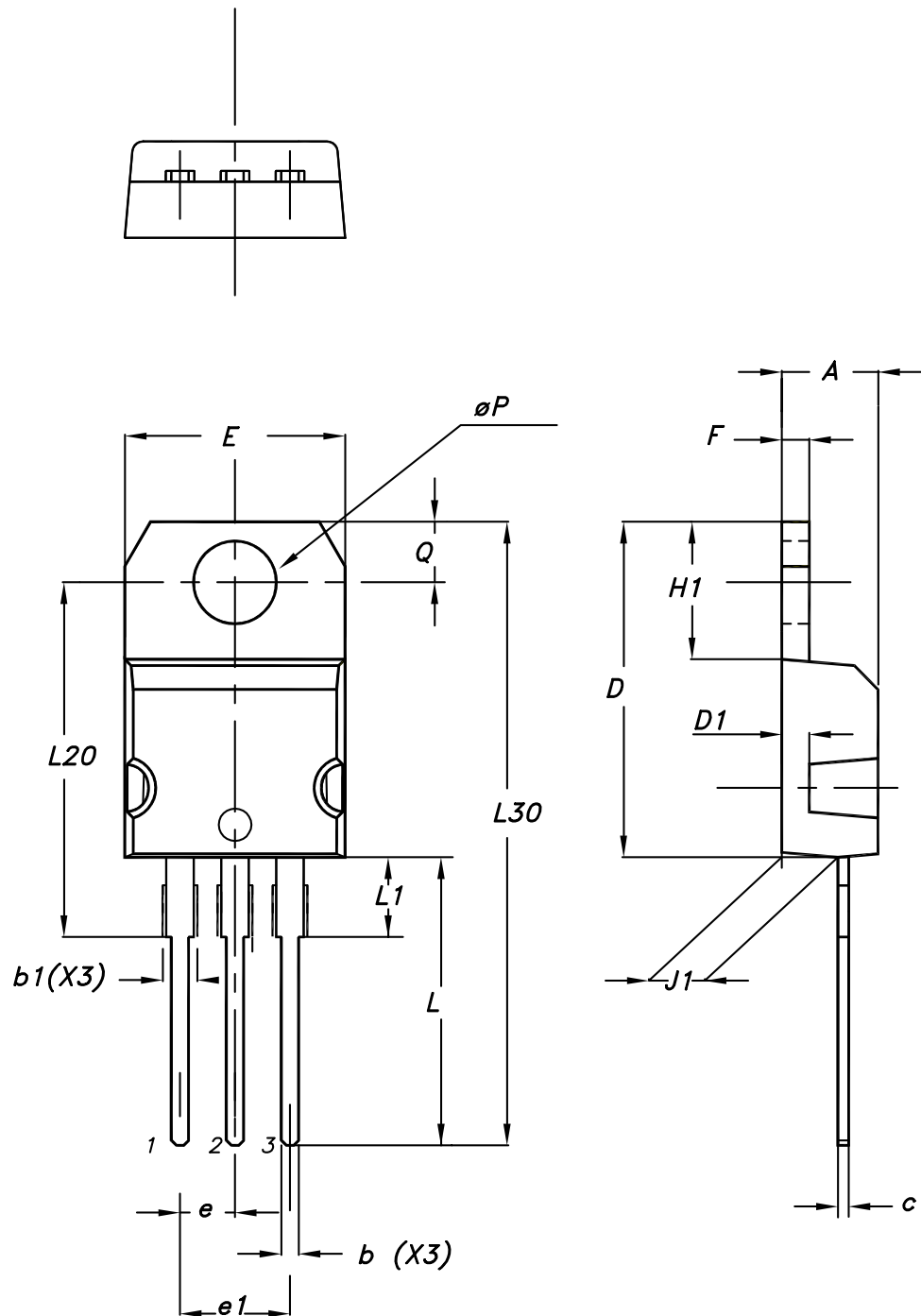
7012510\_Rev\_12\_B

**Table 10. TO-220FP package mechanical data**

Dim.	mm		
	Min.	Typ.	Max.
A	4.4		4.6
B	2.5		2.7
D	2.5		2.75
E	0.45		0.7
F	0.75		1
F1	1.15		1.70
F2	1.15		1.70
G	4.95		5.2
G1	2.4		2.7
H	10		10.4
L2		16	
L3	28.6		30.6
L4	9.8		10.6
L5	2.9		3.6
L6	15.9		16.4
L7	9		9.3
Dia	3		3.2

#### 4.4 TO-220 type A package information

Figure 41. TO-220 type A package outline



0015988\_typeA\_Rev\_22

**Table 11. TO-220 type A package mechanical data**

Dim.	mm		
	Min.	Typ.	Max.
A	4.40		4.60
b	0.61		0.88
b1	1.14		1.55
c	0.48		0.70
D	15.25		15.75
D1		1.27	
E	10.00		10.40
e	2.40		2.70
e1	4.95		5.15
F	1.23		1.32
H1	6.20		6.60
J1	2.40		2.72
L	13.00		14.00
L1	3.50		3.93
L20		16.40	
L30		28.90	
øP	3.75		3.85
Q	2.65		2.95

## 5 Ordering information

**Table 12. Order codes**

Order code	Marking	Package	Packing
STGB15H60DF	GB15H60DF	D <sup>2</sup> PAK	Tape and reel
STGF15H60DF	GF15H60DF	TO-220FP	Tube
STGP15H60DF	GP15H60DF	TO-220	

## Revision history

**Table 13. Document revision history**

Date	Version	Changes
12-Aug-2013	1	Initial release.
17-Oct-2013	2	Document status promoted from preliminary to production data. Added <i>Section 2.1: Electrical characteristics (curves)</i> . Minor text changes.
09-Apr-2019	3	Updated applications and description on cover page. Updated <a href="#">Section 4 Package information</a> . Minor text changes.

## Contents

<b>1</b>	<b>Electrical ratings</b> .....	<b>2</b>
<b>2</b>	<b>Electrical characteristics</b> .....	<b>3</b>
<b>2.1</b>	Electrical characteristics (curves) .....	5
<b>3</b>	<b>Test circuits</b> .....	<b>11</b>
<b>4</b>	<b>Package information</b> .....	<b>12</b>
<b>4.1</b>	D <sup>2</sup> PAK (TO-263) type A2 package information .....	12
<b>4.2</b>	D <sup>2</sup> PAK packing information .....	14
<b>4.3</b>	TO-220FP package information .....	16
<b>4.4</b>	TO-220 type A package information .....	18
<b>5</b>	<b>Ordering information</b> .....	<b>21</b>
	<b>Revision history</b> .....	<b>22</b>

**IMPORTANT NOTICE – PLEASE READ CAREFULLY**

STMicroelectronics NV and its subsidiaries (“ST”) reserve the right to make changes, corrections, enhancements, modifications, and improvements to ST products and/or to this document at any time without notice. Purchasers should obtain the latest relevant information on ST products before placing orders. ST products are sold pursuant to ST’s terms and conditions of sale in place at the time of order acknowledgement.

Purchasers are solely responsible for the choice, selection, and use of ST products and ST assumes no liability for application assistance or the design of Purchasers’ products.

No license, express or implied, to any intellectual property right is granted by ST herein.

Resale of ST products with provisions different from the information set forth herein shall void any warranty granted by ST for such product.

ST and the ST logo are trademarks of ST. For additional information about ST trademarks, please refer to [www.st.com/trademarks](http://www.st.com/trademarks). All other product or service names are the property of their respective owners.

Information in this document supersedes and replaces information previously supplied in any prior versions of this document.

© 2019 STMicroelectronics – All rights reserved





Компания «ЭлектроПласт» предлагает заключение долгосрочных отношений при поставках импортных электронных компонентов на взаимовыгодных условиях!

Наши преимущества:

- Оперативные поставки широкого спектра электронных компонентов отечественного и импортного производства напрямую от производителей и с крупнейших мировых складов;
- Поставка более 17-ти миллионов наименований электронных компонентов;
- Поставка сложных, дефицитных, либо снятых с производства позиций;
- Оперативные сроки поставки под заказ (от 5 рабочих дней);
- Экспресс доставка в любую точку России;
- Техническая поддержка проекта, помощь в подборе аналогов, поставка прототипов;
- Система менеджмента качества сертифицирована по Международному стандарту ISO 9001;
- Лицензия ФСБ на осуществление работ с использованием сведений, составляющих государственную тайну;
- Поставка специализированных компонентов (Xilinx, Altera, Analog Devices, Intersil, Interpoint, Microsemi, Aeroflex, Peregrine, Syfer, Eurofarad, Texas Instrument, Miteq, Cobham, E2V, MA-COM, Hittite, Mini-Circuits, General Dynamics и др.);

Помимо этого, одним из направлений компании «ЭлектроПласт» является направление «Источники питания». Мы предлагаем Вам помощь Конструкторского отдела:

- Подбор оптимального решения, техническое обоснование при выборе компонента;
- Подбор аналогов;
- Консультации по применению компонента;
- Поставка образцов и прототипов;
- Техническая поддержка проекта;
- Защита от снятия компонента с производства.



#### Как с нами связаться

**Телефон:** 8 (812) 309 58 32 (многоканальный)

**Факс:** 8 (812) 320-02-42

**Электронная почта:** [org@eplast1.ru](mailto:org@eplast1.ru)

**Адрес:** 198099, г. Санкт-Петербург, ул. Калинина, дом 2, корпус 4, литера А.