

# General Purpose Relay LY

- Arc barrier equipped.
- High dielectric strength (2,000 VAC).
- Long dependable service life assured by Ag-Alloy contacts.
- Choose models with single or bifurcated contacts, LED indicator, diode surge suppression, push-to-test button, or RC circuit.
- UL, CSA, and TUV approvals on all standard LY Relays.
- CE marks included on non-PCB mount versions.

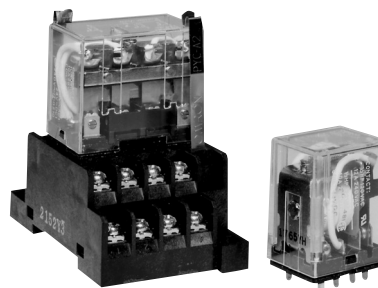

## Ordering Information

To Order: Select the part number and add the desired coil voltage rating (e.g., LY1-DC6).

Type	Terminal	Contact form	Model			
			Single contact		Bifurcated contact	
			Standard bracket mounting	Upper mounting bracket	Standard bracket mounting	Upper mounting bracket
Standard	Plug-in/solder	SPDT	LY1	LY1F	—	—
		DPDT	LY2	LY2F	LY2Z	LY2ZF
		3PDT	LY3	LY3F	—	—
		4PDT	LY4	LY4F	—	—
	PCB	SPDT	LY1-0	—	—	—
		DPDT	LY2-0	—	LY2Z-0	—
		3PDT	LY3-0	—	—	—
		4PDT	LY4-0	—	—	—
LED indicator	Plug-in/solder	SPDT	LY1N	—	—	—
		DPDT	LY2N	—	LY2ZN	—
		3PDT	LY3N	—	—	—
		4PDT	LY4N	—	—	—
Diode surge suppression	Plug-in/solder	SPDT	LY1-D	—	—	—
		DPDT	LY2-D	—	LY2Z-D	—
		3PDT	LY3-D	—	—	—
		4PDT	LY4-D	—	—	—
LED indicator and diode surge suppression	Plug-in/solder	SPDT	LY1N-D2	—	—	—
		DPDT	LY2N-D2	—	LY2ZN-D2	—
		4PDT	LY4N-D2	—	—	—
RC circuit	Plug-in/solder	SPDT	LY1-CR	—	—	—
		DPDT	LY2-CR	—	LY2Z-CR	—
LED indicator and RC circuit	Plug-in/solder	SPDT	LY1N-CR	—	—	—
		DPDT	LY2N-CR	—	LY2ZN-CR	—

- Note:**
1. Types with specifications other than those listed are available. Contact your Omron Sales representative.
  2. To order connecting sockets and mounting tracks, see "Accessories" section.
  3. Relays with RC circuit are only available in AC coil voltages of 100 VAC or greater.

Type	Terminal	Contact form	Model			
			Single contact		Bifurcated contact	
			Standard bracket mounting	Upper mounting bracket	Standard bracket mounting	Upper mounting bracket
Push-to-test button	Plug-in/solder	SPDT	LY114	—	—	—
		DPDT	LY214	—	LY2ZI2	—
		3PDT	LY314	—	—	—
		4PDT	LY414	—	—	—
LED indicator and push-to-test button	Plug-in/solder	DPDT	LY214N	—	LY2ZI2N	—
		4PDT	LY414N	—	—	—

**Note:** 1. Types with specifications other than those listed are available. Contact your Omron Sales representative.  
 2. To order connecting sockets and mounting tracks, see “Accessories” section.

## ■ Accessories

### Connecting Sockets

To Order: Select the appropriate part numbers for sockets, clips, and mounting tracks (if required) from the following charts.

#### Track Mounted Sockets

Relay	Socket*	Relay hold-down clip		Mounting track
		Standard	RC circuit	
SPDT DPDT	PTF08A-E	PYC-A1	Y92H-3	PFP-100N/PFP-50N & PFP-M or PFP-100N2 PFP-S (Option spacer)
3PDT	PTF11A			
4PDT	PTF14A-E			

\* Track mounted socket can be used as a front connecting socket.

#### Back Connecting Sockets

Relay	Solder terminal socket	Wire wrap terminal socket	Relay hold-down clip				Socket Mounting Plate			
			Standard	Push-to-test	RC circuit	Mtg. plate	1	10	12	18
SPDT DPDT	PT08	PT08QN	PYC-P	PYC-P2	PYC-1	PYC-S	PYP-1	—	—	PYP-18
3PDT	PT11	PT11QN					PTP-1-3	—	PTP-12	—
4PDT	PT14	PT14QN					PTP-1	PTP-10	—	—

**Note:** Types PYP-18, PTP-12 and PTP-10 may be cut to any desired length.

Relay	PC terminal socket	Relay hold-down clip		
		Standard	Push-to-test	RC circuit
SPDT DPDT	PT08-0	PYC-P	PYC-P2	PYC-1
3PDT	PT11-0			
4PDT	PT14-0			

# Specifications

## ■ Contact Data

Load	Single contact				Bifurcated contact	
	SPDT		DPDT, 3PDT, 4PDT		DPDT	
	Resistive load (p.f. = 1)	Inductive load (p.f. = 0.4) (L/R = 7 ms)	Resistive load (p.f. = 1)	Inductive load (p.f. = 0.4) (L/R = 7 ms)	Resistive load (p.f. = 1)	Inductive load (p.f. = 0.4) (L/R = 7 ms)
<b>Rated load</b>	15 A at 110 VAC 15 A at 24 VDC	10 A at 110 VAC 7 A at 24 VDC	10 A at 110 VAC 10 A at 24 VDC	7.5 A at 110 VAC 5 A at 24 VDC	5 A at 110 VAC 5 A at 24 VDC	4 A at 110 VAC 4 A at 24 VDC
<b>Contact material</b>	Ag-Alloy					
<b>Carry current</b>	15 A		10 A		7 A	
<b>Max. operating voltage</b>	250 VAC 125 VDC					
<b>Max. operating current</b>	15 A		10 A		7 A	
<b>Max. switching capacity</b>	1,700 VA 360 W	1,100 VA 170 W	1,100 VA 240 W	825 VA 120 W	550 VA 120 W	440 VA 100 W
<b>Min. permissible load</b>	100 mA, 5 VDC				10 mA, 5 VDC	

## ■ Coil Data

### 1- and 2-pole Types – AC

Rated voltage (V)	Rated current (mA)		Coil resistance (Ω)	Coil inductance (ref. value) (H)		Pick-up voltage	Dropout voltage	Maximum voltage	Power consumption (VA, W)
	50 Hz	60 Hz		Armature OFF	Armature ON				
6	214.10	183	12.20	0.04	0.08	80% max.	30% min.	110%	Approx. 1.00 to 1.20 (60 Hz)
12	106.50	91	46	0.17	0.33				
24	53.80	46	180	0.69	1.30				
50	25.70	22	788	3.22	5.66				
100/110	11.70/12.90	10/11	3,750	14.54	24.60				
110/120	9.90/10.80	8.40/9.20	4,430	19.20	32.10				
200/220	6.20/6.80	5.30/5.80	12,950	54.75	94.07				
220/240	4.80/5.30	4.20/4.60	18,790	83.50	136.40			Approx. 0.90 to 1.10 (60 Hz)	

### 1- and 2-pole Types – DC

Rated voltage (V)	Rated current (mA)	Coil resistance (Ω)	Coil inductance (ref. value) (H)		Pick-up voltage	Dropout voltage	Maximum voltage	Power consumption (VA, W)
			Armature OFF	Armature ON				
6	150	40	0.16	0.33	80% max.	10% min.	110%	Approx. 0.90
12	75	160	0.73	1.37				
24	36.90	650	3.20	5.72				
48	18.50	2,600	10.60	21				
100/110	9.10/10	11,000	45.60	86.20				

- Note:**
1. The rated current and coil resistance are measured at a coil temperature of 23°C (73°F) with tolerances of +15%, -20% for AC rated current, and ±15% for DC rated coil resistance.
  2. The AC coil resistance and inductance are reference values at 60 Hz.
  3. The performance characteristics are measured at a coil temperature of 23°C (73°F).
  4. Class B coil insulation is available.

### 3-pole Type – AC

Rated voltage (V)	Rated current (mA)		Coil resistance (Ω)	Coil inductance (ref. value) (H)		Pick-up voltage	Dropout voltage	Maximum voltage	Power consumption (VA, W)
	50 Hz	60 Hz		Armature OFF	Armature ON				
6	310	270	6.70	0.03	0.05	80% max.	30% min.	110%	Approx. 1.60 to 2.00 (60 Hz)
12	159	134	24	0.12	0.21				
24	80	67	100	0.44	0.79				
50	38	33	410	2.24	3.87				
100/110	15.90/18.30	13.60/15.60	2,300	10.50	18.50				
120	17.30	14.8	2,450	11.50	20.60				
200/220	10.50/11.60	9.00/9.90	8,650	34.80	59.50				
240	9.40	8	10,400	38.60	74.60				

### 3-pole Type – DC

Rated voltage (V)	Rated current (mA)	Coil resistance (Ω)	Coil inductance (ref. value) (H)		Pick-up voltage	Dropout voltage	Maximum voltage	Power consumption (VA, W)
			Armature OFF	Armature ON				
6	234	25.70	0.11	0.21	80% max.	10% min.	110%	Approx. 1.40
12	112	107	0.45	0.98				
24	58.60	410	1.89	3.87				
48	28.20	1,700	8.53	13.90				
100/110	12.70/13	8,500	29.60	54.30				

### 4-pole Type – AC

Rated voltage (V)	Rated current (mA)		Coil resistance (Ω)	Coil inductance (ref. value) (H)		Pick-up voltage	Dropout voltage	Maximum voltage	Power consumption (VA, W)
	50 Hz	60 Hz		Armature OFF	Armature ON				
6	386	330	5	0.02	0.04	80% max.	30% min.	110%	Approx. 1.95 to 2.50 (60 Hz)
12	199	170	20	0.10	0.17				
24	93.60	80	78	0.38	0.67				
50	46.80	40	350	1.74	2.88				
100/110	22.50/25.50	19/21.80	1,800	10.50	17.30				
120	19.00	16.40	2,200	9.30	19				
200/220	11.50/13.10	9.80/11.20	6,700	33.10	57.90				
240	11.00	9.50	9,000	33.20	63.40				

### 4-pole Type – DC

Rated voltage (V)	Rated current (mA)	Coil resistance (Ω)	Coil inductance (ref. value) (H)		Pick-up voltage	Dropout voltage	Maximum voltage	Power consumption (VA, W)
			Armature OFF	Armature ON				
6	240	25	0.09	0.21	80% max.	10% min.	110%	Approx. 1.50
12	120	100	0.39	0.84				
24	69	350	1.41	2.91				
48	30	1,600	6.39	13.60				
100/110	15/15.90	6,900	32	63.70				

- Note:**
1. The rated current and coil resistance are measured at a coil temperature of 23°C (73°F) with tolerances of +15%, -20% for AC rated current, and ±15% for DC rated coil resistance.
  2. The AC coil resistance and inductance are reference values at 60 Hz.
  3. The performance characteristics are measured at a coil temperature of 23°C (73°F).
  4. Class B coil insulation is available.

## ■ Characteristics

<b>Contact resistance</b>		50 mΩ max.
<b>Operate time</b>		25 ms max.
<b>Release time</b>		25 ms max.
<b>Operating frequency</b>	<b>Mechanically</b>	18,000 operations/hour
	<b>Under rated load</b>	1,800 operations/hour
<b>Insulation resistance</b>		100 MΩ min. (at 500 VDC)
<b>Dielectric strength</b>		2,000 VAC, 50/60 Hz for 1 minute 1,000 VAC, 50/60 Hz for 1 minute between contacts of same polarity
<b>Vibration</b>	<b>Mechanical durability</b>	10 to 55 Hz, 1.00 mm (0.04 in) double amplitude
	<b>Malfunction durability</b>	10 to 55 Hz, 1.00 mm (0.04 in) double amplitude
<b>Shock</b>	<b>Mechanical durability</b>	1,000 m/s <sup>2</sup> (approx. 100 G)
	<b>Malfunction durability</b>	200 m/s <sup>2</sup> (approx. 20 G)
<b>Ambient temperature</b>	<b>Operating</b>	LY1, LY2, LY3: -25° to 55°C; LY4 = -25° to 40°C
<b>Humidity</b>		35 to 85% RH
<b>Service Life</b>	<b>Mechanically</b>	AC: 50 million operations min. (at operating frequency of 18,000 operations/hour) DC: 100 million operations min. (at operating frequency of 18,000 operations/hour)
	<b>Electrically</b>	See "Characteristic Data"
<b>Weight</b>		SPDT, DPDT: Approx. 40 g (1.41 oz), 3PDT: Approx. 50 g (1.76 oz) 4PDT: Approx. 70 g (2.47 oz)

Note: Data shown are of initial value.

## ■ Characteristic Data

### Maximum switching capacity

LY1

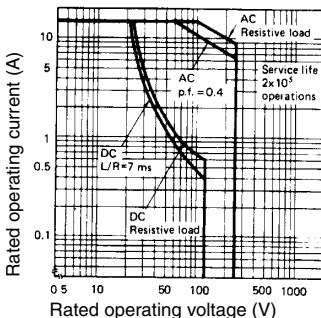

LY2

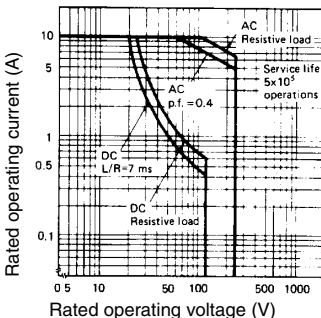

LY3, LY4

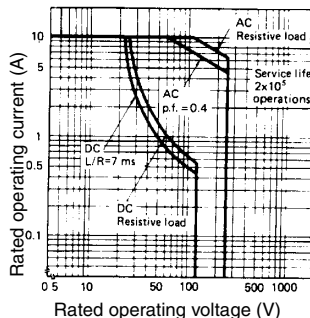

LY2Z

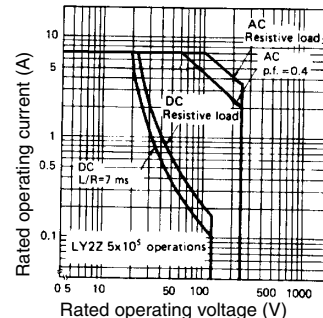

### Electrical service life

LY1

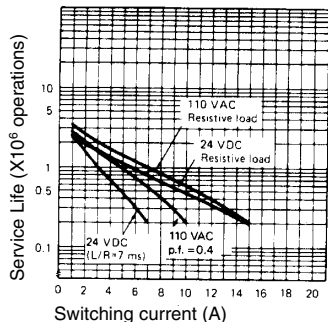

LY2

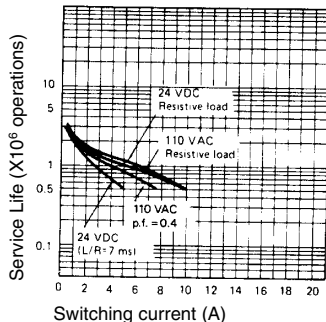

LY3, LY4

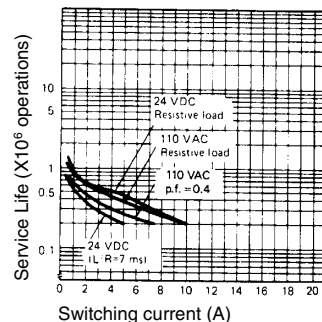

LY2Z

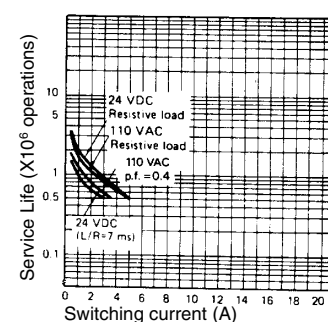

# Dimensions

Unit: mm (inch)

## Relays

LY1

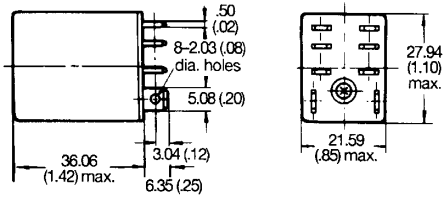

Terminal arrangement (Bottom view)

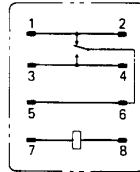

LY2

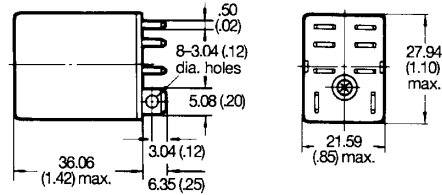

Terminal arrangement (Bottom view)

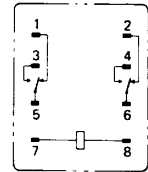

LY3

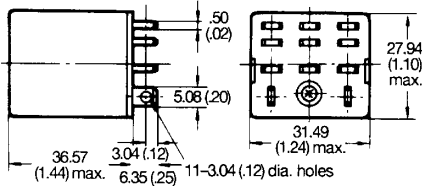

Terminal arrangement (Bottom view)

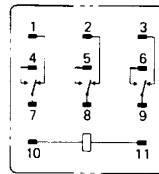

LY4

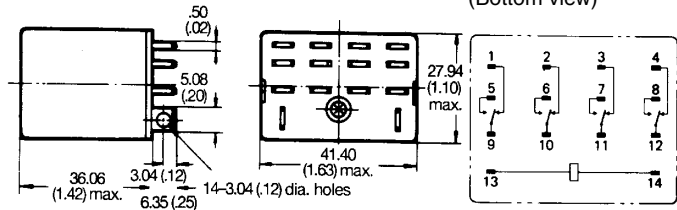

Terminal arrangement (Bottom view)

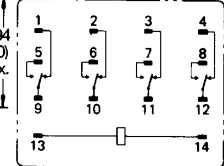

LY1-0, LY2-0, LY3-0, LY4-0

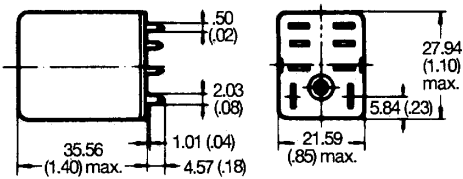

Mounting holes for LY1-0, LY2-0, LY3-0, LY4-0 (Bottom view)

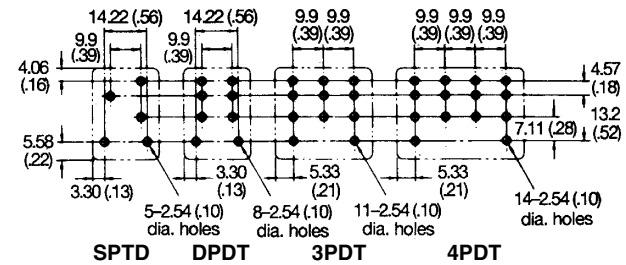

Note: The above drawing shows LY2-0. With LY1-0, dimension "\*" should read as eight 6.35 (.25).

LY1F, LY2F

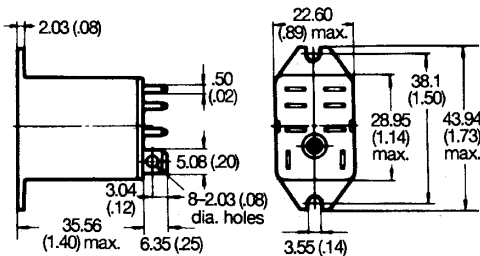

Mounting holes

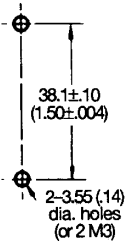

LY3F

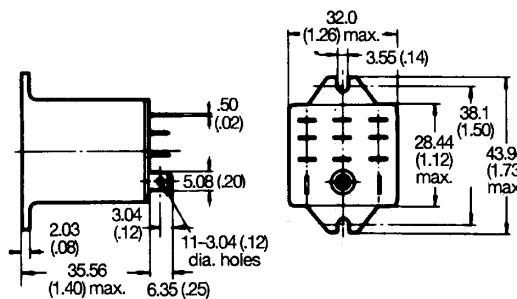

Mounting holes

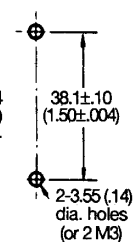

Note: The above drawing shows LY1F. With LY2F, dimension "\*" should read as eight 3.05 mm (0.12 in) dia. holes.

LY4F

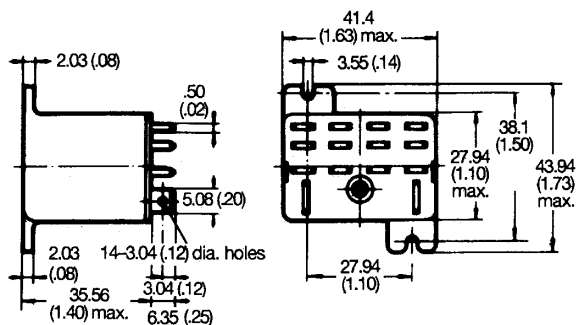

Mounting holes

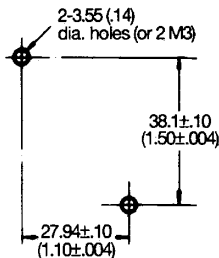

LY1S, LY2S

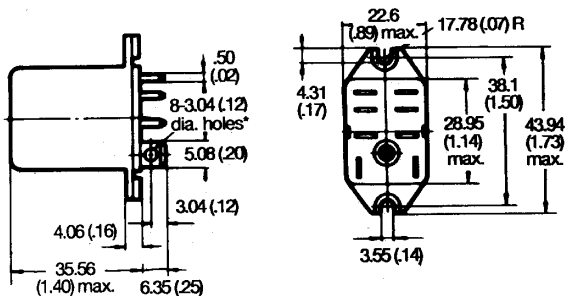

Round hole

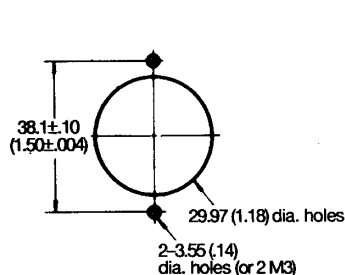

Rectangular hole

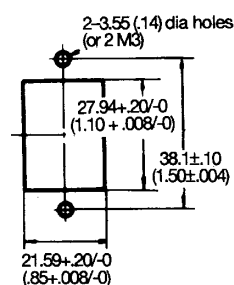

Note: The above drawing shows LY2S-US. With LY1S-US, dimension "\*\*\*\*" should read as eight 2.03 mm (0.08 in) dia. holes.

LY3S

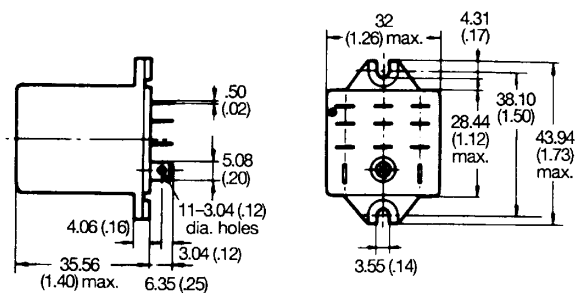

Round hole

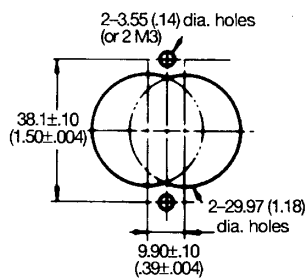

Rectangular hole

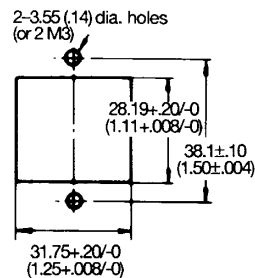

LY4S

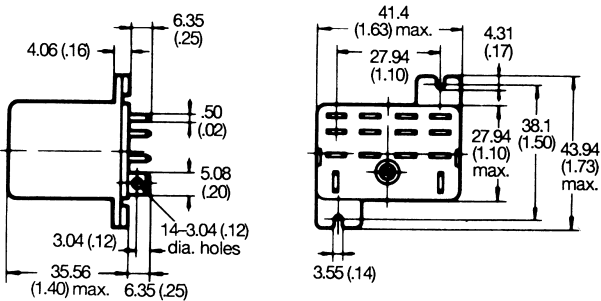

Round hole

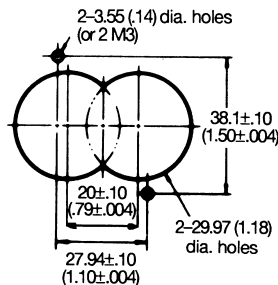

Rectangular hole

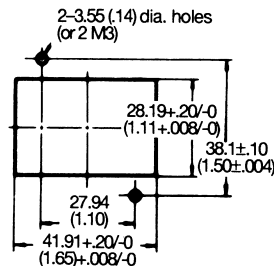

## Accessories

Unit: mm (inch)

### Track mounted sockets (UL File No. E87929) (CSA Report No. LR31928)

**PTF08A**  
(see note 3)

**Terminal arrangement/  
mounting holes**  
(Top view)

**PTF11A**

**Terminal arrangement/  
mounting holes**  
(Top view)

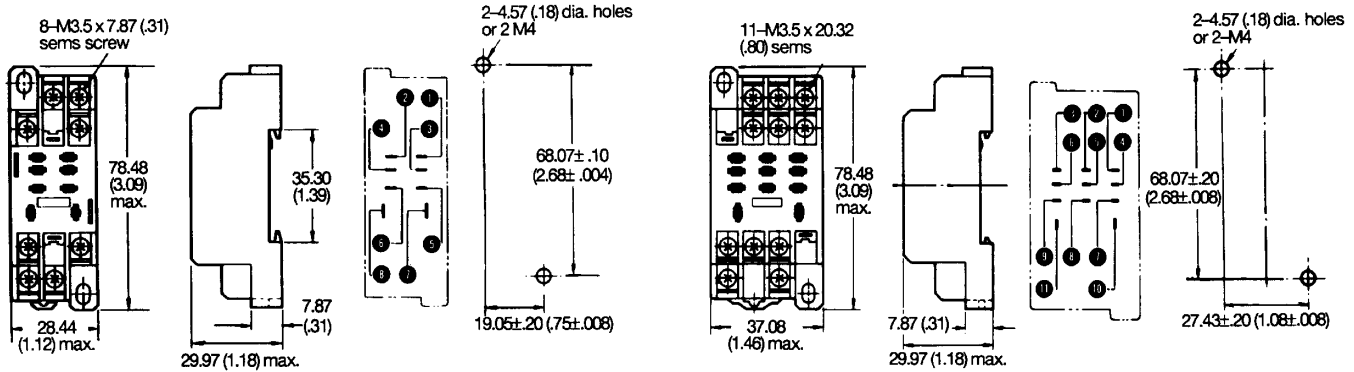

### Track mounting sockets (UL File No. E87929) (CSA Report No. LR31928)

**PTF14A**  
(see note 3)

**Terminal arrangement/  
mounting holes**  
(Top view)

**Mounting height of  
relay with socket**  
(Applies to all PTF□A sockets)

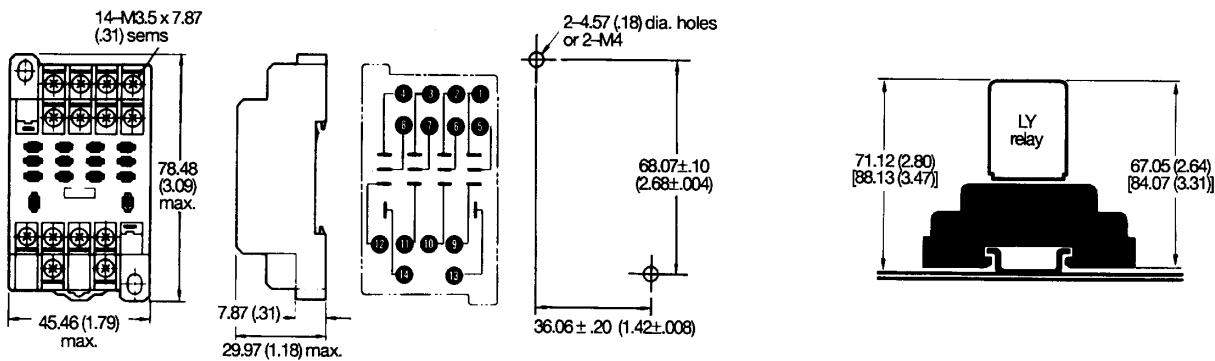

- Note:**
1. UL/CSA does not apply to wire wrap (Q) type sockets.
  2. Values in brackets for LY□CR.
  3. PTF08A-E and PTF14A-E = touch safe screws. Height = 33 mm max.

### Back connecting socket (UL File No. E87929) (CSA Report No. LR31928)

**PT08**

**Terminal arrangement/  
(Bottom view)**

**PT11**

**Terminal arrangement/  
(Bottom view)**

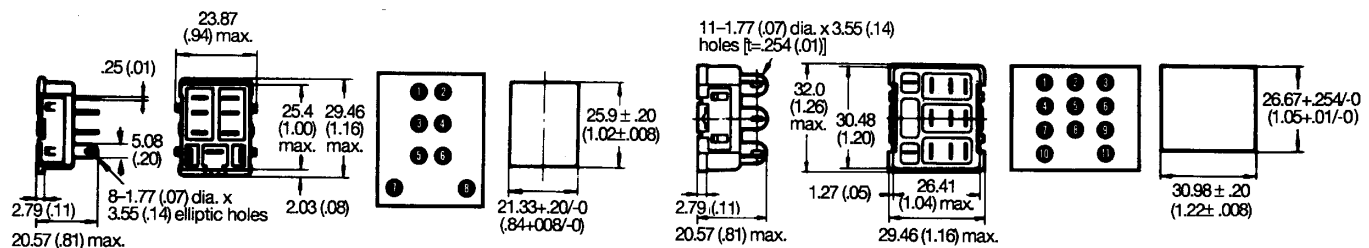



Back connecting socket (UL File No. E87929) (CSA Report No. LR31928)

PT14

Terminal arrangement  
(Bottom view)

Mounting height of relay with socket  
(Applies to all PT sockets)

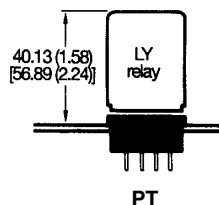
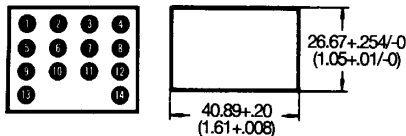
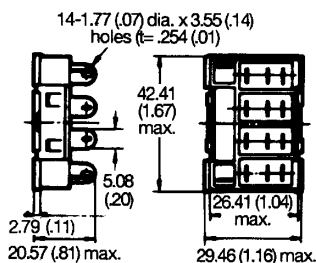

Note: Values in brackets for LY□CR.

Back connecting socket (UL File No. E87929) (CSA Report No. LR31928)

PT08QN

Panel cut-out and terminal arrangement are the same as Type PT08.

PT11QN

Panel cut-out and terminal arrangement are the same as Type PT11.

PT14QN

Panel cut-out and terminal arrangement are the same as Type PT14.

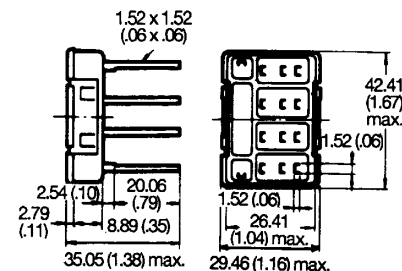
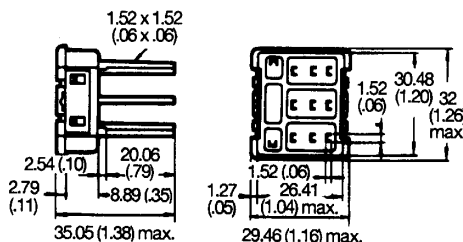
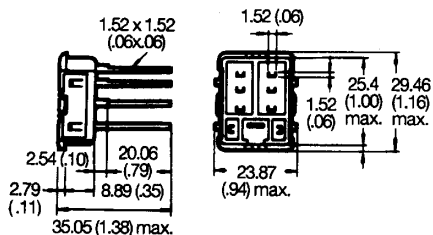

Back connecting socket (UL File No. E87929) (CSA Report No. LR31928)

PT08-0

Terminal arrangement is the same as Type PT08.

Mounting holes  
(Bottom view)

PT11-0

Terminal arrangement is the same as Type PT11.

Mounting holes  
(Bottom view)

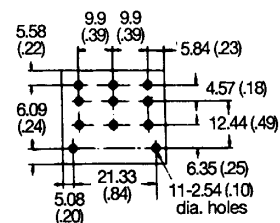
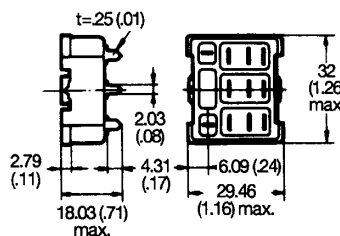
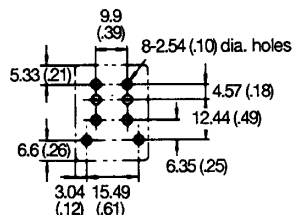
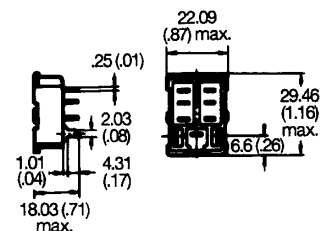

Back connecting socket (UL File No. E87929) (CSA Report No. LR31928)

PT14-0

Terminal arrangement is the same as Type PT14.

Mounting holes  
(Bottom view)

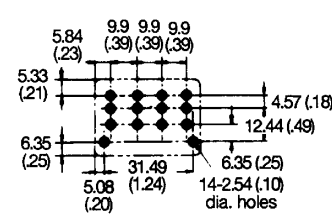
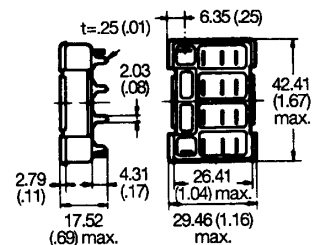

Unit: mm (inch)

**Relay hold-down clips**

**PYC-A1**

For PTF□A socket

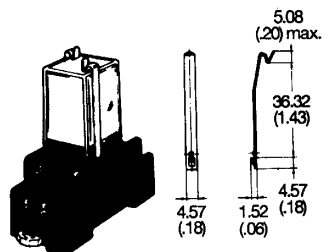

**PYC-S**

For relay mounting plates  
(Applicable to Type PYP-1 and PYP-18 socket mounting plates only.)

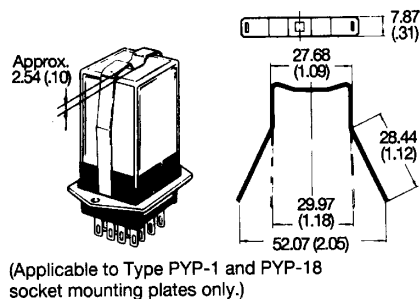

**PYC-P**

For PT□ socket

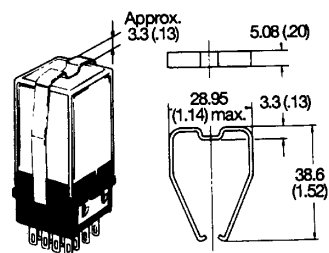

**Relay hold-down clips**

**PYC-P2**

For push-to-test button type with PT□ socket

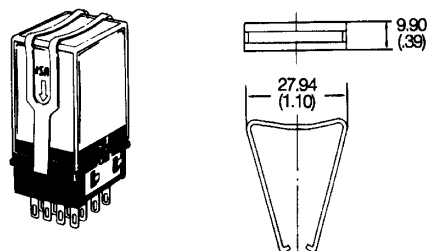

**Y92H-3**

For RC circuit type

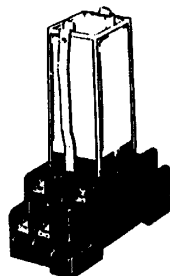

**PYC-1**

For RC circuit type



**Mounting track/end plate/spacer**

**PFP-100N, PFP-50N**  
(Conforming to EN 50022)

**PFP-100N2**  
(Conforming to EN 50022)

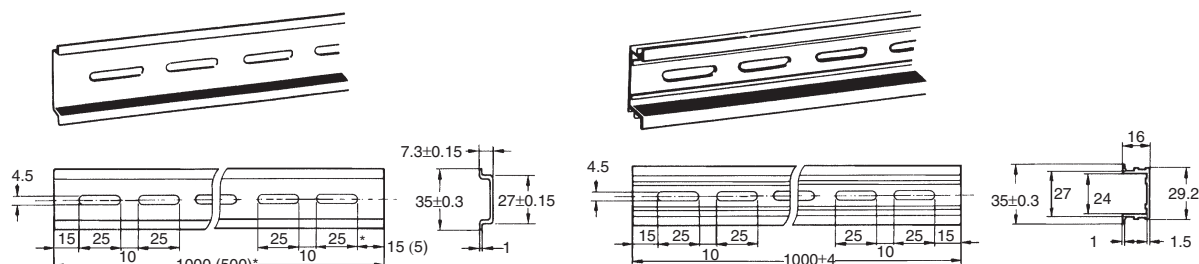

\* The figure in parenthesis is for PFP-50N.

\*This dimension is 14.99 mm (0.59 in) on both ends in the case of PFP-100N, but on one end in the case of PFP-50N.

\*\* L = Length

PFP-50N L = 497.84 mm (19.60 in)

PFP-100N L = 990.60 mm (39.00 in)

PFP-100N2 L = 990.60 mm (39.00 in)

\*\*\*A total of twelve 24.89 x 4.57 mm (0.98 x 0.18 in) elliptic holes are provided, with six holes cut from each end of the track at a pitch of 9.91 (0.39) between holes.

PFP-M end plate

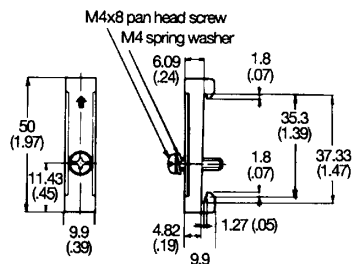

PFP-S spacer

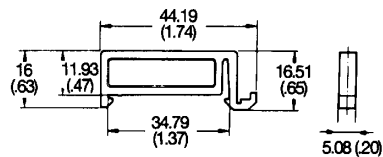

Socket mounting plates [t=1.52 (.06)]

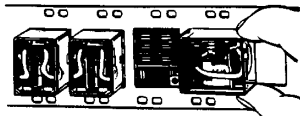

Socket needed	Number of socket specs.			
	1	10	12	18
PT08, PT08QN	PYP-1	-	-	PYP-18
PT11, PT11QN	PTP-1-3	-	PTP-1-2	-
PT14, PT14QN	PTP-1	PTP-10	-	-
PTP-10	PTP-12			

PYP-1

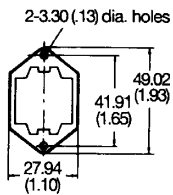

PTP-1-3

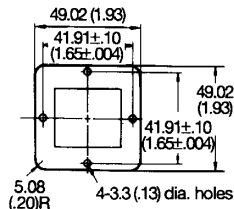

PTP-1

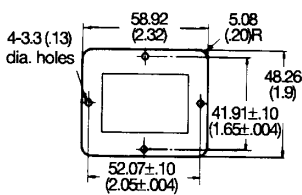

PYP-18

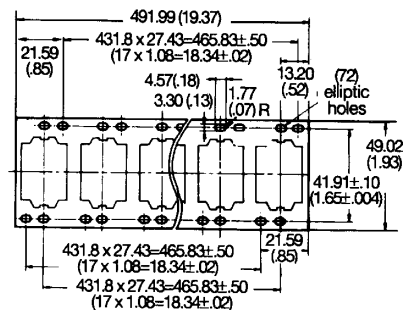

PTP-10

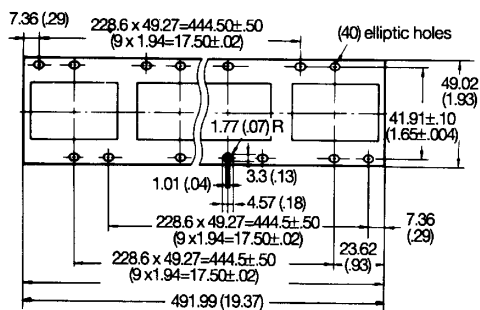

PTP-12

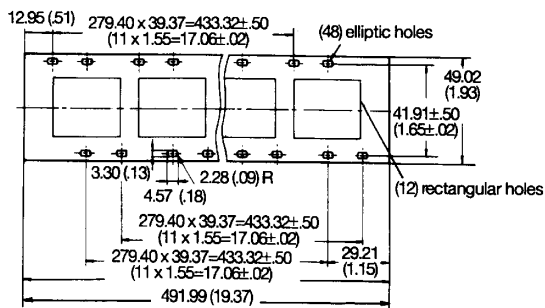

## Relay Options

### LED Indicator

Specifications and dimensions same as the Standard Type with the following exception. With the LED indicator type, the rated current is approximately 0 to 5.0 mA higher than the Standard Type.

#### Terminal arrangement/Internal connections (Bottom view)

##### LY2N

##### DC coil rating type

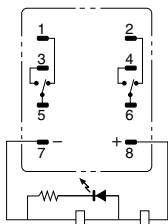

##### AC coil rating type

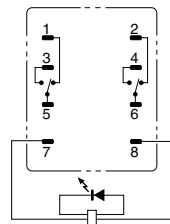

- Note:**
1. The coil terminals 10 and 11 of Type LY3N become (-) and (+) and terminals 13 and 14 of Type LY4N become (-) and (+), respectively.
  2. Pay special attention to the polarities when using the DC type.

### Diode Surge Suppression

Specifications and dimensions same as the Standard Type with the following exception. Ambient operating temperature: -25° to 40°C (-13° to 104°F)

#### Without Diode

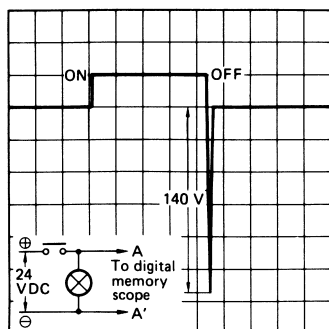

#### With Diode

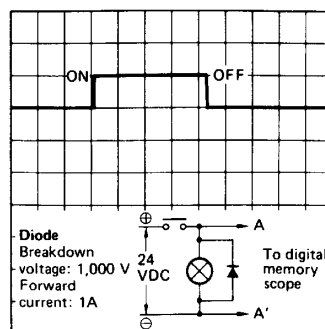

#### Terminal arrangement/Internal connections (Bottom view)

##### LY2(N)-D(2)

**LY2-D**  
6, 12, 24, 48  
100/110 VDC

**LY2N-D2**  
6, 12, 24, 48 VDC

**LY2N-D2**  
100/110 VDC

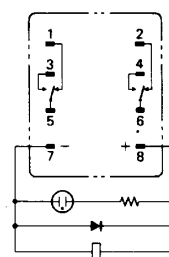
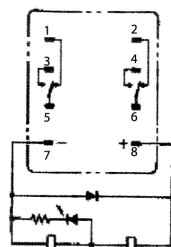
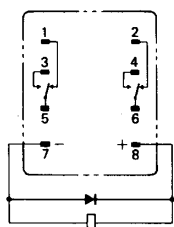

- Note:**
1. Pay special attention to the polarities when using the DC type.
  2. The release time is somewhat longer, but satisfies the standard specifications of 25 ms.
  3. The reverse-breakdown voltage of the diode is 1,000 VDC.
  4. Available on DC versions only.

## Relay Options

### RC Circuit

Specifications and dimensions same as the Standard Type with the following exceptions.

#### Characteristic Data

##### Without RC circuit

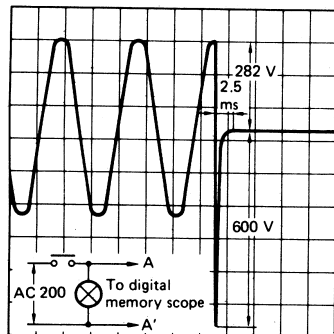

##### With RC circuit

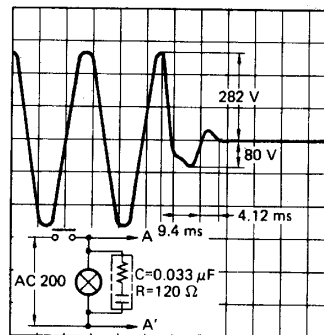

#### LY1-CR, LY2(Z)-CR

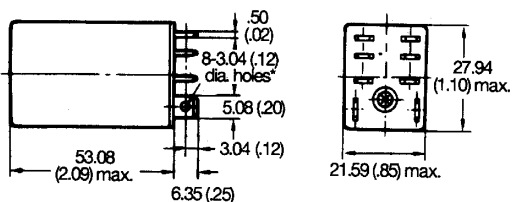

#### Terminal arrangement/Internal connections (Bottom view)

##### LY1-CR

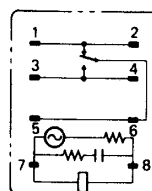

##### LY2(Z)-CR

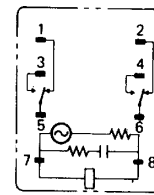

RC circuit  
C: 0.033  $\mu$ F  
R: 120  $\Omega$

- Note:**
- The above drawing shows LY2(Z)-CR. With LY1-CR, “\*” should read eight 2.03 mm (0.08 in) dia. holes.
  - Available on AC versions only.

#### Push-to-test Button

Specifications and dimensions same as the Standard Type with the following exceptions.

##### LY□12

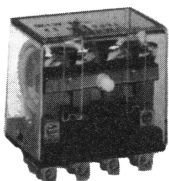

##### LY112, LY212

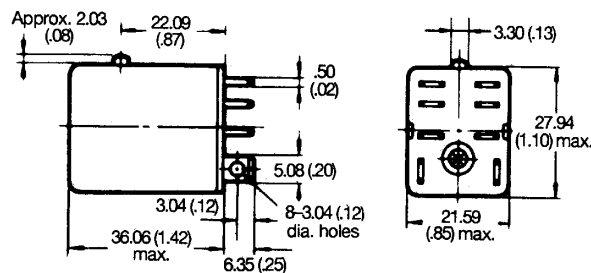

**Note:** Type LY112 has the same dimensions and appearances as Type LY212 shown except that dimensions “\*” is 2.03 mm (0.08 in) dia. holes.

##### LY312

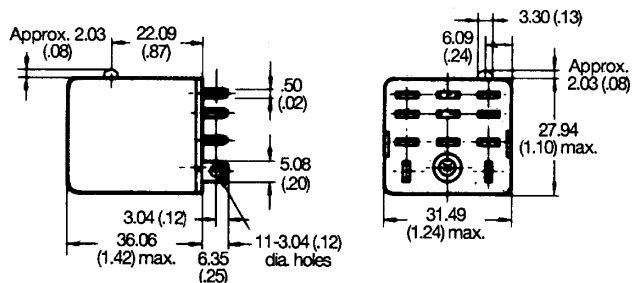

##### LY412

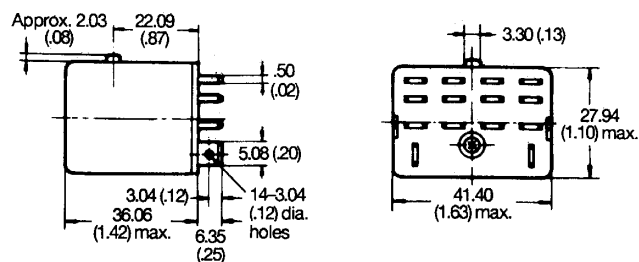

## ■ Approvals

### UL Recognized Type (File No. E41643)

Type	Contact form	Coil ratings	Contact ratings	Number of test operations
LY1□	SPDT	6 to 240 VAC 6 to 120 VDC	15A, 30VDC (Resistive), 40°C	6 x 10 <sup>3</sup>
			15A, 240VAC (General use), 40°C	
			TV-5, 120VAC, 40°C	25 x 10 <sup>3</sup>
			1/2HP, 120VAC, 50°C	
LY2□	DPDT		15A, 28VDC (Resistive), 40°C	6 x 10 <sup>3</sup>
			15A, 120VAC (Resistive), 40°C	
			12A, 240VAC (General use), 40°C	25 x 10 <sup>3</sup>
			1/2HP, 120VAC, 50°C	
	TV-3, 120VAC, 40°C			
LY3□	3PDT		10A, 30VDC (Resistive), 40°C (Same polarity )	6 x 10 <sup>3</sup>
LY4□	4PDT		10A, 240VAC (General use), 40°C (Same polarity )	
			1/2HP, 240VAC, 40°C	
LY2Z□ (Bifurcated)	DPDT		7A, 240VAC (General use), 40°C	6 x 10 <sup>3</sup>
			7A, 28VDC (Resistive), 40°C	

### CSA Certified Type (File No. LR31928)

Type	Contact form	Coil ratings	Contact ratings
LY1□	SPDT	6 to 240 VAC 6 to 120 VDC	15 A, 120 VAC (Inductive)
			10 A, 240 VAC (Inductive)
			15 A, 28 VDC (Resistive)
			TV-5 (ACTV)
LY2□	DPDT		13 A, 28 VDC (Resistive)
			12 A, 120 VAC (Inductive)
			10 A, 240 VAC (Inductive)
			1/3 HP, 120 VAC (Motor)
			TV-3 (ACTV)
LY3□	3PDT		10 A, 240 VAC (Inductive)
LY3□	4PDT		10 A, 28 VDC (Resistive)

### VDE Approved Type (File No. 9903 [SPDT, DPDT & 3PDT], File No. 9947 [4PDT])

Type	Contact form	Coil ratings	Contact ratings
LY□-VD	SPDT	6, 12, 24, 50, 110, 220 VAC and 6, 12, 24, 48, 110 VDC	10 A, 220 VAC (Resistive)
			10 A, 28 VDC (Resistive)
			7 A, 220 VAC (Inductive)
			7 A, 28 VDC (Inductive)
LY□-VD	DPDT		7 A, 220 VAC (Resistive)
	3PDT		7 A, 28 VDC (Resistive)
	4PDT		4 A, 28 VDC and 4A, 220 VAC (Inductive)

### LR (Lloyd's Register) Approved Type (File No. 562KOB-204523)

Type	Contact form	Coil ratings	Contact ratings
LY□	DPDT	6 to 240 VAC	7.5 A, 230 VAC (Inductive)
	4PDT	6 to 110 VDC	5 A, 24 VDC (Inductive)

### SEV Listed Type (File No. D7 91/82 [2- & 4-pole], D 91/204a [1- & 3-pole])

Type	Contact form	Coil ratings	Contact ratings
LY□-SV	SPDT	6 to 240 VAC 6 to 110 VDC	15 A, 220 VAC (Resistive)
			15 A, 24 VDC (Resistive)
LY□-SV	DPDT		10 A, 220 VAC (Resistive)
	3PDT		10 A, 24 VDC (Resistive)
	4PDT		

**Note:** 1. The rated values approved by each of the safety standards (e.g., UL, CSA, VDE, and SEV) may be different from the performance characteristics individually defined in this catalog.

2. In the interest of product improvement, specifications are subject to change.



All sales are subject to Omron Electronic Components LLC standard terms and conditions of sale, which can be found at [http://www.components.omron.com/components/web/webfiles.nsf/sales\\_terms.html](http://www.components.omron.com/components/web/webfiles.nsf/sales_terms.html)

**ALL DIMENSIONS SHOWN ARE IN MILLIMETERS.**

To convert millimeters into inches, multiply by 0.03937. To convert grams into ounces, multiply by 0.03527.

---

**OMRON**<sup>®</sup>

**OMRON ELECTRONIC  
COMPONENTS LLC**

55 E. Commerce Drive, Suite B  
Schaumburg, IL 60173

**847-882-2288**

**OMRON ON-LINE**

Global - <http://www.omron.com>

USA - <http://www.components.omron.com>

Cat. No. X301-E-1b

09/11

Specifications subject to change without notice

Printed in USA





Компания «ЭлектроПласт» предлагает заключение долгосрочных отношений при поставках импортных электронных компонентов на взаимовыгодных условиях!

Наши преимущества:

- Оперативные поставки широкого спектра электронных компонентов отечественного и импортного производства напрямую от производителей и с крупнейших мировых складов;
- Поставка более 17-ти миллионов наименований электронных компонентов;
- Поставка сложных, дефицитных, либо снятых с производства позиций;
- Оперативные сроки поставки под заказ (от 5 рабочих дней);
- Экспресс доставка в любую точку России;
- Техническая поддержка проекта, помощь в подборе аналогов, поставка прототипов;
- Система менеджмента качества сертифицирована по Международному стандарту ISO 9001;
- Лицензия ФСБ на осуществление работ с использованием сведений, составляющих государственную тайну;
- Поставка специализированных компонентов (Xilinx, Altera, Analog Devices, Intersil, Interpoint, Microsemi, Aeroflex, Peregrine, Syfer, Eurofarad, Texas Instrument, Miteq, Cobham, E2V, MA-COM, Hittite, Mini-Circuits, General Dynamics и др.);

Помимо этого, одним из направлений компании «ЭлектроПласт» является направление «Источники питания». Мы предлагаем Вам помощь Конструкторского отдела:

- Подбор оптимального решения, техническое обоснование при выборе компонента;
- Подбор аналогов;
- Консультации по применению компонента;
- Поставка образцов и прототипов;
- Техническая поддержка проекта;
- Защита от снятия компонента с производства.



#### Как с нами связаться

**Телефон:** 8 (812) 309 58 32 (многоканальный)

**Факс:** 8 (812) 320-02-42

**Электронная почта:** [org@eplast1.ru](mailto:org@eplast1.ru)

**Адрес:** 198099, г. Санкт-Петербург, ул. Калинина, дом 2, корпус 4, литера А.