

General Specifications

Electrical Capacity (Resistive Load)

Logic Level: 0.4VA maximum @ 28V AC/DC maximum
(Applicable Range 0.1mA ~ 0.1A @ 20mV ~ 28V)
Note: Find additional explanation of operating range in Supplement section.

Other Ratings

Contact Resistance: 50 milliohms maximum

Insulation Resistance: 500 megohms minimum @ 500V DC

Dielectric Strength: 500V AC minimum for 1 minute minimum

Mechanical Life: 50,000 operations minimum (momentary)

25,000 operations minimum (alternate action)

Electrical Life: 50,000 operations minimum (momentary)

25,000 operations minimum (alternate action)

Nominal Operating Force: 2.55N (momentary); 2.94N (alternate action)

Contact Timing: Nonshorting

Travel: Momentary: Pretravel .028" (0.7mm); Overtravel .016" (0.4mm); Total Travel .043" (1.1mm)
Alternate: Pretravel .039" (1.0mm); Overtravel .039" (1.0mm); Total Travel .079" (2.0mm)

Materials & Finishes

Plunger: Polyacetal

Bushing: Carbon blended polyamide

Case Housing: Glass fiber reinforced polyamide

Support Bracket: Tin plated phosphor bronze

Movable Contact: Phosphor bronze with gold plating

Stationary Contacts: Copper alloy with gold plating

Terminals: Copper alloy with gold plating

Environmental Data

Operating Temp Range: -30°C through +85°C (-22°F through +185°F)

Humidity: 90 ~ 95% humidity for 96 hours @ 40°C (104°F)

Vibration: 10 ~ 55Hz with peak-to-peak amplitude of 1.5mm traversing the frequency range & returning in 1 minute; 3 right angled directions for 2 hours

Shock: 50G (490m/s²) acceleration (tested in 6 right angled directions, with 5 shocks in each direction)

Installation

Cap Installation Force: 49.03N (11.2 lbf) maximum downward force on actuator;
actuator must be in UP position to remove cap from alternate action models

PCB Processing

Soldering: Wave Soldering Recommended: See Profile A in Supplement section.

Manual Soldering: See Profile B in Supplement section.

Cleaning: Automated cleaning. See Cleaning specifications in Supplement section.

Standards & Certifications

Flammability Standards: UL94V-0 available

The BB Series pushbuttons have not been tested for UL recognition or CSA certification.

These switches are designed for use in a low-voltage, low-current, logic-level circuit.

When used as intended in a logic-level circuit, the results do not produce hazardous energy.

Distinctive Characteristics

Subminiature size (1/3 size of Series M switches) saves space on PC boards.

Specifically developed for logic-level applications.

Available in momentary and maintained circuits.

Industry's smallest alternate action (maintained) pushbutton with latchdown feature providing visible, audible, and tactile feedback.

Antistatic superstructure, consisting of the carbon impregnated bushing and the support bracket, prevents static discharge to the contacts. Static electricity from an operator's touch travels from the actuator through the bushing and bracket to the PC board.

Award-winning STC contact mechanism with benefits unavailable in conventional mechanisms: smoother, positive detent actuation, increased contact stability and unparalleled logic-level reliability. (Additional STC details in Terms & Acronyms; see Supplement section.)

Smooth, 6mm diameter bushing simplifies panel layout.

Totally sealed body construction prevents contact contamination and allows time- and money-saving soldering and cleaning.

.100" x .100" (2.54mm x 2.54mm) terminal spacing conforms to standard PC board grids.

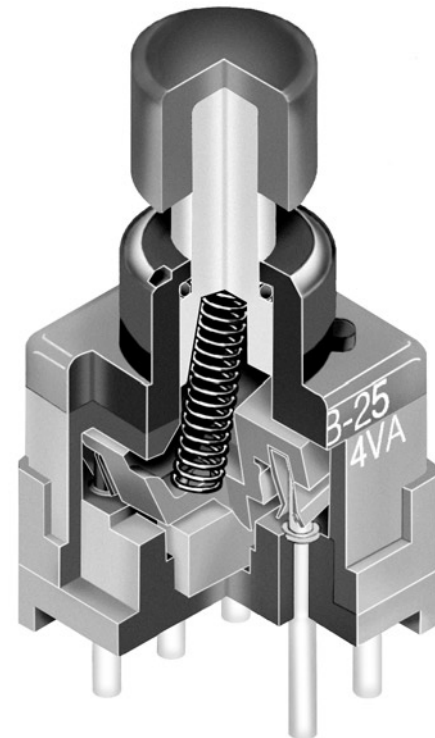

Actual Size

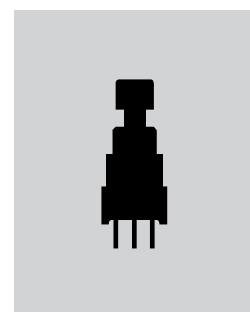

- Supplement
- Accessories
- Indicators
- Touch
- Tilt
- Tactiles
- Slides
- Rotaries
- Keylocks
- Programmable
- Illuminated PB
- Pushbuttons
- Rockers
- Toggles

TYPICAL SWITCH ORDERING EXAMPLE

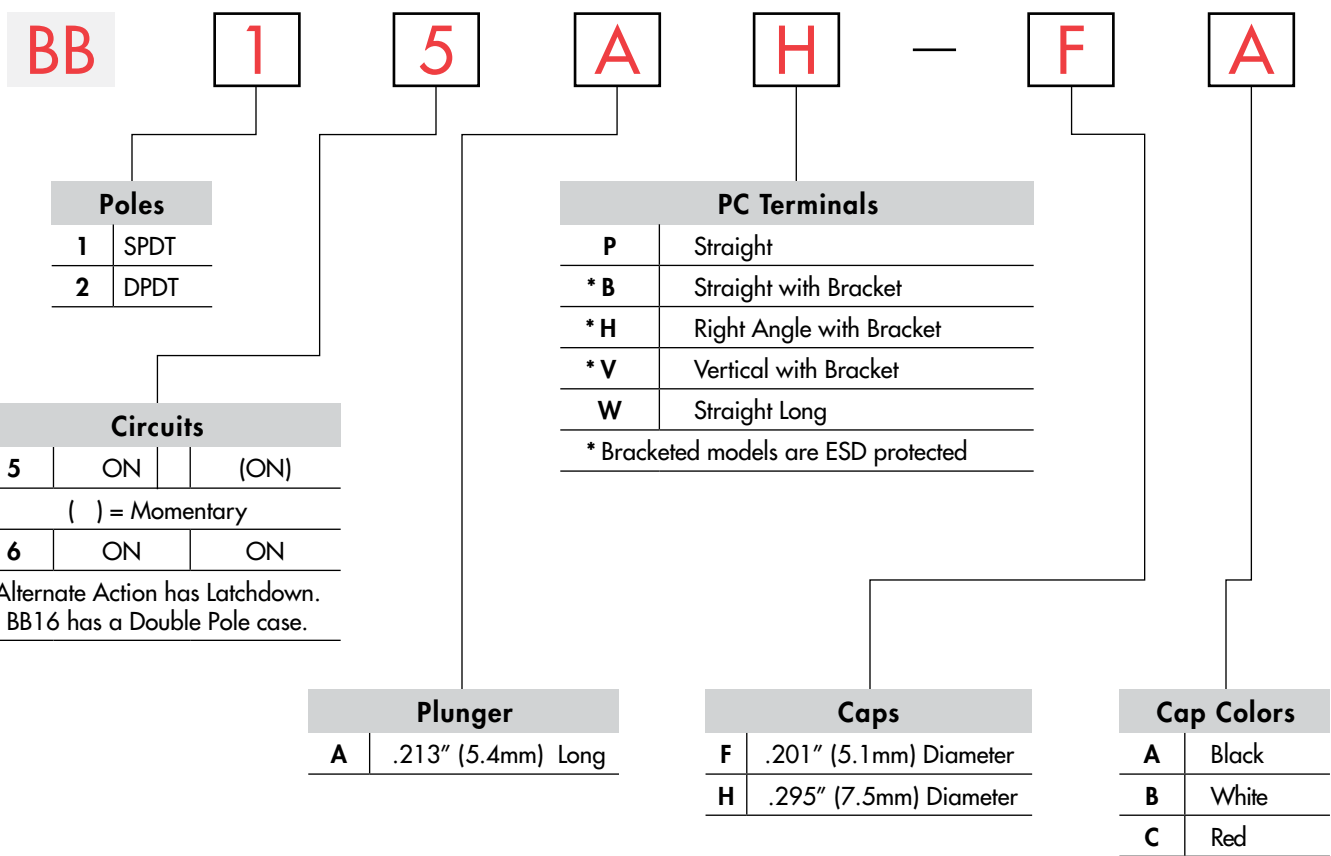

DESCRIPTION FOR TYPICAL ORDERING EXAMPLE

BB15AH-FA

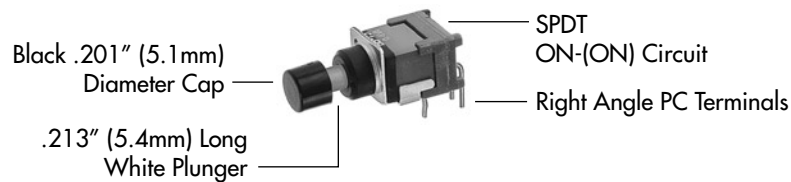

Toggles
 Rockers
 Pushbuttons
 Illuminated PB
 Programmable
 Keylocks
 Rotaries
 Slides
 Tactiles
 Tilt
 Touch
 Indicators
 Accessories
 Supplement

POLES & CIRCUITS

Pole	Model	Plunger Position () = Momentary		Connected Terminals		Throw & Schematics
		Normal	Down	Normal	Down	
SP	BB15 BB16	ON ON	(ON) ON	2-3	2-1	SPDT
DP	BB25 BB26	ON ON	(ON) ON	2-3 5-6	2-1 5-4	DPDT

PLUNGERS

A .213" (5.4mm) Long

Standard Plunger Color: White

Contact factory for other colors and lengths.

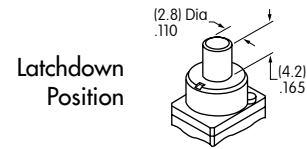
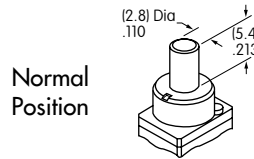

PC TERMINALS

Use of a support bracket is recommended to increase PCB mounting strength and stability.

Both single pole and double pole alternate action models have double pole bases.

See Typical Switch Dimensions for details.

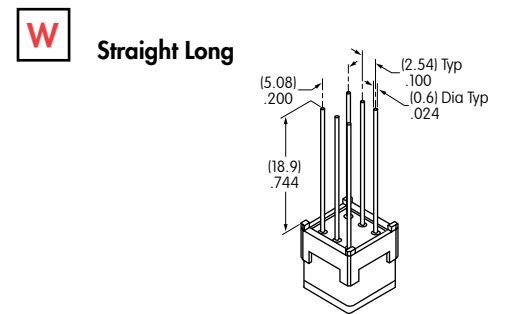
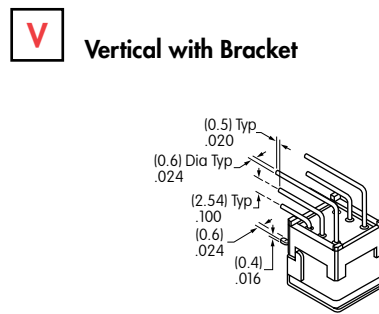
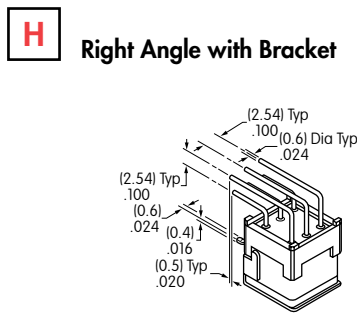
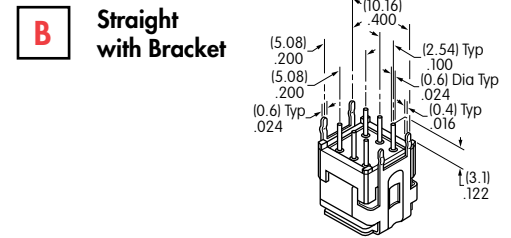
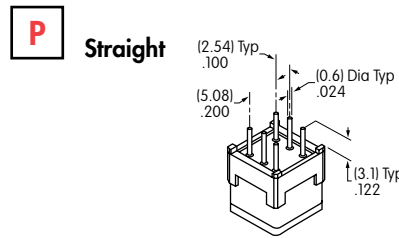

SLIP-ON CAPS

F AT475
.201" (5.1mm) Diameter Cap



Material: Polyamide

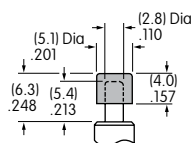

H AT496
.295" (7.5mm) Diameter Cap



Material: Polyamide

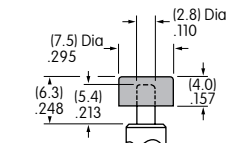

Colors Available:

A Black

B White

C Red

TYPICAL SWITCH DIMENSIONS

Straight PC

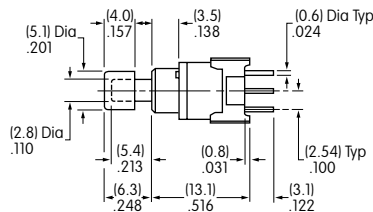
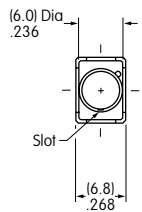

Single Pole

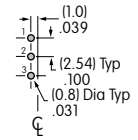
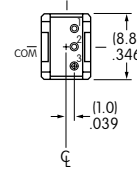

BB15AP-FA

Momentary

Straight PC

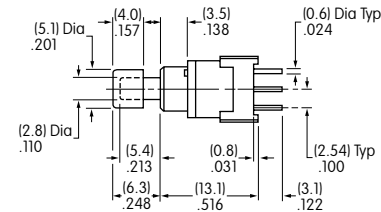
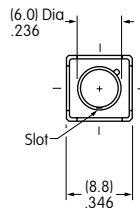

Double Pole

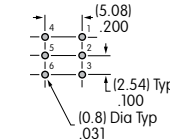
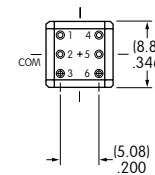

BB16AP

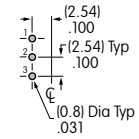
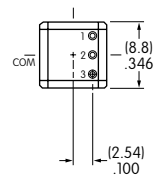

BB25AP-FA

Momentary & Alternate

Alternate

Straight PC • Bracket

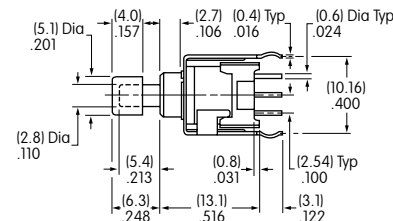
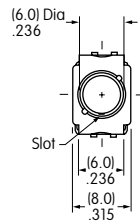

Single Pole

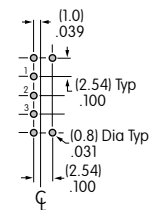
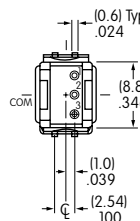

BB15AB-FA

Momentary

Straight PC • Bracket

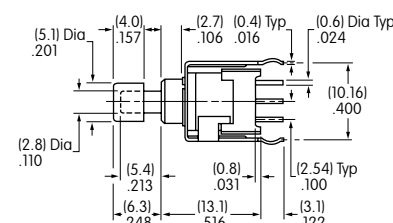
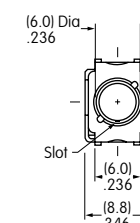

Double Pole

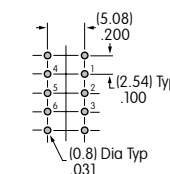
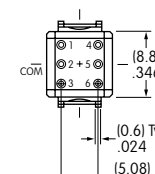

BB16AB

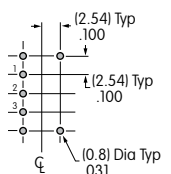
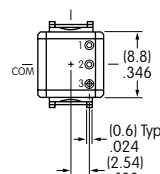

BB25AB-FA

Momentary & Alternate

Alternate

Toggles
Rockers
Pushbuttons
Illuminated PB
Programmable
Keylocks
Rotaries
Slides
Tactiles
Tilt
Touch
Indicators
Accessories
Supplement

TYPICAL SWITCH DIMENSIONS

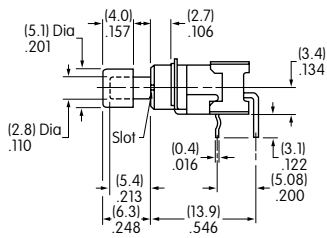
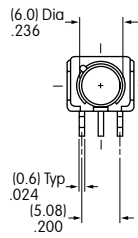

Single Pole

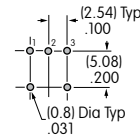
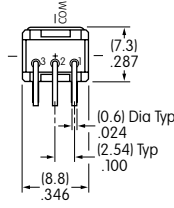

Momentary

Right Angle PC



BB15AH-FA

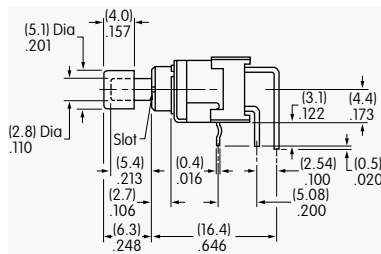
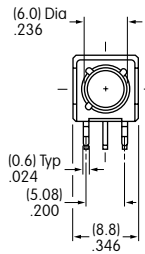

Double Pole

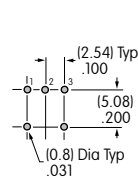
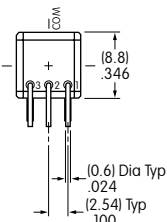
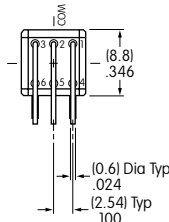

Momentary & Alternate

Alternate

Right Angle PC



BB25AH-FA

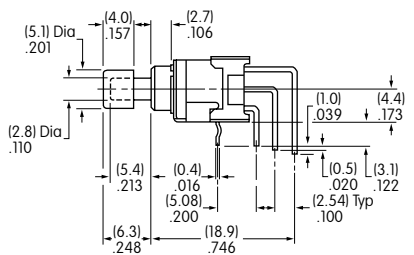
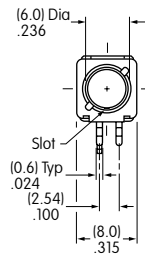

Single Pole

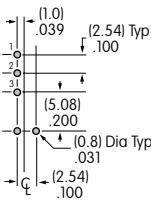
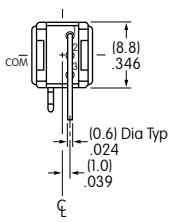

Momentary

Vertical PC



BB15AV-FA

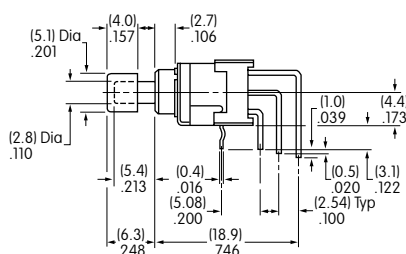
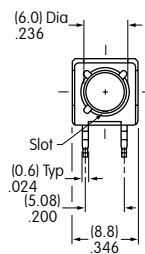

Double Pole

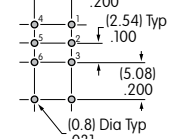
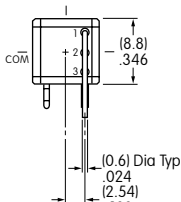
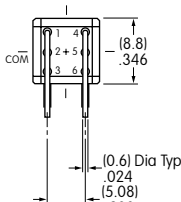

Momentary & Alternate

Alternate

Vertical PC



BB25AV-FA



Компания «ЭлектроПласт» предлагает заключение долгосрочных отношений при поставках импортных электронных компонентов на взаимовыгодных условиях!

Наши преимущества:

- Оперативные поставки широкого спектра электронных компонентов отечественного и импортного производства напрямую от производителей и с крупнейших мировых складов;
- Поставка более 17-ти миллионов наименований электронных компонентов;
- Поставка сложных, дефицитных, либо снятых с производства позиций;
- Оперативные сроки поставки под заказ (от 5 рабочих дней);
- Экспресс доставка в любую точку России;
- Техническая поддержка проекта, помощь в подборе аналогов, поставка прототипов;
- Система менеджмента качества сертифицирована по Международному стандарту ISO 9001;
- Лицензия ФСБ на осуществление работ с использованием сведений, составляющих государственную тайну;
- Поставка специализированных компонентов (Xilinx, Altera, Analog Devices, Intersil, Interpoint, Microsemi, Aeroflex, Peregrine, Syfer, Eurofarad, Texas Instrument, Miteq, Cobham, E2V, MA-COM, Hittite, Mini-Circuits, General Dynamics и др.);

Помимо этого, одним из направлений компании «ЭлектроПласт» является направление «Источники питания». Мы предлагаем Вам помощь Конструкторского отдела:

- Подбор оптимального решения, техническое обоснование при выборе компонента;
- Подбор аналогов;
- Консультации по применению компонента;
- Поставка образцов и прототипов;
- Техническая поддержка проекта;
- Защита от снятия компонента с производства.



Как с нами связаться

Телефон: 8 (812) 309 58 32 (многоканальный)

Факс: 8 (812) 320-02-42

Электронная почта: org@eplast1.ru

Адрес: 198099, г. Санкт-Петербург, ул. Калинина, дом 2, корпус 4, литера А.