

# General Specifications

## Electrical Capacity (Resistive Load)

**Logic Level:** 0.4VA maximum @ 28V AC/DC maximum  
(Applicable Range 0.1mA ~ 0.1A @ 20mV ~ 28V)  
Note: Find additional explanation of operating range in Supplement section.

## Other Ratings

**Contact Resistance:** 50 milliohms maximum  
**Insulation Resistance:** 500 megohms minimum @ 500V DC  
**Dielectric Strength:** 500V AC minimum for 1 minute minimum  
**Mechanical Life:** 50,000 operations minimum (momentary)  
 25,000 operations minimum (alternate action)  
**Electrical Life:** 50,000 operations minimum (momentary)  
 25,000 operations minimum (alternate action)  
**Nominal Operating Force:** 2.55N (momentary); 2.94N (alternate action)  
**Contact Timing:** Nonshorting  
**Travel:** Momentary: Pretravel .028" (0.7mm); Overtravel .016" (0.4mm); Total Travel .043" (1.1mm)  
 Alternate: Pretravel .039" (1.0mm); Overtravel .039" (1.0mm); Total Travel .079" (2.0mm)

## Materials & Finishes

**Plunger:** Polyacetal  
**Bushing:** Carbon blended polyamide  
**Case Housing:** Glass fiber reinforced polyamide  
**Support Bracket:** Tin plated phosphor bronze  
**Movable Contact:** Phosphor bronze with gold plating  
**Stationary Contacts:** Copper alloy with gold plating  
**Terminals:** Copper alloy with gold plating

## Environmental Data

**Operating Temp Range:** -30°C through +85°C (-22°F through +185°F)  
**Humidity:** 90 ~ 95% humidity for 96 hours @ 40°C (104°F)  
**Vibration:** 10 ~ 55Hz with peak-to-peak amplitude of 1.5mm traversing the frequency range & returning in 1 minute; 3 right angled directions for 2 hours  
**Shock:** 50G (490m/s<sup>2</sup>) acceleration (tested in 6 right angled directions, with 5 shocks in each direction)

## Installation

**Cap Installation Force:** 49.03N (11.2 lbf) maximum downward force on actuator;  
actuator must be in UP position to remove cap from alternate action models

## PCB Processing

**Soldering:** Wave Soldering Recommended: See Profile A in Supplement section.  
Manual Soldering: See Profile B in Supplement section.  
**Cleaning:** Automated cleaning. See Cleaning specifications in Supplement section.

## Standards & Certifications

**Flammability Standards:** UL94V-0 available  
The BB Series pushbuttons have not been tested for UL recognition or CSA certification.  
These switches are designed for use in a low-voltage, low-current, logic-level circuit.  
When used as intended in a logic-level circuit, the results do not produce hazardous energy.

# Distinctive Characteristics

Subminiature size (1/3 size of Series M switches) saves space on PC boards.

Specifically developed for logic-level applications.

Available in momentary and maintained circuits.

Industry's smallest alternate action (maintained) pushbutton with latchdown feature providing visible, audible, and tactile feedback.

Antistatic superstructure, consisting of the carbon impregnated bushing and the support bracket, prevents static discharge to the contacts. Static electricity from an operator's touch travels from the actuator through the bushing and bracket to the PC board.

Award-winning STC contact mechanism with benefits unavailable in conventional mechanisms: smoother, positive detent actuation, increased contact stability and unparalleled logic-level reliability. (Additional STC details in Terms & Acronyms; see Supplement section.)

Smooth, 6mm diameter bushing simplifies panel layout.

Totally sealed body construction prevents contact contamination and allows time- and money-saving soldering and cleaning.

.100" x .100" (2.54mm x 2.54mm) terminal spacing conforms to standard PC board grids.

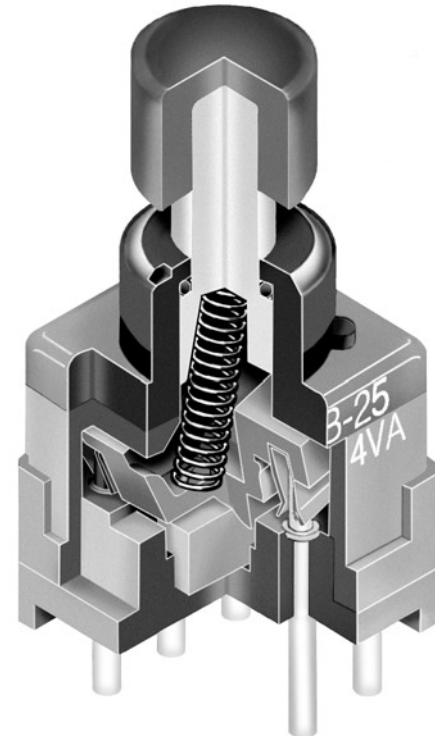

Actual Size



- Toggles
- Rockers
- Pushbuttons**
- Illuminated PB
- Programmable
- Keylocks
- Rotaries
- Slides
- Tactiles
- Tilt
- Touch
- Indicators
- Accessories
- Supplement

### TYPICAL SWITCH ORDERING EXAMPLE



### DESCRIPTION FOR TYPICAL ORDERING EXAMPLE

#### BB15AH-FA



Toggles  
 Rockers  
 Pushbuttons  
 Illuminated PB  
 Programmable  
 Keylocks  
 Rotaries  
 Slides  
 Tactiles  
 Tilt  
 Touch  
 Indicators  
 Accessories  
 Supplement

## POLES & CIRCUITS

Pole	Model	Plunger Position ( ) = Momentary		Connected Terminals		Throw & Schematics
		Normal	Down	Normal	Down	
SP	BB15 BB16	ON ON	(ON) ON	2-3	2-1	SPDT 
DP	BB25 BB26	ON ON	(ON) ON	2-3 5-6	2-1 5-4	DPDT 

## PLUNGERS

**A** .213" (5.4mm) Long

Standard Plunger Color: White

Contact factory for other colors and lengths.

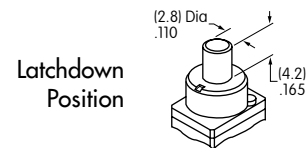
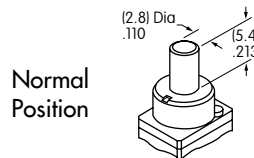

## PC TERMINALS

Use of a support bracket is recommended to increase PCB mounting strength and stability.

Both single pole and double pole alternate action models have double pole bases.

See Typical Switch Dimensions for details.

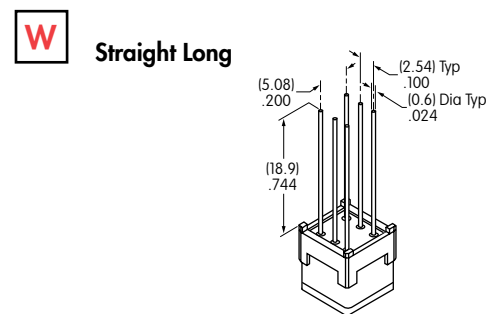
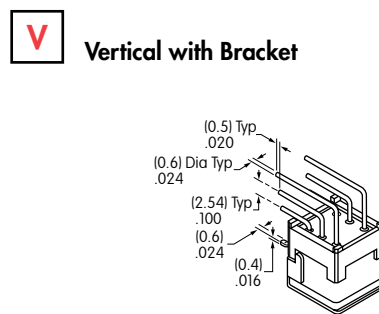
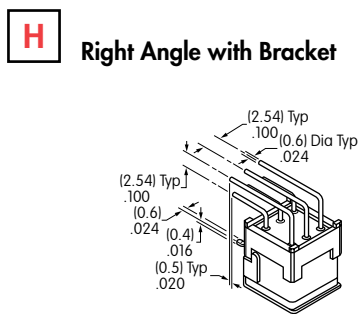
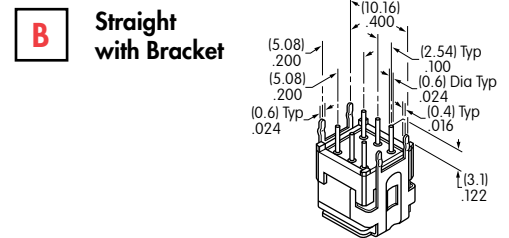
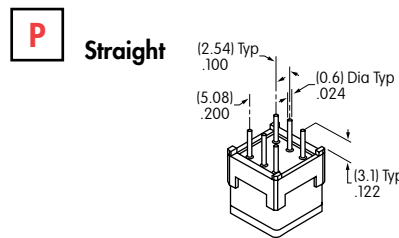

## SLIP-ON CAPS

**F** AT475  
.201" (5.1mm) Diameter Cap



Material: Polyamide

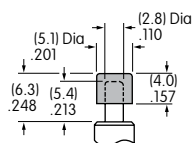

**H** AT496  
.295" (7.5mm) Diameter Cap



Material: Polyamide

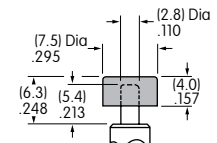

Colors Available:

**A** Black

**B** White

**C** Red

## TYPICAL SWITCH DIMENSIONS

### Straight PC

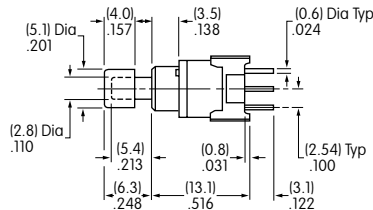
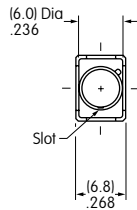

### Single Pole

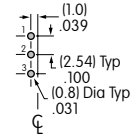
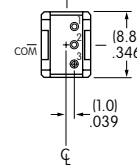

**BB15AP-FA**

Momentary

### Straight PC

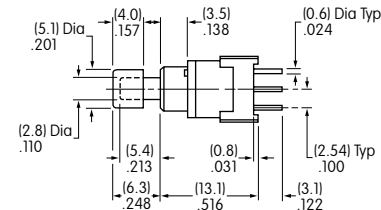
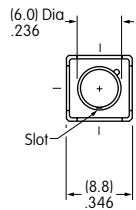

### Double Pole

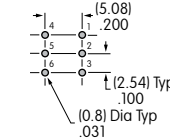
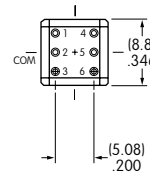

### BB16AP

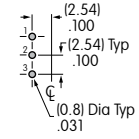
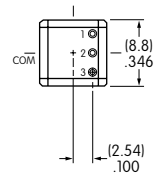

**BB25AP-FA**

Momentary & Alternate

Alternate

### Straight PC • Bracket

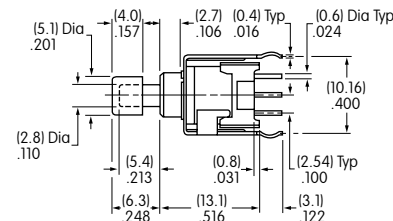
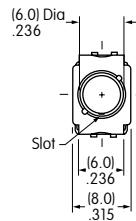

### Single Pole

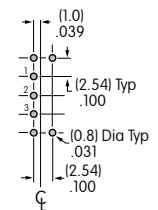
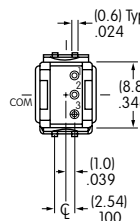

**BB15AB-FA**

Momentary

### Straight PC • Bracket

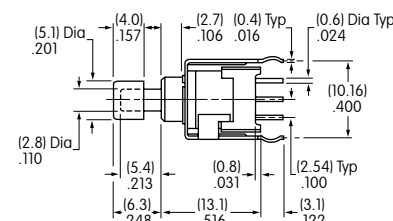
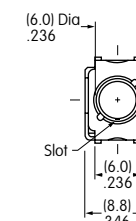

### Double Pole

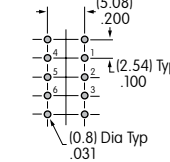
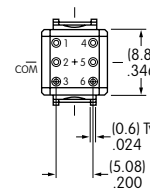

### BB16AB

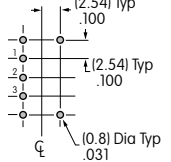
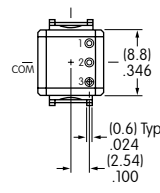

**BB25AB-FA**

Momentary & Alternate

Alternate

Toggles  
Rockers  
Pushbuttons  
Illuminated PB  
Programmable  
Keylocks  
Rotaries  
Slides  
Tactiles  
Tilt  
Touch  
Indicators  
Accessories  
Supplement

## TYPICAL SWITCH DIMENSIONS

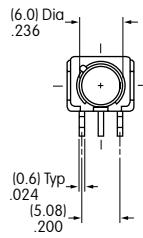

**Single Pole**

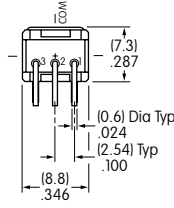

Momentary

**Right Angle PC**



**BB15AH-FA**

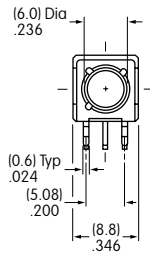

**Double Pole**

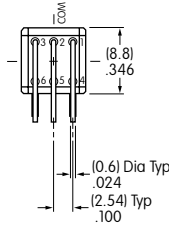

**BB16AH**

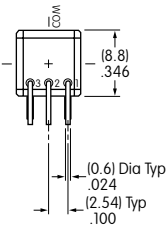

**Right Angle PC**



**BB25AH-FA**

Momentary & Alternate

Alternate

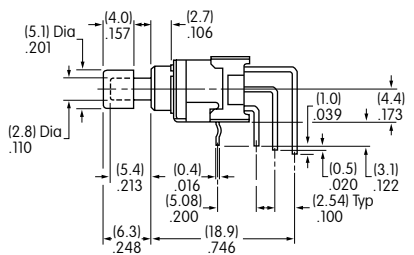
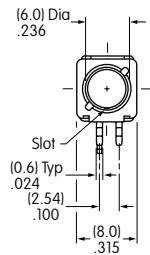

**Single Pole**

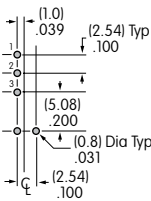
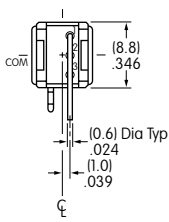

Momentary

**Vertical PC**



**BB15AV-FA**

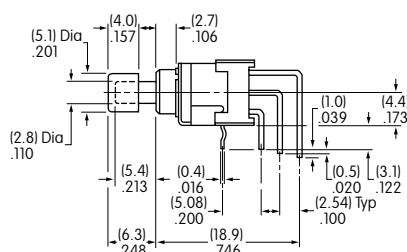
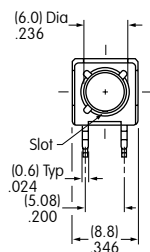

**Double Pole**

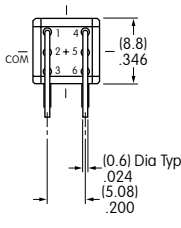

**BB16AV**

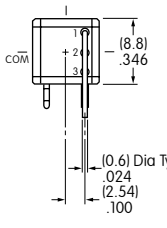

**Vertical PC**



**BB25AV-FA**

Momentary & Alternate

Alternate



Компания «ЭлектроПласт» предлагает заключение долгосрочных отношений при поставках импортных электронных компонентов на взаимовыгодных условиях!

Наши преимущества:

- Оперативные поставки широкого спектра электронных компонентов отечественного и импортного производства напрямую от производителей и с крупнейших мировых складов;
- Поставка более 17-ти миллионов наименований электронных компонентов;
- Поставка сложных, дефицитных, либо снятых с производства позиций;
- Оперативные сроки поставки под заказ (от 5 рабочих дней);
- Экспресс доставка в любую точку России;
- Техническая поддержка проекта, помощь в подборе аналогов, поставка прототипов;
- Система менеджмента качества сертифицирована по Международному стандарту ISO 9001;
- Лицензия ФСБ на осуществление работ с использованием сведений, составляющих государственную тайну;
- Поставка специализированных компонентов (Xilinx, Altera, Analog Devices, Intersil, Interpoint, Microsemi, Aeroflex, Peregrine, Syfer, Eurofarad, Texas Instrument, Miteq, Cobham, E2V, MA-COM, Hittite, Mini-Circuits, General Dynamics и др.);

Помимо этого, одним из направлений компании «ЭлектроПласт» является направление «Источники питания». Мы предлагаем Вам помощь Конструкторского отдела:

- Подбор оптимального решения, техническое обоснование при выборе компонента;
- Подбор аналогов;
- Консультации по применению компонента;
- Поставка образцов и прототипов;
- Техническая поддержка проекта;
- Защита от снятия компонента с производства.



#### Как с нами связаться

**Телефон:** 8 (812) 309 58 32 (многоканальный)

**Факс:** 8 (812) 320-02-42

**Электронная почта:** [org@eplast1.ru](mailto:org@eplast1.ru)

**Адрес:** 198099, г. Санкт-Петербург, ул. Калинина, дом 2, корпус 4, литера А.