

PRODUCT NUMBER
SEE PART NO. TABLE

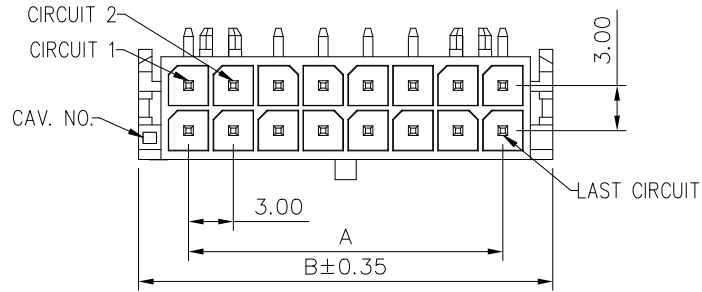

- NOTE:
- MATERIAL:
HOUSING: PA9T, UL94V-0.
CONTACT: HIGH CONDUCTIVITY COPPER ALLOY.
 - CONTACT FINISH: NICKEL UNDERPLATED. OPTIONAL PLATING ON CONTACT AREA & SOLDER TAIL.
 - THIS PLUG MATES WITH FCI RECEPTACLE WIRE CONNECTOR 10132445.
 - PRODUCT SPECIFICATION: GS-12-1291.
 - THE PART IS APPLICABLE FOR PIP PROCESS AND WITHSTAND EXPOSURE TO 260°C PEAK TEMPERATURE FOR 5 SECONDS IN A CONVENTION REFLOW OVEN.

7. PART NUMBER SCHEME:
10142446- XX X X X X LF

POS CODE:
02: 2 POS
04: 4 POS
8: 8 POS
24: 24 POS

PLATING CODE:
1: GOLD FLASH
2: MATTE TIN

PACKAGE:
T: TRAY
R: TAPE & REEL

HSG MATERIAL:
G: PA9T

HSG COLOR:
1: BLACK
2: YELLOW

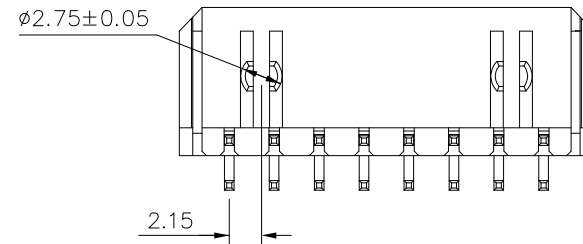
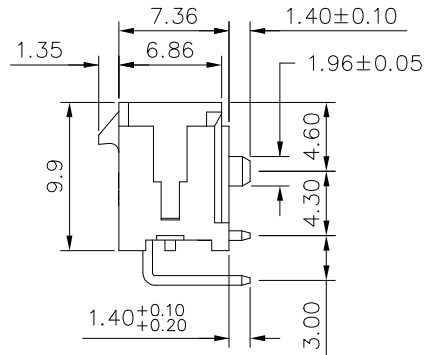
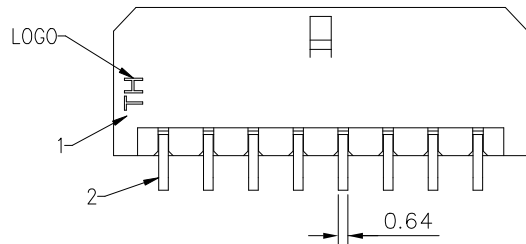

POS	A	B	POS	A	B
2	-	6.65	14	18.00	24.65
4	3.00	9.65	16	21.00	27.65
6	6.00	12.65	18	24.00	30.65
8	9.00	15.65	20	27.00	33.65
10	12.00	18.65	22	30.00	36.65
12	15.00	21.65	24	33.00	39.65

INDEX	PART NAME	MATERIAL	FINISH
1	CONTACT	COPPER ALLOY, 0.64mm SQUARE PIN	
2	INSULATION	NYLON 9T, UL94V-0 (HALOGEN FREE);	

mat'l. code		surface		tolerance		projection		product family	
ltr		ecn no		dr		date		MINITEK PWR3.0 HCC	
A		TONY		2017-02-13		angles		title	
B		ELX-N-26436		TONY		2017-03-22		MINITEK PWR3.0 R/A HEADER	
C		ELX-N-26824		TONY		2017-04-27		HIGH CURRENT, FOR PIP	
dr		TONY_LENG		2017-02-13		linear		scale N.T.S.	
enr		TONY_LENG		2017-02-13		mm		dwg no	
chr		ZK_HU		2017-02-13		mm		sheet 1 of 4	
appd		TIM_YAO		2017-02-13		mm		size	
sheet index		revision sheet		c		c		Amphenol FCI	
1		2		3		4		10142446	
								Product Customer Drawing	
								type	



OUTLINE OF DIFFERENT PIN COUNTS

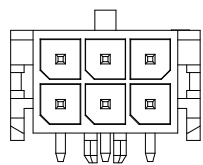

6 POS

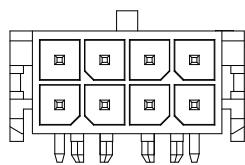

8 POS

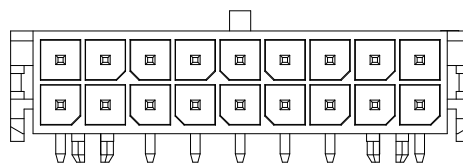

18 POS

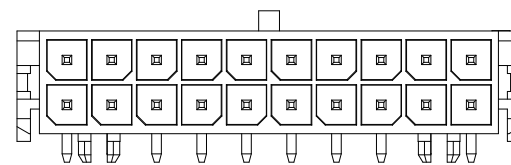

20 POS

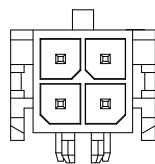

4 POS

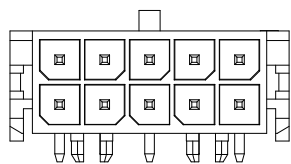

10 POS

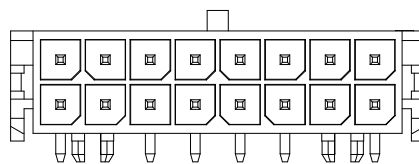

16 POS

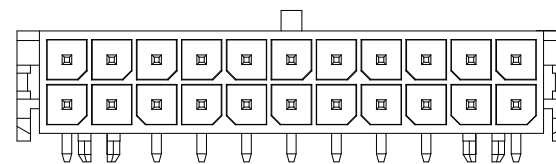

22 POS

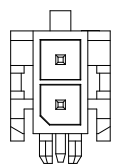

2 POS

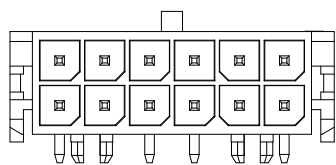

12 POS

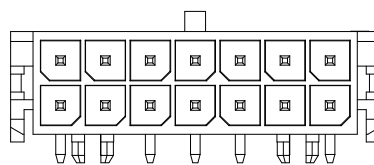

14 POS

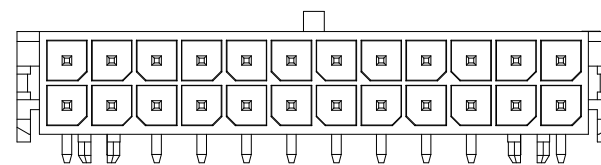

24 POS

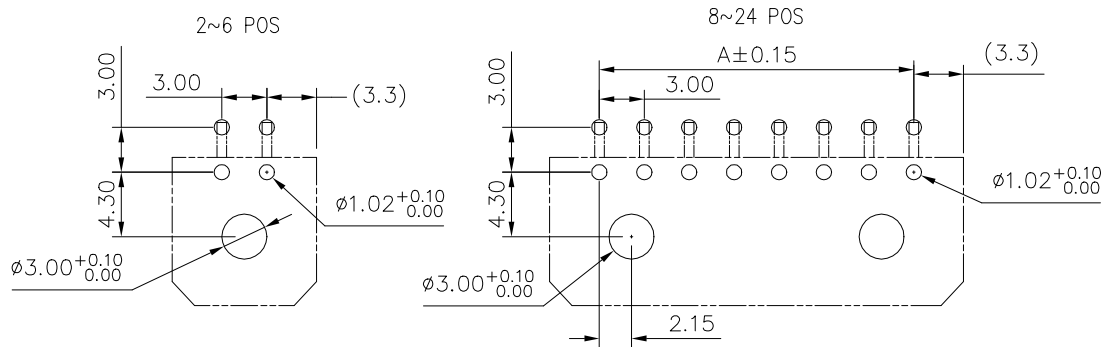

PCB THICKNESS=1.5mm. TOLERANCE: ± 0.05
 RECOMMENDED P.C.B. Layout
 TOP VIEW

mat'l. code		surface <input checked="" type="checkbox"/> tolerance		projection	product family	
ltr	ecn no	dr	date	 mm scale N.T.S.	MINITEK PWR3.0 HCC	
					title	
					MINITEK PWR3.0 R/A HEADER	
					HIGH CURRENT, FOR PIP	
		dr	TONY LENG 2017-02-13		dwg no sheet 2 of 4 size	
		enr	TONY LENG 2017-02-13		10142446 A4	
		chr	ZK_HU 2017-02-13		type Product Customer Drawing	
		appd	TIM_YAO 2017-02-13			
sheet index	revision sheet	c	c	c	c	
		1	2	3	4	

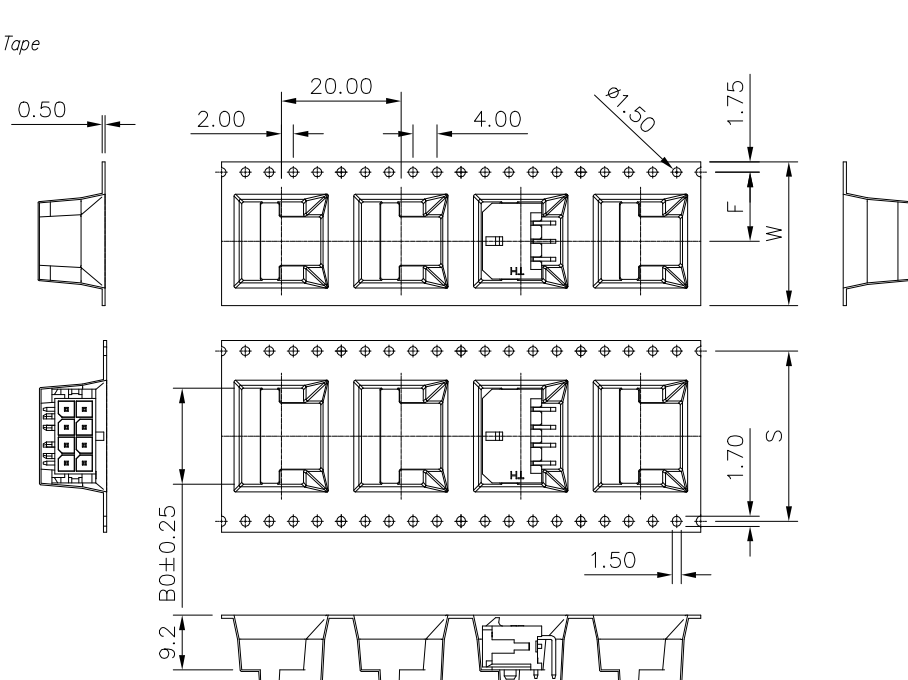
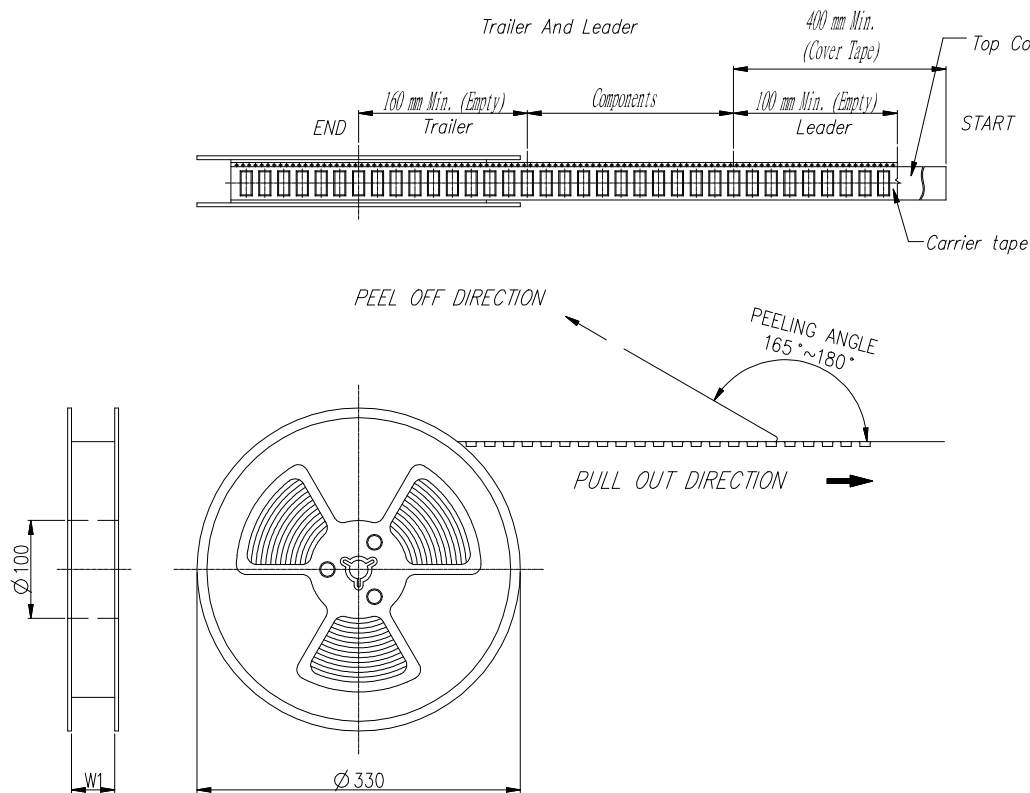

POS	B0	F	S	W	W1	POS	B0	F	S	W	W1
2	7.05	7.50	--	16.00	16.50	14	25.05	20.20	40.40	44.00	44.50
4	10.05	11.50	--	24.00	24.50	16	28.05	20.20	40.40	44.00	44.50
6	13.05	11.50	--	24.00	24.50	18	31.05	20.20	40.40	44.00	44.50
8	16.05	14.20	28.40	32.00	32.50	20	34.05	26.20	52.40	56.00	56.50
10	19.05	14.20	28.40	32.00	32.50	22	37.05	26.20	52.40	56.00	56.50
12	22.05	20.20	40.40	44.00	44.50	24	40.05	26.20	52.40	56.00	56.50

1. 10 SPROCKET HOLE PITCH CUMULATIVE TOLERANCE ±0.20
2. CARRIER CAMBER IS WITHIN 1 mm IN 250 mm
3. THE TOTAL TEARING CONTROL RANGE OF TOP COVER TAPE IS 10~130g, REFERENCE SPEC: EIA-481-D
4. PEELING SPEED: 300mm/MINUTES, REFERENCE SPEC: EIA-481-D
5. MATERIAL: TRANSPARENT CONDUCTIVE POLYSTYRENE ALLOY.
6. ALL DIMENSIONS MEET EIA-481-D REQUIREMENTS
7. THICKNESS : 0.40±0.05mm
8. BAG BEFORE SEALING PRODUCT SHOULD BE PUT 1-2 BAGS IN DESICCANT

mat'l. code		surface <input checked="" type="checkbox"/> tolerance		projection		product family	
ltr		ecn no		dr		date	
tolerances unless otherwise specified		angles		mm		title	
linear .X±0.35		°±5° .XX±0.25		scale N.T.S.		MINITEK PWR3.0 R/A HEADER	
dr TONY LENG 2017-02-13		engr TONY LENG 2017-02-13		chr ZK_HU 2017-02-13		dwg no 10142446	
appd TIM_YAO 2017-02-13		sheet 3 of 4		size A4		type Product Customer Drawing	
sheet index	revision sheet	c 1	c 2	c 3	c 4		

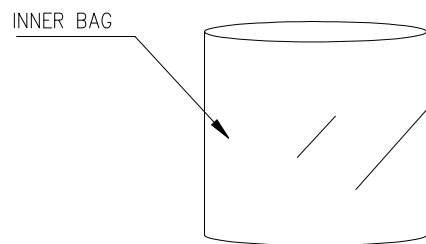
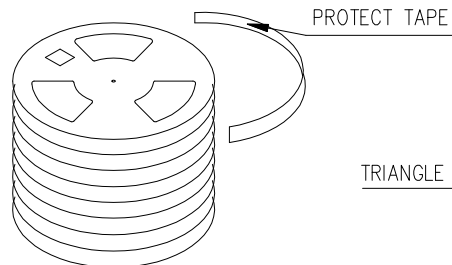
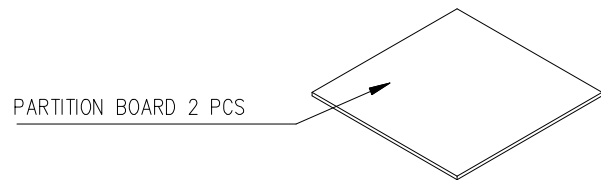

TRIANGLE BOARD 4 PCS

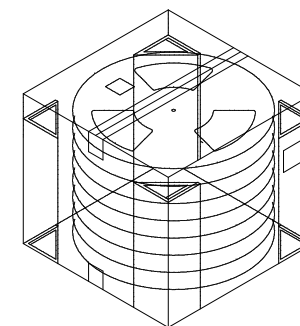
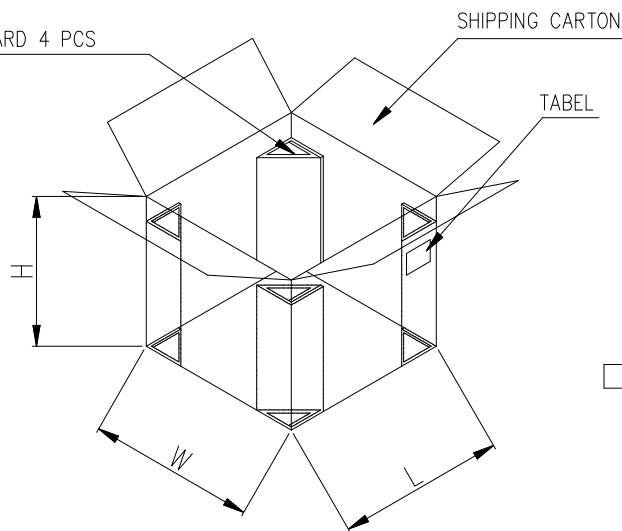

PACKING MATERIAL		PACKING CAPACITY			
PART NAME	DIM.(mm)	POS	PCS/RE	RE/BC	PCS/BC
REEL	∅ 330*(W+0.5)	2	300	12	3,600
CARTON	350*350*340	4~6	300	9	2,700
		8~10	300	7	2,100
		12~18	300	6	1,800
		20~24	300	5	1,500

A

A

B

B

mat'l. code		surface <input checked="" type="checkbox"/> tolerance		projection		product family MINITEK PWR3.0 HCC	
ltr	ecn no	dr	date	tolerances unless otherwise specified		title	
				angles	linear	MINITEK PWR3.0 R/A HEADER	
						HIGH CURRENT, FOR PIP	
				∅±5*		scale N.T.S.	
		dr	TONY LENG	2017-02-13	dwg no		sheet 4 of 4
		enr	TONY LENG	2017-02-13	size		A4
		chr	ZK_HU	2017-02-13	type		Product Customer Drawing
		appd	TIM_YAO	2017-02-13	10142446		
sheet index	revision sheet	1	2	c	c	c	c



Компания «ЭлектроПласт» предлагает заключение долгосрочных отношений при поставках импортных электронных компонентов на взаимовыгодных условиях!

Наши преимущества:

- Оперативные поставки широкого спектра электронных компонентов отечественного и импортного производства напрямую от производителей и с крупнейших мировых складов;
- Поставка более 17-ти миллионов наименований электронных компонентов;
- Поставка сложных, дефицитных, либо снятых с производства позиций;
- Оперативные сроки поставки под заказ (от 5 рабочих дней);
- Экспресс доставка в любую точку России;
- Техническая поддержка проекта, помощь в подборе аналогов, поставка прототипов;
- Система менеджмента качества сертифицирована по Международному стандарту ISO 9001;
- Лицензия ФСБ на осуществление работ с использованием сведений, составляющих государственную тайну;
- Поставка специализированных компонентов (Xilinx, Altera, Analog Devices, Intersil, Interpoint, Microsemi, Aeroflex, Peregrine, Syfer, Eurofarad, Texas Instrument, Miteq, Cobham, E2V, MA-COM, Hittite, Mini-Circuits, General Dynamics и др.);

Помимо этого, одним из направлений компании «ЭлектроПласт» является направление «Источники питания». Мы предлагаем Вам помощь Конструкторского отдела:

- Подбор оптимального решения, техническое обоснование при выборе компонента;
- Подбор аналогов;
- Консультации по применению компонента;
- Поставка образцов и прототипов;
- Техническая поддержка проекта;
- Защита от снятия компонента с производства.



Как с нами связаться

Телефон: 8 (812) 309 58 32 (многоканальный)

Факс: 8 (812) 320-02-42

Электронная почта: org@eplast1.ru

Адрес: 198099, г. Санкт-Петербург, ул. Калинина, дом 2, корпус 4, литера А.