



## MICRO-CON-X<sup>®</sup> 2-7

NEW PRODUCT BULLETIN C708

# CONXALL<sup>®</sup>

A SWITCHCRAFT COMPANY



CONXALL • 601 E Wildwood • Villa Park, IL 60181 • 630-834-7504  
Please visit [conxall.com](http://conxall.com) for the most up-to-date product specifications. Made in USA.

# MICRO-CON-X® 2-7

NEW PRODUCT BULLETIN C708



## FEATURES & BENEFITS

- Up to 7 contacts in compact design
- IP-67 rating, at the face (when mated)
- IP-67 molded cable assemblies (when mated)
- All plastic design is light weight
- Variety of standard options to meet all design specifications
- Custom cable assemblies available
- UL recognized

## APPLICATIONS

- Instrumentation
- Medical Equipment
- Lighting
- GPS Locating Devices
- Data Acquisition
- General industrial electronic applications



# MICRO-CON-X<sup>®</sup> 2-7

## NEW PRODUCT BULLETIN C708

### SPECIFICATIONS

#### Mechanical Specifications

Life:	Minimum 300 cycles insertion / withdrawal cycles
Vibration:	Coupling rings have overriding locking feature to prevent loosening or separation of connector
Hex Nut Torque:	9 in-lb max tightening torque.
Coupling Locking Style:	Bayonet with ribbed coupling nut (winged coupling nut available) P/N 16482
Backshell Style:	Non-removable snap lock
Conductor Sizes:	#20 accepts 20 through 24 AWG #22 contacts accepts 22 through 24 AWG #26 contacts accepts 24 through 28 AWG

#### Electrical Specifications

Voltage Rating:	600V AC/DC
Current Rating:	7.5 A – max (See Electrical Current Rating Chart)

#### Environmental Specifications

Operating Temperature Rating:	-40°C to +85°C (-40°F to +185°F)
Salt Atmosphere (Corrosion):	300 Hr salt spray when mated
Weathertight:	IP67 at the face, when mated

#### Material Specifications

Backshell:	Thermoplastic, UL 94HB, Black
Contacts:	Copper Alloy, Gold over Nickel Plate
Coupling Ring:	Thermoplastic, UL 94HB, Black
Gasket:	Elastomer, Black
Grommet / Strain Relief:	Elastomer, Black
Hex Nut:	Thermoplastic, UL 94HB, Black
O-Ring:	Elastomer, Black
Shell:	Thermoplastic, UL 94HB, Black
Optional Dust Cap:	Elastomer, Black

#### Molded Cable Assemblies

Weathertight:	NEMA 6P, 13: IEC IP67
---------------	-----------------------

#### Certifications

UL File E150822  
CSA File 181200  
Not for current interruption  
RoHS compliant  
REACH compliant

#### Options

UV Rating:	f1 available
Flame Rating:	UL 94-HB; UL 94V-0 available

#### Consult factory for optional colors and materials

CONTACT SIZE	CONDUCTOR SIZE - AWG	NUMBER OF CONDUCTORS	CURRENT RATING
#20	#18	1 through 3	7.5A
	#20	1 through 3	7.5A
#22	#22	4	6.0A
	#24	4	6.0A
#26	#24	5, 6	4.0A
	#26	5, 6	4.0A
	#24	7	3.5A
	#26	7	3.5A
	#28*	5-7	2.0A

\*Not UL tested for this wire conductor size



# MICRO-CON-X<sup>®</sup> 2-7

NEW PRODUCT BULLETIN C708

## PANEL MOUNT / CABLE TO CABLE CONNECTORS

Front View | Wire View



2 POSITION  
#20 PIN & SOCKET  
CONTACT



3 POSITION  
#20 PIN & SOCKET  
CONTACT

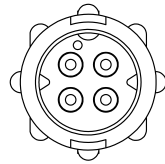

4 POSITION  
#22 PIN & SOCKET  
CONTACT

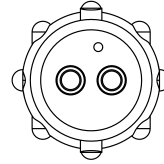

2 POSITION  
#20 PIN & SOCKET  
CONTACT

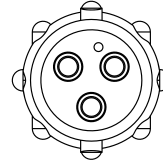

3 POSITION  
#20 PIN & SOCKET  
CONTACT

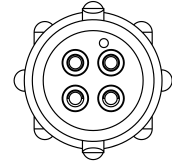

4 POSITION  
#22 PIN & SOCKET  
CONTACT



5 POSITION B-KEY  
#26 PIN & SOCKET  
CONTACT



6 POSITION A-KEY  
#26 PIN & SOCKET  
CONTACT

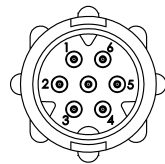

7 POSITION B-KEY  
#26 PIN & SOCKET  
CONTACT

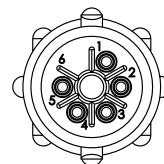

5 POSITION B-KEY  
#26 PIN & SOCKET  
CONTACT

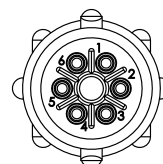

6 POSITION A-KEY  
#26 PIN & SOCKET  
CONTACT

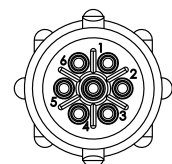

7 POSITION B-KEY  
#26 PIN & SOCKET  
CONTACT

## CABLE CONNECTORS

Front View | Wire View



2 POSITION  
#20 PIN & SOCKET  
CONTACT



3 POSITION  
#20 PIN & SOCKET  
CONTACT



4 POSITION  
#22 PIN & SOCKET  
CONTACT



2 POSITION  
#20 PIN & SOCKET  
CONTACT

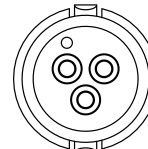

3 POSITION  
#20 PIN & SOCKET  
CONTACT

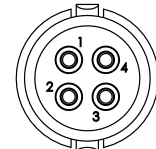

4 POSITION  
#22 PIN & SOCKET  
CONTACT



5 POSITION B-KEY  
#26 PIN & SOCKET  
CONTACT



6 POSITION A-KEY  
#26 PIN & SOCKET  
CONTACT



7 POSITION B-KEY  
#26 PIN & SOCKET  
CONTACT



5 POSITION B-KEY  
#26 PIN & SOCKET  
CONTACT

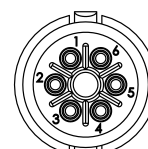

6 POSITION A-KEY  
#26 PIN & SOCKET  
CONTACT

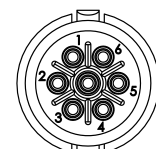

7 POSITION B-KEY  
#26 PIN & SOCKET  
CONTACT



# MICRO-CON-X<sup>®</sup> 2-7

## NEW PRODUCT BULLETIN C708

### CABLE



**16XXX-XXG-5XX**  
FIELD INSTALLABLE  
CABLE CONNECTOR  
BACKSHELL TYPE 5-LONG



**16XXX-XXG-3XX**  
FIELD INSTALLABLE  
CABLE CONNECTOR  
BACKSHELL TYPE 3-SHORT  
\*2 & 3 POSITION ONLY\*

### CABLE TO CABLE



**18XXX-XXG-5XX**  
FIELD INSTALLABLE  
CABLE TO CABLE  
CONNECTOR  
BACKSHELL TYPE 5-LONG



**18XXX-XXG-3XX**  
FIELD INSTALLABLE  
CABLE TO CABLE  
CONNECTOR  
BACKSHELL TYPE 3-SHORT  
\*2 & 3 POSITION ONLY\*

### PANEL



**17X80-XXG-3XX**  
PANEL MOUNT CONNECTOR  
CRIMP



**17X82-XXG-3XX**  
PANEL MOUNT CONNECTOR  
SOLDER CUP



**17X8X-XXG-3XX**  
PANEL MOUNT CONNECTOR  
PC TAIL

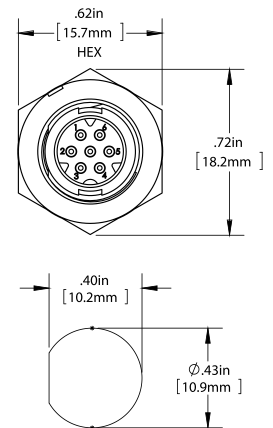

**RECOMMENDED  
PANEL CUT-OUT**  
TOLERANCE: ±.003

\*X, Y, Z - CONSULT FACTORY

All dimensions are for reference only.



# MICRO-CON-X<sup>®</sup> 2-7

NEW PRODUCT BULLETIN C708

## ORDERING CODE

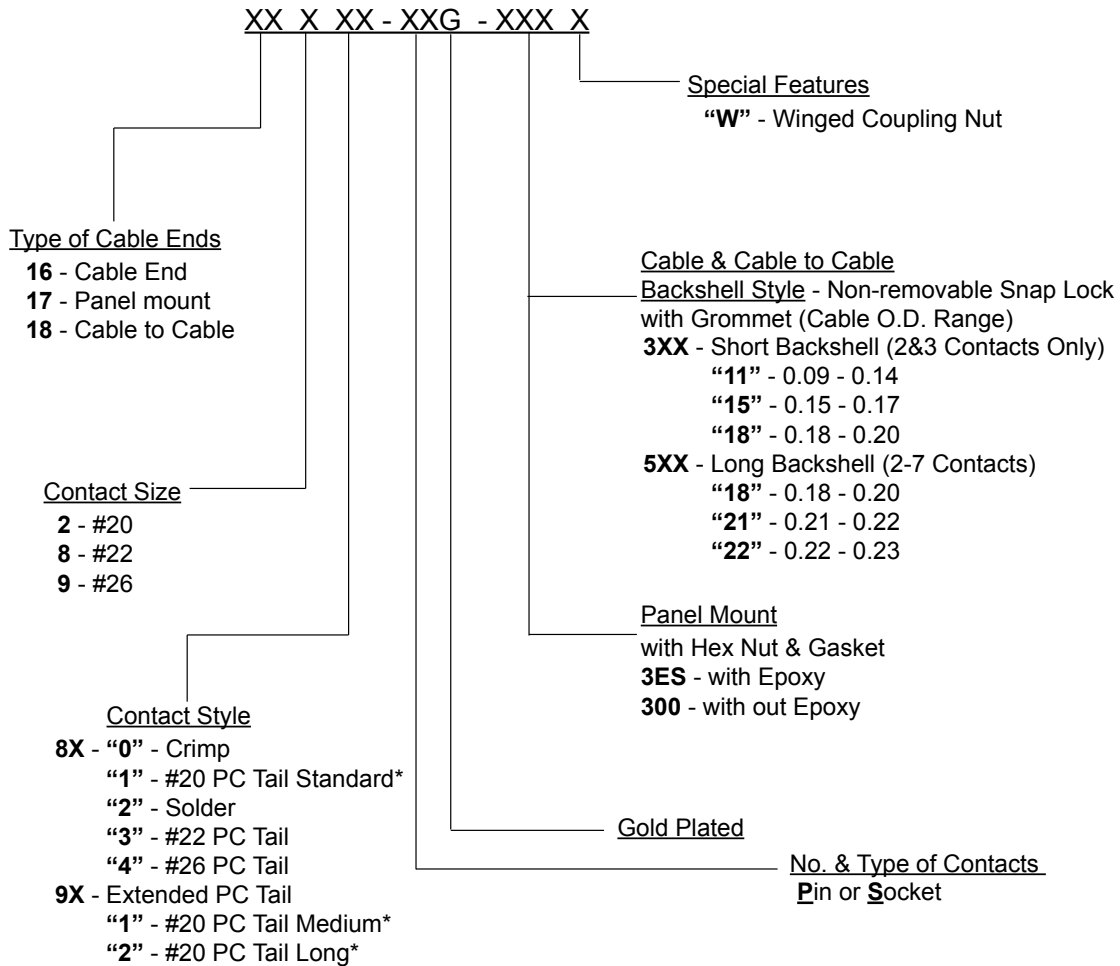

\*Consult factory for length and diameter of PC Tail. Additionally, alternative colors and materials are available.





Компания «ЭлектроПласт» предлагает заключение долгосрочных отношений при поставках импортных электронных компонентов на взаимовыгодных условиях!

Наши преимущества:

- Оперативные поставки широкого спектра электронных компонентов отечественного и импортного производства напрямую от производителей и с крупнейших мировых складов;
- Поставка более 17-ти миллионов наименований электронных компонентов;
- Поставка сложных, дефицитных, либо снятых с производства позиций;
- Оперативные сроки поставки под заказ (от 5 рабочих дней);
- Экспресс доставка в любую точку России;
- Техническая поддержка проекта, помощь в подборе аналогов, поставка прототипов;
- Система менеджмента качества сертифицирована по Международному стандарту ISO 9001;
- Лицензия ФСБ на осуществление работ с использованием сведений, составляющих государственную тайну;
- Поставка специализированных компонентов (Xilinx, Altera, Analog Devices, Intersil, Interpoint, Microsemi, Aeroflex, Peregrine, Syfer, Eurofarad, Texas Instrument, Miteq, Cobham, E2V, MA-COM, Hittite, Mini-Circuits, General Dynamics и др.);

Помимо этого, одним из направлений компании «ЭлектроПласт» является направление «Источники питания». Мы предлагаем Вам помощь Конструкторского отдела:

- Подбор оптимального решения, техническое обоснование при выборе компонента;
- Подбор аналогов;
- Консультации по применению компонента;
- Поставка образцов и прототипов;
- Техническая поддержка проекта;
- Защита от снятия компонента с производства.



#### Как с нами связаться

**Телефон:** 8 (812) 309 58 32 (многоканальный)

**Факс:** 8 (812) 320-02-42

**Электронная почта:** [org@eplast1.ru](mailto:org@eplast1.ru)

**Адрес:** 198099, г. Санкт-Петербург, ул. Калинина, дом 2, корпус 4, литера А.