



MICRO-CON-X[®] 2-7

NEW PRODUCT BULLETIN C708

CONXALL[®]

A SWITCHCRAFT COMPANY



CONXALL • 601 E Wildwood • Villa Park, IL 60181 • 630-834-7504
Please visit conxall.com for the most up-to-date product specifications. Made in USA.

MICRO-CON-X® 2-7

NEW PRODUCT BULLETIN C708



FEATURES & BENEFITS

- Up to 7 contacts in compact design
- IP-67 rating, at the face (when mated)
- IP-67 molded cable assemblies (when mated)
- All plastic design is light weight
- Variety of standard options to meet all design specifications
- Custom cable assemblies available
- UL recognized

APPLICATIONS

- Instrumentation
- Medical Equipment
- Lighting
- GPS Locating Devices
- Data Acquisition
- General industrial electronic applications



MICRO-CON-X® 2-7

NEW PRODUCT BULLETIN C708

SPECIFICATIONS

Mechanical Specifications

Life:	Minimum 300 cycles insertion / withdrawal cycles
Vibration:	Coupling rings have overriding locking feature to prevent loosening or separation of connector
Hex Nut Torque:	9 in-lb max tightening torque.
Coupling Locking Style:	Bayonet with ribbed coupling nut (winged coupling nut available) P/N 16482
Backshell Style:	Non-removable snap lock
Conductor Sizes:	#20 accepts 20 through 24 AWG #22 contacts accepts 22 through 24 AWG #26 contacts accepts 24 through 28 AWG

Electrical Specifications

Voltage Rating:	600V AC/DC
Current Rating:	7.5 A – max (See Electrical Current Rating Chart)

Environmental Specifications

Operating Temperature Rating:	-40°C to +85°C (-40°F to +185°F)
Salt Atmosphere (Corrosion):	300 Hr salt spray when mated
Weatheright:	IP67 at the face, when mated

Material Specifications

Backshell:	Thermoplastic, UL 94HB, Black
Contacts:	Copper Alloy, Gold over Nickel Plate
Coupling Ring:	Thermoplastic, UL 94HB, Black
Gasket:	Elastomer, Black
Grommet / Strain Relief:	Elastomer, Black
Hex Nut:	Thermoplastic, UL 94HB, Black
O-Ring:	Elastomer, Black
Shell:	Thermoplastic, UL 94HB, Black
Optional Dust Cap:	Elastomer, Black

Molded Cable Assemblies

Weatheright:	NEMA 6P, 13: IEC IP67
--------------	-----------------------

Certifications

UL File E150822
CSA File 181200
Not for current interruption
RoHS compliant
REACH compliant

Options

UV Rating:	f1 available
Flame Rating:	UL 94-HB; UL 94V-0 available

Consult factory for optional colors and materials

CONTACT SIZE	CONDUCTOR SIZE - AWG	NUMBER OF CONDUCTORS	CURRENT RATING
#20	#18	1 through 3	7.5A
	#20	1 through 3	7.5A
#22	#22	4	6.0A
	#24	4	6.0A
#26	#24	5, 6	4.0A
	#26	5, 6	4.0A
	#24	7	3.5A
	#26	7	3.5A
	#28*	5-7	2.0A

*Not UL tested for this wire conductor size



MICRO-CON-X[®] 2-7

NEW PRODUCT BULLETIN C708

PANEL MOUNT / CABLE TO CABLE CONNECTORS

Front View | Wire View



2 POSITION
#20 PIN & SOCKET
CONTACT



3 POSITION
#20 PIN & SOCKET
CONTACT

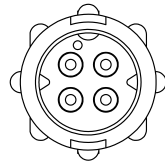

4 POSITION
#22 PIN & SOCKET
CONTACT

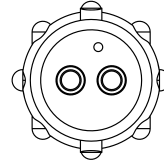

2 POSITION
#20 PIN & SOCKET
CONTACT

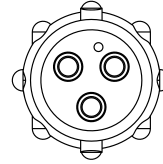

3 POSITION
#20 PIN & SOCKET
CONTACT

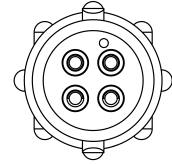

4 POSITION
#22 PIN & SOCKET
CONTACT



5 POSITION B-KEY
#26 PIN & SOCKET
CONTACT



6 POSITION A-KEY
#26 PIN & SOCKET
CONTACT

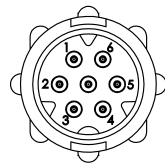

7 POSITION B-KEY
#26 PIN & SOCKET
CONTACT

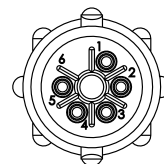

5 POSITION B-KEY
#26 PIN & SOCKET
CONTACT

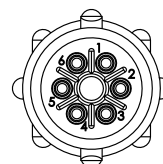

6 POSITION A-KEY
#26 PIN & SOCKET
CONTACT

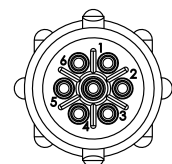

7 POSITION B-KEY
#26 PIN & SOCKET
CONTACT

CABLE CONNECTORS

Front View | Wire View



2 POSITION
#20 PIN & SOCKET
CONTACT

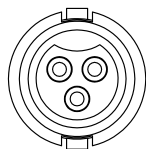

3 POSITION
#20 PIN & SOCKET
CONTACT

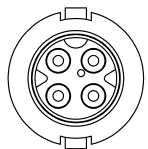

4 POSITION
#22 PIN & SOCKET
CONTACT

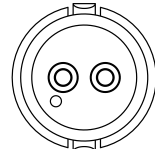

2 POSITION
#20 PIN & SOCKET
CONTACT

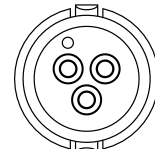

3 POSITION
#20 PIN & SOCKET
CONTACT

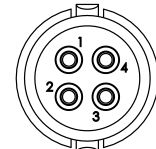

4 POSITION
#22 PIN & SOCKET
CONTACT



5 POSITION B-KEY
#26 PIN & SOCKET
CONTACT

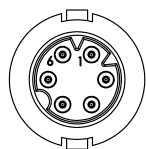

6 POSITION A-KEY
#26 PIN & SOCKET
CONTACT

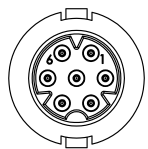

7 POSITION B-KEY
#26 PIN & SOCKET
CONTACT

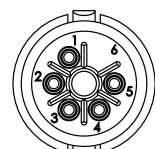

5 POSITION B-KEY
#26 PIN & SOCKET
CONTACT

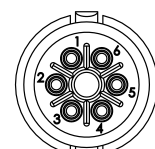

6 POSITION A-KEY
#26 PIN & SOCKET
CONTACT

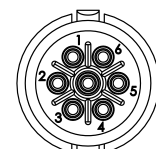

7 POSITION B-KEY
#26 PIN & SOCKET
CONTACT



MICRO-CON-X[®] 2-7

NEW PRODUCT BULLETIN C708

CABLE



16XXX-XXG-5XX
FIELD INSTALLABLE
CABLE CONNECTOR
BACKSHELL TYPE 5-LONG



16XXX-XXG-3XX
FIELD INSTALLABLE
CABLE CONNECTOR
BACKSHELL TYPE 3-SHORT
2 & 3 POSITION ONLY

CABLE TO CABLE



18XXX-XXG-5XX
FIELD INSTALLABLE
CABLE TO CABLE
CONNECTOR
BACKSHELL TYPE 5-LONG



18XXX-XXG-3XX
FIELD INSTALLABLE
CABLE TO CABLE
CONNECTOR
BACKSHELL TYPE 3-SHORT
2 & 3 POSITION ONLY

PANEL



17X80-XXG-3XX
PANEL MOUNT CONNECTOR
CRIMP



17X82-XXG-3XX
PANEL MOUNT CONNECTOR
SOLDER CUP

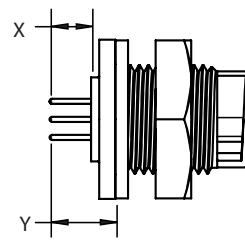

17X8X-XXG-3XX
PANEL MOUNT CONNECTOR
PC TAIL

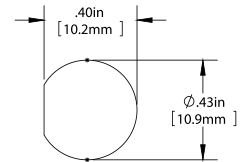

**RECOMMENDED
PANEL CUT-OUT**
TOLERANCE: ±.003

*X, Y, Z - CONSULT FACTORY

All dimensions are for reference only.



MICRO-CON-X[®] 2-7

NEW PRODUCT BULLETIN C708

ORDERING CODE

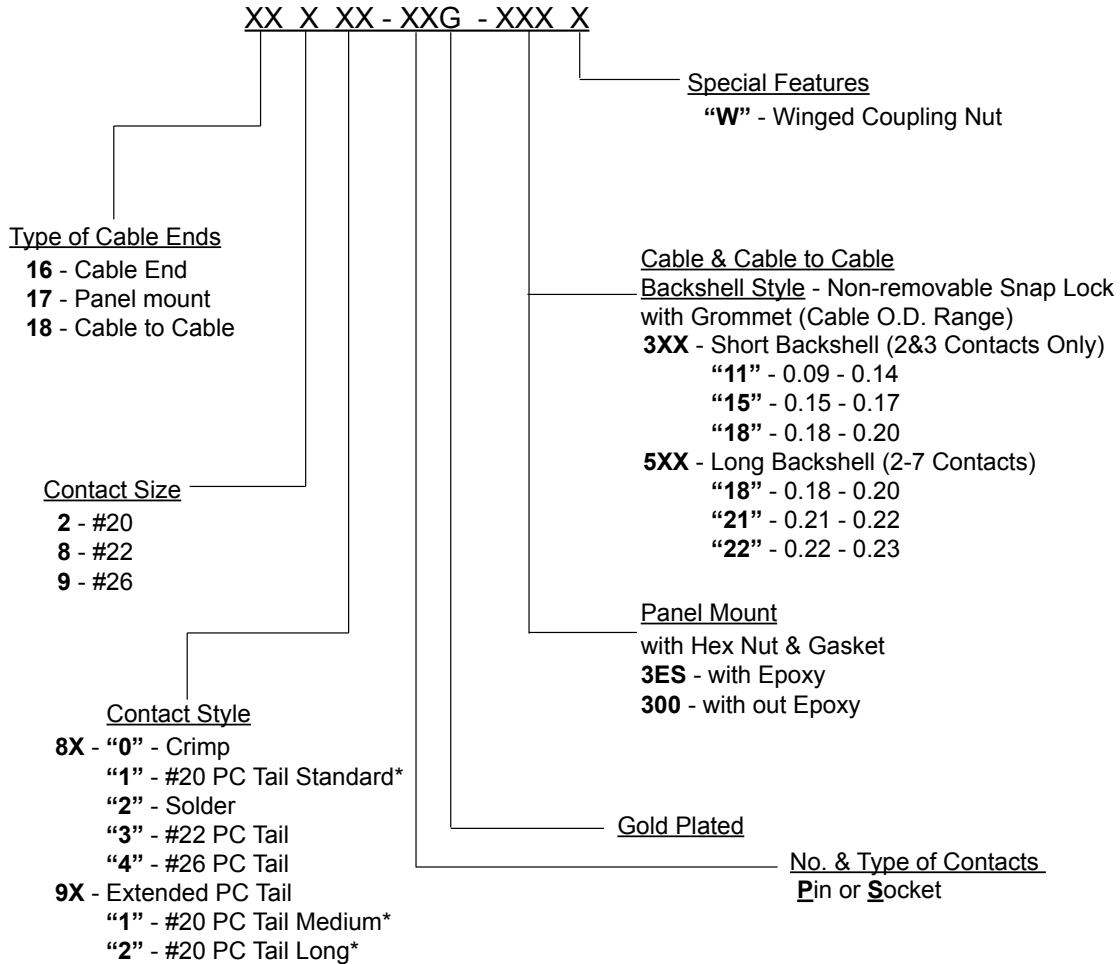

*Consult factory for length and diameter of PC Tail. Additionally, alternative colors and materials are available.





Компания «ЭлектроПласт» предлагает заключение долгосрочных отношений при поставках импортных электронных компонентов на взаимовыгодных условиях!

Наши преимущества:

- Оперативные поставки широкого спектра электронных компонентов отечественного и импортного производства напрямую от производителей и с крупнейших мировых складов;
- Поставка более 17-ти миллионов наименований электронных компонентов;
- Поставка сложных, дефицитных, либо снятых с производства позиций;
- Оперативные сроки поставки под заказ (от 5 рабочих дней);
- Экспресс доставка в любую точку России;
- Техническая поддержка проекта, помощь в подборе аналогов, поставка прототипов;
- Система менеджмента качества сертифицирована по Международному стандарту ISO 9001;
- Лицензия ФСБ на осуществление работ с использованием сведений, составляющих государственную тайну;
- Поставка специализированных компонентов (Xilinx, Altera, Analog Devices, Intersil, Interpoint, Microsemi, Aeroflex, Peregrine, Syfer, Eurofarad, Texas Instrument, Miteq, Cobham, E2V, MA-COM, Hittite, Mini-Circuits, General Dynamics и др.);

Помимо этого, одним из направлений компании «ЭлектроПласт» является направление «Источники питания». Мы предлагаем Вам помощь Конструкторского отдела:

- Подбор оптимального решения, техническое обоснование при выборе компонента;
- Подбор аналогов;
- Консультации по применению компонента;
- Поставка образцов и прототипов;
- Техническая поддержка проекта;
- Защита от снятия компонента с производства.



Как с нами связаться

Телефон: 8 (812) 309 58 32 (многоканальный)

Факс: 8 (812) 320-02-42

Электронная почта: org@eplast1.ru

Адрес: 198099, г. Санкт-Петербург, ул. Калинина, дом 2, корпус 4, литера А.