

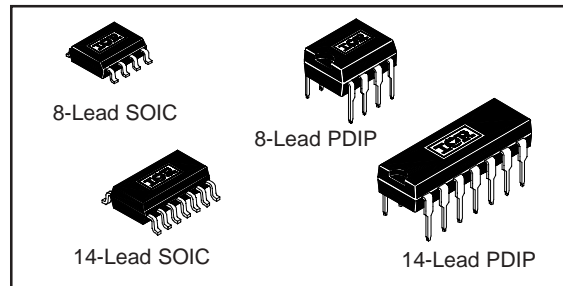
## IR2106(4)(S) & (PbF)

### HIGH AND LOW SIDE DRIVER

#### Features

- Floating channel designed for bootstrap operation  
Fully operational to +600V  
Tolerant to negative transient voltage  
dV/dt immune
- Gate drive supply range from 10 to 20V (IR2106(4))
- Undervoltage lockout for both channels
- 3.3V, 5V and 15V input logic compatible
- Matched propagation delay for both channels
- Logic and power ground +/- 5V offset.
- Lower di/dt gate driver for better noise immunity
- Outputs in phase with inputs (IR2106)
- Also available LEAD-FREE

#### Packages



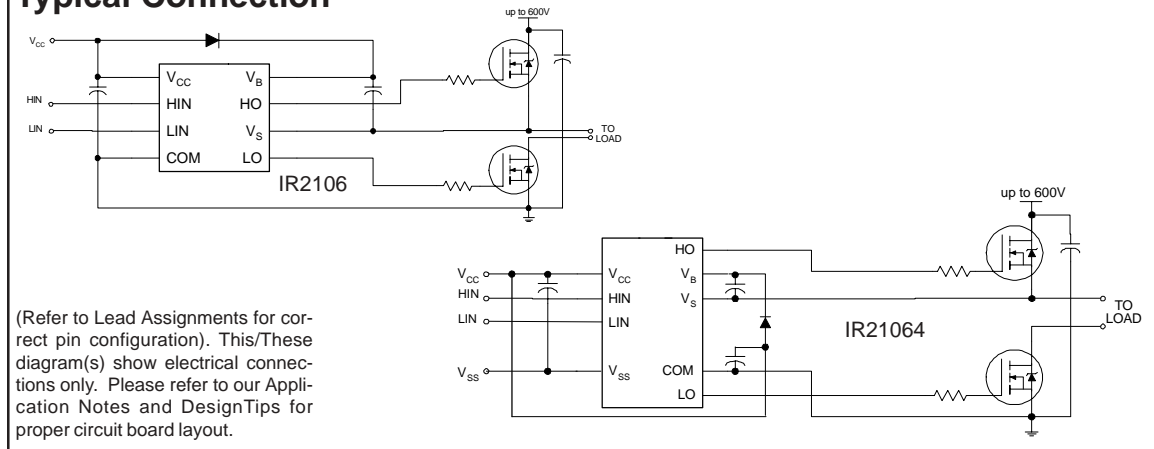
#### Description

The IR2106(4)(S) are high voltage, high speed power MOSFET and IGBT drivers with independent high and low side referenced output channels. Proprietary HVIC and latch immune CMOS technologies enable ruggedized monolithic construction. The logic input is compatible with standard CMOS or LSTTL output, down to 3.3V logic. The output drivers feature a high pulse current buffer stage designed for minimum driver cross-conduction. The floating channel can be used to drive an N-channel power MOSFET or IGBT in the high side configuration which operates up to 600 volts.

#### 2106/2301//2108//2109/2302/2304 Feature Comparison

Part	Input logic	Cross-conduction prevention logic	Dead-Time	Ground Pins	Ton/Toff
2106/2301	HIN/LIN	no	none	COM	220/200
21064				VSS/COM	
2108	HIN/LIN	yes	Internal 540ns	COM	220/200
21084			Programmable 0.54-5µs	VSS/COM	
2109/2302	IN/SD	yes	Internal 540ns	COM	750/200
21094			Programmable 0.54-5µs	VSS/COM	
2304	HIN/LIN	yes	Internal 100ns	COM	160/140

#### Typical Connection



## Absolute Maximum Ratings

Absolute maximum ratings indicate sustained limits beyond which damage to the device may occur. All voltage parameters are absolute voltages referenced to COM. The thermal resistance and power dissipation ratings are measured under board mounted and still air conditions.

Symbol	Definition	Min.	Max.	Units	
V <sub>B</sub>	High side floating absolute voltage	-0.3	625	V	
V <sub>S</sub>	High side floating supply offset voltage	V <sub>B</sub> - 25	V <sub>B</sub> + 0.3		
V <sub>HO</sub>	High side floating output voltage	V <sub>S</sub> - 0.3	V <sub>B</sub> + 0.3		
V <sub>CC</sub>	Low side and logic fixed supply voltage	-0.3	25		
V <sub>LO</sub>	Low side output voltage	-0.3	V <sub>CC</sub> + 0.3		
V <sub>IN</sub>	Logic input voltage	V <sub>SS</sub> - 0.3	V <sub>CC</sub> + 0.3		
V <sub>SS</sub>	Logic ground (IR21064 only)	V <sub>CC</sub> - 25	V <sub>CC</sub> + 0.3		
dV <sub>S</sub> /dt	Allowable offset supply voltage transient	—	50	V/ns	
P <sub>D</sub>	Package power dissipation @ T <sub>A</sub> ≤ +25°C	(8 lead PDIP)	—	1.0	W
		(8 lead SOIC)	—	0.625	
		(14 lead PDIP)	—	1.6	
		(14 lead SOIC)	—	1.0	
R <sub>thJA</sub>	Thermal resistance, junction to ambient	(8 lead PDIP)	—	125	°C/W
		(8 lead SOIC)	—	200	
		(14 lead PDIP)	—	75	
		(14 lead SOIC)	—	120	
T <sub>J</sub>	Junction temperature	—	150	°C	
T <sub>S</sub>	Storage temperature	-50	150		
T <sub>L</sub>	Lead temperature (soldering, 10 seconds)	—	300		

## Recommended Operating Conditions

The Input/Output logic timing diagram is shown in figure 1. For proper operation the device should be used within the recommended conditions. The  $V_S$  and  $V_{SS}$  offset rating are tested with all supplies biased at 15V differential.

Symbol	Definition	Min.	Max.	Units
$V_B$	High side floating supply absolute voltage IR2106(4)	$V_S + 10$	$V_S + 20$	V
$V_S$	High side floating supply offset voltage	Note 1	600	
$V_{HO}$	High side floating output voltage	$V_S$	$V_B$	
$V_{CC}$	Low side and logic fixed supply voltage IR2106(4)	10	20	
$V_{LO}$	Low side output voltage	0	$V_{CC}$	
$V_{IN}$	Logic input voltage	$V_{SS}$	$V_{CC}$	
$V_{SS}$	Logic ground (IR21064 only)	-5	5	
$T_A$	Ambient temperature	-40	125	°C

Note 1: Logic operational for  $V_S$  of -5 to +600V. Logic state held for  $V_S$  of -5V to  $-V_{BS}$ . (Please refer to the Design Tip DT97-3 for more details).

## Dynamic Electrical Characteristics

$V_{BIAS} (V_{CC}, V_{BS}) = 15V$ ,  $V_{SS} = COM$ ,  $C_L = 1000 pF$ ,  $T_A = 25^\circ C$ .

Symbol	Definition	Min.	Typ.	Max.	Units	Test Conditions
$t_{on}$	Turn-on propagation delay	—	220	300	nsec	$V_S = 0V$
$t_{off}$	Turn-off propagation delay	—	200	280		$V_S = 0V$ or 600V
MT	Delay matching, HS & LS turn-on/off	—	0	30		
$t_r$	Turn-on rise time	—	150	220		$V_S = 0V$
$t_f$	Turn-off fall time	—	50	80		$V_S = 0V$

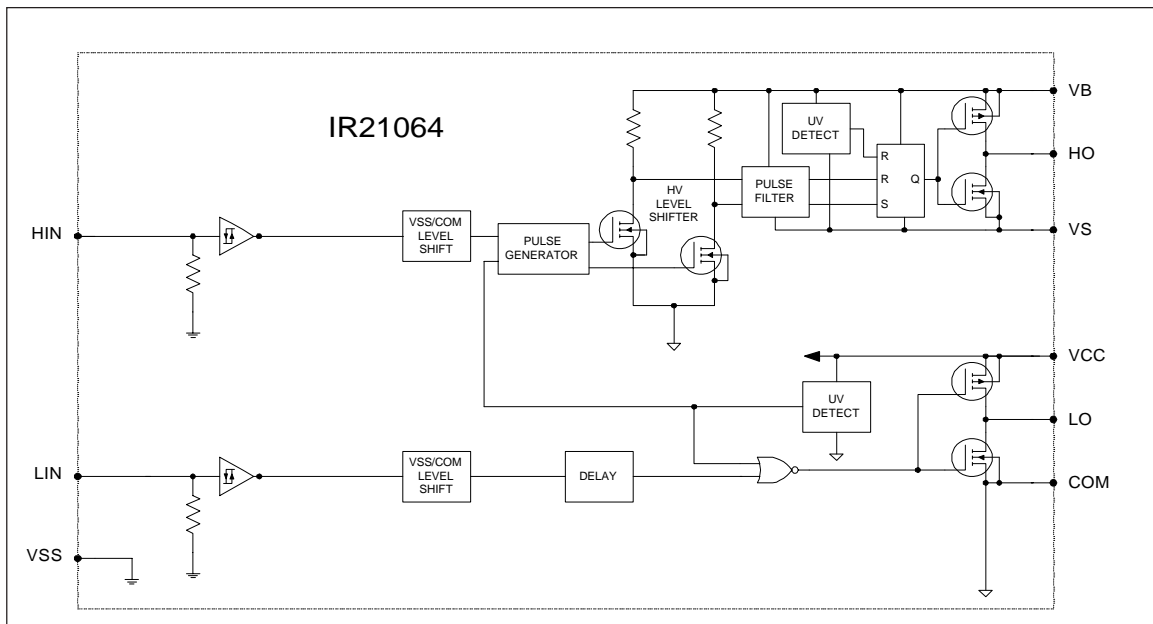
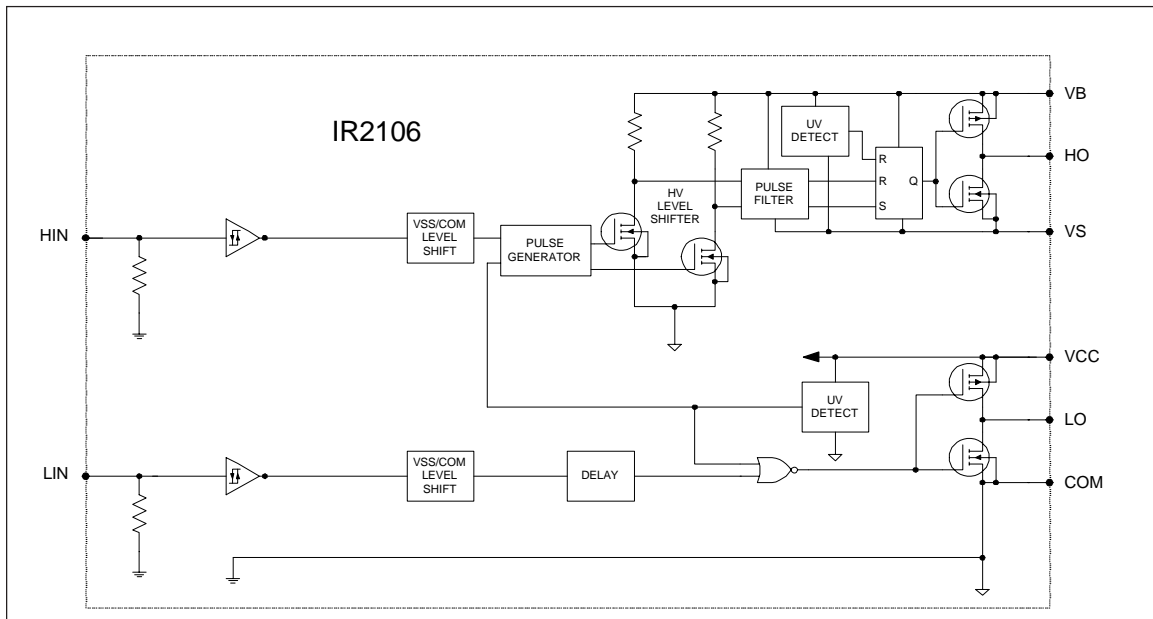
# IR2106(4)(S) & (PBF)

## Static Electrical Characteristics

$V_{BIAS}$  ( $V_{CC}$ ,  $V_{BS}$ ) = 15V,  $V_{SS}$  = COM and  $T_A$  = 25°C unless otherwise specified. The  $V_{IL}$ ,  $V_{IH}$  and  $I_{IN}$  parameters are referenced to  $V_{SS}/COM$  and are applicable to the respective input leads. The  $V_O$ ,  $I_O$  and  $R_{on}$  parameters are referenced to COM and are applicable to the respective output leads: HO and LO.

Symbol	Definition	Min.	Typ.	Max.	Units	Test Conditions
$V_{IH}$	Logic "1" input voltage (IR2106(4))	2.9	—	—	V	$V_{CC} = 10V$ to 20V
$V_{IL}$	Logic "0" input voltage (IR2106(4))	—	—	0.8		$V_{CC} = 10V$ to 20V
$V_{OH}$	High level output voltage, $V_{BIAS} - V_O$	—	0.8	1.4		$I_O = 20$ mA
$V_{OL}$	Low level output voltage, $V_O$	—	0.3	0.6		$I_O = 20$ mA
$I_{LK}$	Offset supply leakage current	—	—	50	$\mu A$	$V_B = V_S = 600V$
$I_{QBS}$	Quiescent $V_{BS}$ supply current	20	75	130		$V_{IN} = 0V$ or 5V
$I_{QCC}$	Quiescent $V_{CC}$ supply current	60	120	180		$V_{IN} = 0V$ or 5V
$I_{IN+}$	Logic "1" input bias current $V_{IN} = 5V$ (IR2106(4))	—	5	20		
$I_{IN-}$	Logic "0" input bias current $V_{IN} = 0V$ (IR2106(4))	—	—	2		
$V_{CCUV+}$ $V_{BSUV+}$	$V_{CC}$ and $V_{BS}$ supply undervoltage positive going threshold	8.0	8.9	9.8	V	
$V_{CCUV-}$ $V_{BSUV-}$	$V_{CC}$ and $V_{BS}$ supply undervoltage negative going threshold	7.4	8.2	9.0		
$V_{CCUVH}$ $V_{BSUVH}$	Hysteresis	0.3	0.7	—		
$I_{O+}$	Output high short circuit pulsed current	120	200	—	mA	$V_O = 0V$ , $PW \leq 10 \mu s$
$I_{O-}$	Output low short circuit pulsed current	250	350	—		$V_O = 15V$ , $PW \leq 10 \mu s$

**Functional Block Diagrams**

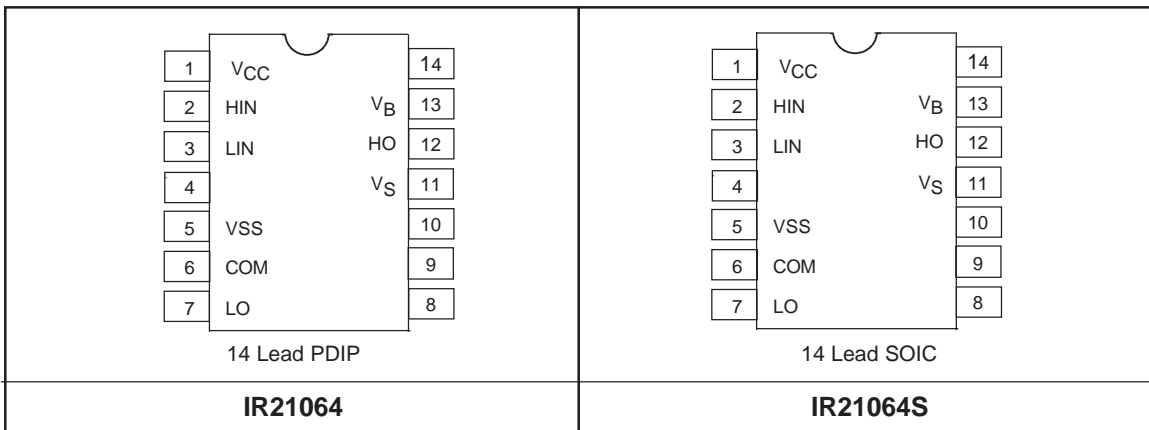
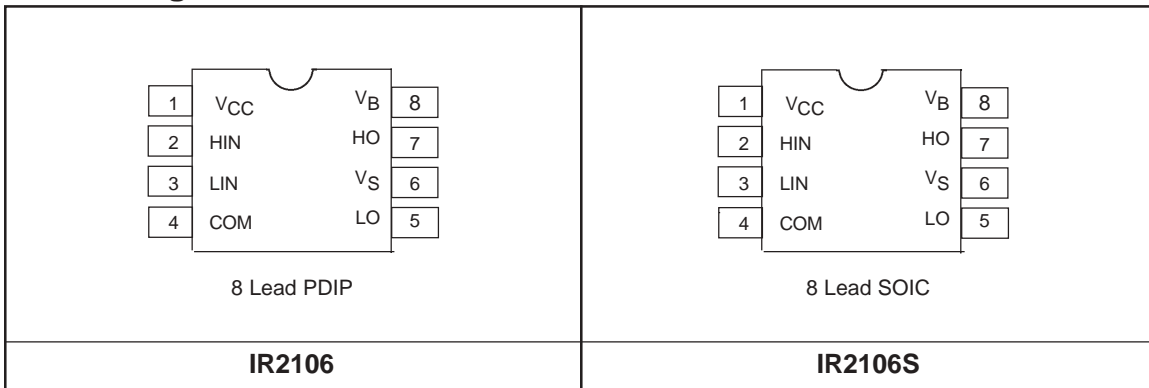


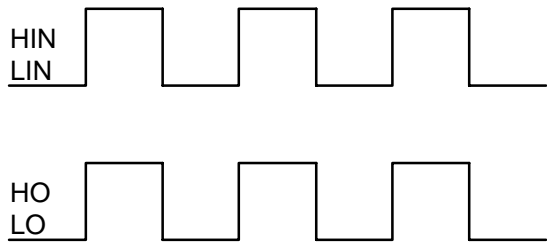
# IR2106(4)(S) & (PBF)

## Lead Definitions

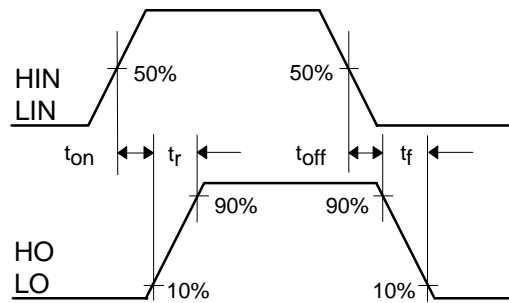
Symbol	Description
HIN	Logic input for high side gate driver output (HO), in phase
LIN	Logic input for low side gate driver output (LO), in phase
VSS	Logic Ground (IR21064 only)
V <sub>B</sub>	High side floating supply
HO	High side gate drive output
V <sub>S</sub>	High side floating supply return
V <sub>CC</sub>	Low side and logic fixed supply
LO	Low side gate drive output
COM	Low side return

## Lead Assignments

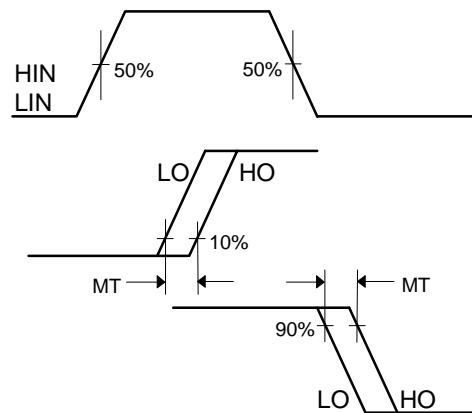




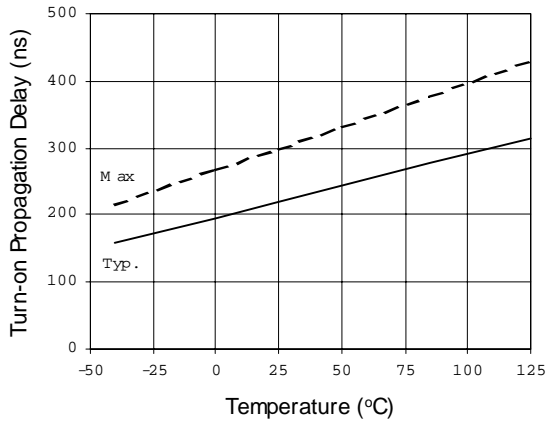
**Figure 1. Input/Output Timing Diagram**



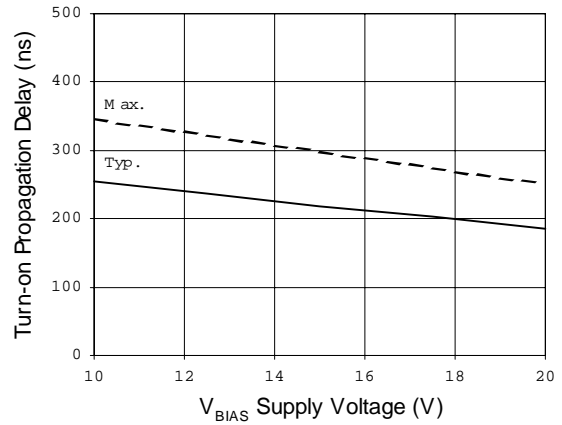
**Figure 2. Switching Time Waveform Definitions**



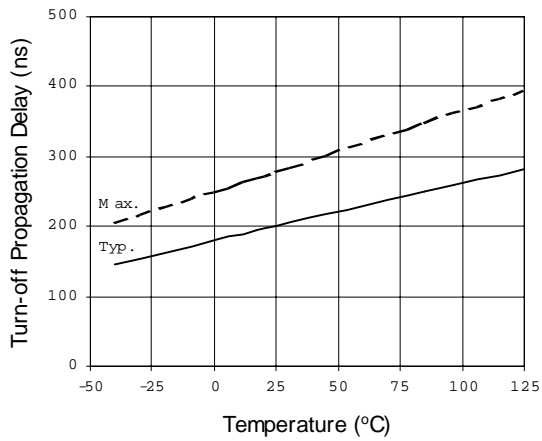
**Figure 3. Delay Matching Waveform Definitions**



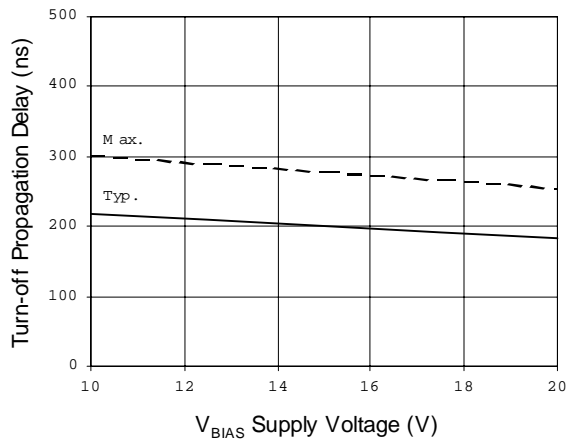
**Figure 4A. Turn-on Propagation Delay vs. Temperature**



**Figure 4B. Turn-on Propagation Delay vs. Supply Voltage**



**Figure 5A. Turn-off Propagation Delay vs. Temperature**



**Figure 5B. Turn-off Propagation Delay vs. Supply Voltage**



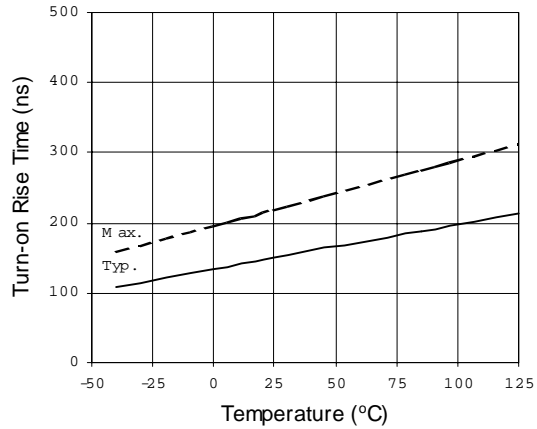


Figure 6A. Turn-on Rise Time vs. Temperature

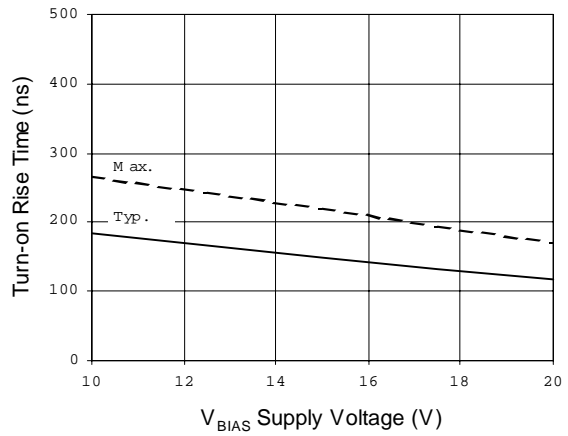


Figure 6B. Turn-on Rise Time vs. Supply Voltage

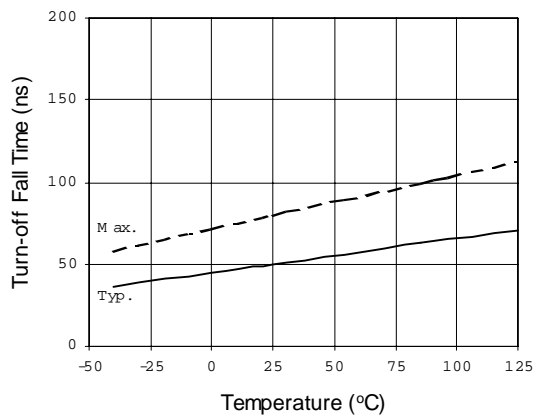


Figure 7A. Turn-off Fall Time vs. Temperature

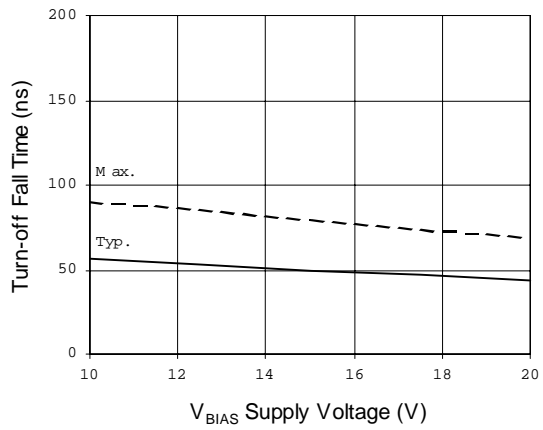
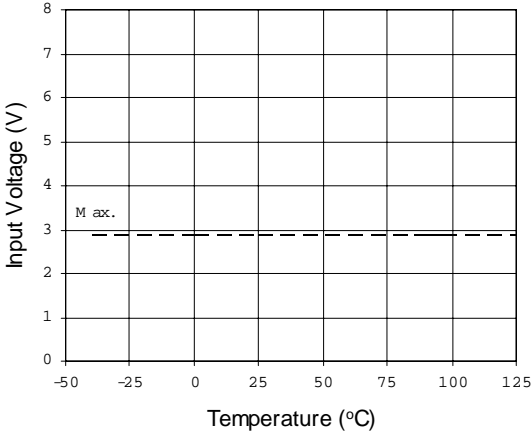
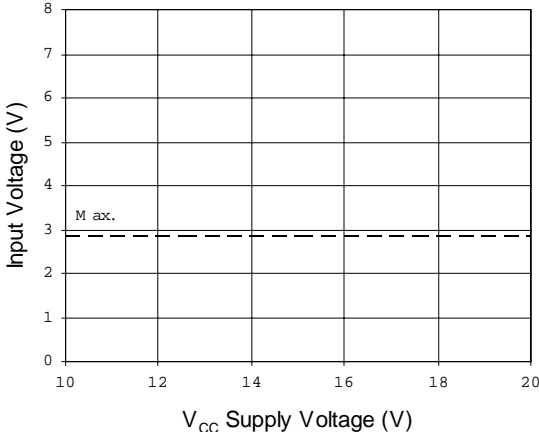


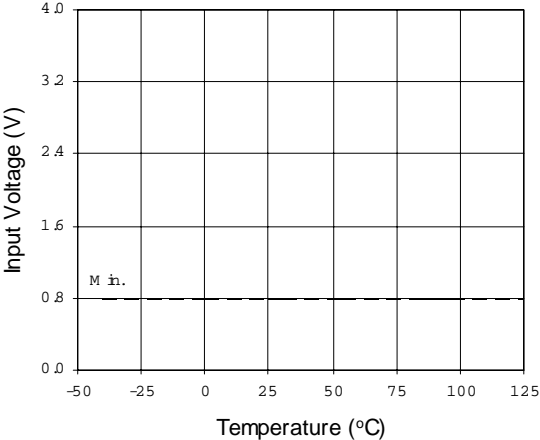
Figure 7B. Turn-off Fall Time vs. Supply Voltage



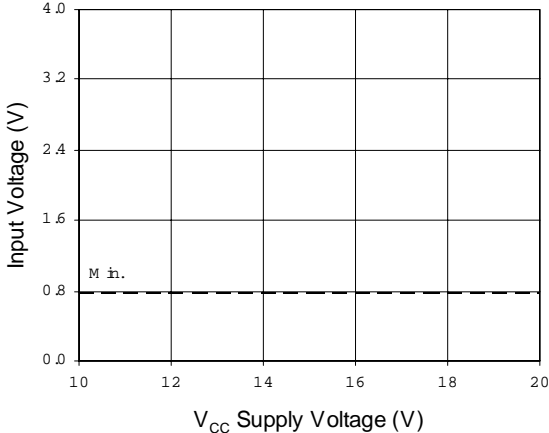
**Figure 8A. Logic "1" Input Voltage vs. Temperature**



**Figure 8B. Logic "1" Input Voltage vs. Supply Voltage**



**Figure 9A. Logic "0" Input Voltage vs. Temperature**



**Figure 9B. Logic "0" Input Voltage vs. Supply Voltage**

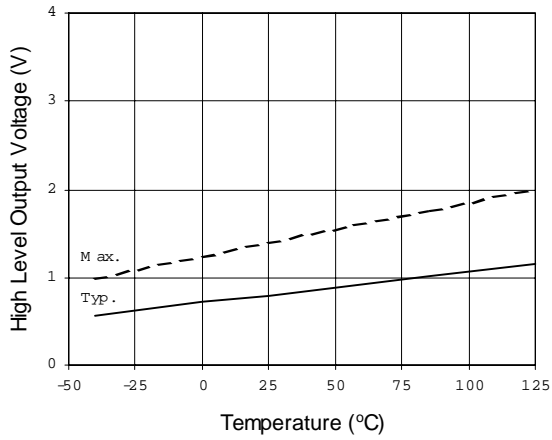


Figure 10A. High Level Output Voltage vs. Temperature

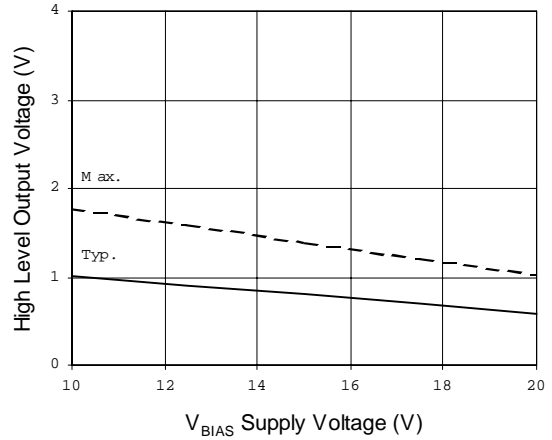


Figure 10B. High Level Output Voltage vs. Supply Voltage

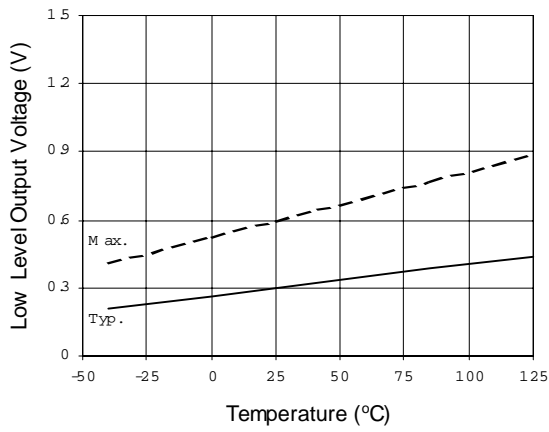


Figure 11A. Low Level Output Voltage vs. Temperature

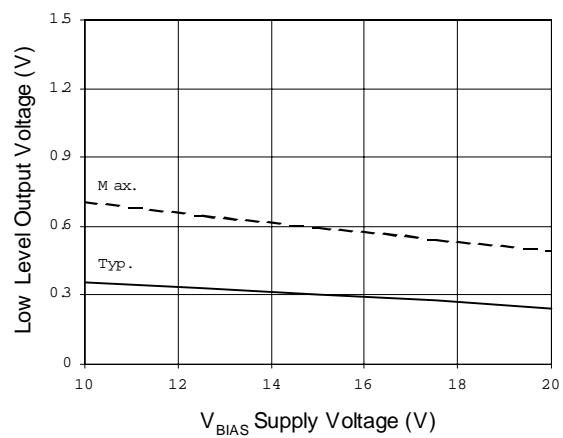
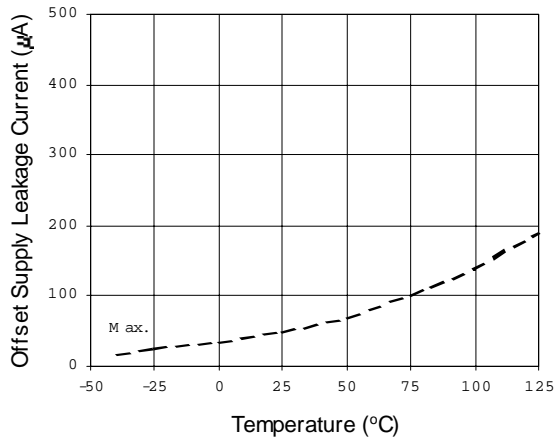
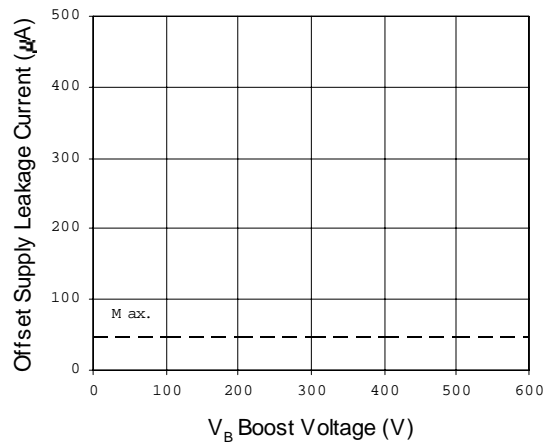


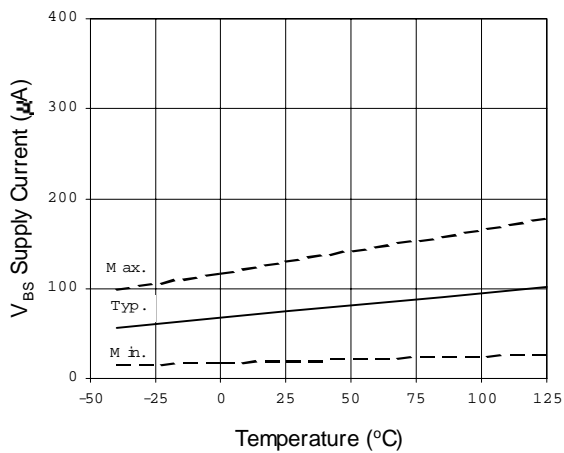
Figure 11B. Low Level Output Voltage vs. Supply Voltage



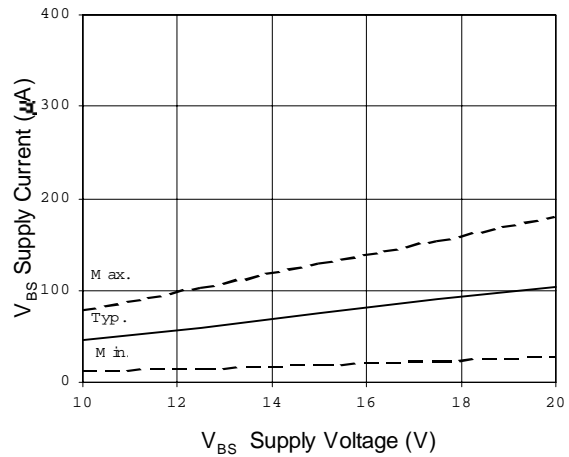
**Figure 12A. Offset Supply Leakage Current vs. Temperature**



**Figure 12B. Offset Supply Leakage Current vs. Supply Voltage**



**Figure 13A. V<sub>BS</sub> Supply Current vs. Temperature**



**Figure 13B. V<sub>BS</sub> Supply Current vs. Supply Voltage**

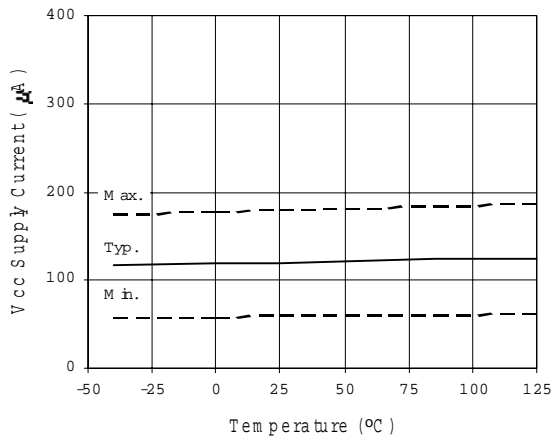


Figure 14A. Quiescent VCC Supply Current vs. Temperature

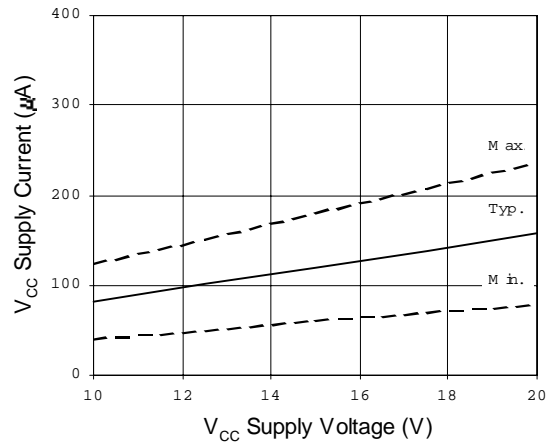


Figure 14B. Quiescent VCC Supply Current vs. VCC Supply Voltage

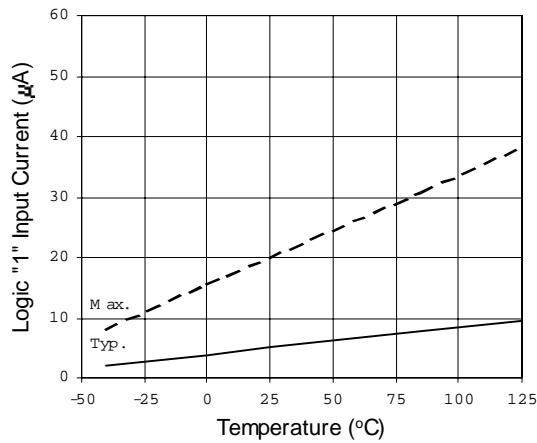


Figure 15A. Logic "1" Input Current vs. Temperature

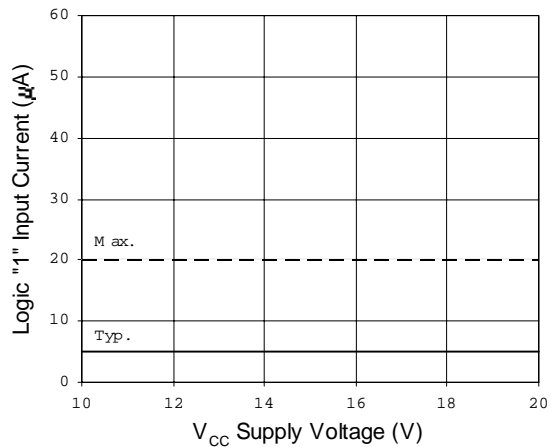
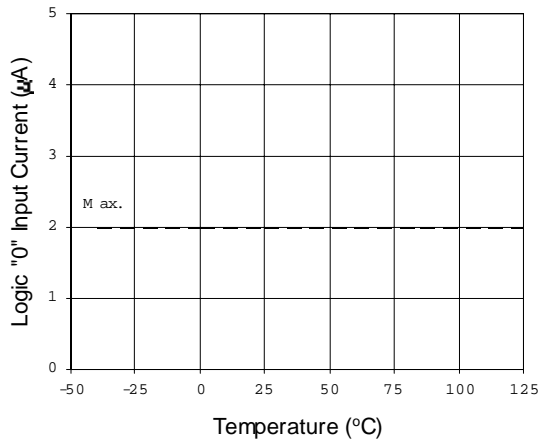
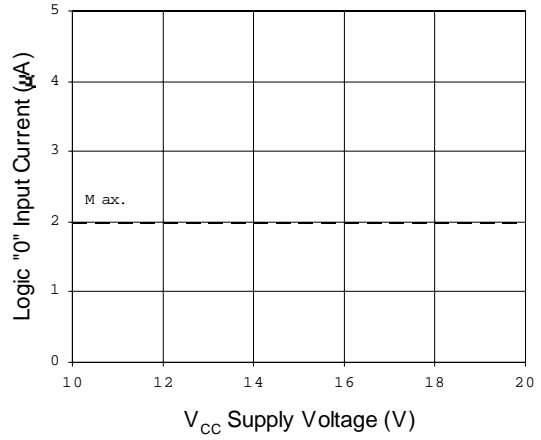


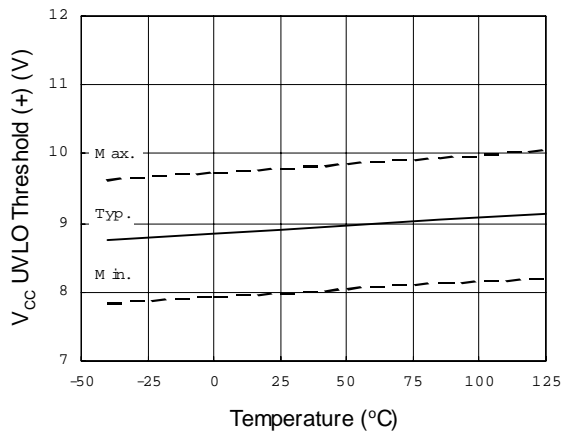
Figure 15B. Logic "1" Bias Current vs. Supply Voltage



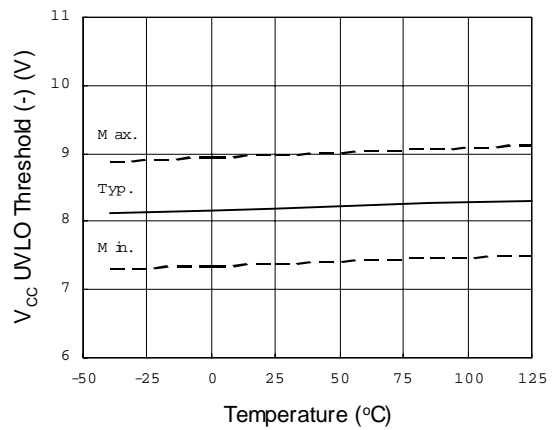
**Figure 16A. Logic "0" Input Current vs. Temperature**



**Figure 16B. Logic "0" Input Current vs. Supply Voltage**



**Figure 17. V<sub>CC</sub> Undervoltage Threshold (+) vs. Temperature**



**Figure 18. V<sub>CC</sub> Undervoltage Threshold (-) vs. Temperature**

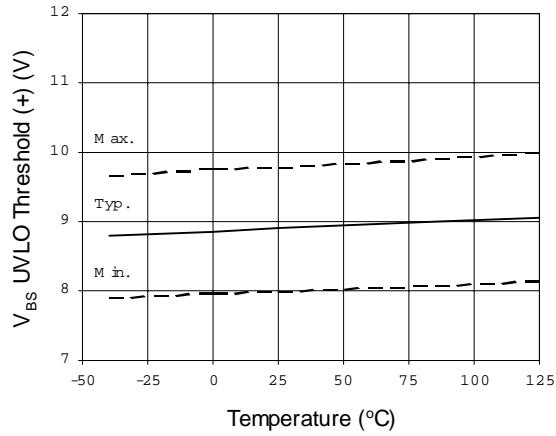


Figure 19.  $V_{BS}$  Undervoltage Threshold (+) vs. Temperature

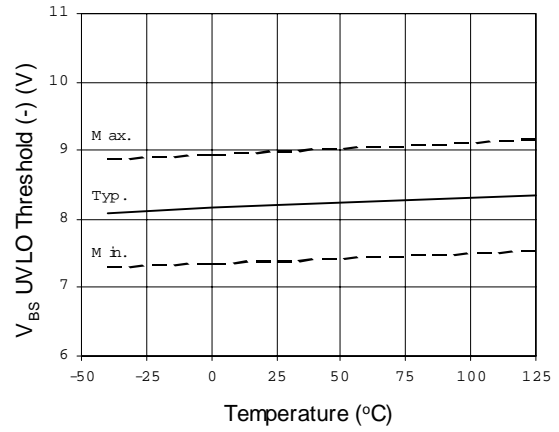


Figure 20.  $V_{BS}$  Undervoltage Threshold (-) vs. Temperature

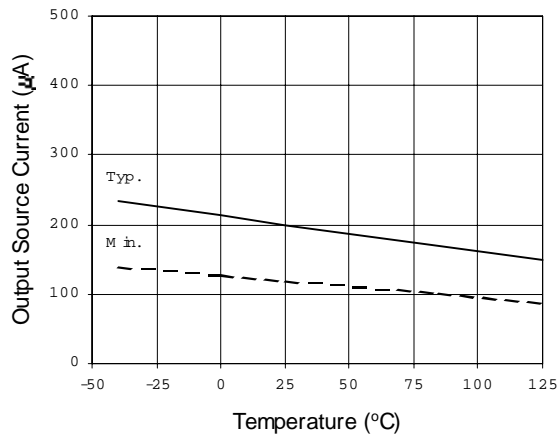


Figure 21A. Output Source Current vs. Temperature

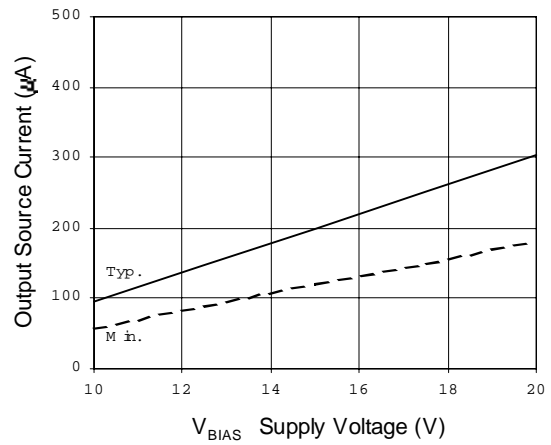
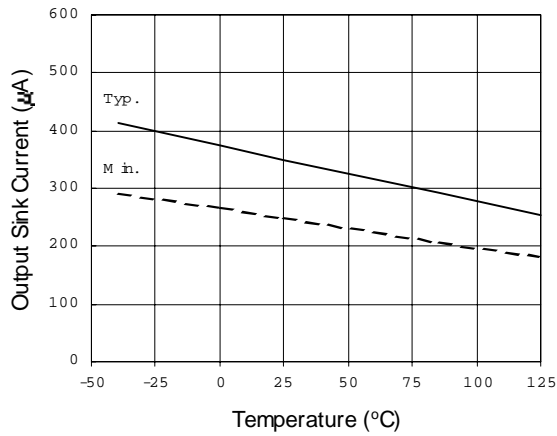
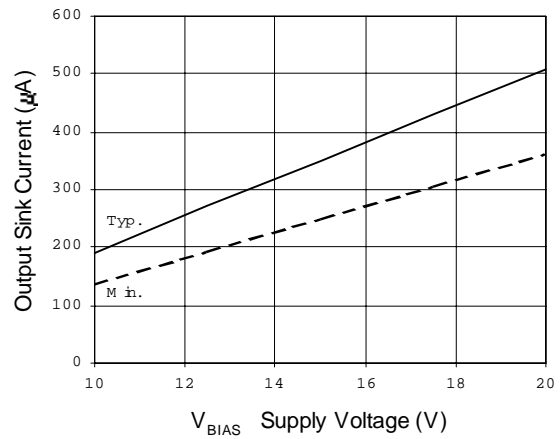


Figure 21B. Output Source Current vs. Supply Voltage

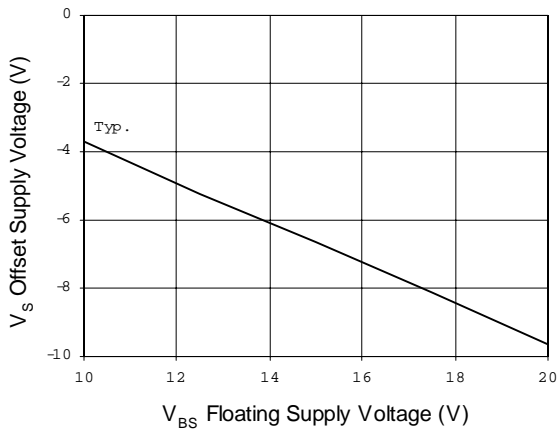
# IR2106(4)(S) & (PBF)



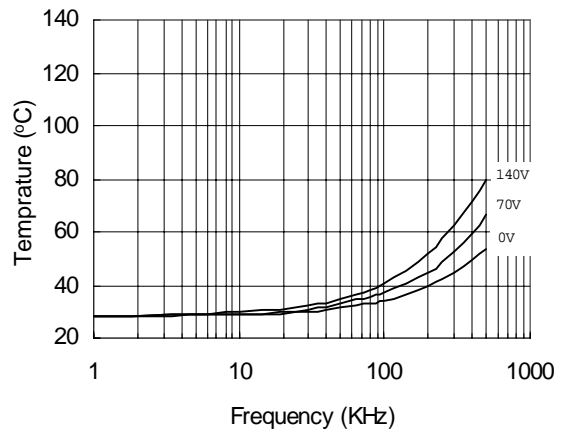
**Figure 22A. Output Sink Current vs. Temperature**



**Figure 22B. Output Sink Current vs. Supply Voltage**



**Figure 23. Maximum V<sub>S</sub> Negative Offset vs. Supply Voltage**



**Figure 24. IR2106 vs. Frequency (IRFBC20), R<sub>gate</sub>=33Ω, V<sub>CC</sub>=15V**



# IR2106(4)(S & (PbF))

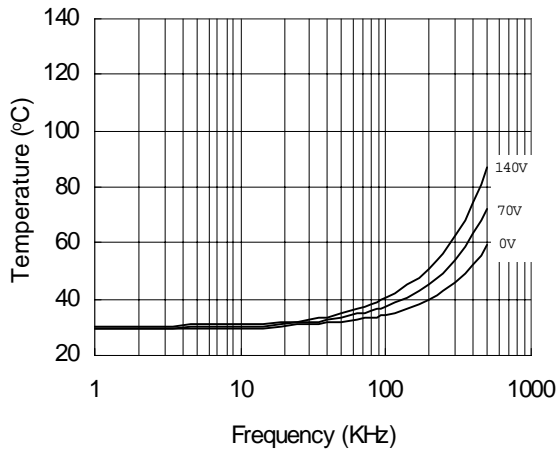


Figure 25. IR2106 vs. Frequency (IRFBC30),  
 $R_{gate}=22\Omega$ ,  $V_{CC}=15V$

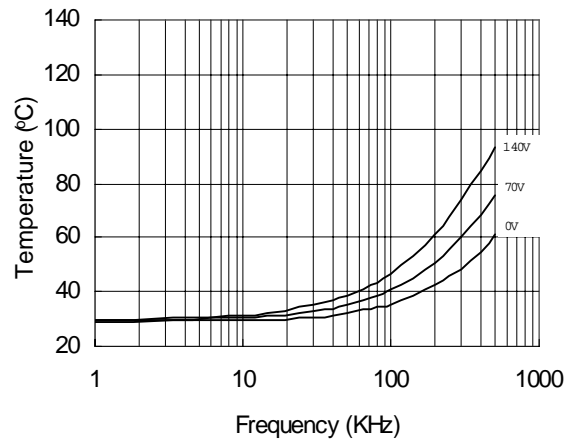


Figure 26. IR2106 vs. Frequency (IRFBC40),  
 $R_{gate}=15\Omega$ ,  $V_{CC}=15V$

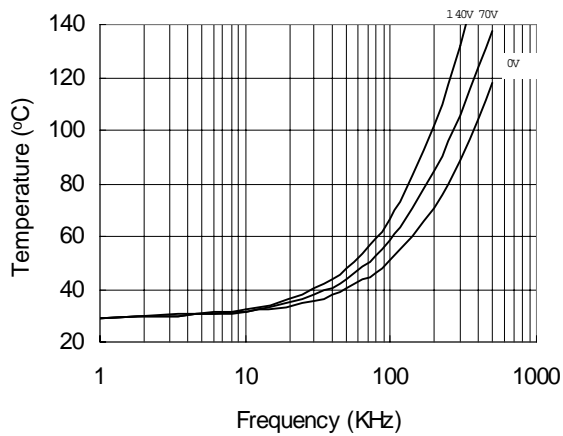


Figure 27. IR2106 vs. Frequency (IRFPE50),  
 $R_{gate}=10\Omega$ ,  $V_{CC}=15V$

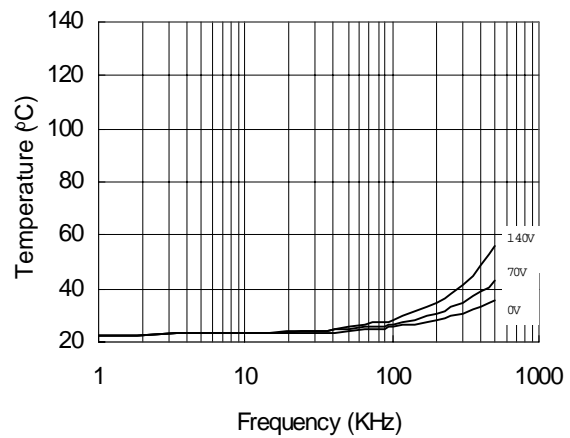


Figure 28. IR21064 vs. Frequency (IRFBC20),  
 $R_{gate}=33\Omega$ ,  $V_{CC}=15V$

# IR2106(4)(S) & (PBF)

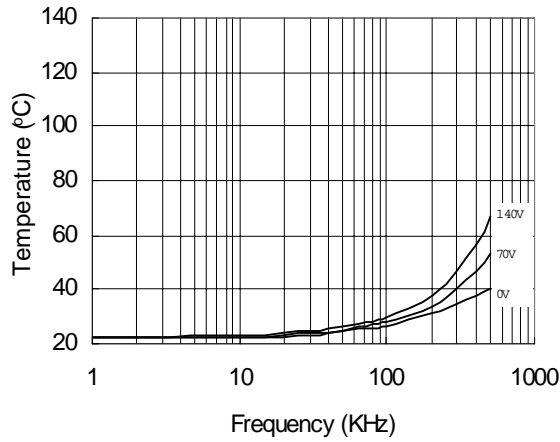


Figure 29. IR21064 vs. Frequency (IRFBC30),  
 $R_{gate}=22\Omega$ ,  $V_{CC}=15V$

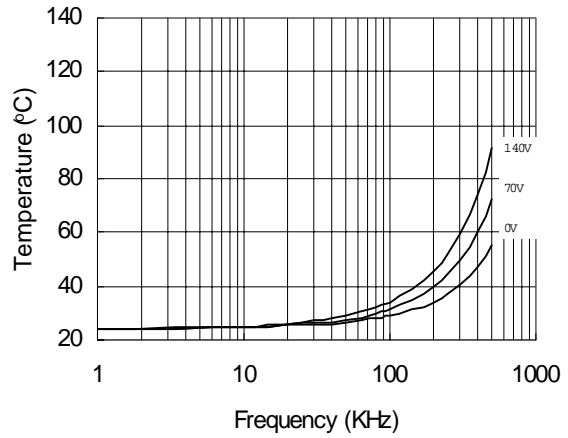


Figure 30. IR21064 vs. Frequency (IRFBC40),  
 $R_{gate}=15\Omega$ ,  $V_{CC}=15V$

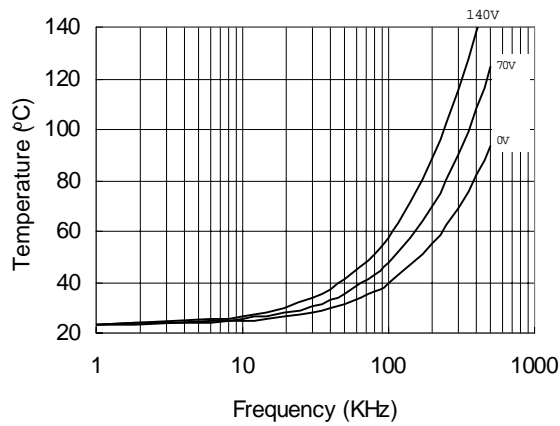


Figure 31. IR21064 vs. Frequency (IRFPE50),  
 $R_{gate}=10\Omega$ ,  $V_{CC}=15V$

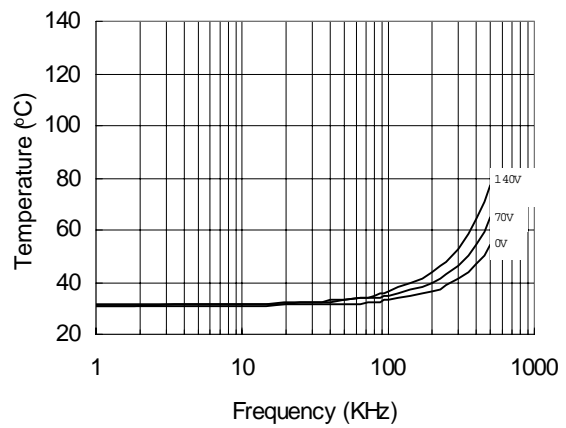
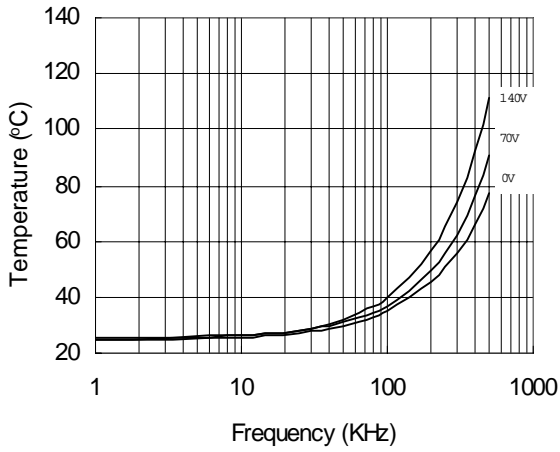
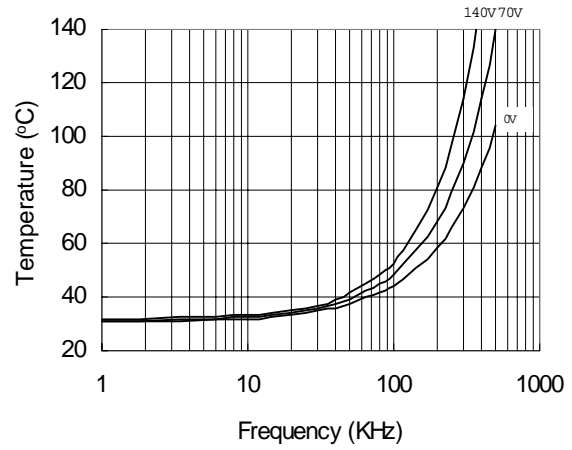


Figure 32. IR2106S vs. Frequency (IRFBC20),  
 $R_{gate}=33\Omega$ ,  $V_{CC}=15V$

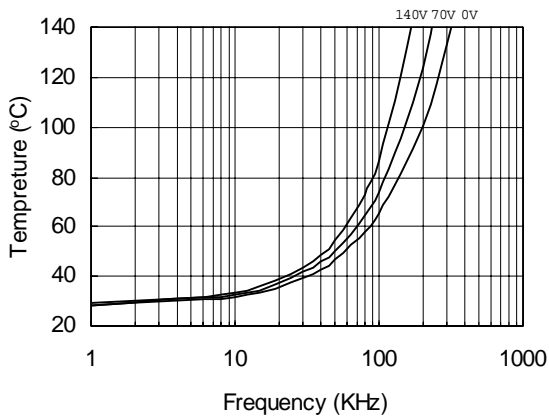
# IR2106(4)(S & (PbF))



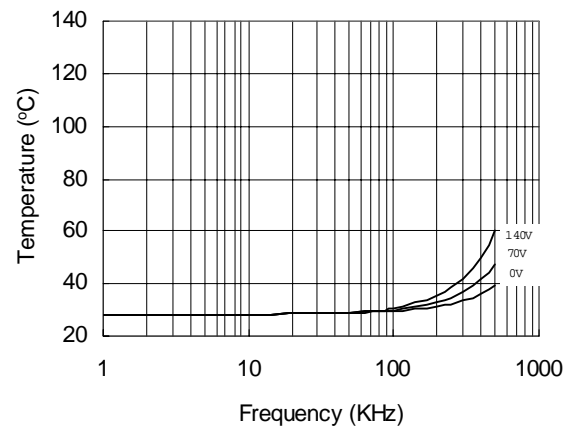
**Figure 33. IR2106S vs. Frequency (IRFBC30),  
 $R_{gate}=22\Omega$ ,  $V_{cc}=15V$**



**Figure 34. IR2106S vs. Frequency (IRFBC40),  
 $R_{gate}=15\Omega$ ,  $V_{cc}=15V$**



**Figure 35. IR2106S vs. Frequency  
(IRFPE50),  $R_{gate}=10\Omega$ ,  $V_{cc}=15V$**



**Figure 36. IR21064S vs. Frequency (IRFBC20),  
 $R_{gate}=33\Omega$ ,  $V_{cc}=15V$**

# IR2106(4)(S) & (PBF)

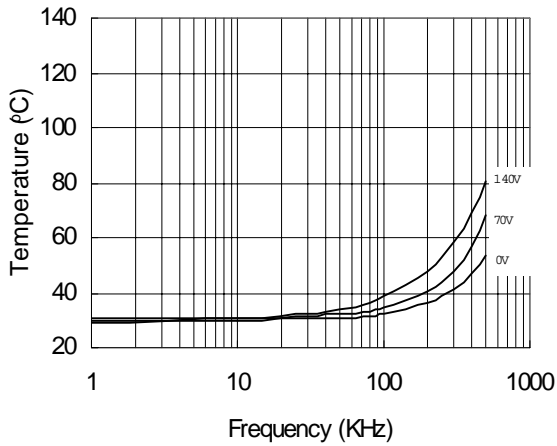


Figure 37. IR21064S vs. Frequency (IRFBC30),  
 $R_{gate}=22\Omega$ ,  $V_{CC}=15V$

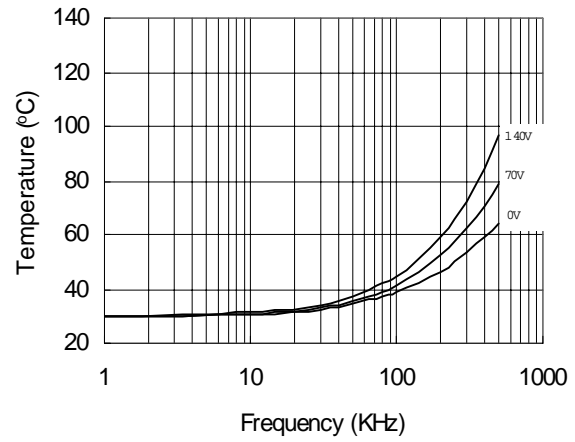


Figure 38. IR21064S vs. Frequency (IRFBC40),  
 $R_{gate}=15\Omega$ ,  $V_{CC}=15V$

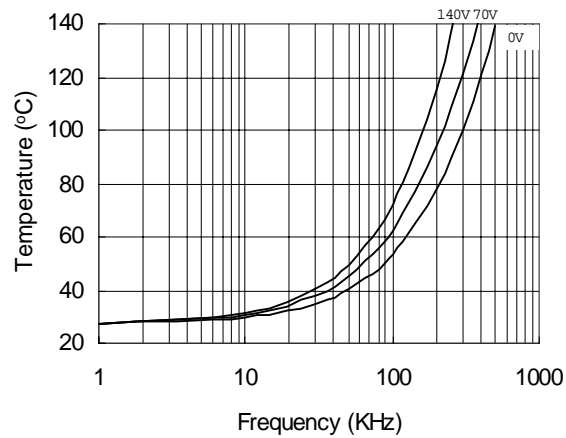
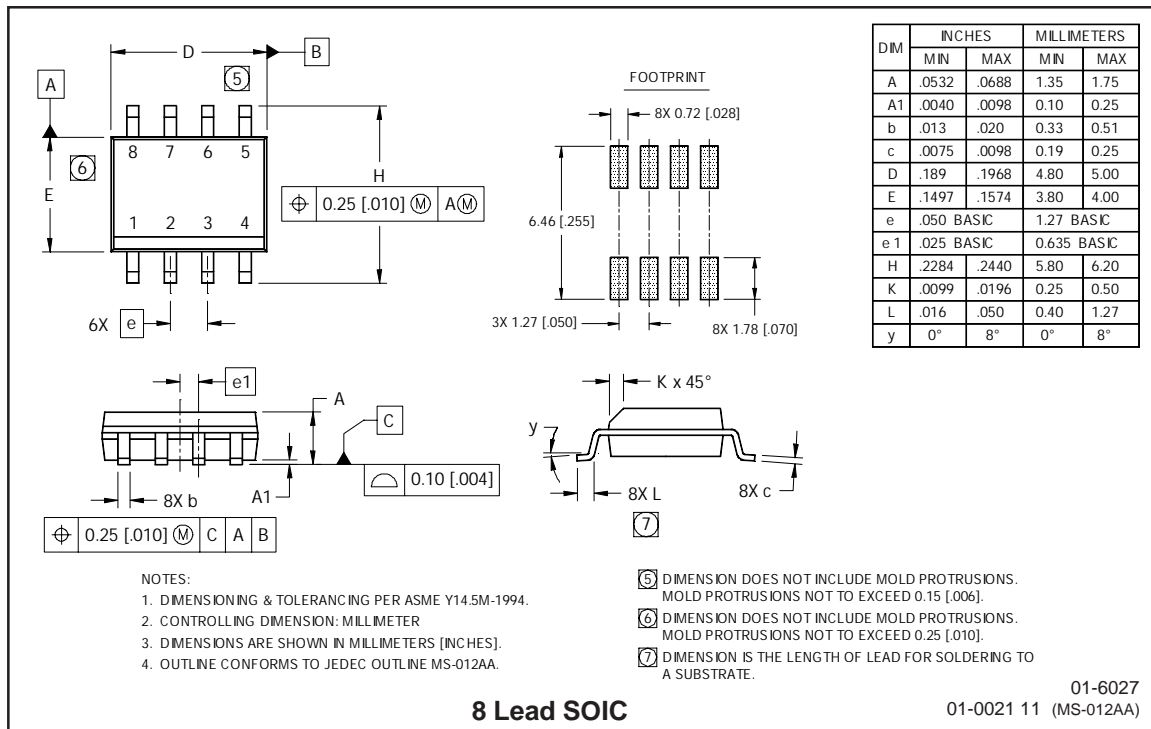
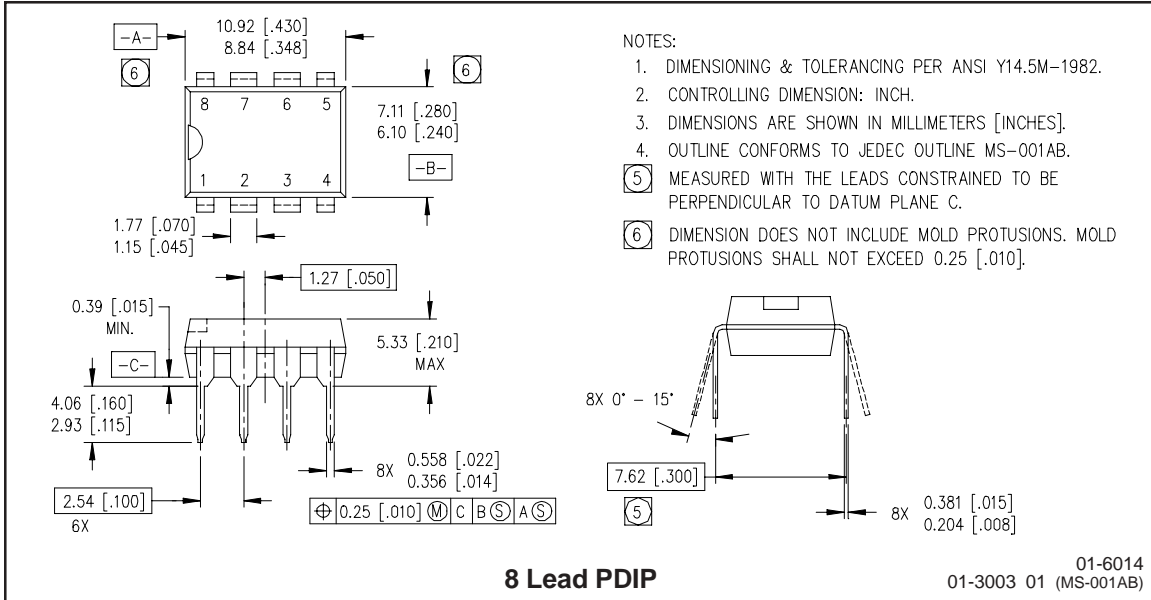


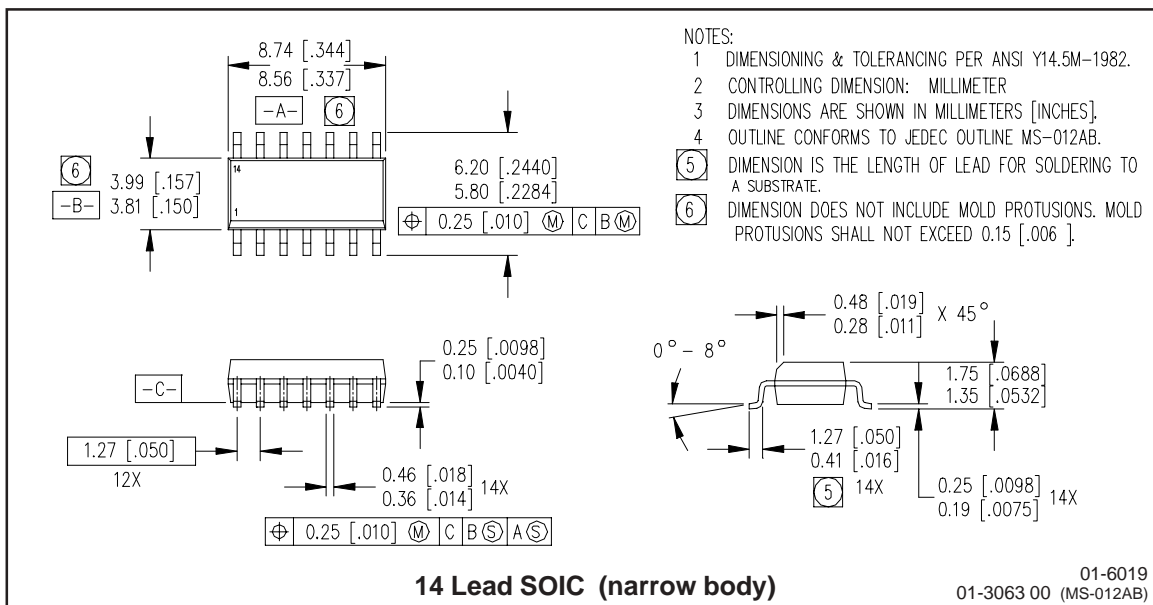
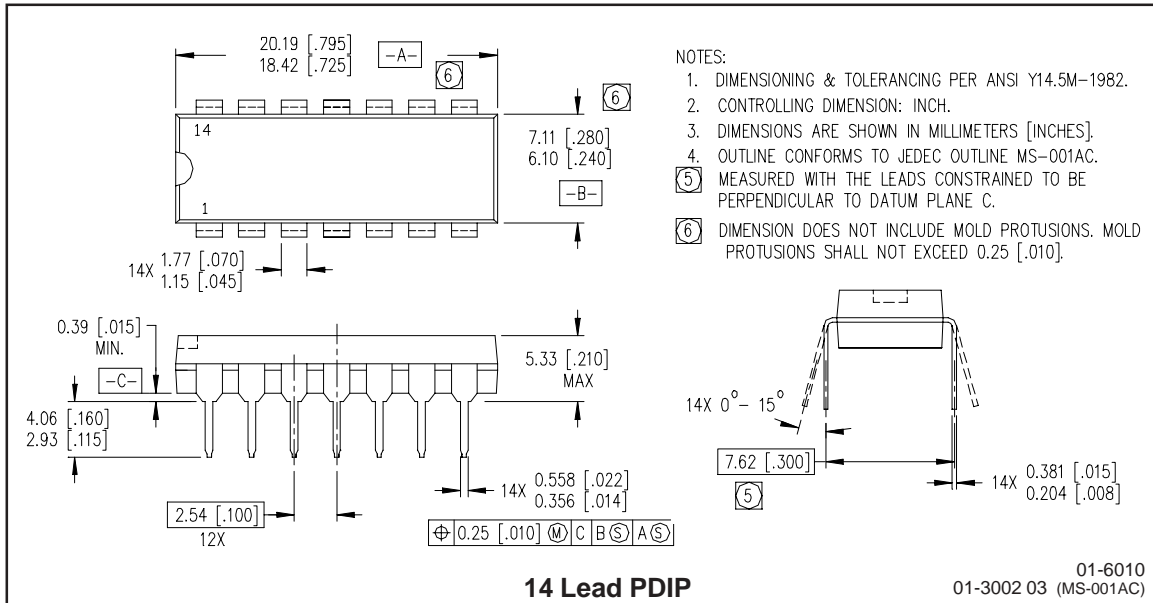
Figure 39. IR21064S vs. Frequency (IRFPE50),  
 $R_{gate}=10\Omega$ ,  $V_{CC}=15V$

## Case Outlines

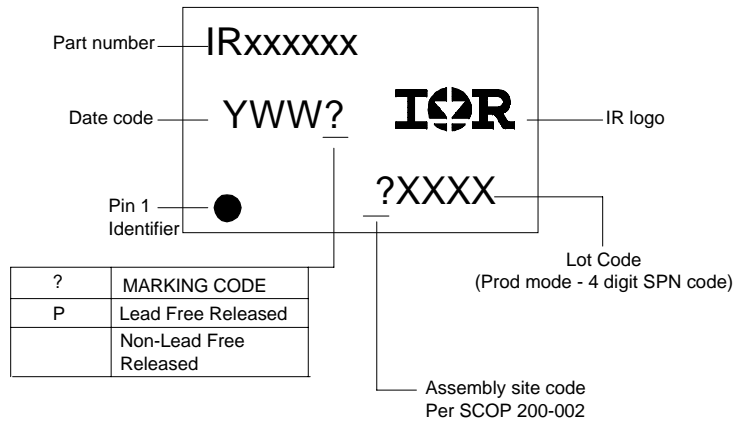


# IR2106(4)(S) & (PBF)

International  
IR Rectifier



## LEADFREE PART MARKING INFORMATION



## ORDER INFORMATION

### Basic Part (Non-Lead Free)

8-Lead PDIP IR2106 order IR2106  
 8-Lead SOIC IR2106S order IR2106S  
 14-Lead PDIP IR21064 order IR21064  
 14-Lead SOIC IR21064S order IR21064S

### Leadfree Part

8-Lead PDIP IR2106 order IR2106PbF  
 8-Lead SOIC IR2106S order IR2106SPbF  
 14-Lead PDIP IR21064 order IR21064PbF  
 14-Lead SOIC IR21064S order IR21064SPbF



Компания «ЭлектроПласт» предлагает заключение долгосрочных отношений при поставках импортных электронных компонентов на взаимовыгодных условиях!

Наши преимущества:

- Оперативные поставки широкого спектра электронных компонентов отечественного и импортного производства напрямую от производителей и с крупнейших мировых складов;
- Поставка более 17-ти миллионов наименований электронных компонентов;
- Поставка сложных, дефицитных, либо снятых с производства позиций;
- Оперативные сроки поставки под заказ (от 5 рабочих дней);
- Экспресс доставка в любую точку России;
- Техническая поддержка проекта, помощь в подборе аналогов, поставка прототипов;
- Система менеджмента качества сертифицирована по Международному стандарту ISO 9001;
- Лицензия ФСБ на осуществление работ с использованием сведений, составляющих государственную тайну;
- Поставка специализированных компонентов (Xilinx, Altera, Analog Devices, Intersil, Interpoint, Microsemi, Aeroflex, Peregrine, Syfer, Eurofarad, Texas Instrument, Miteq, Cobham, E2V, MA-COM, Hittite, Mini-Circuits, General Dynamics и др.);

Помимо этого, одним из направлений компании «ЭлектроПласт» является направление «Источники питания». Мы предлагаем Вам помощь Конструкторского отдела:

- Подбор оптимального решения, техническое обоснование при выборе компонента;
- Подбор аналогов;
- Консультации по применению компонента;
- Поставка образцов и прототипов;
- Техническая поддержка проекта;
- Защита от снятия компонента с производства.



#### Как с нами связаться

**Телефон:** 8 (812) 309 58 32 (многоканальный)

**Факс:** 8 (812) 320-02-42

**Электронная почта:** [org@eplast1.ru](mailto:org@eplast1.ru)

**Адрес:** 198099, г. Санкт-Петербург, ул. Калинина, дом 2, корпус 4, литера А.