

ISL9305H

3MHz Dual 1.5A Step-Down Converters and Dual Low-Input LDOs with I<sup>2</sup>C Compatible Interface

FN7724  
Rev 2.00  
March 7, 2014

The ISL9305H is an integrated mini Power Management IC (mini-PMIC) for powering low-voltage microprocessors, or applications using a single Li-Ion or Li-Polymer cell battery to power multiple voltage rails. The ISL9305H integrates two high-efficiency 3MHz synchronous step-down converters (DCD1 and DCD2) and two low-input, low-dropout linear regulators (LDO1 and LDO2).

The 3MHz PWM switching frequency allows the use of very small external inductors and capacitors. Both step-down converters can enter skip mode under light load conditions to further improve the efficiency and maximize the battery life. For noise sensitive applications, they can also be programmed through I<sup>2</sup>C interface to operate in forced PWM mode regardless of the load current condition. The I<sup>2</sup>C interface supports on-the-fly slew rate control of the output voltage from 0.825V to 3.6V at 25mV/step size for dynamic power saving. Each step-down converter can supply up to 1.5A load current. The default output voltage can be set from 0.8V to V<sub>IN</sub> using external feedback resistors on the adjustable version, or the ISL9305H can be ordered in factory pre-set voltage options from 0.9V to 3.6V in 50mV step.

The ISL9305H also provides two 300mA low dropout (LDO) regulators. The input voltage range is 1.5V to 5.5V allowing them to be powered from one of the on-chip step-down converters or directly from the battery. The default LDO output comes with factory pre-set fixed output voltage options between 0.9V to 3.3V.

The ISL9305H is available in a 4mmx4mm 16 Ld TQFN package.

**Related Literature**

- [FN7605](#), ISL9305 Data Sheet
- [AN1564](#) "ISL9305 and ISL9305H Evaluation Boards"

**Features**

- Dual 1.5A, Synchronous Step-down Converters and Dual 300mA, General-purpose LDOs
- Input Voltage Range
  - DCD1/DCD2 ..... 2.5V to 5.5V
  - LDO1/LDO2 ..... 1.5V to 5.5V
- 400kb/s I<sup>2</sup>C-Bus Series Interface Transfers the Control Data Between the Host Controller and the ISL9305H
- Adjustable Output Voltage
  - VODCD1/VODCD2 ..... 0.8V to V<sub>IN</sub>
- Fixed Output I<sup>2</sup>C Programmability
  - At 25mV/Step ..... 0.825V to 3.6V
- LDO1/LDO2 Output Voltage I<sup>2</sup>C Programmability
  - At 50mV/Step ..... 0.9V to 3.6V
- 50µA I<sub>Q</sub> (Typ) with DCD1/DCD2 in Skip Mode; 20µA I<sub>Q</sub> (Typ) for Each Enabled LDO
- On-the-fly I<sup>2</sup>C Programming of DC/DC and LDO Output Voltages
- DCD1/DCD2 I<sup>2</sup>C Programmable Skip Mode Under Light Load or Forced Fixed Switching Frequency PWM Mode
- Small, Thin 4mmx4mm TQFN Package

**Applications**

- Cellular Phones, Smart Phones
- PDAs, Portable Media Players, Portable Instruments
- Single Li-Ion/Li-Polymer Battery-Powered Equipment
- DSP Core Power



\*Only for adjustable output version. For fixed output version, directly connect the FB pin to the output of the buck converter.

FIGURE 1. TYPICAL APPLICATION DIAGRAM

TABLE 1. TYPICAL APPLICATION PARTS LIST

PARTS	DESCRIPTION	MANUFACTURER	PART NUMBER	SPECIFICATIONS	SIZE
L1, L2	Inductor	Sumida	CDRH2D14NP-1R5	1.5μH/1.80A/50mΩ	3.0mmx3.0mmx1.55mm
C1	Input capacitor	Murata	GRM21BR60J106KE19L	10μF/6.3V	0805
C2, C3	Input capacitor	Murata	GRM185R60J105KE26D	1μF/6.3V	0603
C4, C5	Output capacitor	Murata	GRM21BR71A106KE51L	10μF/6.3V	0805
C6, C7	Output capacitor	Murata	GRM185R60J105KE26D	1μF/6.3V	0603
R1, R2, R3, R4	Resistor	Various		1%, SMD, 0.1W	0603

## Pin Configuration



## Pin Descriptions

PIN NUMBER (TQFN)	NAME	DESCRIPTION
1	VINDCD1	Input voltage for buck converter DCD1 and it also serves as the power supply pin for the whole internal digital/analog circuits.
2	FB1	Feedback pin for DCD1, connect external voltage divider resistors between DCD1 output, this pin and ground. For fixed output versions, connect this pin directly to the DCD1 output.
3	SCLK	I <sup>2</sup> C interface clock pin.
4	SDAT	I <sup>2</sup> C interface data pin.
5	VINLD01	Input voltage for LD01.
6	VOLDO1	Output voltage of LD01.
7	VOLDO2	Output voltage of LD02.
8	VINLD02	Input voltage for LD02.
9	GNLDLO	Power ground for LD01 and LD02.
10	DCDPG	The DCDPG pin is an open-drain output to indicate the state of the DCD1/DCD2 output voltages. When both DCD1 and DCD2 are enabled, the output is released to be pulled high by an external pull-up resistor if both converter voltages are within the power good range. The pin will be pulled low if either DCD is outside their range. When only one DCD is enabled, the state of the enabled DCD's output will define the state of the DCDPG pin. The DCDPG state can be programmed for a delay of up to 200ms before being released to rise high. The programming range is 1ms~200ms through the I <sup>2</sup> C interface.

## Pin Descriptions (Continued)

PIN NUMBER (TQFN)	NAME	DESCRIPTION
11	FB2	Feedback pin for DCD2, connect external voltage divider resistors between DCD2 output, this pin and ground. For fixed output versions, connect this pin directly to the DCD2 output.
12	VINDCD2	Input voltage for buck converter DCD2.
13	SW2	Switching node for DCD2, connect to one terminal of the inductor.
14	GNDDCD2	Power ground for DCD2.
15	GNDDCD1	Power ground for DCD1.
16	SW1	Switching node for DCD1, connect to one terminal of the inductor.
E-PAD	E-PAD	Exposed Pad. Connect to system ground.

## Block Diagram



## Ordering Information

PART NUMBER (Notes 1, 2, 3)	PART MARKING	FBSEL DCD1 (V)	FBSEL DCD2 (V)	SLV LD01 (V)	SLV LD02 (V)	TEMP. RANGE (°C)	PACKAGE Tape & Reel (Pb-free)	PKG. DWG. #
ISL9305IRTHAANLZ-T	9305I HAANLZ	Adj	Adj	3.3	2.9	-40 to +85	16 Ld TQFN	L16.4x4G
ISL9305IRTHWBNLZ-T	9305I HWBNLZ	1.2	1.5	3.3	2.9	-40 to +85	16 Ld TQFN	L16.4x4G
ISL9305IRTHWCLBZ-T	9305I HWCLBZ	1.2	1.8	2.9	1.5	-40 to +85	16 Ld TQFN	L16.4x4G
ISL9305IRTHWCNYZ-T	9305I HWCNYZ	1.2	1.8	3.3	0.9	-40 to +85	16 Ld TQFN	L16.4x4G
ISL9305IRTHWCNLZ-T	9305I HWCNLZ	1.2	1.8	3.3	2.9	-40 to +85	16 Ld TQFN	L16.4x4G
ISL9305IRTHWLNCZ-T	9305I HWLNCZ	1.2	2.9	3.3	1.8	-40 to +85	16 Ld TQFN	L16.4x4G
ISL9305IRTHBCNLZ-T	9305I HBCNLZ	1.5	1.8	3.3	2.9	-40 to +85	16 Ld TQFN	L16.4x4G
ISL9305IRTHBFNCZ-T	9305I HBFNCZ	1.5	2.5	3.3	1.8	-40 to +85	16 Ld TQFN	L16.4x4G
ISL9305IRTHAANLZE1Z	Evaluation Board for ISL9305IRTHAANLZ							
ISL9305IRTHBCNLZE1Z	Evaluation Board for ISL9305IRTHBCNLZ							
ISL9305IRTHBFNCZE1Z	Evaluation Board for ISL9305IRTHBFNCZ							
ISL9305IRTHWBNLZE1Z	Evaluation Board for ISL9305IRTHWBNLZ							
ISL9305IRTHWCLBZE1Z	Evaluation Board for ISL9305IRTHWCLBZ							
ISL9305IRTHWCNLZE1Z	Evaluation Board for ISL9305IRTHWCNLZ							
ISL9305IRTHWCNYZE1Z	Evaluation Board for ISL9305IRTHWCNYZ							
ISL9305IRTHWLNCZE1Z	Evaluation Board for ISL9305IRTHWLNCZ							

### NOTES:

1. Please refer to [TB347](#) for details on reel specifications.
2. These Intersil Pb-free plastic packaged products employ special Pb-free material sets, molding compounds/die attach materials, and 100% matte tin plate plus anneal (e3 termination finish, which is RoHS compliant and compatible with both SnPb and Pb-free soldering operations). Intersil Pb-free products are MSL classified at Pb-free peak reflow temperatures that meet or exceed the Pb-free requirements of IPC/JEDEC J STD-020.
3. For Moisture Sensitivity Level (MSL), please see device information page for [ISL9305H](#). For more information on MSL please see techbrief [TB363](#).

**Absolute Maximum Ratings** (Refer to ground)

SW1, SW2	-1.5V to 6.5V
FB1, FB2	-0.3V to 3.6V
GNDDCD1, GNDDCD2, GNDLDO	-0.3V to 0.3V
All Other Pins	-0.3V to 6.5V
<b>ESD Ratings</b>	
Human Body Model (Tested per JESD22-A114F)	3.5kV
Machine Model (Tested per JESD22-A115-A)	225V
Charged Device Model (Tested per JESD22-C101D)	2.2kV
Latch Up (Tested per JESD78B, Class II, Level A)	100mA

**Thermal Information**

Thermal Resistance (Typical)	$\theta_{JA}$ (°C/W)	$\theta_{JC}$ (°C/W)
16 Ld TQFN Package (Notes 4, 5)	40.2	5
Maximum Junction Temperature Range	-40°C to +150°C	
Recommended Junction Temperature Range	-40°C to +125°C	
Storage Temperature Range	-40°C to +150°C	
Pb-free reflow profile	see link below	
	<a href="http://www.intersil.com/pbfree/Pb-FreeReflow.asp">http://www.intersil.com/pbfree/Pb-FreeReflow.asp</a>	

**Recommended Operating Conditions**

VINDCD1	2.5V to 5.5V
VINDCD2	2.5V to VINDCD1
VINLDO1 and VINLDO2	1.5V to VINDCD1
DCD1 and DCD2 Output Current	0A to 1.5A
LDO1 and LDO2 Output Current	0mA to 300mA
Operating Ambient Temperature	-40°C to +85°C

**CAUTION:** Do not operate at or near the maximum ratings listed for extended periods of time. Exposure to such conditions may adversely impact product reliability and result in failures not covered by warranty.

**NOTES:**

- $\theta_{JA}$  is measured in free air with the component mounted on a high effective thermal conductivity test board with "direct attach" features. See Tech Brief TB379.
- $\theta_{JC}$ , "case temperature" location is at the center of the exposed metal pad on the package underside.

**Electrical Specifications** Unless otherwise noted, all parameter limits are guaranteed over the recommended operating conditions and the typical specifications are measured at the following conditions:  $T_A = +25^\circ\text{C}$ , VINDCD1 = 3.6V, VINDCD2 = 3.3V. For LDO1 and LDO2, VINLDOx = VOLDOx + 0.5V to 5.5V with VINLDOx always no higher than VINDCD1, L1 = L2 = 1.5 $\mu\text{H}$ , C1 = 10 $\mu\text{F}$ , C4 = C5 = 10 $\mu\text{F}$ , C2 = C3 = C6 = C7 = 1 $\mu\text{F}$ ,  $I_{OUT} = 0\text{A}$  for DCD1, DCD2, LDO1 and LDO2 (see "Typical Application Diagram" on page 1 for more details). **Boldface limits apply over the operating temperature range, -40°C to +85°C.**

PARAMETER	SYMBOL	TEST CONDITIONS	MIN (Note 6)	TYP	MAX (Note 6)	UNIT
VINDCD1, VINDCD2 Voltage Range			<b>2.5</b>	-	<b>5.5</b>	V
VINDCD1, VINDCD2 Undervoltage Lockout Threshold	$V_{UVLO}$	Rising	-	2.2	<b>2.3</b>	V
		Falling	<b>1.9</b>	2.1	-	V
Quiescent Supply Current on VINDCD1	$I_{VIN1}$	Only DCD1 enabled, no load and no switching on DCD1	-	40	<b>60</b>	$\mu\text{A}$
	$I_{VIN2}$	Only DCD1 and LDO1 enabled, with no load and no switching on DCD1	-	60	<b>95</b>	$\mu\text{A}$
	$I_{VIN3}$	Both DCD1 and DCD2 enabled, no load and no switching on both DCD1 and DCD2	-	50	<b>75</b>	$\mu\text{A}$
	$I_{VIN4}$	Only LDO1 and LDO2 enabled	-	75	<b>100</b>	$\mu\text{A}$
	$I_{VIN5}$	DCD1, DCD2, LDO1 and LDO2 are enabled, with no load and no switching on both DCD1 and DCD2	-	100	<b>130</b>	$\mu\text{A}$
	$I_{VIN6}$	Only one DCD in forced PWM mode, no load	-	4	<b>7.5</b>	mA
Shutdown Supply Current	$I_{SD}$	VINDCD1 = 5.5V, DCD1, DCD2, LDO1 and LDO2 are disabled through I <sup>2</sup> C interface, VINDCD1 = 4.2V	-	0.15	<b>5</b>	$\mu\text{A}$
Thermal Shutdown			-	155	-	°C
Thermal Shutdown Hysteresis			-	30	-	°C
<b>DCD1 AND DCD2</b>						
FB1, FB2 Regulation Voltage	$V_{FB}$		<b>0.785</b>	0.8	<b>0.815</b>	V
FB1, FB2 Bias Current	$I_{FB}$	FB = 0.75V	-	0.001	-	$\mu\text{A}$
Output Voltage Accuracy		$V_{IN} = V_O + 0.5\text{V}$ to 5.5V (minimal 2.5V), 1mA load	<b>-3</b>	-	<b>+3</b>	%

**Electrical Specifications** Unless otherwise noted, all parameter limits are guaranteed over the recommended operating conditions and the typical specifications are measured at the following conditions:  $T_A = +25^\circ\text{C}$ ,  $V_{\text{INDCD1}} = 3.6\text{V}$ ,  $V_{\text{INDCD2}} = 3.3\text{V}$ . For LDO1 and LDO2,  $V_{\text{INLDOx}} = V_{\text{OLDOx}} + 0.5\text{V}$  to  $5.5\text{V}$  with  $V_{\text{INLDOx}}$  always no higher than  $V_{\text{INDCD1}}$ ,  $L1 = L2 = 1.5\mu\text{H}$ ,  $C1 = 10\mu\text{F}$ ,  $C4 = C5 = 10\mu\text{F}$ ,  $C2 = C3 = C6 = C7 = 1\mu\text{F}$ ,  $I_{\text{OUT}} = 0\text{A}$  for DCD1, DCD2, LDO1 and LDO2 (see "Typical Application Diagram" on page 1 for more details). **Boldface limits apply over the operating temperature range,  $-40^\circ\text{C}$  to  $+85^\circ\text{C}$ .** (Continued)

PARAMETER	SYMBOL	TEST CONDITIONS	MIN (Note 6)	TYP	MAX (Note 6)	UNIT
Line Regulation		$V_{\text{IN}} = V_{\text{O}} + 0.5\text{V}$ to $5.5\text{V}$ (minimal $2.5\text{V}$ )	-	0.1	-	%/V
Maximum Output Current			<b>1500</b>	-	-	mA
P-Channel MOSFET ON-resistance		$V_{\text{IN}} = 3.6\text{V}$ , $I_{\text{O}} = 200\text{mA}$	-	0.14	<b>0.20</b>	$\Omega$
		$V_{\text{IN}} = 2.3\text{V}$ , $I_{\text{O}} = 200\text{mA}$	-	0.24	<b>0.40</b>	$\Omega$
N-Channel MOSFET ON-resistance		$V_{\text{IN}} = 3.6\text{V}$ , $I_{\text{O}} = 200\text{mA}$	-	0.11	<b>0.20</b>	$\Omega$
		$V_{\text{IN}} = 2.3\text{V}$ , $I_{\text{O}} = 200\text{mA}$		0.18	<b>0.34</b>	$\Omega$
P-Channel MOSFET Peak Current Limit	$I_{\text{PK}}$		<b>2.1</b>	2.5	<b>2.75</b>	A
SW Maximum Duty Cycle			-	100	-	%
SW Leakage Current		$V_{\text{IN}} = 5.5\text{V}$	-	0.005	<b>1</b>	$\mu\text{A}$
PWM Switching Frequency	$f_{\text{S}}$		<b>2.6</b>	3.0	<b>3.4</b>	MHz
SW Minimum ON-time		$V_{\text{FB}} = 0.75\text{V}$	-	70	-	ns
Bleeding Resistor			-	<b>115</b>	-	$\Omega$
<b>PG</b>						
Output Low Voltage		Sinking $1\text{mA}$ , $\text{FB1} = \text{FB2} = 0.7\text{V}$	-	-	<b>0.25</b>	V
Rising Delay Time		Based on $1\text{ms}$ programmed nominal delay time	<b>0.6</b>	1.1	<b>1.8</b>	ms
Falling Delay Time		Based on $1\text{ms}$ programmed nominal delay time	-	30	-	$\mu\text{s}$
PG Pin Leakage Current		$\text{PG} = V_{\text{INDCD1}} = V_{\text{INDCD2}} = 3.6\text{V}$	-	0.005	<b>0.1</b>	$\mu\text{A}$
PG Low Rising Threshold		Percentage of nominal regulation voltage	-	91	-	%
PG Low Falling Threshold		Percentage of nominal regulation voltage	-	87	-	%
PG High Rising Threshold		Percentage of nominal regulation voltage	-	<b>112</b>	-	%
PG High Falling Threshold		Percentage of nominal regulation voltage	-	109	-	%
<b>LDO1 AND LDO2</b>						
VINLDO1, VINLDO2 Supply Voltage		No higher than $V_{\text{INDCD1}}$	<b>1.5</b>	-	<b>5.5</b>	V
VINLDO1, VINLDO2 Undervoltage Lockout Threshold	$V_{\text{UVLO}}$	Rising	-	1.41	<b>1.46</b>	V
		Falling	<b>1.33</b>	1.37	-	V
Internal Peak Current Limit			<b>350</b>	425	<b>540</b>	mA
Dropout Voltage		$I_{\text{O}} = 300\text{mA}$ , $V_{\text{O}} \leq 2.1\text{V}$	-	120	<b>250</b>	mV
		$I_{\text{O}} = 300\text{mA}$ , $2.1\text{V} < V_{\text{O}} \leq 2.8\text{V}$	-	100	<b>200</b>	mV
		$I_{\text{O}} = 300\text{mA}$ , $V_{\text{O}} > 2.8\text{V}$	-	80	<b>170</b>	mV
Power Supply Rejection Ratio		$I_{\text{O}} = 300\text{mA}$ @ $1\text{kHz}$ , $V_{\text{IN}} = 3.6\text{V}$ , $V_{\text{O}} = 2.6\text{V}$ , $T_A = +25^\circ\text{C}$	-	55	-	dB
Output Voltage Noise		$V_{\text{IN}} = 4.2\text{V}$ , $I_{\text{O}} = 10\text{mA}$ , $T_A = +25^\circ\text{C}$ , $\text{BW} = 10\text{Hz}$ to $100\text{kHz}$	-	45	-	$\mu\text{V}_{\text{RMS}}$

## NOTE:

6. Parameters with MIN and/or MAX limits are 100% tested at  $+25^\circ\text{C}$ , unless otherwise specified. Temperature limits established by characterization and are not production tested.

## Theory of Operation

### DCD1 and DCD2 Introduction

Both the DCD1 and DCD2 converters on ISL9305H use the peak-current-mode pulse-width modulation (PWM) control scheme for fast transient response and pulse-by-pulse current limiting. Both converters are able to supply up to 1.5A load current. The default output voltage ranges from 0.8V to 3.6V depending on the factory pre-set configuration and can be programmed via the I<sup>2</sup>C interface in the range of 0.825V to 3.6V at 25mV/step with a programmable slew rate. An open-drain DCDPG (DCD Power-Good) signal is also provided to monitor the DCD1 and DCD2 output voltages. Optionally, both DCD1 and DCD2 can be programmed to be actively discharged via an on-chip blebbing resistor (typical 115Ω) when the converter is disabled.

### Skip Mode (PFM Mode) for DCD1/DCD2

Under light load condition, the DCD1 and DCD2 can be programmed to automatically enter a pulse-skipping mode to minimize the switching loss by reducing the switching frequency. Figure 3 illustrates the skip mode operation. A zero-cross sensing circuit monitors the current flowing through SW node for zero crossing. When it is detected to cross zero for 16 consecutive cycles, the regulator enters the skip mode. During the 16 consecutive cycles, the inductor current could be negative. The counter is reset to zero when the sensed current flowing through the SW node does not cross zero during any cycle within the 16 consecutive cycles. Once the converter enters the skip mode, the pulse modulation is controlled by an internal comparator while each pulse cycle remains synchronized to the PWM clock. The P-Channel MOSFET is turned on at the rising edge of the clock and turned off when its current reaches ~20% of the peak current limit. As the average inductor current in each cycle is higher than the average current of the load, the output voltage rises cycle-over-cycle. When the output voltage is sensed to reach 1.5% above its nominal voltage, the P-Channel MOSFET is turned off immediately and the inductor current is fully discharged to zero and stays at zero. The output voltage reduces gradually due to the load current discharging the output capacitor. When the output voltage drops to the nominal voltage, the P-Channel MOSFET will be turned on again, repeating the previous operations.



FIGURE 3. SKIP MODE OPERATION WAVEFORMS

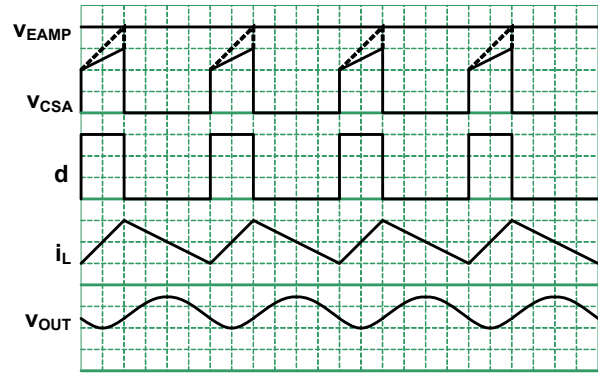

FIGURE 2. PWM OPERATION WAVEFORMS

The regulator resumes normal PWM mode operation when the output voltage is sensed to drop below 1.5% of its nominal voltage value.

### Soft-Start

The soft-start reduces the in-rush current during the start-up stage. The soft-start block limits the current rising speed so that the output voltage rises in a controlled fashion.

### Overcurrent Protection

The overcurrent protection for DCD1 and DCD2 is provided on the ISL9305H when an overload condition occurs. When the current at P-Channel MOSFET is sensed to reach the current limit, the internal protection circuit is triggered to turn off the P-Channel MOSFET immediately.

### DCD Short-Circuit Protection

The ISL9305H provides Short-Circuit Protection for both DCD1 and DCD2. The feedback voltage is monitored for output short-circuit protection. When the output voltage is sensed to be lower than a certain threshold, the internal circuit will change the PWM oscillator frequency to a lower frequency in order to protect the IC from damage. The P-Channel MOSFET peak current limit remains active during this state.

## Undervoltage Lockout (UVLO)

An undervoltage lockout (UVLO) circuit is provided on ISL9305H. The UVLO circuit block can prevent abnormal operation in the event that the supply voltage is too low to guarantee proper operation. The UVLO on VINDCD1 is set for a typical 2.2V with 100mV hysteresis. VINLDO1 and VINLDO2 are set for a typical 1.4V with 50mV hysteresis. When the input voltage is sensed to be lower than the UVLO threshold, the related channel is disabled.

## DCDPG (DCD Power-Good)

ISL9305H offers an open-drain Power-Good signal with programmable delay time for monitoring the converters DCD1 and DCD2 output voltage status.

When both DCD1 and DCD2 are enabled and their output voltages are within the power-good window, an internal power-good signal is issued to turn off the open-drain MOSFET so the DCDPG pin voltage can be externally pulled high after a programmed delay time. If either DCD1 or DCD2 output voltages or both of them are not within the power-good window, the DCDPG outputs an open-drain logic low signal after the programmed delay time.

When only one DCD converter (either DCD1 or DCD2) is enabled, then the DCDPG only indicates the status of this active DCD converter. For example, if only DCD1 converter is enabled and DCD2 converter is disabled, when DCD1 output is within the power-good window, an internal power-good signal will be issued to turn off the open-drain MOSFET so the DCDPG pin voltage is externally pulled high after the programmed delay time. If the output voltage of DCD1 is outside the power-good window, the DCDPG outputs an open-drain logic low signal after the programmed delay time. It is similar when only DCD2 is enabled and DCD1 is disabled. When both converters are disabled, DCDPG always outputs the open-drain logic low signal.

## Low Dropout Operation

Both DCD1 and DCD2 converters feature the low dropout operation to maximize the battery life. When the input voltage drops to a level that the converter can no longer operate under switching regulation to maintain the output voltage, the P-Channel MOSFET is completely turned on (100% duty cycle). The dropout voltage under such a condition is the product of the load current and the ON-resistance of the P-Channel MOSFET. Minimum required input voltage  $V_{IN}$  under such condition is the sum of output voltage plus the voltage drop across the inductor and the P-Channel MOSFET switch.

## Active Output Voltage Discharge for DCD1/DCD2

The ISL9305H offers a feature to actively discharge the output voltage of DCD1 and DCD2 via an internal bleeding resistor (typical 115 $\Omega$ ) when the channel is disabled. This feature is enabled by default, but individual outputs can be disabled through programming the control bit in the DCD\_PARAMETER register.

## Thermal Shutdown

The ISL9305H provides a built-in thermal protection function with thermal shutdown threshold temperature set at +155 $^{\circ}$ C with +25 $^{\circ}$ C hysteresis (typical). When the die temperature is sensed to reach +130 $^{\circ}$ C, the regulator is completely shut down and as the temperature is sensed to drop to +105 $^{\circ}$ C (typical), the device resumes normal operation starting from the soft-start.

## I<sup>2</sup>C Compatible Interface

The ISL9305H offers an I<sup>2</sup>C compatible interface, using two pins: SCLK for the serial clock and SDAT for serial data respectively. According to the I<sup>2</sup>C specifications, a pull-up resistor is needed for the clock and data signals to connect to a positive supply. When the ISL9305 and the host use different supply voltages, the pull-up resistors should be connected to the higher voltage rail.

Signal timing specifications should satisfy the standard I<sup>2</sup>C bus specification. The maximum bit rate is 400kb/s and more details regarding the I<sup>2</sup>C specifications can be found from Philips.

## I<sup>2</sup>C Slave Address

The ISL9305H serves as a slave device and the 7-bit default chip address is 1101000, as shown in Figure 4. According to the I<sup>2</sup>C specifications, here the value of Bit 0 determines the direction of the message ("0" means "write" and "1" means "read").

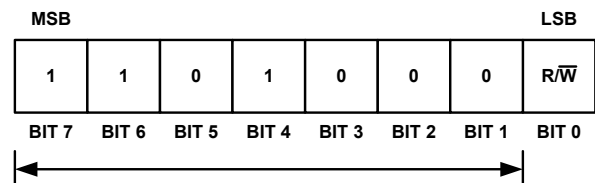

FIGURE 4. I<sup>2</sup>C SLAVE ADDRESS

## I<sup>2</sup>C Protocol

Figures 5, 6, and 7 show three typical I<sup>2</sup>C-bus transaction protocols.





FIGURE 5. I<sup>2</sup>C WRITE



FIGURE 6. I<sup>2</sup>C READ SPECIFYING REGISTER ADDRESS

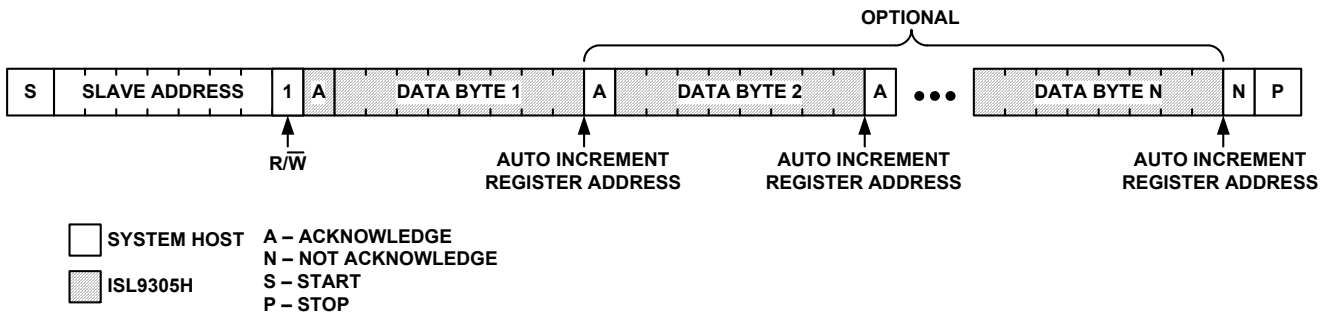

FIGURE 7. I<sup>2</sup>C READ NOT SPECIFYING REGISTER ADDRESS

## I<sup>2</sup>C Control Registers

All the registers are reset at initial start-up.

### DCD OUTPUT VOLTAGE CONTROL REGISTER

DCD1OUT, address 0x00h; DCD2OUT, address 0x01h

The output voltages of the two DC/DC converters at power-up are internally fixed by the IC fuse as dictated by the part number. After power-up, different voltages can be selected (except for the adjustable version) by first writing a desired value to this register. Then write a “1” to Bit 6 of the SYS\_PARAMETER (Table 7) to change the voltage control method to I2C control.

TABLE 2. BUCK CONVERTERS OUTPUT VOLTAGE CONTROL REGISTER

BIT	NAME	ACCESS	DEFAULT	DESCRIPTION
B7	Reserve	-	0	Refer to Table 3
B6	DCDxOUT-6	R/W	0	
B5	DCDxOUT-5	R/W	0	
B4	DCDxOUT-4	R/W	1	
B3	DCDxOUT-3	R/W	0	
B2	DCDxOUT-2	R/W	0	
B1	DCDxOUT-1	R/W	0	
B0	DCDxOUT-0	R/W	0	

TABLE 3. DCD1 AND DCD2 OUTPUT VOLTAGE SETTING

DCDOUT <7:0>	DCD OUTPUT VOLTAGE (V)	DCDOUT <7:0>	DCD OUTPUT VOLTAGE (V)	DCDOUT <7:0>	DCD OUTPUT VOLTAGE (V)	DCDOUT <7:0>	DCD OUTPUT VOLTAGE (V)
00	0.825	20	1.625	40	2.425	60	3.225
01	0.850	21	1.650	41	2.450	61	3.250
02	0.875	22	1.675	42	2.475	62	3.275
03	0.900	23	1.700	43	2.500	63	3.300
04	0.925	24	1.725	44	2.525	64	3.325
05	0.950	25	1.750	45	2.550	65	3.350
06	0.975	26	1.775	46	2.575	66	3.375
07	1.000	27	1.800	47	2.600	67	3.400
08	1.025	28	1.825	48	2.625	68	3.425
09	1.050	29	1.850	49	2.650	69	3.450
0A	1.075	2A	1.875	4A	2.675	6A	3.475
0B	1.100	2B	1.900	4B	2.700	6B	3.500
0C	1.125	2C	1.925	4C	2.725	6C	3.525
0D	1.150	2D	1.950	4D	2.750	6D	3.550
0E	1.175	2E	1.975	4E	2.775	6E	3.575
0F	1.200	2F	2.000	4F	2.800	6F	3.600
10	1.225	30	2.025	50	2.825		
11	1.250	31	2.050	51	2.850		
12	1.275	32	2.075	52	2.875		
13	1.300	33	2.100	53	2.900		
14	1.325	34	2.125	54	2.925		
15	1.350	35	2.150	55	2.950		
16	1.375	36	2.175	56	2.975		
17	1.400	37	2.200	57	3.000		
18	1.425	38	2.225	58	3.025		
19	1.450	39	2.250	59	3.050		
1A	1.475	3A	2.275	5A	3.075		
1B	1.500	3B	2.300	5B	3.100		
1C	1.525	3C	2.325	5C	3.125		
1D	1.550	3D	2.350	5D	3.150		
1E	1.575	3E	2.375	5E	3.175		
1F	1.600	3F	2.400	5F	3.200		

## LDO1 AND LDO2 OUTPUT VOLTAGE CONTROL REGISTERS

LDO1OUT, address 0x02h and LDO2OUT, address 0x03h.

The output voltages of the two LDO's at power-up are internally fixed by the IC fuse as dictated by the part number. After power-up, different voltages can be selected by first writing a desired value to this register. Then write a "1" to Bit 6 of the SYS\_PARAMETER (Table 7) to change the voltage control method to I2C control.

TABLE 4. LDOX OUTPUT VOLTAGE CONTROL REGISTERS

BIT	NAME	ACCESS	DEFAULT	DESCRIPTION
B7	Reserve	-	0	Refer to Table 5 for output voltage settings
B6	Reserve	-	0	
B5	LDOxOUT-5	R/W	0	
B4	LDOxOUT-4	R/W	0	
B3	LDOxOUT-3	R/W	1	
B2	LDOxOUT-2	R/W	1	
B1	LDOxOUT-1	R/W	0	
B0	LDOxOUT-0	R/W	0	

TABLE 5. LDOX OUTPUT VOLTAGE SETTINGS

LDOOUT <7:0>	LDO OUTPUT VOLTAGE (V)	LDOOUT <7:0>	LDO OUTPUT VOLTAGE (V)	LDOOUT <7:0>	LDO OUTPUT VOLTAGE (V)	LDOOUT <7:0>	LDO OUTPUT VOLTAGE (V)
00	0.9	10	1.70	20	2.50	30	3.30
01	0.95	11	1.75	21	2.55	31	3.35
02	1.00	12	1.80	22	2.60	32	3.40
03	1.05	13	1.85	23	2.65	33	3.45
04	1.1	14	1.90	24	2.70	34	3.50
05	1.15	15	1.95	25	2.75	35	3.55
06	1.20	16	2.00	26	2.80	36	3.60
07	1.25	17	2.05	27	2.85		
08	1.30	18	2.10	28	2.90		
09	1.35	19	2.15	29	2.95		
0A	1.40	1A	2.20	2A	3.00		
0B	1.45	1B	2.25	2B	3.05		
0C	1.50	1C	2.30	2C	3.10		
0D	1.55	1D	2.35	2D	3.15		
0E	1.60	1E	2.40	2E	3.20		
0F	1.65	1F	2.45	2F	3.25		

**DCD1 AND DCD2 CONTROL REGISTER**

DCD\_PARAMETER, address 0x04h

**TABLE 6. DCD\_PARAMETER REGISTER**

BIT	NAME	ACCESS	RESET	DESCRIPTION
B7	-	-	0	Reserved
B6	DCD_PHASE	R/W	0	DCD1 and DCD2 PWM switch selection. 0-in phase; 1 to 180° out-of-phase.
B5	DCD2_ULTRA	R/W	0	Ultrasonic feature under PFM mode for DCD2. 0-disabled; 1-enabled.
B4	DCD1_ULTRA	R/W	0	Ultrasonic feature under PFM mode for DCD1. 0-disabled; 1-enabled.
B3	DCD2_BLD	R/W	1	Selection of DCD2 for active output voltage discharge when disabled. 0-disabled; 1-enabled.
B2	DCD1_BLD	R/W	1	Selection of DCD1 for active output voltage discharge when disabled. 0-disabled; 1-enabled.
B1	DCD2_MODE	R/W	1	Selection on DCD2 of auto PFM/PWM mode (= 1) or forced PWM mode (= 0).
B0	DCD1_MODE	R/W	1	Selection on DCD1 of auto PFM/PWM mode (= 1) or forced PWM mode (= 0).

**DCD OUTPUT VOLTAGE SLEW RATE CONTROL REGISTER**

DCD\_SRCTL, address 0x06h

**TABLE 8. DCD OUTPUT VOLTAGE SLEW RATE CONTROL REGISTER**

BIT	NAME	ACCESS	RESET	DESCRIPTION
B7	DCD2SR_2	R/W	0	DCD2 Slew Rate Setting, DCD2SR[2:0]: 000 to 0.225mV/μs 001 to 0.45mV/μs 010 to 0.90mV/μs 011 to 1.8mV/μs 100 to 3.6mV/μs 101 to 7.2mV/μs 110 to 14.4mV/μs 111 to 28.8mV/μs
B6	DCD2SR_1	R/W	0	
B5	DCD2SR_0	R/W	1	
B4	Reserve	-	0	Reserved
B3	DCD1SR_2	R/W	0	DCD1 Slew Rate Setting, DCD1SR[2:0]: 000 to 0.225mV/μs 001 to 0.45mV/μs 010 to 0.90mV/μs 011 to 1.8mV/μs 100 to 3.6mV/μs 101 to 7.2mV/μs 110 to 14.4mV/μs 111 to 28.8mV/μs
B2	DCD1SR_1	R/W	0	
B1	DCD1SR_0	R/W	1	
B0	Reserve	-	0	Reserved

**SYSTEM CONTROL REGISTER**

SYS\_PARAMETER, address 0x05h

**TABLE 7. SYS\_PARAMETER REGISTER**

BIT	NAME	ACCESS	RESET	DESCRIPTION
B7	-	-	0	Reserved
B6	I <sup>2</sup> C_CTRL	R/W	0	Output voltage control method, 0-fuse control; 1-I <sup>2</sup> C control
B5	DCDPOR_1	R/W	1	DCDPG Delay Time Setting, DCDPG[1:0]: 00 to 1ms 01 to 50ms 10 to 150ms 11 to 200m
B4	DCDPOR_0	R/W	0	
B3	LDO2_EN	R/W	1	LDO2 enable selection. 0-disable, 1-enable.
B2	LDO1_EN	R/W	1	LDO1 enable selection. 0-disable, 1-enable
B1	DCD2_EN	R/W	1	DCD2 enable selection. 0-disable, 1-enable.
B0	DCD1_EN	R/W	1	DCD1 enable selection. 0-disable, 1-enable

# Typical Operating Conditions



**FIGURE 8. DCD OUTPUT RIPPLE ( $V_{IN} = 4.2V$ , PFM, TIME SCALE =  $1\mu s$ )**  
 CH1: VODCD1 (20mV/DIV), CH2: IL1 (500mA/DIV),  
 CH3: VODCD2 (20mV/DIV), CH4: IL2 (500mA/DIV)

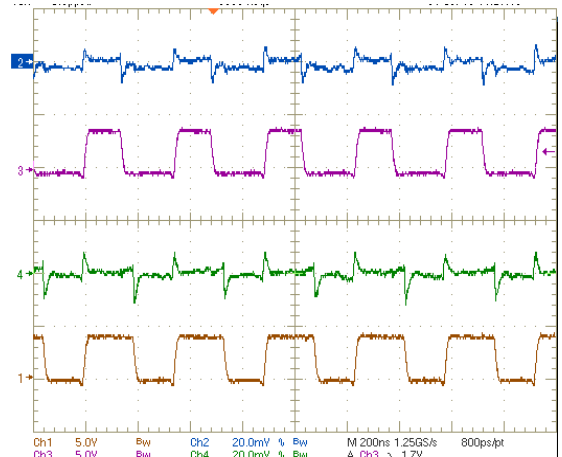

**FIGURE 9. DCD OUTPUT RIPPLE ( $V_{IN} = 4.2V$ , FULL LOADING @ VODCD1 AND VODCD2, TIME SCALE = 200ns)**  
 CH1: SW1 (5V/DIV), CH2: VODCD1 (20mA/DIV),  
 CH3: SW2 (5V/DIV), CH4: VODCD2 (20mA/DIV)

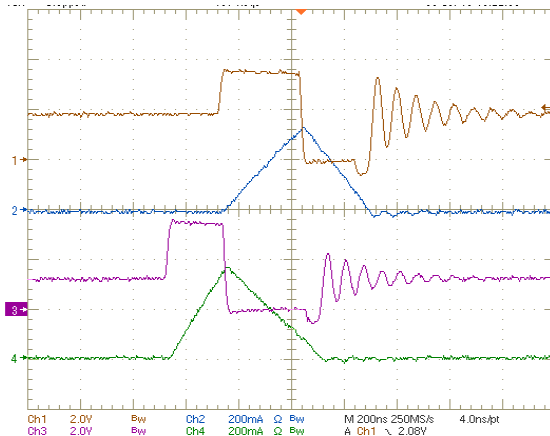

**FIGURE 10. INDUCTOR CURRENT RIPPLE ( $V_{IN} = 3.6V$ , PFM, TIME SCALE = 200ns)** CH1: SW1 (2V/DIV),  
 CH2: IL1 (200mA/DIV), CH3: SW2 (2V/DIV),  
 CH4: IL2 (200mA/DIV)

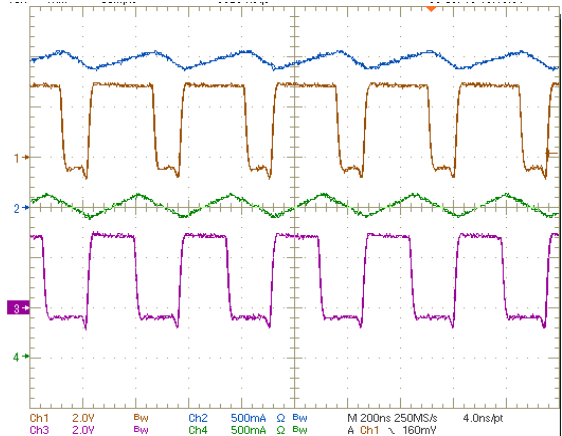

**FIGURE 11. INDUCTOR CURRENT RIPPLE ( $V_{IN} = 3.6V$ , FULL LOADING, PWM, TIME SCALE = 200ns)** CH1: SW1 (2V/DIV),  
 CH2: IL1 (500mA/DIV), CH3: SW2 (2V/DIV),  
 CH4: IL2 (500mA/DIV)

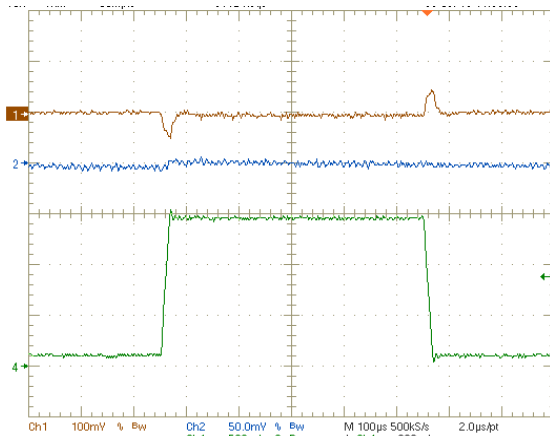

**FIGURE 12. DCD1 TRANSIENT RESPONSE ( $V_{IN} = 3.6V$ , STEP LOAD: 150mA TO 1500mA)** CH1: VODCD1 (100mV/DIV, AC),  
 CH2: VODCD2 (50mV/DIV, AC), CH4: IL4 (500mA/DIV)

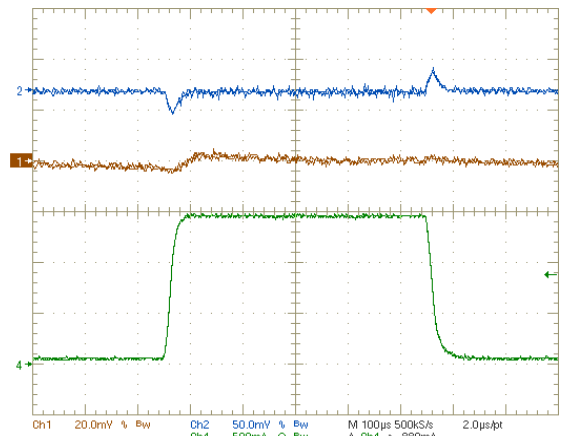

**FIGURE 13. DCD2 TRANSIENT RESPONSE ( $V_{IN} = 3.6V$ , STEP LOAD: 150mA TO 1500mA)** CH1: VODCD1 (100mV/DIV, AC),  
 CH2: VODCD2 (50mV/DIV, AC), CH4: IL4 (500mA/DIV)

# Typical Operating Conditions (Continued)



**FIGURE 14. 4-CHANNEL DEFAULT START-UP @ NO LOAD**  
 CH1: VODCD1 (2V/DIV), CH2: VODCD2 (1V/DIV),  
 CH3: VOLDO1 (1V/DIV), CH4: VOLDO2 (2V/DIV)



**FIGURE 15. 4-CHANNEL DEFAULT START-UP @ FULL LOAD**  
 CH1: VODCD1 (2V/DIV), CH2: VODCD2 (1V/DIV),  
 CH3: VOLDO1 (1V/DIV), CH4: VOLDO2 (2V/DIV)



**FIGURE 16. EFFICIENCY vs LOAD ( $V_{OUT} = 1.8V$ , PFM/PWM)**

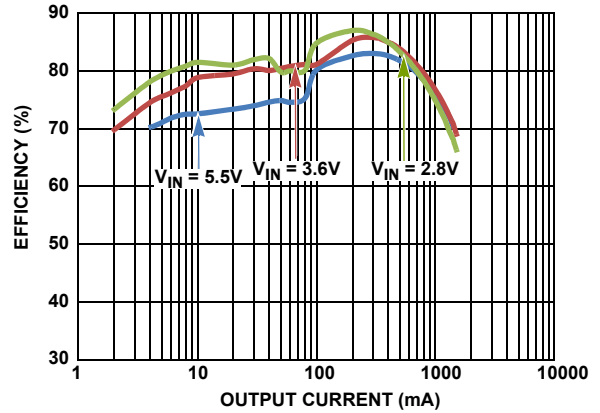

**FIGURE 17. EFFICIENCY vs LOAD ( $V_{OUT} = 1.2V$ , FORCED PWM)**

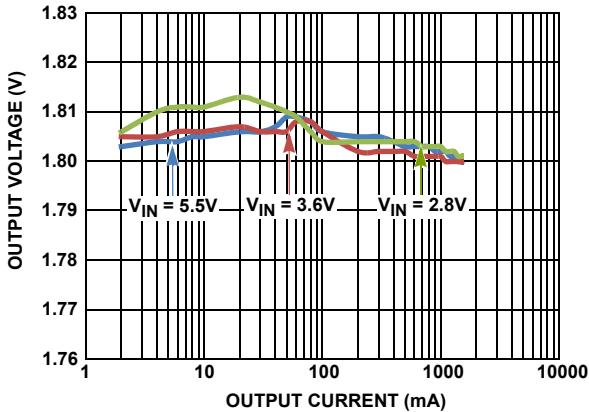

**FIGURE 18. DCD OUTPUT VOLTAGE vs OUTPUT CURRENT**  
 ( $V_{OUT} = 1.8V$ , PFM/PWM)

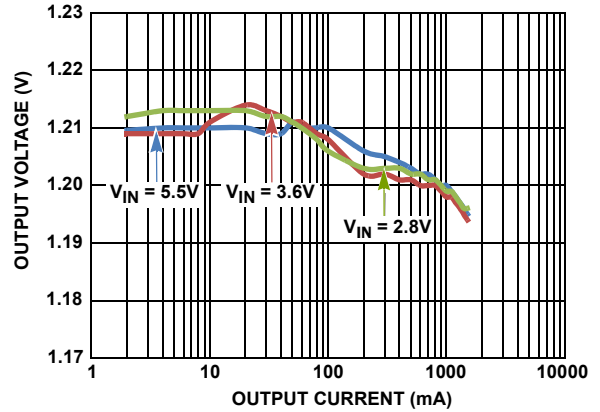

**FIGURE 19. DCD OUTPUT VOLTAGE vs OUTPUT CURRENT**  
 ( $V_{OUT} = 1.2V$ , PFM/PWM)

## Typical Operating Conditions (Continued)

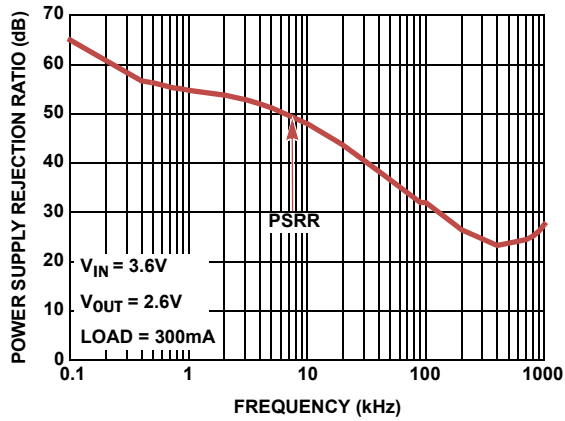

FIGURE 20. RIPPLE REJECTION RATIO vs FREQUENCY



FIGURE 21. QUIESCENT CURRENT vs INPUT VOLTAGE

© Copyright Intersil Americas LLC 2010-2014. All Rights Reserved.  
 All trademarks and registered trademarks are the property of their respective owners.

For additional products, see [www.intersil.com/en/products.html](http://www.intersil.com/en/products.html)

Intersil products are manufactured, assembled and tested utilizing ISO9001 quality systems as noted in the quality certifications found at [www.intersil.com/en/support/qualandreliability.html](http://www.intersil.com/en/support/qualandreliability.html)

*Intersil products are sold by description only. Intersil may modify the circuit design and/or specifications of products at any time without notice, provided that such modification does not, in Intersil's sole judgment, affect the form, fit or function of the product. Accordingly, the reader is cautioned to verify that datasheets are current before placing orders. Information furnished by Intersil is believed to be accurate and reliable. However, no responsibility is assumed by Intersil or its subsidiaries for its use; nor for any infringements of patents or other rights of third parties which may result from its use. No license is granted by implication or otherwise under any patent or patent rights of Intersil or its subsidiaries.*

For information regarding Intersil Corporation and its products, see [www.intersil.com](http://www.intersil.com)

## Revision History

The revision history provided is for informational purposes only and is believed to be accurate, but not warranted. Please go to web to make sure you have the latest Rev.

DATE	REVISION	CHANGE
3/7/14	FN7724.2	<p>Pg4 - Added Evaluation board descriptions.</p> <p>Pg10 - Deleted Caution: Disable DCD prior to changing from fixed output voltage to adjustable output voltage or from adjustable output voltage to fixed output voltage using I<sup>2</sup>C. Added description of the DCD's output voltage control. Changed Table 2 column name from "RESET" to "DEFAULT."</p> <p>Pg11 - Added description of the LDO's output voltage control. Changed Table 4 column name from "RESET" to "DEFAULT."</p>
7/24/12		<p>Pg 1 - Changed "the ISL9305H can be ordered in factory pre-set power-up default voltages in increments of 100mV from 0.9V to 3.6V." to "the ISL9305H can be ordered in factory pre-set output voltage options from 0.9V to 3.6V in 50mV step."</p> <p>Pg 1 - Changed Related Literature AN1564 title from "ISL9305IRTZEVAL1Z and ISL9305HIRTZEVAL1Z Evaluation Boards" to "ISL9305 and ISL9305H Evaluation Boards"</p> <p>Pg 1 Features - Changed "at 50mV/Step.....0.9V to 3.3V" to "25mV/Step.....0.9V to 3.6V" under LD01/LD02 output voltage I<sup>2</sup>C programmability.</p> <p>Pg 3 - Changed the output capacitor value at VOLD01 and VOLD02 from "10uF" to "1uF" in the block diagram</p> <p>Pg 4 - List of Eval Board FGs in Ordering Information table changed from ISL9305IRTBCNLZE1Z, ISL9305IRTBFCZE1Z, ISL9305IRTAANLZE1Z to ISL9305IRTHAANLZE1Z, ISL9305IRTHBCNLZE1Z, ISL9305IRTHBFCZE1Z, ISL9305IRTHWBNLZE1Z, ISL9305IRTHWCLBZE1Z, ISL9305IRTHWCNLZE1Z, ISL9305IRTHWCNYZE1Z, ISL9305IRTHWLNCZE1Z</p> <p>Pg 5 - Abs Max Ratings, ESD Ratings changed from:  Machine Model (Tested per JESD22-A115-A) . . . . . 2.2kV  Charged Device Model (Tested per JESD22-C101D) . . . . . 225V  to:  Machine Model (Tested per JESD22-A115-A) . . . . . 225V  Charged Device Model (Tested per JESD22-C101D) . . . . . 2.2kV</p> <p>Pg 12 - Removed PCN "Note 7" under Table 8. Changed "111 to reserve for system use" to "111 to 28.8mV/μs."  - Changed "DCD2" to "DCD1" in line B0 of Table 7.</p>
5/23/11	FN7724.1	<p>-Table 8 on page 12 changed 111 description from "to immediate" to "reserved for system use (Note 7)."</p> <p>Added Note to Table 8, which reads "The IC can be damaged when output is programmed from high to low and the slew rate register is set to 111."</p> <p>Added Eval boards:  ISL9305IRTBCNLZE1Z  ISL9305IRTBFCZE1Z  ISL9305IRTAANLZE1Z</p> <p>-Corrected Theta JA Thermal Information on page 5 for TQFN from 42 to 40.2</p> <p>-"Electrical Specifications" on page 5:</p> <p>Added "Boldface limits apply over the operating temperature range, -40 °C to +85 °C." to common conditions. Bolded applicable specs.</p> <p>Changed "Compliance to datasheet limits is assured by one or more methods: production test, characterization and/or design." note in Electrical Spec Table on page 6 to "Parameters with MIN and/or MAX limits are 100% tested at +25 °C, unless otherwise specified. Temperature limits established by characterization and are not production tested." per Product Line decision.</p>
11/8/10	FN7724.0	Initial Release.

## About Intersil

Intersil Corporation is a leading provider of innovative power management and precision analog solutions. The company's products address some of the largest markets within the industrial and infrastructure, mobile computing and high-end consumer markets.

For the most updated datasheet, application notes, related documentation and related parts, please see the respective product information page found at [www.intersil.com](http://www.intersil.com).

You may report errors or suggestions for improving this datasheet by visiting [www.intersil.com/ask](http://www.intersil.com/ask).

Reliability reports are also available from our website at [www.intersil.com/support](http://www.intersil.com/support)



# Package Outline Drawing

## L16.4x4G

16 LEAD THIN QUAD FLAT NO-LEAD PLASTIC PACKAGE

Rev 0, 4/10

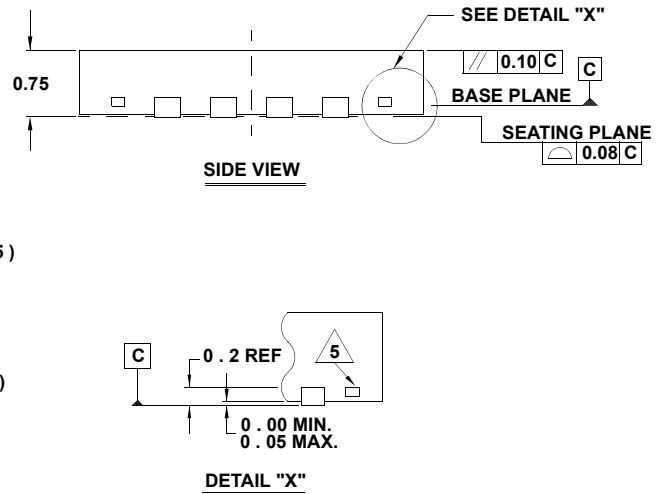
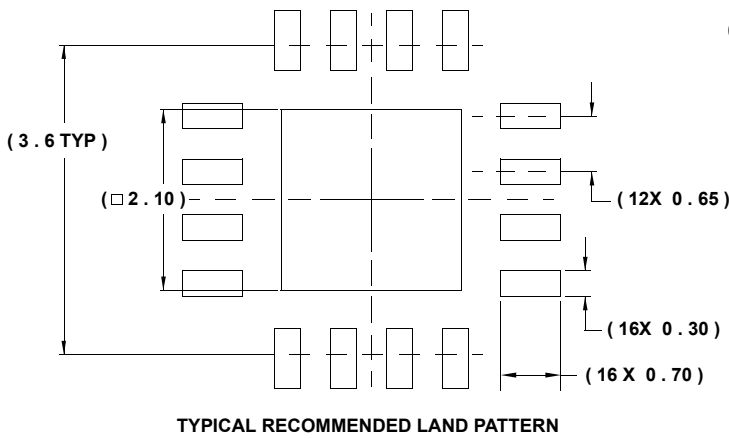
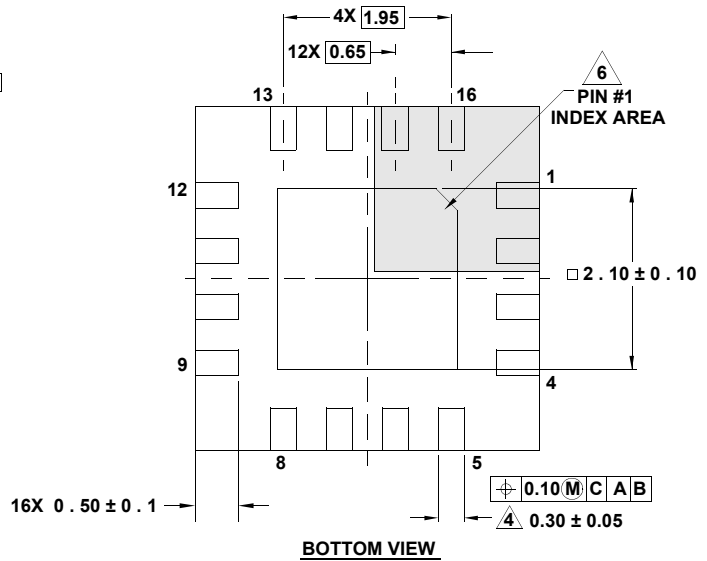
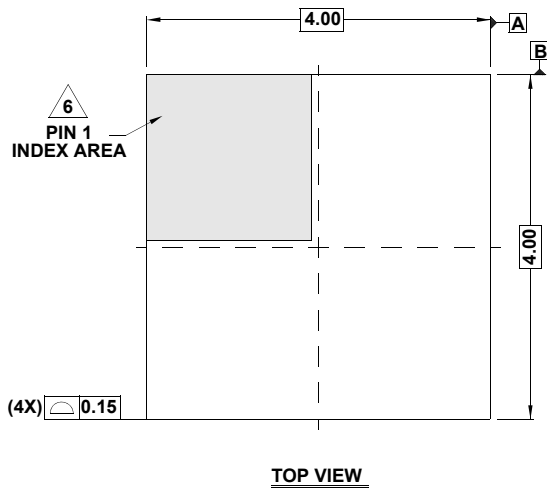

**NOTES:**

1. Dimensions are in millimeters.  
Dimensions in ( ) for Reference Only.
2. Dimensioning and tolerancing conform to ASME Y14.5m-1994.
3. Unless otherwise specified, tolerance : Decimal  $\pm 0.05$
4. Dimension applies to the metallized terminal and is measured between 0.15mm and 0.30mm from the terminal tip.
5. Tiebar shown (if present) is a non-functional feature.
6. The configuration of the pin #1 identifier is optional, but must be located within the zone indicated. The pin #1 identifier may be either a mold or mark feature.
7. JEDEC reference drawing: MO220K.



Компания «ЭлектроПласт» предлагает заключение долгосрочных отношений при поставках импортных электронных компонентов на взаимовыгодных условиях!

Наши преимущества:

- Оперативные поставки широкого спектра электронных компонентов отечественного и импортного производства напрямую от производителей и с крупнейших мировых складов;
- Поставка более 17-ти миллионов наименований электронных компонентов;
- Поставка сложных, дефицитных, либо снятых с производства позиций;
- Оперативные сроки поставки под заказ (от 5 рабочих дней);
- Экспресс доставка в любую точку России;
- Техническая поддержка проекта, помощь в подборе аналогов, поставка прототипов;
- Система менеджмента качества сертифицирована по Международному стандарту ISO 9001;
- Лицензия ФСБ на осуществление работ с использованием сведений, составляющих государственную тайну;
- Поставка специализированных компонентов (Xilinx, Altera, Analog Devices, Intersil, Interpoint, Microsemi, Aeroflex, Peregrine, Syfer, Eurofarad, Texas Instrument, Miteq, Cobham, E2V, MA-COM, Hittite, Mini-Circuits, General Dynamics и др.);

Помимо этого, одним из направлений компании «ЭлектроПласт» является направление «Источники питания». Мы предлагаем Вам помощь Конструкторского отдела:

- Подбор оптимального решения, техническое обоснование при выборе компонента;
- Подбор аналогов;
- Консультации по применению компонента;
- Поставка образцов и прототипов;
- Техническая поддержка проекта;
- Защита от снятия компонента с производства.



#### Как с нами связаться

**Телефон:** 8 (812) 309 58 32 (многоканальный)

**Факс:** 8 (812) 320-02-42

**Электронная почта:** [org@eplast1.ru](mailto:org@eplast1.ru)

**Адрес:** 198099, г. Санкт-Петербург, ул. Калинина, дом 2, корпус 4, литера А.