



## Features

- Available in a variety of pin-out configurations
- Virtually infinite electrical circuit isolation
- Metal or plastic shaft options
- RoHS compliant\*

## Model 91, 92, 93, 94 & 95 - 5/8" Square Single-Turn Panel Control

| Initial Electrical Characteristics <sup>1</sup>                                   | Conductive Plastic Element             | Cermet Element                        |
|---|--|---------------------------------------|
| Standard Resistance Range   |  |                                       |
| Linear Tapers (A, B, E, & H).....   | (B & E) 1 K ohms to 1 megohm.....      | (A & H) 100 ohms to 1 megohm          |
| Audio Tapers (C, D, F, G, S, & T).....  | (D,G,S, & T) 1 K ohms to 1 megohm..... | (C & F) 1 K ohms to 1 megohm          |
| Total Resistance Tolerance.....   | 10 % or 20 %.....                      | 5% or 10%                             |
| Independent Linearity.....  | ±5 %.....                              | ±5 %                                  |
| Absolute Minimum Resistance.....  | 2 ohms maximum.....                    | 2 ohms maximum                        |
| Effective Electrical Angle.....   | (Linear tapers) 240 ° ± 5 °.....       | (Linear tapers) 240 ° ± 6 °           |
|   | (Audio tapers) 225 ° ± 5 °.....        | (Audio tapers) 225 ° ± 6 °            |
| Contact Resistance Variation.....   | ±1 %.....                              | ±1 % or 3 ohms (whichever is greater) |
| Dielectric Withstanding Voltage (MIL-STD-202, Method 301)                         |  |                                       |
| Sea Level.....  | 1,500 VAC minimum.....                 | 1,500 VAC minimum                     |
| 70,000 Feet.....  | 500 VAC minimum.....                   | 500 VAC minimum                       |
| Insulation Resistance (500 VDC).....  | 1,000 megohms minimum.....             | 1,000 megohms minimum                 |
| Power Rating (Voltage Limited By Power Dissipation or 350 VAC, Whichever Is Less) |  |                                       |
| +70 °C Single Section Assembly.....   | (Linear tapers) 1 watt.....            | (Linear tapers) 2 watts               |
|   | (Audio tapers) 0.5 watt.....           | (Audio tapers) 1 watt                 |
| +70 °C Multiple Section Assembly.....   | (Linear tapers) 0.5 watt/section.....  | (Linear tapers) 1 watt/section        |
|   | (Audio tapers) 0.25 watt/section.....  | (Audio tapers) 0.5 watt/section       |
| +125 °C.....  | 0 watt.....                            | 0 watt                                |
| Theoretical Resolution.....   | Essentially infinite.....              | Essentially infinite                  |

| Environmental Characteristics <sup>1</sup>                 |  |                               |
|--|--|-------------------------------|
| Operating Temperature Range.....                           | -40 °C to +125 °C.....                         | -40 °C to +125 °C             |
| Storage Temperature Range.....                             | -55 °C to +125 °C.....                         | -55 °C to +125 °C             |
| Temperature Coefficient Over Storage                       |  |                               |
| Temperature Range.....                                     | ±1,000 ppm/°C.....                             | ±150 ppm/°C                   |
| Vibration (Single Section).....                            |  |                               |
| Total Resistance Shift.....                                | ±2 % maximum.....                              | ±2 % maximum                  |
| Voltage Ratio Shift.....                                   | ±5 % maximum.....                              | ±5 % maximum                  |
| Shock (Single Section).....                                |  |                               |
| Total Resistance Shift.....                                | ±2 % maximum.....                              | ±2 % maximum                  |
| Voltage Ratio Shift.....                                   | ±5 % maximum.....                              | ±5 % maximum                  |
| Load Life.....   |  |                               |
| Total Resistance Shift.....                                | ±10 % maximum.....                             | ±5 % maximum                  |
| Rotational Life (No Load).....                             |  |                               |
| Total Resistance Shift.....                                | (Linear tapers) 10 ohms or ±15 % TRS max. .... | (All tapers) ±5 % TRS max.    |
|  | (whichever is greater)                         |                               |
|  | (Audio tapers) ±20 % maximum                   |                               |
| Contact Resistance Variation                               |  |                               |
| @ 50,000 cycles.....                                       | (Linear tapers) ±2 %.....                      | ±2 %                          |
|  | (Audio tapers) ±3 %.....                       | ±3 %                          |
| Moisture Resistance (MIL-STD-202, Method 103, Condition B) |  |                               |
| Total Resistance Shift.....                                | (Linear tapers) ±10 % TRS maximum.....         | (All tapers) ±5 % TRS maximum |
|  | (Audio tapers) ±20 % TRS maximum               |                               |
| Insulation Resistance (500 VDC).....                       | 100 megohms minimum.....                       | 100 megohms minimum           |
| IP Rating.....   | IP 40.....                                     | IP 40                         |

\*RoHS Directive 2002/95/EC Jan. 27, 2003 including annex and RoHS Recast 2011/65/EU June 8, 2011.  
 Specifications are subject to change without notice.  
 Customers should verify actual device performance in their specific applications.

**Model 91, 92, 93, 94 & 95 - 5/8 " Square Single-Turn Panel Control** **BOURNS®**

**Mechanical Characteristics<sup>1</sup>**

|  |  |
|--|--|
| Stop Strength (1/4 " D shaft) .....            | 45.19 N-cm (4 lb.-in.)   |
| (1/8 " D shaft) .....                          | 33.89 N-cm (3 lb.-in.)   |
| Mechanical Angle.....                          | 300 ° ±5 °   |
| Torque   |  |
| Starting .....                                 | 0.3 max. above average running torque  |
| Running Torque                                 |  |
| Single or Dual Section (A & R Bushings) .....  | 0.21 to 1.06 N-cm (0.3 to 1.5 oz.-in.)   |
| Single or Dual Section (C & U Bushings) .....  | 0.14 to 1.06 N-cm (0.2 to 1.5 oz.-in.)   |
| Mounting .....                                 | 1.7-2.0 N-m (15-18 lb.-in.) maximum  |
| Variation.....                                 | 0.35 N-cm (0.5 oz.-in.) maximum in 45 ° shaft travel   |
| Weight (Single Section, Metal Bushing).....    | 12.7 grams nominal   |
| (Each Additional Section) .....                | 4 grams nominal  |
| Terminals .....                                | Printed circuit terminals, J-Hooks or solder lugs  |
| Soldering Condition .....                      | Recommended hand soldering using Sn95/Ag5 no clean solder, 0.025 " wire diameter.<br>Maximum temperature 399 °C (750 °F) for 3 seconds. No wash process to be used with no clean flux. |
| Marking .....                                  | Manufacturer's trademark, date code, resistance, manufacturer's part number  |
| Ganging (Multiple Section Potentiometers)..... | 2 cups maximum   |
| Hardware.....                                  | One lockwasher and one mounting nut is shipped with each potentiometer, except where noted in the part number.   |

NOTE: Performance specifications do not apply to units subjected to printed circuit board cleaning procedures.

<sup>1</sup>At room ambient: +25 °C nominal and 50 % relative humidity nominal, except as noted.

# Model 91, 92, 93, 94 & 95 - 5/8" Square Single-Turn Panel Control **BOURNS®**

## Product Dimensions

### Model 91 PC Pin Terminals, In-Line



### Model 92 J-Hooked Terminals, In-Line



### Model 94 J-Hooked Terminals, "L" Pattern



### Model 93 PC Pin Terminals, "L" Pattern



### Shaft Flat Orientation



### Model 95 Solder Lug Terminals, "Triangular" Pattern

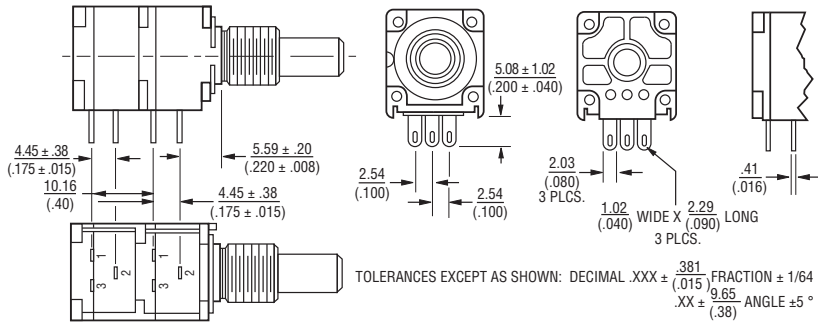

Specifications are subject to change without notice. Customers should verify actual device performance in their specific applications.

# Model 91, 92, 93, 94 & 95 - 5/8" Square Single-Turn Panel Control **BOURNS®**

## Product Dimensions

### Plastic Shaft Styles

**SHAFT TYPE "B"** (USES BUSHING A)

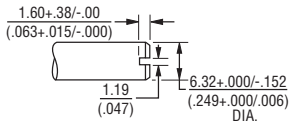

STD. LENGTHS:

|                 |                 |                 |                 |
|-----------------|-----------------|-----------------|-----------------|
| 12.70<br>(.500) | 15.88<br>(.625) | 19.05<br>(.750) | 22.23<br>(.875) |
|-----------------|-----------------|-----------------|-----------------|

**SHAFT TYPE "C"** (USES BUSHING A)

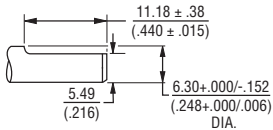

STD. LENGTHS:

|                 |                 |
|-----------------|-----------------|
| 19.05<br>(.750) | 22.23<br>(.875) |
|-----------------|-----------------|

**SHAFT TYPE "D"** (USES BUSHING C)

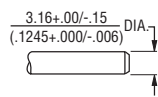

STD. LENGTHS:

|                 |                 |                 |
|-----------------|-----------------|-----------------|
| 12.70<br>(.500) | 15.88<br>(.625) | 19.05<br>(.750) |
|-----------------|-----------------|-----------------|

**SHAFT TYPE "T"** (USES BUSHING U)



STD. LENGTHS:

|                |                |
|----------------|----------------|
| 16.0<br>(.630) | 22.0<br>(.866) |
|----------------|----------------|

**SHAFT TYPE "R"** (USES BUSHING R)



STD. LENGTHS:

|                |                |
|----------------|----------------|
| 16.0<br>(.630) | 22.0<br>(.866) |
|----------------|----------------|

**SHAFT TYPE "W"** (USES BUSHING A)



STD. LENGTHS:

|                 |
|-----------------|
| 25.40<br>(1.00) |
|-----------------|

### Metal Shaft Styles

**SHAFT TYPE "A"** (USES BUSHING A)

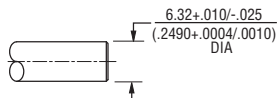

STD. LENGTHS:

|                 |                 |                 |                 |                 |
|-----------------|-----------------|-----------------|-----------------|-----------------|
| 12.70<br>(.500) | 15.88<br>(.625) | 19.05<br>(.750) | 22.23<br>(.875) | 25.4<br>(1.000) |
|-----------------|-----------------|-----------------|-----------------|-----------------|

**SHAFT TYPE "H"** (USES BUSHING A)

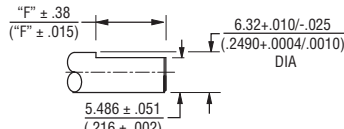

STD. LENGTHS:

|                 |                 |
|-----------------|-----------------|
| 19.05<br>(.750) | 22.23<br>(.875) |
|-----------------|-----------------|

FLAT LENGTH "F":

|                |                 |
|----------------|-----------------|
| 7.95<br>(.313) | 11.13<br>(.438) |
|----------------|-----------------|

**SHAFT TYPE "S"** (USES BUSHING R)

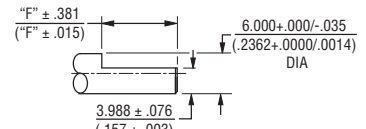

STD. LENGTHS:

|                 |                 |
|-----------------|-----------------|
| 19.05<br>(.750) | 22.23<br>(.875) |
|-----------------|-----------------|

FLAT LENGTH "F":

|                |                 |
|----------------|-----------------|
| 9.98<br>(.393) | 12.98<br>(.511) |
|----------------|-----------------|

**SHAFT TYPE "E"** (USES BUSHING C)



STD. LENGTHS:

|                |                |                |
|----------------|----------------|----------------|
| 12.0<br>(.500) | 16.0<br>(.625) | 19.0<br>(.750) |
|----------------|----------------|----------------|

**SHAFT TYPE "J"** (USES BUSHING R)



STD. LENGTHS:

|                |                |
|----------------|----------------|
| 16.0<br>(.630) | 22.0<br>(.866) |
|----------------|----------------|

**SHAFT TYPE "V"** (USES BUSHING U)

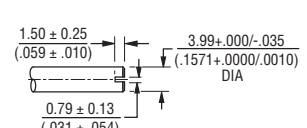

STD. LENGTHS:

|                 |                 |
|-----------------|-----------------|
| 19.05<br>(.750) | 22.23<br>(.875) |
|-----------------|-----------------|

**SHAFT TYPE "G"** (USES BUSHING A)

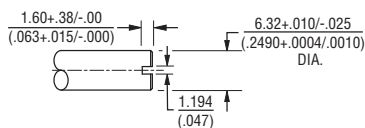

STD. LENGTHS:

|                 |                 |                 |                 |
|-----------------|-----------------|-----------------|-----------------|
| 12.70<br>(.500) | 15.88<br>(.625) | 19.05<br>(.750) | 22.23<br>(.875) |
|-----------------|-----------------|-----------------|-----------------|

TOLERANCES EXCEPT AS SHOWN: .XX = ± .02  
 (.050)  
 .XXX = ± .005  
 (.127)  
 .XXXX = ± .0005  
 (.0127)

DIMENSIONS:  $\frac{\text{MM}}{\text{(INCHES)}}$

# How to Order Model 91, 92, 93, 94 & 95 Panel Controls

# BOURNS®





Компания «ЭлектроПласт» предлагает заключение долгосрочных отношений при поставках импортных электронных компонентов на взаимовыгодных условиях!

Наши преимущества:

- Оперативные поставки широкого спектра электронных компонентов отечественного и импортного производства напрямую от производителей и с крупнейших мировых складов;
- Поставка более 17-ти миллионов наименований электронных компонентов;
- Поставка сложных, дефицитных, либо снятых с производства позиций;
- Оперативные сроки поставки под заказ (от 5 рабочих дней);
- Экспресс доставка в любую точку России;
- Техническая поддержка проекта, помощь в подборе аналогов, поставка прототипов;
- Система менеджмента качества сертифицирована по Международному стандарту ISO 9001;
- Лицензия ФСБ на осуществление работ с использованием сведений, составляющих государственную тайну;
- Поставка специализированных компонентов (Xilinx, Altera, Analog Devices, Intersil, Interpoint, Microsemi, Aeroflex, Peregrine, Syfer, Eurofarad, Texas Instrument, Miteq, Cobham, E2V, MA-COM, Hittite, Mini-Circuits, General Dynamics и др.);

Помимо этого, одним из направлений компании «ЭлектроПласт» является направление «Источники питания». Мы предлагаем Вам помощь Конструкторского отдела:

- Подбор оптимального решения, техническое обоснование при выборе компонента;
- Подбор аналогов;
- Консультации по применению компонента;
- Поставка образцов и прототипов;
- Техническая поддержка проекта;
- Защита от снятия компонента с производства.



#### Как с нами связаться

**Телефон:** 8 (812) 309 58 32 (многоканальный)

**Факс:** 8 (812) 320-02-42

**Электронная почта:** [org@eplast1.ru](mailto:org@eplast1.ru)

**Адрес:** 198099, г. Санкт-Петербург, ул. Калинина, дом 2, корпус 4, литера А.