



Features

- Available in a variety of pin-out configurations
- Virtually infinite electrical circuit isolation
- Metal or plastic shaft options
- RoHS compliant*

Model 91, 92, 93, 94 & 95 - 5/8" Square Single-Turn Panel Control

Initial Electrical Characteristics ¹	Conductive Plastic Element	Cermet Element
Standard Resistance Range		
Linear Tapers (A, B, E, & H).....	(B & E) 1 K ohms to 1 megohm.....	(A & H) 100 ohms to 1 megohm
Audio Tapers (C, D, F, G, S, & T).....	(D,G,S, & T) 1 K ohms to 1 megohm.....	(C & F) 1 K ohms to 1 megohm
Total Resistance Tolerance.....	10 % or 20 %.....	5% or 10%
Independent Linearity.....	±5 %.....	±5 %
Absolute Minimum Resistance.....	2 ohms maximum.....	2 ohms maximum
Effective Electrical Angle.....	(Linear tapers) 240 ° ± 5 °.....	(Linear tapers) 240 ° ± 6 °
	(Audio tapers) 225 ° ± 5 °.....	(Audio tapers) 225 ° ± 6 °
Contact Resistance Variation.....	±1 %.....	±1 % or 3 ohms (whichever is greater)
Dielectric Withstanding Voltage (MIL-STD-202, Method 301)		
Sea Level.....	1,500 VAC minimum.....	1,500 VAC minimum
70,000 Feet.....	500 VAC minimum.....	500 VAC minimum
Insulation Resistance (500 VDC).....	1,000 megohms minimum.....	1,000 megohms minimum
Power Rating (Voltage Limited By Power Dissipation or 350 VAC, Whichever Is Less)		
+70 °C Single Section Assembly.....	(Linear tapers) 1 watt.....	(Linear tapers) 2 watts
	(Audio tapers) 0.5 watt.....	(Audio tapers) 1 watt
+70 °C Multiple Section Assembly.....	(Linear tapers) 0.5 watt/section.....	(Linear tapers) 1 watt/section
	(Audio tapers) 0.25 watt/section.....	(Audio tapers) 0.5 watt/section
+125 °C.....	0 watt.....	0 watt
Theoretical Resolution.....	Essentially infinite.....	Essentially infinite

Environmental Characteristics ¹		
Operating Temperature Range.....	-40 °C to +125 °C.....	-40 °C to +125 °C
Storage Temperature Range.....	-55 °C to +125 °C.....	-55 °C to +125 °C
Temperature Coefficient Over Storage		
Temperature Range.....	±1,000 ppm/°C.....	±150 ppm/°C
Vibration (Single Section).....		
Total Resistance Shift.....	±2 % maximum.....	±2 % maximum
Voltage Ratio Shift.....	±5 % maximum.....	±5 % maximum
Shock (Single Section).....		
Total Resistance Shift.....	±2 % maximum.....	±2 % maximum
Voltage Ratio Shift.....	±5 % maximum.....	±5 % maximum
Load Life.....		
Total Resistance Shift.....	±10 % maximum.....	±5 % maximum
Rotational Life (No Load).....		
Total Resistance Shift.....	(Linear tapers) 10 ohms or ±15 % TRS max.	(All tapers) ±5 % TRS max.
	(whichever is greater)	
	(Audio tapers) ±20 % maximum	
Contact Resistance Variation		
@ 50,000 cycles.....	(Linear tapers) ±2 %.....	±2 %
	(Audio tapers) ±3 %.....	±3 %
Moisture Resistance (MIL-STD-202, Method 103, Condition B)		
Total Resistance Shift.....	(Linear tapers) ±10 % TRS maximum.....	(All tapers) ±5 % TRS maximum
	(Audio tapers) ±20 % TRS maximum	
Insulation Resistance (500 VDC).....	100 megohms minimum.....	100 megohms minimum
IP Rating.....	IP 40.....	IP 40

*RoHS Directive 2002/95/EC Jan. 27, 2003 including annex and RoHS Recast 2011/65/EU June 8, 2011.
 Specifications are subject to change without notice.
 Customers should verify actual device performance in their specific applications.

Model 91, 92, 93, 94 & 95 - 5/8 " Square Single-Turn Panel Control **BOURNS®**

Mechanical Characteristics¹

Stop Strength (1/4 " D shaft)	45.19 N-cm (4 lb.-in.)
(1/8 " D shaft)	33.89 N-cm (3 lb.-in.)
Mechanical Angle.....	300 ° ±5 °
Torque	
Starting	0.3 max. above average running torque
Running Torque	
Single or Dual Section (A & R Bushings)	0.21 to 1.06 N-cm (0.3 to 1.5 oz.-in.)
Single or Dual Section (C & U Bushings)	0.14 to 1.06 N-cm (0.2 to 1.5 oz.-in.)
Mounting	1.7-2.0 N-m (15-18 lb.-in.) maximum
Variation.....	0.35 N-cm (0.5 oz.-in.) maximum in 45 ° shaft travel
Weight (Single Section, Metal Bushing).....	12.7 grams nominal
(Each Additional Section)	4 grams nominal
Terminals	Printed circuit terminals, J-Hooks or solder lugs
Soldering Condition	Recommended hand soldering using Sn95/Ag5 no clean solder, 0.025 " wire diameter. Maximum temperature 399 °C (750 °F) for 3 seconds. No wash process to be used with no clean flux.
Marking	Manufacturer's trademark, date code, resistance, manufacturer's part number
Ganging (Multiple Section Potentiometers).....	2 cups maximum
Hardware.....	One lockwasher and one mounting nut is shipped with each potentiometer, except where noted in the part number.

NOTE: Performance specifications do not apply to units subjected to printed circuit board cleaning procedures.

¹At room ambient: +25 °C nominal and 50 % relative humidity nominal, except as noted.

Model 91, 92, 93, 94 & 95 - 5/8" Square Single-Turn Panel Control **BOURNS®**

Product Dimensions

Model 91 PC Pin Terminals, In-Line



Model 92 J-Hooked Terminals, In-Line



Model 94 J-Hooked Terminals, "L" Pattern

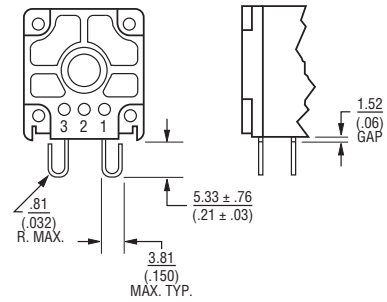

Model 93 PC Pin Terminals, "L" Pattern

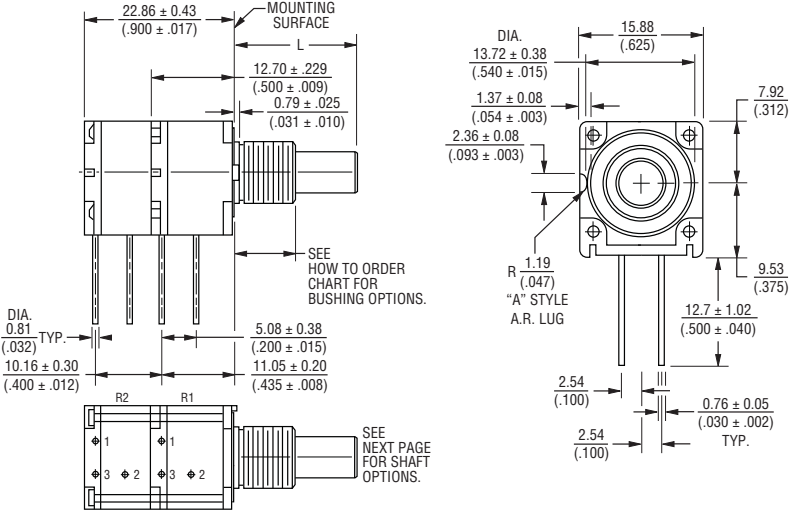

Shaft Flat Orientation

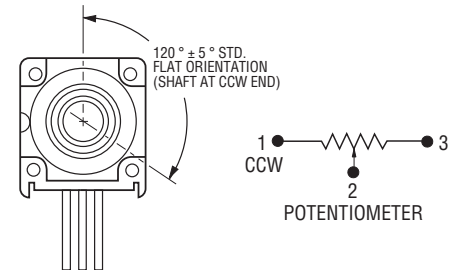

Model 95 Solder Lug Terminals, "Triangular" Pattern

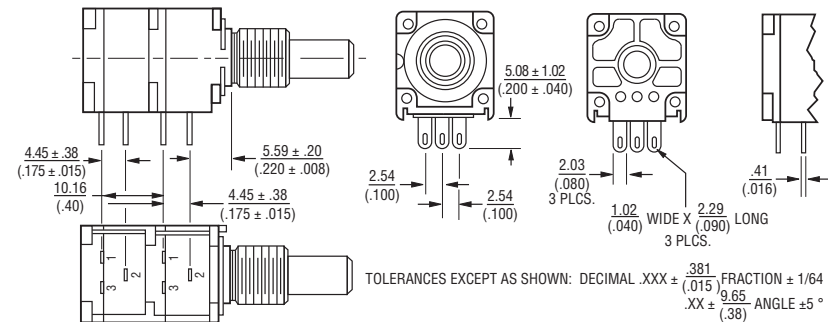

Specifications are subject to change without notice. Customers should verify actual device performance in their specific applications.

Model 91, 92, 93, 94 & 95 - 5/8" Square Single-Turn Panel Control **BOURNS®**

Product Dimensions

Plastic Shaft Styles

SHAFT TYPE "B" (USES BUSHING A)



STD. LENGTHS:

12.70 (.500)	15.88 (.625)	19.05 (.750)	22.23 (.875)
-----------------	-----------------	-----------------	-----------------

SHAFT TYPE "C" (USES BUSHING A)

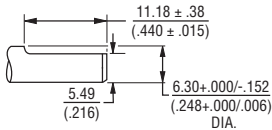

STD. LENGTHS:

19.05 (.750)	22.23 (.875)
-----------------	-----------------

SHAFT TYPE "D" (USES BUSHING C)

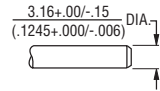

STD. LENGTHS:

12.70 (.500)	15.88 (.625)	19.05 (.750)
-----------------	-----------------	-----------------

SHAFT TYPE "T" (USES BUSHING U)

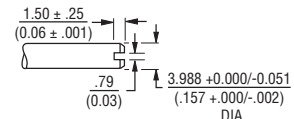

STD. LENGTHS:

16.0 (.630)	22.0 (.866)
----------------	----------------

SHAFT TYPE "R" (USES BUSHING R)

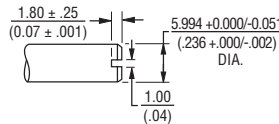

STD. LENGTHS:

16.0 (.630)	22.0 (.866)
----------------	----------------

SHAFT TYPE "W" (USES BUSHING A)

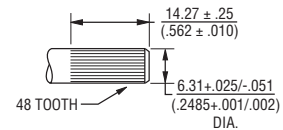

STD. LENGTHS:

25.40 (1.00)

Metal Shaft Styles

SHAFT TYPE "A" (USES BUSHING A)

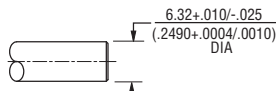

STD. LENGTHS:

12.70 (.500)	15.88 (.625)	19.05 (.750)	22.23 (.875)	25.4 (1.000)
-----------------	-----------------	-----------------	-----------------	-----------------

SHAFT TYPE "E" (USES BUSHING C)

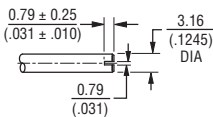

STD. LENGTHS:

12.0 (.500)	16.0 (.625)	19.0 (.750)
----------------	----------------	----------------

SHAFT TYPE "G" (USES BUSHING A)

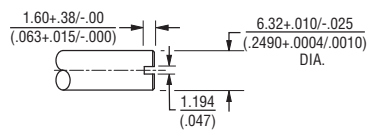

STD. LENGTHS:

12.70 (.500)	15.88 (.625)	19.05 (.750)	22.23 (.875)
-----------------	-----------------	-----------------	-----------------

SHAFT TYPE "H" (USES BUSHING A)

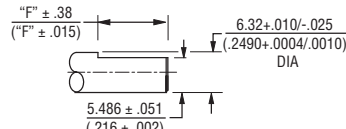

STD. LENGTHS:

19.05 (.750)	22.23 (.875)
-----------------	-----------------

FLAT LENGTH "F":

7.95 (.313)	11.13 (.438)
----------------	-----------------

SHAFT TYPE "S" (USES BUSHING R)

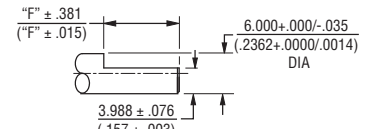

STD. LENGTHS:

19.05 (.750)	22.23 (.875)
-----------------	-----------------

FLAT LENGTH "F":

9.98 (.393)	12.98 (.511)
----------------	-----------------

SHAFT TYPE "J" (USES BUSHING R)

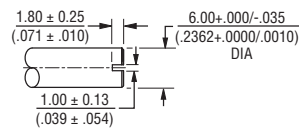

STD. LENGTHS:

16.0 (.630)	22.0 (.866)
----------------	----------------

SHAFT TYPE "V" (USES BUSHING U)

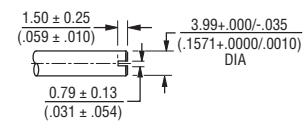

STD. LENGTHS:

19.05 (.750)	22.23 (.875)
-----------------	-----------------

TOLERANCES EXCEPT AS SHOWN: .XX = ± .02
 (.050)
 .XXX = ± .005
 (.127)
 .XXXX = ± .0005
 (.0127)

DIMENSIONS: $\frac{\text{MM}}{\text{(INCHES)}}$

How to Order Model 91, 92, 93, 94 & 95 Panel Controls

BOURNS®





Компания «ЭлектроПласт» предлагает заключение долгосрочных отношений при поставках импортных электронных компонентов на взаимовыгодных условиях!

Наши преимущества:

- Оперативные поставки широкого спектра электронных компонентов отечественного и импортного производства напрямую от производителей и с крупнейших мировых складов;
- Поставка более 17-ти миллионов наименований электронных компонентов;
- Поставка сложных, дефицитных, либо снятых с производства позиций;
- Оперативные сроки поставки под заказ (от 5 рабочих дней);
- Экспресс доставка в любую точку России;
- Техническая поддержка проекта, помощь в подборе аналогов, поставка прототипов;
- Система менеджмента качества сертифицирована по Международному стандарту ISO 9001;
- Лицензия ФСБ на осуществление работ с использованием сведений, составляющих государственную тайну;
- Поставка специализированных компонентов (Xilinx, Altera, Analog Devices, Intersil, Interpoint, Microsemi, Aeroflex, Peregrine, Syfer, Eurofarad, Texas Instrument, Miteq, Cobham, E2V, MA-COM, Hittite, Mini-Circuits, General Dynamics и др.);

Помимо этого, одним из направлений компании «ЭлектроПласт» является направление «Источники питания». Мы предлагаем Вам помощь Конструкторского отдела:

- Подбор оптимального решения, техническое обоснование при выборе компонента;
- Подбор аналогов;
- Консультации по применению компонента;
- Поставка образцов и прототипов;
- Техническая поддержка проекта;
- Защита от снятия компонента с производства.



Как с нами связаться

Телефон: 8 (812) 309 58 32 (многоканальный)

Факс: 8 (812) 320-02-42

Электронная почта: org@eplast1.ru

Адрес: 198099, г. Санкт-Петербург, ул. Калинина, дом 2, корпус 4, литера А.