

# MLV Series Low Voltage Pressure Sensors



## Features

- 1 to 30 inH2O & 5 to 150 PSI Pressure Ranges
- 5V Operation
- High Output
- Low Power Consumption
- Excellent Position Sensitivity
- Low Warm-Up Shift
- Enhanced Front to Back Linearity
- Protective Parylene Coating Option

## Applications

- Medical Breathing
- Environmental Controls
- HVAC
- Industrial Controls
- Portable/Hand-Held Equipment

## General Description

The MLV Series Compensated Sensor is based on All Sensors' CoBeam<sup>2</sup>™ Technology. The device provides a high output signal at a low operating voltage while maintaining comparable output levels to traditional equivalent compensated millivolt sensors operating at higher voltages. This lower supply voltage gives rise to improved warm-up shift while the CoBeam<sup>2</sup> Technology itself reduces package stress susceptibility resulting in improved overall long term stability. The technology also vastly improves position sensitivity compared to conventional single die devices.

These calibrated and compensated sensors give an accurate and stable output over a wide temperature range. This series is intended for use with non-corrosive, non-ionic working fluids such as air, dry gases and the like. A protective parylene coating is optionally available for moisture/harsh media protection. The output is also ratiometric to the supply voltage and designed to operate at 5.0 volts DC.

| Standard Pressure Ranges |                 |                |                |              | Equivalent Circuit |
|--------------------------|-----------------|----------------|----------------|--------------|--------------------|
| Device                   | Operating Range | Proof Pressure | Burst Pressure | Nominal Span |                    |
| MLV-L01D                 | ±1 inH2O        | 100 inH2O      | 300 inH2O      | 7 mV         |                    |
| MLV-L02D                 | ±2 inH2O        | 100 inH2O      | 300 inH2O      | 10 mV        |                    |
| MLV-L05D                 | ±5 inH2O        | 200 inH2O      | 300 inH2O      | 15 mV        |                    |
| MLV-L10D                 | ±10 inH2O       | 200 inH2O      | 300 inH2O      | 20 mV        |                    |
| MLV-L20D                 | ±20 inH2O       | 200 inH2O      | 500 inH2O      | 20 mV        |                    |
| MLV-L30D                 | ±30 inH2O       | 200 inH2O      | 800 inH2O      | 20 mV        |                    |
| MLV-005D                 | ±5 PSI          | 10 PSI         | 30PSI          | 25 mV        |                    |
| MLV-015D                 | ±15 PSI         | 60 PSI         | 120 PSI        | 37.5 mV      |                    |
| MLV-015A                 | 0 - 15 PSIA     | 60 PSI         | 120 PSI        | 37.5 mV      |                    |
| MLV-030D                 | ±30 PSI         | 90 PSI         | 150 PSI        | 37.5 mV      |                    |
| MLV-100D                 | ±100 PSI        | 200 PSI        | 250 PSI        | 41.67 mV     |                    |
| MLV-150D                 | ±150 PSI        | 200 PSI        | 250 PSI        | 37.5 mV      |                    |



| Pressure Sensor Maximum Ratings              |         | Environmental Specifications |                                 |
|--|---------|------------------------------|---------------------------------|
| Supply Voltage (Vs)                          | 12 Vdc  | Temperature Ranges           |                                 |
| Common Mode Pressure                         |         | Compensated                  | 0°C to 50°C                     |
| InH2O Devices (L01, L02, L05, L10, L20, L30) | 10 psig | Operating                    | -25°C to 85 °C                  |
| PSI Devices (005, 015, 030, 100, 150)        | 50 psig | Storage                      | -40°C to 125 °C                 |
| Lead Temperature (soldering 2-4 sec.)        | 270 °C  | Humidity Limits              | 0 to 95% RH<br>(non condensing) |

### Performance Characteristics for MLV Series (InH2O)

ALL PARAMETERS ARE MEASURED AT 5.0 VOLT EXCITATION AND ROOM TEMPERATURE UNLESS OTHERWISE SPECIFIED. PRESSURE MEASUREMENTS ARE WITH POSITIVE PRESSURE APPLIED TO PORT B (THE ONLY PORT FOR THE SINGLE PORT CONFIGURATION PACKAGES).

| Parameter                                     | Min  | Typ  | Max   | Units | Notes |
|---|------|------|-------|-------|-------|
| <b>Output Span</b>                            |      |      |       |       |       |
| L01D @ 1 inH2O                                | 6.0  | 7.0  | 8.0   | mV    | 4     |
| L02D @ 2 inH2O                                | 9.0  | 10.0 | 11.0  | mV    | 4     |
| L05D @ 5 inH2O                                | 14.0 | 15.0 | 16.0  | mV    | 4     |
| L10D @ 10 inH2O                               | 19.0 | 20.0 | 21.0  | mV    | 4     |
| L20D @ 20 inH2O                               | 19.0 | 20.0 | 21.0  | mV    | 4     |
| L30D @ 30 inH2O                               | 19.0 | 20.0 | 21.0  | mV    | 4     |
| Span Temperature Shift (0°C to 50°C)          | -    | -    | ±250  | uV    | 1     |
| Offset Voltage @ Zero Diff. Pressure          | -    | -    | ±500  | uV    | -     |
| <b>Offset Temperature Shift (0°C to 50°C)</b> |      |      |       |       |       |
| L01D, L02D, L05D                              | -    | -    | ±250  | uV    | 1     |
| L10D, L20D, L30D                              | -    | -    | ±200  | uV    | 1     |
| Offset Warm-up Shift                          | -    | -    | ±50.0 | uV    | 2     |
| <b>Offset Position Sensitivity (1g)</b>       |      |      |       |       |       |
| L01D  | -    | -    | ±20.0 | uV    | 6     |
| L02D  | -    | -    | ±15.0 | uV    | 6     |
| L05D, L10D, L20D, L30D                        | -    | -    | ±10.0 | uV    | 6     |
| <b>Offset Long Term Drift (One Year)</b>      |      |      |       |       |       |
| L01D, L02D, L05D                              | -    | ±150 | -     | uV    | -     |
| L10D, L20D, L30D                              | -    | ±100 | -     | uV    | -     |
| Linearity, Hysteresis Error                   | -    | 0.10 | 0.30  | %FSS  | 3     |
| Response Time (10% to 90% Pressure Response)  | -    | 500  | -     | us    | -     |
| Front to Back Linearity                       | -    | 0.75 | -     | %FSS  | 5     |
| Input Resistance                              | -    | 12.0 | -     | k ohm | -     |
| Output Resistance                             | -    | 3.0  | -     | k ohm | -     |

## Performance Characteristics for MLV Series (PSI)

ALL PARAMETERS ARE MEASURED AT 5.0 VOLT EXCITATION AND ROOM TEMPERATURE UNLESS OTHERWISE SPECIFIED. PRESSURE MEASUREMENTS ARE WITH POSITIVE PRESSURE APPLIED TO PORT B (THE ONLY PORT FOR THE SINGLE PORT CONFIGURATION PACKAGES). PRESSURE IS APPLIED TO PORT A FOR ABSOLUTE DEVICES IN A-PACKAGE.

| Parameter                                    | Min   | Typ   | Max   | Units | Notes |
|--|-------|-------|-------|-------|-------|
| <b>Output Span</b>                           |       |       |       |       |       |
| 005D @ 5 PSI                                 | 24.75 | 25.0  | 25.25 | mV    | 4     |
| 015D @ 15 PSI                                | 37.13 | 37.50 | 37.88 | mV    | 4     |
| 015A @ 15 PSIA                               | 37.13 | 37.50 | 37.88 | mV    | 4     |
| 030D @ 30 PSI                                | 37.13 | 37.50 | 37.88 | mV    | 4     |
| 100D @ 100 PSI                               | 41.25 | 41.67 | 42.08 | mV    | 4     |
| 150D @ 150 PSI                               | 37.08 | 37.50 | 37.92 | mV    | 4     |
| Span Temperature Shift (0°C to 50°C)         | -     | -     | ±1.0  | %FSS  | 1     |
| <b>Offset Voltage @ Zero Diff. Pressure</b>  |       |       |       |       |       |
| 005D @ 5 PSI                                 | -     | -     | 125   | uV    | -     |
| 015D @ 15 PSI                                | -     | -     | 125   | uV    | -     |
| 015A @ 15 PSIA                               | -     | -     | 208   | uV    | -     |
| 030D @ 30 PSI                                | -     | -     | 125   | uV    | -     |
| 100D @ 100 PSI                               | -     | -     | 125   | uV    | -     |
| 150D @ 150 PSI                               | -     | -     | 125   | uV    | -     |
| Offset Warm-Up Shift                         | -     | ±20   | -     | uV    | 2     |
| Offset Long Term Drift (one year)            | -     | ±100  | -     | uV    | -     |
| Linearity, Hysteresis Error                  | -     | 0.20  | 0.50  | %FSS  | 3     |
| Response Time (10% to 90% Pressure Response) | -     | 500   | -     | us    | -     |
| Front to Back Linearity                      | -     | 2.5   | -     | %FSS  | 5     |
| Input Resistance                             | -     | 12.0  | -     | k ohm | -     |
| Output Resistance                            | -     | 3.0   | -     | k ohm | -     |

### Specification Notes

NOTE 1: SHIFT IS RELATIVE TO 25°C.

NOTE 2: SHIFT IS WITHIN THE FIRST HOUR OF EXCITATION APPLIED TO THE DEVICE.

NOTE 3: MEASURED AT ONE-HALF FULL SCALE RATED PRESSURE USING BEST STRAIGHT LINE CURVE FIT.

NOTE 4: THE SPAN IS THE ALGEBRAIC DIFFERENCE BETWEEN FULL SCALE OUTPUT VOLTAGE AND THE OFFSET VOLTAGE.

NOTE 5: FRONT-BACK LINEARITY COMPUTED AS: 
$$\text{Lin}_{FB} = \left( \left| \frac{\text{Span}_{\text{Front}}}{\text{Span}_{\text{Back}}} \right| - 1 \right) \cdot 100\%$$

NOTE 6: PARAMETER IS CHARACTERIZED AND NOT 100% TESTED.



## How To Order

### A Package

Example: MLV-L02D-A6BBF-N

MLV--A6-

**Pressure Range**

| Option | Description |
|--------|-------------|
| L01D   | 1 in H2O    |
| L02D   | 2 in H2O    |
| L05D   | 5 in H2O    |
| L10D   | 10 in H2O   |
| L20D   | 20 in H2O   |
| L30D   | 30 in H2O   |
| 005D   | 5 PSI       |
| 015D   | 15 PSI      |
| 015A   | 15 PSIA     |
| 030D   | 30 PSI      |
| 100D   | 100 PSI     |
| 150D   | 150 PSI     |

**Series**

**Port Cut Configuration**

| Option | Description             |
|--------|-------------------------|
| A      | No Port Cut             |
| B      | Two Ports Cut 0.085"    |
| C      | Two Ports Cut 0.100"    |
| D      | Two Ports Cut 0.150"    |
| E      | One Port (A) Cut 0.080" |
| F      | One Port (A) Cut 0.370" |

**Port Fittings**

| Option | Description               |
|--------|---------------------------|
| A      | No Fittings               |
| B      | Barb Fitting Port A Only  |
| C      | Barb Fitting Port B Only  |
| D      | Barb Fittings Ports A & B |

**Coating**

| Option | Description      |
|--------|------------------|
| N      | No Coating       |
| P      | Parylene Coating |

(See NOTE 1 below)

**Lead Configuration**

| Option | Description        |
|--------|--------------------|
| F      | Flat (Straight)    |
| Q      | Right Angle 0.075" |
| R      | Right Angle 0.100" |
| J      | Jogged Bend        |

### E Package

Example: MLV-L02D-E1ND-N

MLV--E-

**Pressure Range**

| Option | Description |
|--------|-------------|
| L01D   | 1 in H2O    |
| L02D   | 2 in H2O    |
| L05D   | 5 in H2O    |
| L10D   | 10 in H2O   |
| L20D   | 20 in H2O   |
| L30D   | 30 in H2O   |
| 005D   | 5 PSI       |
| 015D   | 15 PSI      |
| 015A   | 15 PSIA     |
| 030D   | 30 PSI      |

**Series**

**Port Orientation**

| Option | Description             |
|--------|-------------------------|
| 1      | Dual Port Same Side     |
| 2      | Dual Port Opposite Side |
| G      | Single Port (Gage)      |

**Lid Style**

| Option | Description |
|--------|-------------|
| N      | Non-Barbed  |
| B      | Barbed      |

**Coating**

| Option | Description      |
|--------|------------------|
| N      | No Coating       |
| P      | Parylene Coating |

**Lead Type**

| Option | Description     |
|--------|-----------------|
| S      | SIP             |
| D      | DIP             |
| J      | J-Lead SMT      |
| L      | Low Profile DIP |

TABLE 1: Available E-Series Package Configurations

| Port Orientation        | Non-Barbed Lid Lead Style   |   |   |   | Barbed Lid Lead Style   |   |   |   |
|-------------------------|---|---|---|---|---|---|---|---|
|                         | SIP   | DIP   | J Lead SMT  | Low Profile DIP   | SIP   | DIP   | J Lead SMT  | Low Profile DIP   |
| Dual Port Same Side     | <br>E1NS | <br>E1ND | <br>E1NJ | N/A   | <br>E1BS | <br>E1BD | N/A   | N/A   |
| Dual Port Opposite Side | <br>E2NS | <br>E2ND | <br>E2NJ | N/A   | <br>E2BS | <br>E2BD | N/A   | N/A   |
| Single Port (Gage)      | <br>EGNS | <br>EGND | <br>EGNJ | <br>EGNL | <br>EGBS | <br>EGBD | <br>EGBJ | <br>EGBL |

NOTE 1) Parylene Coating: Parylene coating provides a moisture barrier and protection from some harsh media. Consult factory for applicability of Parylene for the target application and sensor type.

# Package Drawings

## A6 Package (Without Options)



| Pinout  | Pinout     |
|---------|------------|
| (Gage)  | (Absolute) |
| 1) N/C  | 1) N/C     |
| 2) Vs   | 2) Vs      |
| 3) +Out | 3) -Out    |
| 4) Gnd  | 4) Gnd     |
| 5) -Out | 5) +Out    |
| 6) N/C  | 6) N/C     |

NOTES  
 1) Dimensions are in inches [mm].  
 2) For suggested pad layout, see drawing: PAD-09

## A-Package: Port Cut Options

Example: MLV-L10D-A6xAF-N

### Port Cut Options



A- No Port Cut Configuration



D- Two Ports Cut 0.150" Configuration



B- Two Ports Cut 0.085" Configuration



E- Port A cut 0.080" Configuration



C- Two Ports Cut 0.100" Configuration



F- Port A Cut 0.370" Configuration



A-Package: Port Fitting Options

Example: MLV-L10D-A6DxF-N

Port Fitting Options

NOTE: Port Cut Configuration "D" Shown As Reference.



A- No Fittings Configuration



C- Barb Fitting Port B Only Configuration



B- Barb Fitting Port A Only Configuration



D- Barb Fitting Ports A and B Configuration

A-Package: Lead Bend Options

Example: MLV-L10D-A6AAx-N

Lead Bend Options



F- Flat (Straight) Configuration



R- Right Angle 0.100" Configuration



J- Jogged Bend Configuration



Q- Right Angle 0.075" Configuration

## E1NS Package

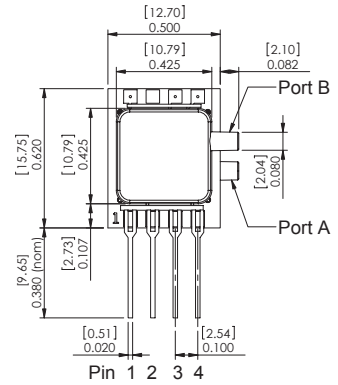
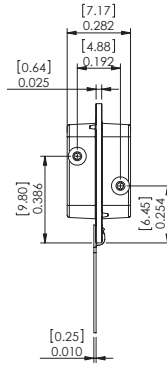

### Pinout

- 1) Gnd
- 2) +Out
- 3) Vs
- 4) -Out

### NOTES

- 1) Dimensions are in inches [mm]
- 2) For suggested pad layout, see drawing: PAD-01

## E1BS Package

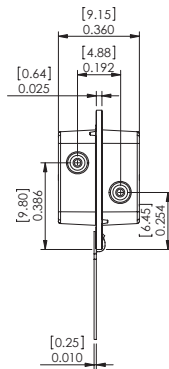

### Pinout

- 1) Gnd
- 2) +Out
- 3) Vs
- 4) -Out

### NOTES

- 1) Dimensions are in inches [mm]
- 2) For suggested pad layout, see drawing: PAD-01



## E2NS Package



### Pinout

- 1) Gnd
- 2) +Out
- 3) Vs
- 4) -Out

### NOTES

- 1) Dimensions are in inches [mm]
- 2) For suggested pad layout, see drawing: PAD-01

## E2BS Package



### Pinout

- 1) Gnd
- 2) +Out
- 3) Vs
- 4) -Out

### NOTES

- 1) Dimensions are in inches [mm]
- 2) For suggested pad layout, see drawing: PAD-01



### EGNS Package



NOTES  
 1) Dimensions are in inches [mm]  
 2) For suggested pad layout, see drawing: PAD-01

### EGBS Package

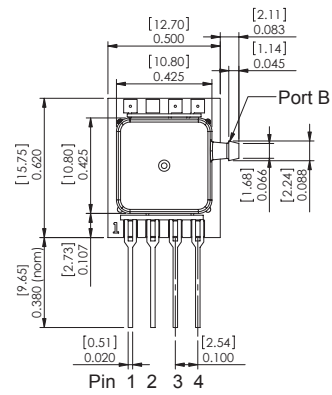
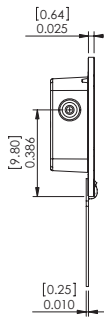
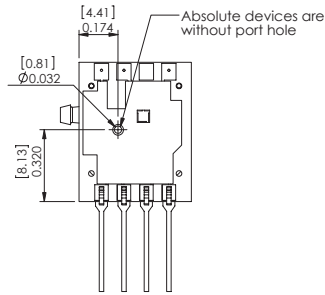
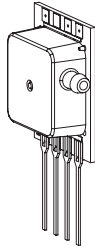

NOTES  
 1) Dimensions are in inches [mm]  
 2) For suggested pad layout, see drawing: PAD-01



## E1ND Package

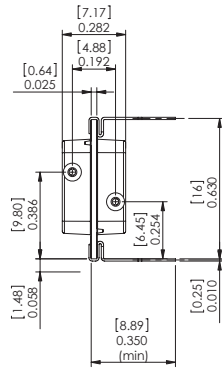

### Pinout

- 1) Gnd
- 2) +Out
- 3) Vs
- 4) -Out
- 5) Do Not Connect
- 6) Do Not Connect
- 7) Do Not Connect
- 8) Do Not Connect



### NOTES

- 1) Dimensions are in inches [mm]
- 2) For suggested pad layout, see drawing: PAD-03

## E1BD Package



### Pinout

- 1) Gnd
- 2) +Out
- 3) Vs
- 4) -Out
- 5) Do Not Connect
- 6) Do Not Connect
- 7) Do Not Connect
- 8) Do Not Connect



### NOTES

- 1) Dimensions are in inches [mm]
- 2) For suggested pad layout, see drawing: PAD-03

### E2ND Package



- Pinout**
- 1) Gnd
  - 2) +Out
  - 3) Vs
  - 4) -Out
  - 5) Do Not Connect
  - 6) Do Not Connect
  - 7) Do Not Connect
  - 8) Do Not Connect



- NOTES**
- 1) Dimensions are in inches [mm]
  - 2) For suggested pad layout, see drawing: PAD-03

### E2BD Package



- Pinout**
- 1) Gnd
  - 2) +Out
  - 3) Vs
  - 4) -Out
  - 5) Do Not Connect
  - 6) Do Not Connect
  - 7) Do Not Connect
  - 8) Do Not Connect



- NOTES**
- 1) Dimensions are in inches [mm]
  - 2) For suggested pad layout, see drawing: PAD-03



## EGND Package



### Pinout

- 1) Gnd
- 2) +Out
- 3) Vs
- 4) -Out
- 5) Do Not Connect
- 6) Do Not Connect
- 7) Do Not Connect
- 8) Do Not Connect



Pin 8 7 6 5



Pin 1 2 3 4

### NOTES

- 1) Dimensions are in inches [mm]
- 2) For suggested pad layout, see drawing: PAD-03

## EGBD Package



### Pinout

- 1) Gnd
- 2) +Out
- 3) Vs
- 4) -Out
- 5) Do Not Connect
- 6) Do Not Connect
- 7) Do Not Connect
- 8) Do Not Connect



Pin 8 7 6 5



Pin 1 2 3 4

### NOTES

- 1) Dimensions are in inches [mm]
- 2) For suggested pad layout, see drawing: PAD-03

### E1NJ Package



**DETAIL A**  
SCALE 4 : 1



**A**



#### Pinout

- 1) Gnd
- 2) +Out
- 3) Vs
- 4) -Out
- 5) Do Not Connect
- 6) Do Not Connect
- 7) Do Not Connect
- 8) Do Not Connect

#### NOTES

- 1) Dimensions are in inches [mm]
- 2) For suggested pad layout, see drawing: PAD-10

### E2NJ Package



**DETAIL A**  
SCALE 4 : 1



**A**



#### Pinout

- 1) Gnd
- 2) +Out
- 3) Vs
- 4) -Out
- 5) Do Not Connect
- 6) Do Not Connect
- 7) Do Not Connect
- 8) Do Not Connect

#### NOTES

- 1) Dimensions are in inches [mm]
- 2) For suggested pad layout, see drawing: PAD-10



### EGNJ Package



DETAIL A  
SCALE 4 : 1

#### Pinout

- 1) Gnd
- 2) +Out
- 3) Vs
- 4) -Out
- 5) Do Not Connect
- 6) Do Not Connect
- 7) Do Not Connect
- 8) Do Not Connect



A



#### NOTES

- 1) Dimensions are in inches [mm]
- 2) For suggested pad layout, see drawing: PAD-10

### EGBJ Package



DETAIL A  
SCALE 4 : 1

#### Pinout

- 1) Gnd
- 2) +Out
- 3) Vs
- 4) -Out
- 5) Do Not Connect
- 6) Do Not Connect
- 7) Do Not Connect
- 8) Do Not Connect



A



#### NOTES

- 1) Dimensions are in inches [mm]
- 2) For suggested pad layout, see drawing: PAD-10

### EGNL Package



Pin 8 7 6 5



Pin 1 2 3 4

#### Pinout

- 1) Gnd
- 2) +Out
- 3) Vs
- 4) -Out
- 5) Do Not Connect
- 6) Do Not Connect
- 7) Do Not Connect
- 8) Do Not Connect

#### NOTES

- 1) Dimensions are in inches [mm]
- 2) For suggested pad layout, see drawing: PAD-03

### EGBL Package



Pin 8 7 6 5

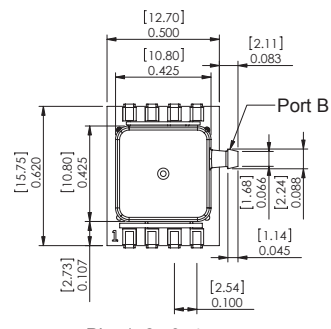

Pin 1 2 3 4

#### Pinout

- 1) Gnd
- 2) +Out
- 3) Vs
- 4) -Out
- 5) Do Not Connect
- 6) Do Not Connect
- 7) Do Not Connect
- 8) Do Not Connect

#### NOTES

- 1) Dimensions are in inches [mm]
- 2) For suggested pad layout, see drawing: PAD-03



## Suggested Pad Layout



## Package Characteristics

| Package ID | Approximate Port Volume |        |                 |       | Weight | Units | Notes |
|------------|-------------------------|--------|-----------------|-------|--------|-------|-------|
|            | Port A                  | Port B | Units           | Notes |        |       |       |
| A6AAx      | 132                     | 33.6   | mm <sup>3</sup> | 1     | 9.3    | Grams | 2     |
| A6BAx      | 119                     | 20.3   | mm <sup>3</sup> | 1     | 8.7    | Grams | 2     |
| A6CAx      | 119                     | 20.5   | mm <sup>3</sup> | 1     | 8.8    | Grams | 2     |
| A6DAx      | 120                     | 21.3   | mm <sup>3</sup> | 1     | 8.8    | Grams | 2     |
| A6EAx      | 119                     | 33.6   | mm <sup>3</sup> | 1     | 8.9    | Grams | 2     |
| A6FAx      | 125                     | 33.6   | mm <sup>3</sup> | 1     | 9.2    | Grams | 2     |
| E1Nx       | 174                     | 168    | mm <sup>3</sup> | -     | 1.2    | Grams | -     |
| E2Nx       | 174                     | 168    | mm <sup>3</sup> | -     | 1.2    | Grams | -     |
| EGNx       | 1.4                     | 168    | mm <sup>3</sup> | -     | 0.9    | Grams | -     |

### Package Notes

Note 1: Add 4.5 mm<sup>3</sup> per port with barb fitting.

Note 2: Add 0.15 gram per barb fitting.

## Product Labeling



Example Device Label

\* 5 PSI to 150 PSI devices may not be assembled with CoBeam<sup>2</sup>™ Technology.

All Sensors reserves the right to make changes to any products herein. All Sensors does not assume any liability arising out of the application or use of any product or circuit described herein, neither does it convey any license under its patent rights nor the rights of others.





Компания «ЭлектроПласт» предлагает заключение долгосрочных отношений при поставках импортных электронных компонентов на взаимовыгодных условиях!

Наши преимущества:

- Оперативные поставки широкого спектра электронных компонентов отечественного и импортного производства напрямую от производителей и с крупнейших мировых складов;
- Поставка более 17-ти миллионов наименований электронных компонентов;
- Поставка сложных, дефицитных, либо снятых с производства позиций;
- Оперативные сроки поставки под заказ (от 5 рабочих дней);
- Экспресс доставка в любую точку России;
- Техническая поддержка проекта, помощь в подборе аналогов, поставка прототипов;
- Система менеджмента качества сертифицирована по Международному стандарту ISO 9001;
- Лицензия ФСБ на осуществление работ с использованием сведений, составляющих государственную тайну;
- Поставка специализированных компонентов (Xilinx, Altera, Analog Devices, Intersil, Interpoint, Microsemi, Aeroflex, Peregrine, Syfer, Eurofarad, Texas Instrument, Miteq, Cobham, E2V, MA-COM, Hittite, Mini-Circuits, General Dynamics и др.);

Помимо этого, одним из направлений компании «ЭлектроПласт» является направление «Источники питания». Мы предлагаем Вам помощь Конструкторского отдела:

- Подбор оптимального решения, техническое обоснование при выборе компонента;
- Подбор аналогов;
- Консультации по применению компонента;
- Поставка образцов и прототипов;
- Техническая поддержка проекта;
- Защита от снятия компонента с производства.



#### Как с нами связаться

**Телефон:** 8 (812) 309 58 32 (многоканальный)

**Факс:** 8 (812) 320-02-42

**Электронная почта:** [org@eplast1.ru](mailto:org@eplast1.ru)

**Адрес:** 198099, г. Санкт-Петербург, ул. Калинина, дом 2, корпус 4, литера А.