

**PKU 5\$00E series DC/DC Converters**  
 Input 18 - 72 V, Output up to 10 A / 35 W

EN/LZT 146 391 R5A September 2017

© Flex

### Key Features

- Industry standard Sixteenth-brick  
 33.02 x 22.86 x 7.50 mm (1.3 x 0.9 x 0.295 in.)
- Wide Input range 18-72 V<sub>in</sub>
- High efficiency, typ. 91.7 % at 5 V half load & 27 V<sub>in</sub>
- 1500 V<sub>dc</sub> input to output isolation
- Surface mount option
- Meets safety requirements according to IEC/EN/UL 60950-1
- MTBF 4.2 million hours



### General Characteristics

- Input under voltage protection
- Over temperature protection
- Output over voltage protection
- Output short circuit protection
- Remote control
- Highly automated manufacturing ensures quality
- ISO 9001/14001 certified supplier

#### Safety Approvals



#### Design for Environment



**RoHS**  
 compliant ✓

Meets requirements in high-temperature lead-free soldering processes.

### Contents

|                                      |       |                       |
|--------------------------------------|-------|-----------------------|
| General Information                  | ..... | 2                     |
| Safety Specification                 | ..... | 3                     |
| Absolute Maximum Ratings             | ..... | 4                     |
| Product Program                      |       |                       |
| 3.3 V/10 A Electrical Specification  |       | Ordering No.          |
| 5 V/7 A Electrical Specification     |       | PKU 5310E PI ..... 5  |
| 12 V/2,75 A Electrical Specification |       | PKU 5311E PI ..... 8  |
| 15 V/2 A Electrical Specification    |       | PKU 5313E PI ..... 11 |
|                                      |       | PKU 5315E PI ..... 14 |
| EMC Specification                    | ..... | 17                    |
| Operating Information                | ..... | 18                    |
| Thermal Consideration                | ..... | 20                    |
| Connections                          | ..... | 20                    |
| Mechanical Information               | ..... | 21                    |
| Soldering Information                | ..... | 23                    |
| Delivery Package Information         | ..... | 24                    |
| Product Qualification Specification  | ..... | 25                    |

**PKU 5\$00E series DC/DC Converters**  
 Input 18 - 72 V, Output up to 10 A / 35 W

EN/LZT 146 391 R5A September 2017

© Flex

### Ordering Information

| Product program | Output             |
|-----------------|--------------------|
| PKU 5310E       | 3.3 V, 10 A / 33 W |
| PKU 5311E       | 5 V, 7 A / 35 W    |
| PKU 5313E       | 12V, 3A / 33W      |
| PKU 5315E       | 15V, 2A / 30W      |

### Product number and Packaging

| PKU 5XXXE n1n2n3n4           |    |    |    |    |
|------------------------------|----|----|----|----|
| Options                      | n1 | n2 | n3 | n4 |
| Mounting                     | o  |    |    |    |
| Remote Control logic         |    | o  |    |    |
| Lead length                  |    |    | o  |    |
| Delivery package information |    |    |    | o  |

| Options | Description   |
|---------|---|
| n1      | PI Through hole<br>SI Surface mount                                 |
| n2      | Negative *<br>P Positive  |
| n3      | 5.30 mm *<br>LA 3.69 mm<br>LB 4.57 mm                               |
| n4      | /B Tray<br>/C Tape and Reel (only valid for surface mount products) |

Example a through-hole mounted, negative logic, short pin product with tray packaging would be PKU 4315E PILA/B.

\* Standard variant (i.e. no option selected).

### General Information

#### Reliability

The failure rate ( $\lambda$ ) and mean time between failures (MTBF =  $1/\lambda$ ) is calculated at max output power and an operating ambient temperature ( $T_A$ ) of +40°C. Flex uses Telcordia SR-332 Issue 2 Method 1 to calculate the mean steady-state failure rate and standard deviation ( $\sigma$ ).

Telcordia SR-332 Issue 2 also provides techniques to estimate the upper confidence levels of failure rates based on the mean and standard deviation.

| Mean steady-state failure rate, $\lambda$ | Std. deviation, $\sigma$ |
|---|--------------------------|
| 241 nFailures/h                           | 31.9 nFailures/h         |

MTBF (mean value) for the PKU-E series = 4.2 Mh.  
 MTBF at 90% confidence level = 3.6 Mh

### Compatibility with RoHS requirements

The products are compatible with the relevant clauses and requirements of the RoHS directive 2002/95/EC and have a maximum concentration value of 0.1% by weight in homogeneous materials for lead, mercury, hexavalent chromium, PBB and PBDE and of 0.01% by weight in homogeneous materials for cadmium.

Exemptions in the RoHS directive utilized in Flex products include:

- Lead in high melting temperature type solder (used to solder the die in semiconductor packages)
- Lead in glass of electronics components and in electronic ceramic parts (e.g. fill material in chip resistors)
- Lead as an alloying element in copper alloy containing up to 4% lead by weight (used in connection pins made of Brass)

### Quality Statement

The products are designed and manufactured in an industrial environment where quality systems and methods like ISO 9000, 6 $\sigma$  (sigma), and SPC are intensively in use to boost the continuous improvements strategy. Infant mortality or early failures in the products are screened out and they are subjected to an ATE-based final test. Conservative design rules, design reviews and product qualifications, plus the high competence of an engaged work force, contribute to the high quality of our products.

### Warranty

Warranty period and conditions are defined in Flex General Terms and Conditions of Sale.

### Limitation of Liability

Flex does not make any other warranties, expressed or implied including any warranty of merchantability or fitness for a particular purpose (including, but not limited to, use in life support applications, where malfunctions of product can cause injury to a person's health or life).

|  |                                   |
|--|-----------------------------------|
| <b>PKU 5\$00E series DC/DC Converters</b><br>Input 18 - 72 V, Output up to 10 A / 35 W | EN/LZT 146 391 R5A September 2017 |
|  | © Flex                            |

## Safety Specification

### General information

Flex DC/DC converters and DC/DC regulators are designed in accordance with safety standards IEC/EN/UL 60950-1 *Safety of Information Technology Equipment*.

IEC/EN/UL 60950-1 contains requirements to prevent injury or damage due to the following hazards:

- Electrical shock
- Energy hazards
- Fire
- Mechanical and heat hazards
- Radiation hazards
- Chemical hazards

On-board DC/DC converters and DC/DC regulators are defined as component power supplies. As components they cannot fully comply with the provisions of any safety requirements without "Conditions of Acceptability". Clearance between conductors and between conductive parts of the component power supply and conductors on the board in the final product must meet the applicable safety requirements. Certain conditions of acceptability apply for component power supplies with limited stand-off (see Mechanical Information for further information). It is the responsibility of the installer to ensure that the final product housing these components complies with the requirements of all applicable safety standards and regulations for the final product.

Component power supplies for general use should comply with the requirements in IEC 60950-1, EN 60950-1 and UL 60950-1 *Safety of Information Technology Equipment*. There are other more product related standards, e.g. IEEE 802.3 *CSMA/CD (Ethernet) Access Method*, and ETS-300132-2 *Power supply interface at the input to telecommunications equipment, operated by direct current (dc)*, but all of these standards are based on IEC/EN/UL 60950-1 with regards to safety.

Flex DC/DC converters and DC/DC regulators are UL 60950-1 recognized and certified in accordance with EN 60950-1.

The flammability rating for all construction parts of the products meet requirements for V-0 class material according to IEC 60695-11-10, *Fire hazard testing, test flames* – 50 W horizontal and vertical flame test methods.

The products should be installed in the end-use equipment, in accordance with the requirements of the ultimate application. Normally the output of the DC/DC converter is considered as SELV (Safety Extra Low Voltage) and the input source must be isolated by minimum Double or Reinforced Insulation from the primary circuit (AC mains) in accordance with IEC/EN/UL 60950-1.

### Isolated DC/DC converters

It is recommended that a slow blow fuse is to be used at the input of each DC/DC converter. If an input filter is used in the circuit the fuse should be placed in front of the input filter.

In the rare event of a component problem that imposes a short circuit on the input source, this fuse will provide the following functions:

- Isolate the fault from the input power source so as not to affect the operation of other parts of the system.
- Protect the distribution wiring from excessive current and power loss thus preventing hazardous overheating.

The galvanic isolation is verified in an electric strength test. The test voltage ( $V_{iso}$ ) between input and output is 1500 Vdc or 2250 Vdc (refer to product specification).

### 24 V DC systems

The input voltage to the DC/DC converter is SELV (Safety Extra Low Voltage) and the output remains SELV under normal and abnormal operating conditions.

### 48 and 60 V DC systems

If the input voltage to the DC/DC converter is 75 Vdc or less, then the output remains SELV (Safety Extra Low Voltage) under normal and abnormal operating conditions.

Single fault testing in the input power supply circuit should be performed with the DC/DC converter connected to demonstrate that the input voltage does not exceed 75 Vdc.

If the input power source circuit is a DC power system, the source may be treated as a TNV-2 circuit and testing has demonstrated compliance with SELV limits in accordance with IEC/EN/UL60950-1.

**PKU 5\$00E series DC/DC Converters**  
 Input 18 - 72 V, Output up to 10 A / 35 W

EN/LZT 146 391 R5A September 2017

© Flex

**Absolute Maximum Ratings**

| Characteristics |  | min                   | typ  | max        | Unit |
|-----------------|--|-----------------------|------|------------|------|
| $T_{P1}$        | Operating Temperature (see Thermal Consideration section)      | -40                   |      | +105       | °C   |
| $T_S$           | Storage temperature  | -55                   |      | +100       | °C   |
| $V_I$           | Input voltage  | -0.5                  |      | +80        | V    |
| $V_{iso}$       | Isolation voltage (input to output test voltage)               |                       |      | 1500       | Vdc  |
| $V_{tr}$        | Input voltage transient ( $t_p$ 100 ms)                        |                       |      | 100        | V    |
| $V_{RC}$        | Remote Control pin voltage (see Operating Information section) | Positive logic option |      | 40         | V    |
|                 |  | Negative logic option | -0.5 | 40         | V    |
| $V_{adj}$       | Adjust pin voltage (see Operating Information section)         | -0.5                  |      | $2xV_{oi}$ | V    |

Stress in excess of Absolute Maximum Ratings may cause permanent damage. Absolute Maximum Ratings, sometimes referred to as no destruction limits, are normally tested with one parameter at a time exceeding the limits of Output data or Electrical Characteristics. If exposed to stress above these limits, function and performance may degrade in an unspecified manner.

**Fundamental Circuit Diagram**

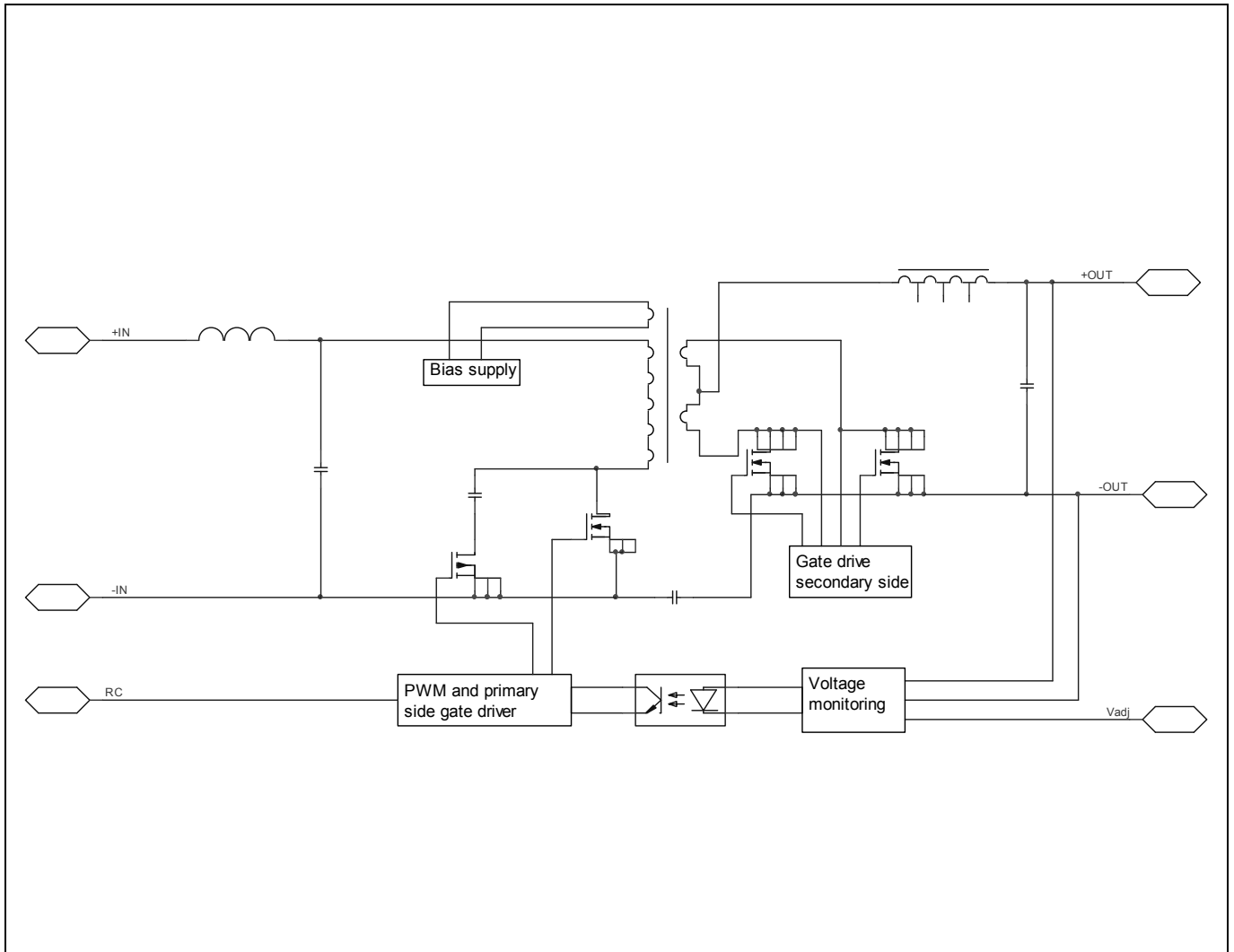

**PKU 5\$00E series DC/DC Converters**  
Input 18 - 72 V, Output up to 10 A / 35 W

EN/LZT 146 391 R5A September 2017

© Flex

**3.3 V/10 A Electrical Specification**

**PKU 5310E PI**

$T_{P1} = -30$  to  $+90^{\circ}\text{C}$ ,  $V_I = 18$  to  $72$  V, unless otherwise specified under Conditions.

Typical values given at:  $T_{P1} = +25^{\circ}\text{C}$ ,  $V_I = 53$  V,  $I_O = \text{max } I_O$ , unless otherwise specified under Conditions.

Additional  $C_O = 220 \mu\text{F}$ .

| Characteristics   |                            | Conditions                        | min | typ  | max | Unit          |
|-------------------|----------------------------|-----------------------------------|-----|------|-----|---------------|
| $V_I$             | Input voltage range        |                                   | 18  |      | 72  | V             |
| $V_{\text{loff}}$ | Turn-off input voltage     | Decreasing input voltage          | 15  | 16   | 17  | V             |
| $V_{\text{lon}}$  | Turn-on input voltage      | Increasing input voltage          | 16  | 17   | 18  | V             |
| $C_I$             | Internal input capacitance |                                   |     | 4.4  |     | $\mu\text{F}$ |
| $P_O$             | Output power               | Output voltage initial setting    | 0   |      | 33  | W             |
| $\eta$            | Efficiency                 | 50 % of max $I_O$ , $V_I = 27$ V  |     | 89.4 |     | %             |
|                   |                            | max $I_O$ , $V_I = 27$ V          |     | 89.2 |     |               |
|                   |                            | 50 % of max $I_O$ , $V_I = 53$ V  |     | 87.3 |     |               |
|                   |                            | max $I_O$ , $V_I = 53$ V          |     | 88.1 |     |               |
| $P_d$             | Power Dissipation          | max $I_O$                         |     | 4.4  | 7.5 | W             |
| $P_{\text{li}}$   | Input idling power         | $I_O = 0$ A, $V_I = 53$ V         |     | 1.8  |     | W             |
| $P_{\text{RC}}$   | Input standby power        | $V_I = 53$ V (turned off with RC) |     | 0.65 |     | W             |
| $f_s$             | Switching frequency        | 0-100 % of max $I_O$              | 255 | 285  | 315 | kHz           |

|                  |  |   |      |           |           |               |
|------------------|--|---|------|-----------|-----------|---------------|
| $V_{O_i}$        | Output voltage initial setting and accuracy                  | $T_{P1} = +25^{\circ}\text{C}$ , $V_I = 53$ V, $I_O = 10$ A                                   | 3.24 | 3.30      | 3.36      | V             |
| $V_O$            | Output adjust range  | See operating information   | 2.97 |           | 3.63      | V             |
|                  | Output voltage tolerance band                                | 10-100 % of max $I_O$   | 3.20 |           | 3.40      | V             |
|                  | Idling voltage   | $I_O = 0$ A   | 3.24 |           | 3.36      | V             |
|                  | Line regulation  | max $I_O$   |      | $\pm 5$   | $\pm 25$  | mV            |
|                  | Load regulation  | $V_I = 53$ V, 0-100 % of max $I_O$  |      | $\pm 5$   | $\pm 25$  | mV            |
| $V_{\text{tr}}$  | Load transient voltage deviation                             | $V_I = 53$ V, Load step 25-75-25 % of max $I_O$ , $di/dt = 5$ A/ $\mu\text{s}$ , $C_O = 1$ mF |      | $\pm 250$ | $\pm 400$ | mV            |
| $t_{\text{tr}}$  | Load transient recovery time                                 |   |      | 250       | 400       | $\mu\text{s}$ |
| $t_r$            | Ramp-up time (from 10-90 % of $V_{O_i}$ )                    | 10-100 % of max $I_O$   |      | 7         |           | ms            |
| $t_s$            | Start-up time (from $V_I$ connection to 90 % of $V_{O_i}$ )  |   |      | 8         |           | ms            |
| $t_f$            | $V_I$ shut-down fall time (from $V_I$ off to 10 % of $V_O$ ) | max $I_O$   |      | 2         |           | ms            |
|                  |  | $I_O = 0$ A   |      | 15        |           | s             |
| $t_{\text{RC}}$  | RC start-up time   | max $I_O$   |      | 8         |           | ms            |
|                  | RC shut-down fall time (from RC off to 10 % of $V_O$ )       | max $I_O$   |      | 0.35      |           | ms            |
|                  |  | $I_O = 0$ A   |      | 15        |           | s             |
| $I_O$            | Output current   |   | 0    |           | 10        | A             |
| $I_{\text{lim}}$ | Current limit threshold                                      | $V_I = 53$ V, $T_{P1} < \text{max } T_{P1}$   |      | 15        | 20        | A             |
| $I_{\text{sc}}$  | Short circuit current  | $T_{P1} = 25^{\circ}\text{C}$ , Note 1  |      | 18        |           | A             |
| $V_{\text{Oac}}$ | Output ripple & noise  | See ripple & noise section, max $I_O$ , $V_{O_i}$ , $C_O = 220\mu\text{F}$                    |      | 45        | 80        | mVp-p         |
| OVP              | Over voltage protection                                      | $T_{P1} = +25^{\circ}\text{C}$ , $V_I = 53$ V, 0-100 % of max $I_O$                           |      | 3.9       |           | V             |

1) RMS value

**PKU 5\$00E series DC/DC Converters**  
 Input 18 - 72 V, Output up to 10 A / 35 W

EN/LZT 146 391 R5A September 2017

© Flex

**3.3 V/10 A Typical Characteristics**

**PKU 5310E PI**

**Efficiency**

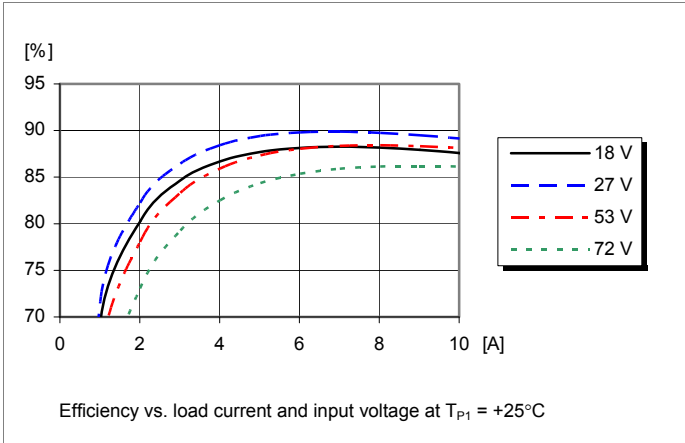

**Power Dissipation**

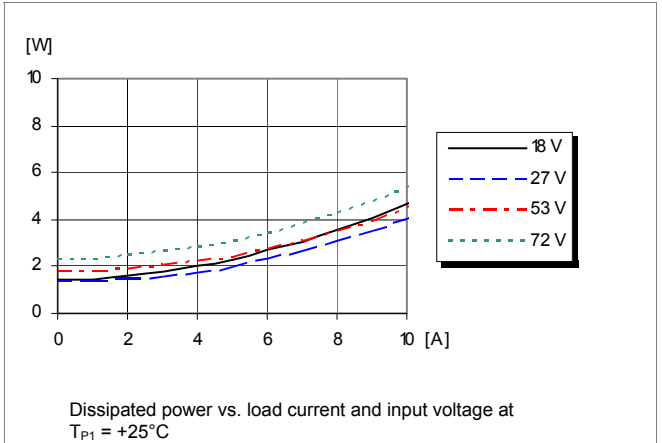

**Output Characteristics**

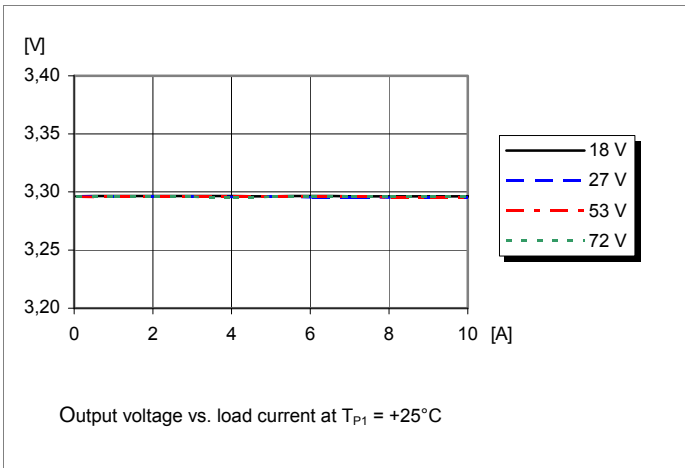

**Current Limit Characteristics**

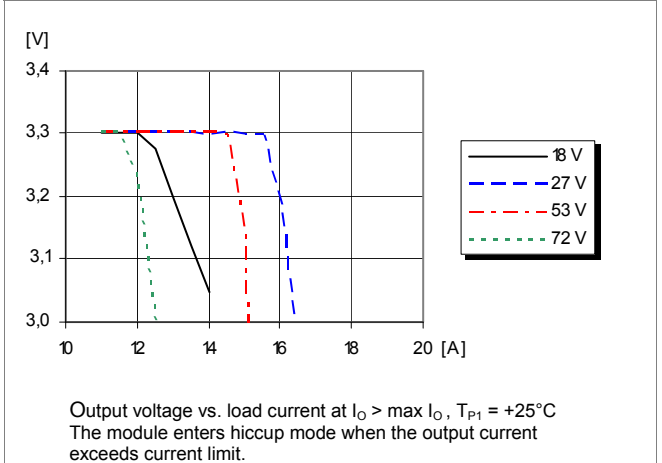

**Output Current Derating**

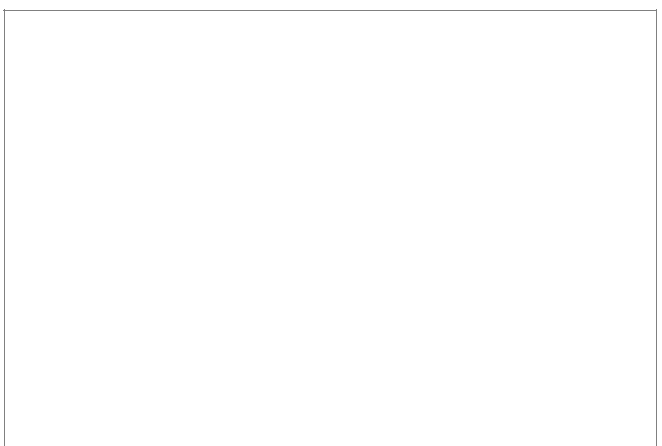
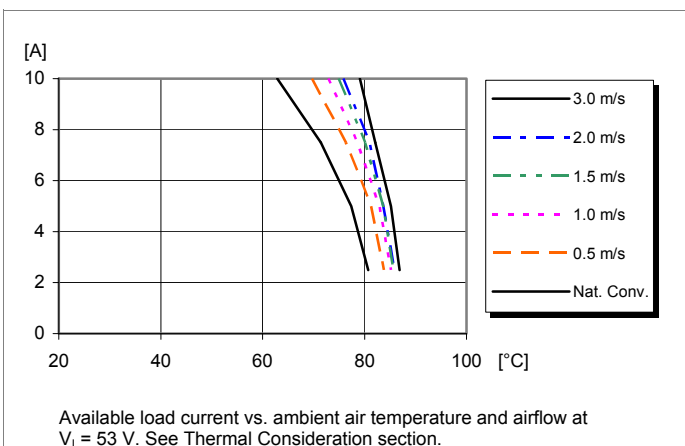

**PKU 5\$00E series DC/DC Converters**  
 Input 18 - 72 V, Output up to 10 A / 35 W

EN/LZT 146 391 R5A September 2017

© Flex

### 3.3 V/10 A Typical Characteristics

**PKU 5310E PI**

#### Start-up

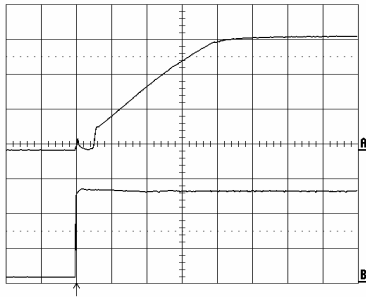

Start-up enabled by connecting  $V_1$  at:  
 $T_{P1} = +25^\circ\text{C}$ ,  $V_1 = 53\text{ V}$ ,  
 $I_O = 10\text{ A}$  resistive load.

Top trace: output voltage (1 V/div.).  
 Bottom trace: input voltage (20 V/div.).  
 Time scale: (2 ms/div.).

#### Shut-down

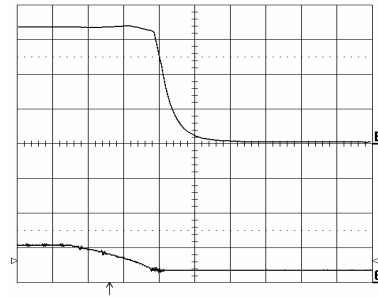

Shut-down enabled by disconnecting  $V_1$  at:  
 $T_{P1} = +25^\circ\text{C}$ ,  $V_1 = 53\text{ V}$ ,  
 $I_O = 10\text{ A}$  resistive load.

Top trace: output voltage (1 V/div.).  
 Bottom trace: input voltage (50 V/div.).  
 Time scale: (0.5 ms/div.).

#### Output Ripple & Noise

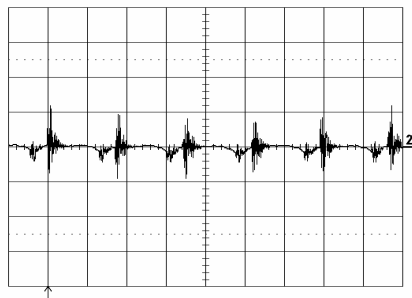

Output voltage ripple at:  
 $T_{P1} = +25^\circ\text{C}$ ,  $V_1 = 53\text{ V}$ ,  
 $I_O = 10\text{ A}$  resistive load.

Trace: output voltage (20 mV/div.).  
 Time scale: (2  $\mu\text{s}$ /div.).  
 Additional  $C_o = 220\mu\text{F}$

#### Output Load Transient Response

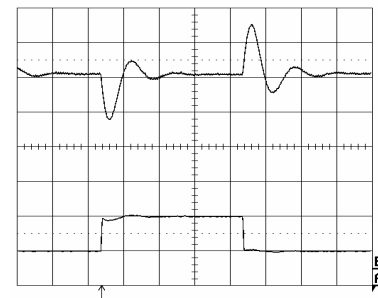

Output voltage response to load current step-  
 change (2.5-7.5-2.5 A) at:  
 $T_{P1} = +25^\circ\text{C}$ ,  $V_1 = 53\text{ V}$ ,  $C_o = 1\text{ mF}$

Top trace: output voltage (200 mV/div.).  
 Bottom trace: load current (5 A/div.).  
 Time scale: (0.5 ms/div.).

#### Output Voltage Adjust (see operating information)

##### Passive adjust

The resistor value for an adjusted output voltage is calculated by using the following equations:

Output Voltage Adjust Upwards, Increase:

$$R_{adj} = \left( \frac{5.11 \times 3.30(100 + \Delta\%) - 511}{1.225 \times \Delta\%} - 10.22 \right) \text{ k}\Omega$$

Example: Increase 4%  $\Rightarrow V_{out} = 3.432\text{ Vdc}$

$$\left( \frac{5.11 \times 3.30(100 + 4)}{1.225 \times 4} - 10.22 \right) \text{ k}\Omega = 220\text{ k}\Omega$$

##### Active adjust

The output voltage may be adjusted using a voltage applied to the Vadj pin. This voltage is calculated by using the following equations:

$$V_{adj} = \left( 1.225 + 2.45 \times \frac{V_{desired} - 3.30}{3.30} \right) \text{ V}$$

Example: Upwards  $\Rightarrow 3.50\text{ V}$

$$\left( 1.225 + 2.45 \times \frac{3.50 - 3.30}{3.30} \right) \text{ V} = 1.37\text{ V}$$

**PKU 5\$00E series DC/DC Converters**  
Input 18 - 72 V, Output up to 10 A / 35 W

EN/LZT 146 391 R5A September 2017

© Flex

**5 V/7 A Electrical Specification**

**PKU 5311E PI**

$T_{P1} = -30$  to  $+90^{\circ}\text{C}$ ,  $V_I = 18$  to  $72$  V, unless otherwise specified under Conditions.

Typical values given at:  $T_{P1} = +25^{\circ}\text{C}$ ,  $V_I = 53$  V,  $I_O = \text{max } I_O$ , unless otherwise specified under Conditions.

Additional  $C_O = 150$   $\mu\text{F}$ .

| Characteristics   |                            | Conditions                        | min | typ  | max | Unit          |
|-------------------|----------------------------|-----------------------------------|-----|------|-----|---------------|
| $V_I$             | Input voltage range        |                                   | 18  |      | 72  | V             |
| $V_{\text{loff}}$ | Turn-off input voltage     | Decreasing input voltage          | 15  | 16   | 17  | V             |
| $V_{\text{lon}}$  | Turn-on input voltage      | Increasing input voltage          | 16  | 17   | 18  | V             |
| $C_I$             | Internal input capacitance |                                   |     | 4.4  |     | $\mu\text{F}$ |
| $P_O$             | Output power               | Output voltage initial setting    | 0   |      | 35  | W             |
| $\eta$            | Efficiency                 | 50 % of max $I_O$ , $V_I = 27$ V  |     | 91.7 |     | %             |
|                   |                            | max $I_O$ , $V_I = 27$ V          |     | 91.0 |     |               |
|                   |                            | 50 % of max $I_O$ , $V_I = 53$ V  |     | 89.4 |     |               |
|                   |                            | max $I_O$ , $V_I = 53$ V          |     | 90.5 |     |               |
| $P_d$             | Power Dissipation          | max $I_O$                         |     | 3.8  | 5.6 | W             |
| $P_{\text{li}}$   | Input idling power         | $I_O = 0$ A, $V_I = 53$ V         |     | 1.6  |     | W             |
| $P_{\text{RC}}$   | Input standby power        | $V_I = 53$ V (turned off with RC) |     | 0.5  |     | W             |
| $f_s$             | Switching frequency        | 0-100 % of max $I_O$              | 255 | 285  | 315 | kHz           |

|                  |   |  |      |           |           |               |
|------------------|---|--|------|-----------|-----------|---------------|
| $V_{\text{Oi}}$  | Output voltage initial setting and accuracy                       | $T_{P1} = +25^{\circ}\text{C}$ , $V_I = 53$ V, $I_O = 7$ A   | 4.9  | 5         | 5.1       | V             |
| $V_O$            | Output adjust range   | See operating information  | 4.5  |           | 5.5       | V             |
|                  | Output voltage tolerance band                                     | 10-100 % of max $I_O$  | 4.85 |           | 5.15      | V             |
|                  | Idling voltage  | $I_O = 0$ A  | 4.9  |           | 5.1       | V             |
|                  | Line regulation   | max $I_O$  |      | $\pm 5$   | $\pm 25$  | mV            |
|                  | Load regulation   | $V_I = 53$ V, 0-100 % of max $I_O$   |      | $\pm 5$   | $\pm 25$  | mV            |
| $V_{\text{tr}}$  | Load transient voltage deviation                                  | $V_I = 53$ V, Load step 25-75-25 % of max $I_O$ , $di/dt = 5$ A/ $\mu\text{s}$ , $C_O = 700$ $\mu\text{F}$ |      | $\pm 300$ | $\pm 500$ | mV            |
| $t_{\text{tr}}$  | Load transient recovery time                                      |  |      | 250       | 400       | $\mu\text{s}$ |
| $t_r$            | Ramp-up time (from 10-90 % of $V_{\text{Oi}}$ )                   | 10-100 % of max $I_O$  |      | 5.0       | 15        | ms            |
| $t_s$            | Start-up time (from $V_I$ connection to 90 % of $V_{\text{Oi}}$ ) |  |      | 6.5       | 20        | ms            |
| $t_f$            | $V_I$ shut-down fall time (from $V_I$ off to 10 % of $V_O$ )      | max $I_O$  | 0.2  | 2         |           | ms            |
|                  |   | $I_O = 0$ A  |      | 1.4       |           | s             |
| $t_{\text{RC}}$  | RC start-up time  | max $I_O$  |      | 7.0       |           | ms            |
|                  | RC shut-down fall time (from RC off to 10 % of $V_O$ )            | max $I_O$  | 0.2  | 0.4       |           | ms            |
|                  |   | $I_O = 0$ A  |      | 2.3       |           | s             |
| $I_O$            | Output current  |  | 0    |           | 7         | A             |
| $I_{\text{lim}}$ | Current limit threshold   | $V_I = 53$ V, $T_{P1} < \text{max } T_{P1}$  |      | 11        | 14.5      | A             |
| $I_{\text{sc}}$  | Short circuit current   | $T_{P1} = 25^{\circ}\text{C}$ , Note 1   |      | 12        |           | A             |
| $V_{\text{Oac}}$ | Output ripple & noise   | See ripple & noise section, max $I_O$ , $V_{\text{Oi}}$ , $C_O = 220$ $\mu\text{F}$                        |      | 25        | 60        | mVp-p         |
| OVP              | Over voltage protection   | $T_{P1} = +25^{\circ}\text{C}$ , $V_I = 53$ V, 0-100 % of max $I_O$  |      | 7         |           | V             |

1) RMS value



**PKU 5\$00E series DC/DC Converters**  
 Input 18 - 72 V, Output up to 10 A / 35 W

EN/LZT 146 391 R5A September 2017

© Flex

### 5 V/7 A Typical Characteristics

**PKU 5311E PI**

#### Efficiency

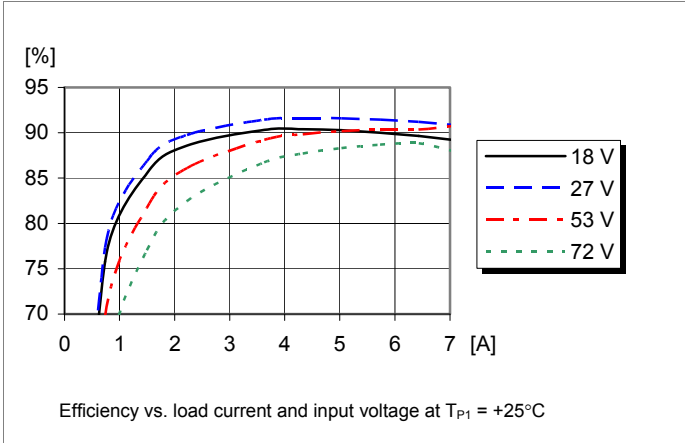

#### Power Dissipation

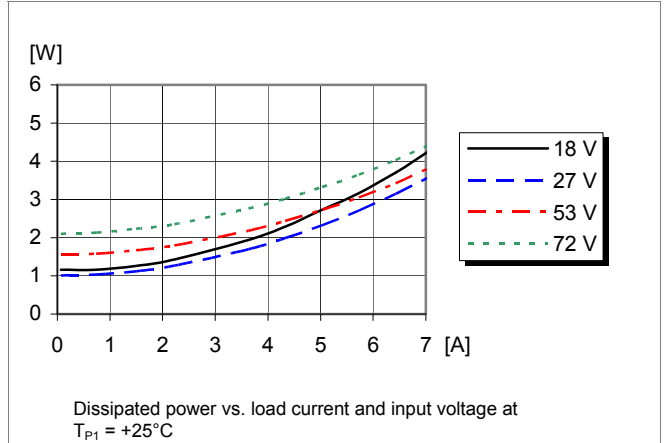

#### Output Characteristics

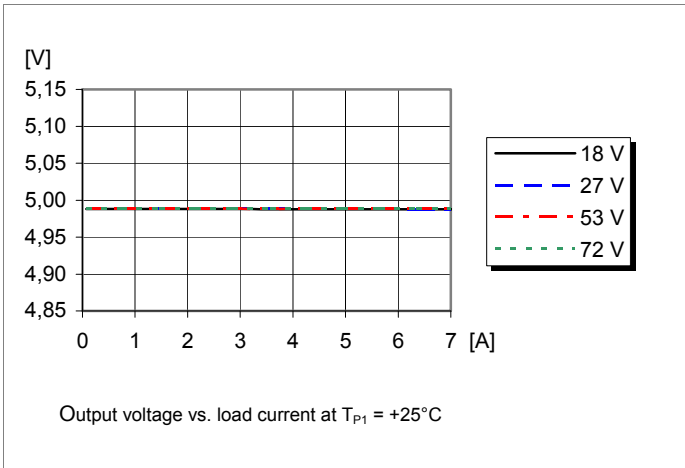

#### Current Limit Characteristics

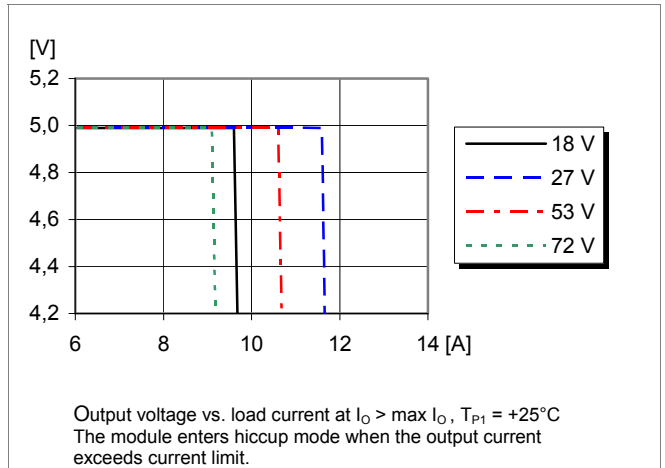

#### Output Current Derating

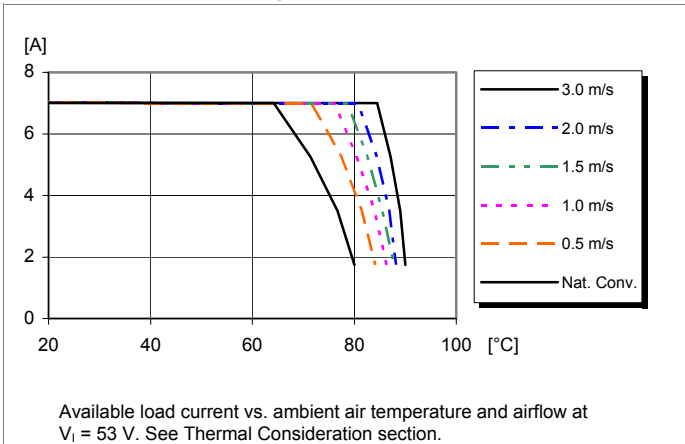

**PKU 5\$00E series DC/DC Converters**  
 Input 18 - 72 V, Output up to 10 A / 35 W

EN/LZT 146 391 R5A September 2017

© Flex

## 5 V/7 A Typical Characteristics

**PKU 5311E PI**

### Start-up

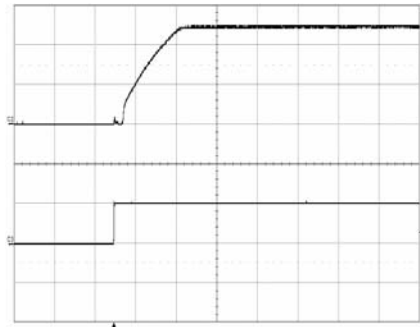

Start-up enabled by connecting  $V_i$  at:  
 $T_{P1} = +25^\circ\text{C}$ ,  $V_i = 53\text{ V}$ ,  
 $I_o = 7\text{ A}$  load.

Top trace: output voltage (2 V/div.).  
 Bottom trace: input voltage (50 V/div.).  
 Time scale: (5 ms/div.).

### Shut-down

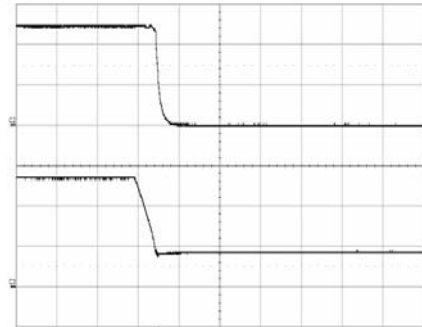

Shut-down enabled by disconnecting  $V_i$  at:  
 $T_{P1} = +25^\circ\text{C}$ ,  $V_i = 53\text{ V}$ ,  
 $I_o = 7\text{ A}$  resistive load.

Top trace: output voltage (2 V/div.).  
 Bottom trace: input voltage (20 V/div.).  
 Time scale: (2 ms/div.).

### Output Ripple & Noise

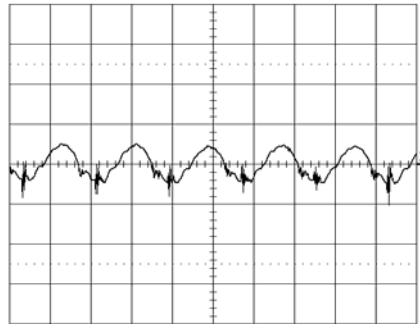

Output voltage ripple at:  
 $T_{P1} = +25^\circ\text{C}$ ,  $V_i = 53\text{ V}$ ,  
 $I_o = 7\text{ A}$  resistive load.

Trace: output voltage (20 mV/div.).  
 Time scale: (2 μs/div.).  
 Additional  $C_o = 220\mu\text{F}$

### Output Load Transient Response

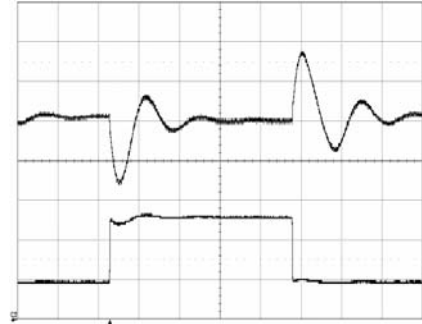

Output voltage response to load current step-  
 change (1.75 - 5.25 - 1.75 A) at:  
 $T_{P1} = +25^\circ\text{C}$ ,  $V_i = 53\text{ V}$ ,  $C_o = 690\mu\text{F}$

Top trace: output voltage (200 mV/div.).  
 Bottom trace: load current (2 A/div.).  
 Time scale: (0.5 ms/div.).

### Output Voltage Adjust (see operating information)

#### Passive adjust

The resistor value for an adjusted output voltage is calculated by using the following equations:

Output Voltage Adjust Upwards, Increase:

$$R_{adj} = \left( \frac{5.11 \times 5.0(100 + \Delta\%)}{1.225 \times \Delta\%} - \frac{511}{\Delta\%} - 10.22 \right) \text{ k}\Omega$$

Example: Increase 4% =>  $V_o = 5.2\text{ Vdc}$

$$\left( \frac{5.11 \times 5.0(100 + 4)}{1.225 \times 4} - \frac{511}{4} - 10.22 \right) \text{ k}\Omega = 404 \text{ k}\Omega$$

#### Active adjust

The output voltage may be adjusted using a voltage applied to the  $V_{adj}$  pin. This voltage is calculated by using the following equations:

$$V_{adj} = \left( 1.225 + 2.45 \times \frac{V_{desired} - 5.0}{5.0} \right) \text{ V}$$

Example: Upwards => 5.2 V

$$\left( 1.225 + 2.45 \times \frac{5.2 - 5.0}{5.0} \right) \text{ V} = 1.323 \text{ V}$$

### PKU 5\$00E series DC/DC Converters Input 18 - 72 V, Output up to 10 A / 35 W

EN/LZT 146 391 R5A September 2017

© Flex

### 12 V/2.75 A Electrical Specification

PKU 5313E PI

$T_{P1} = -30$  to  $+90^{\circ}\text{C}$ ,  $V_I = 18$  to  $72$  V, unless otherwise specified under Conditions.

Typical values given at:  $T_{P1} = +25^{\circ}\text{C}$ ,  $V_I = 53$  V,  $I_O = \text{max } I_O$ , unless otherwise specified under Conditions.

Additional  $C_O = 47 \mu\text{F}$ .

| Characteristics   |                            | Conditions                        | min | typ  | max | Unit          |
|-------------------|----------------------------|-----------------------------------|-----|------|-----|---------------|
| $V_I$             | Input voltage range        |                                   | 18  |      | 72  | V             |
| $V_{\text{loff}}$ | Turn-off input voltage     | Decreasing input voltage          | 15  | 16   | 17  | V             |
| $V_{\text{lon}}$  | Turn-on input voltage      | Increasing input voltage          | 16  | 17   | 18  | V             |
| $C_I$             | Internal input capacitance |                                   |     | 4.4  |     | $\mu\text{F}$ |
| $P_O$             | Output power               | Output voltage initial setting    | 0   |      | 33  | W             |
| $\eta$            | Efficiency                 | 50 % of max $I_O$ , $V_I = 27$ V  |     | 88.8 |     | %             |
|                   |                            | max $I_O$ , $V_I = 27$ V          |     | 89.2 |     |               |
|                   |                            | 50 % of max $I_O$ , $V_I = 53$ V  |     | 85.6 |     |               |
|                   |                            | max $I_O$ , $V_I = 53$ V          |     | 88.0 |     |               |
| $P_d$             | Power Dissipation          | max $I_O$                         |     | 4.8  | 8.2 | W             |
| $P_{\text{li}}$   | Input idling power         | $I_O = 0$ A, $V_I = 53$ V         |     | 2.2  |     | W             |
| $P_{\text{RC}}$   | Input standby power        | $V_I = 53$ V (turned off with RC) |     | 0.4  |     | W             |
| $f_s$             | Switching frequency        | 0-100 % of max $I_O$              | 255 | 285  | 315 | kHz           |

|                  |   |  |       |           |           |               |
|------------------|---|--|-------|-----------|-----------|---------------|
| $V_{\text{Oi}}$  | Output voltage initial setting and accuracy                       | $T_{P1} = +25^{\circ}\text{C}$ , $V_I = 53$ V, $I_O = 2.75$ A  | 11.76 | 12.0      | 12.24     | V             |
| $V_O$            | Output adjust range   | See operating information  | 10.8  |           | 13.2      | V             |
|                  | Output voltage tolerance band                                     | 10-100 % of max $I_O$  | 11.64 |           | 12.36     | V             |
|                  | Idling voltage  | $I_O = 0$ A  | 11.76 |           | 12.24     | V             |
|                  | Line regulation   | max $I_O$  |       | $\pm 5$   | $\pm 50$  | mV            |
|                  | Load regulation   | $V_I = 53$ V, 0-100 % of max $I_O$   |       | $\pm 5$   | $\pm 50$  | mV            |
| $V_{\text{tr}}$  | Load transient voltage deviation                                  | $V_I = 53$ V, Load step 25-75-25 % of max $I_O$ , $di/dt = 5$ A/ $\mu\text{s}$ , $C_O = 275 \mu\text{F}$ |       | $\pm 400$ | $\pm 600$ | mV            |
| $t_{\text{tr}}$  | Load transient recovery time                                      |  |       | 75        | 150       | $\mu\text{s}$ |
| $t_r$            | Ramp-up time (from 10-90 % of $V_{\text{Oi}}$ )                   | 10-100 % of max $I_O$  |       | 5         |           | ms            |
| $t_s$            | Start-up time (from $V_I$ connection to 90 % of $V_{\text{Oi}}$ ) |  |       | 7         |           | ms            |
| $t_f$            | $V_I$ shut-down fall time (from $V_I$ off to 10 % of $V_O$ )      | max $I_O$  | 0.4   | 0.6       |           | ms            |
|                  |   | $I_O = 0$ A  |       | 1         |           | s             |
| $t_{\text{RC}}$  | RC start-up time  | max $I_O$  |       | 30        |           | ms            |
|                  | RC shut-down fall time (from RC off to 10 % of $V_O$ )            | max $I_O$  | 0.4   | 0.6       |           | ms            |
|                  |   | $I_O = 0$ A  |       | 0.7       |           | s             |
| $I_O$            | Output current  |  | 0     |           | 2.75      | A             |
| $I_{\text{lim}}$ | Current limit threshold   | $V_I = 53$ V, $T_{P1} < \text{max } T_{P1}$  |       | 4.3       | 5.6       | A             |
| $I_{\text{sc}}$  | Short circuit current   | $T_{P1} = 25^{\circ}\text{C}$ , Note 1   |       | 8.6       |           | A             |
| $V_{\text{Oac}}$ | Output ripple & noise   | See ripple & noise section, max $I_O$ , $V_{\text{Oi}}$ , $C_O = 47 \mu\text{F}$                         |       | 25        | 50        | mVp-p         |
| OVP              | Over voltage protection   | $T_{P1} = +25^{\circ}\text{C}$ , $V_I = 53$ V, 0-100 % of max $I_O$                                      |       | 16        |           | V             |

1) RMS value

**PKU 5\$00E series DC/DC Converters**  
 Input 18 - 72 V, Output up to 10 A / 35 W

EN/LZT 146 391 R5A September 2017

© Flex

**12 V/2.75 A Typical Characteristics**

**PKU 5313E PI**

**Efficiency**

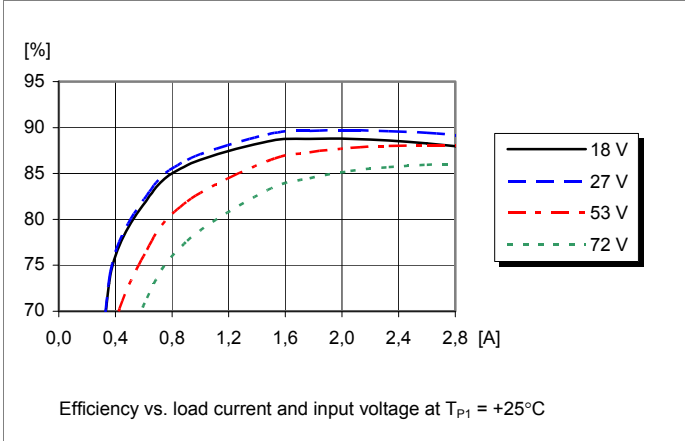

**Power Dissipation**

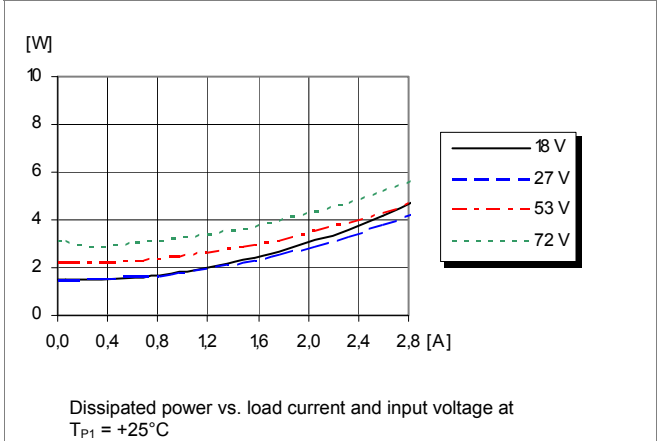

**Output Characteristics**

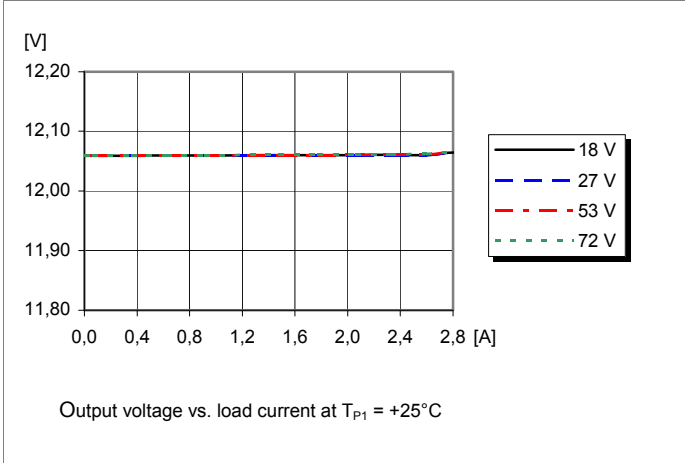

**Current Limit Characteristics**

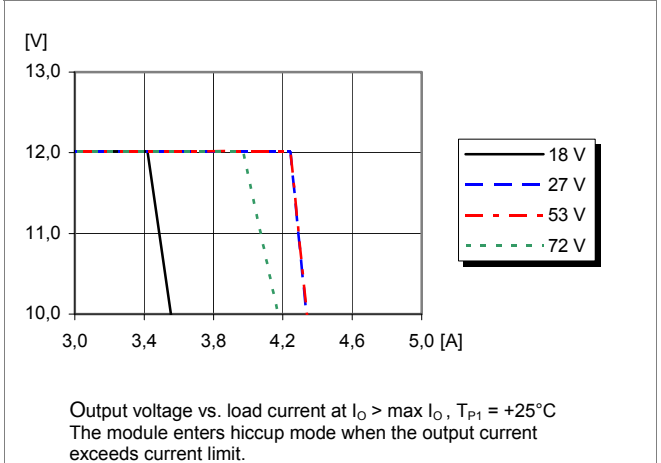

**Output Current Derating**

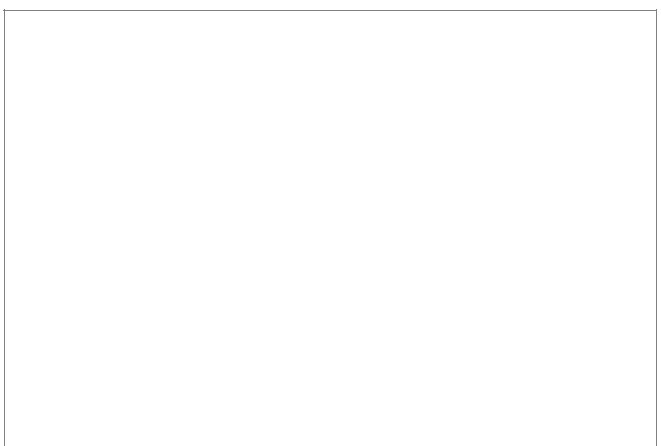
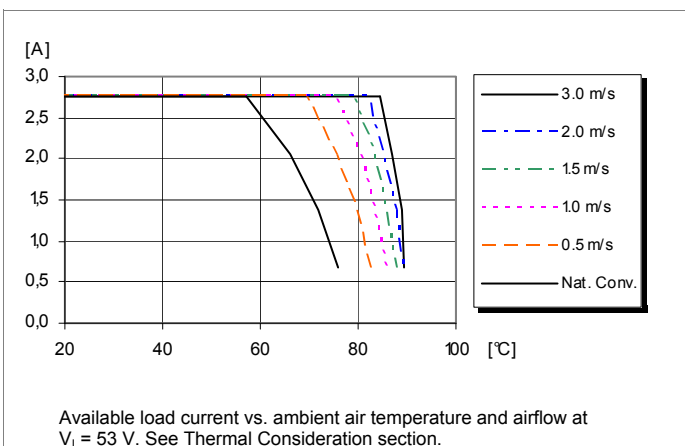

**PKU 5\$00E series DC/DC Converters**  
 Input 18 - 72 V, Output up to 10 A / 35 W

EN/LZT 146 391 R5A September 2017

© Flex

### 12 V/2.75 A Typical Characteristics

**PKU 5313E PI**

#### Start-up

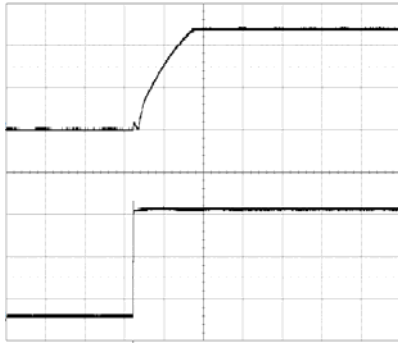

Start-up enabled by connecting  $V_i$  at:  
 $T_{P1} = +25^\circ\text{C}$ ,  $V_i = 53\text{ V}$ ,  
 $I_o = 2.75\text{ A}$  resistive load.

Top trace: output voltage (5 V/div.).  
 Bottom trace: input voltage (20 V/div.).  
 Time scale: (5 ms/div.).

#### Shut-down

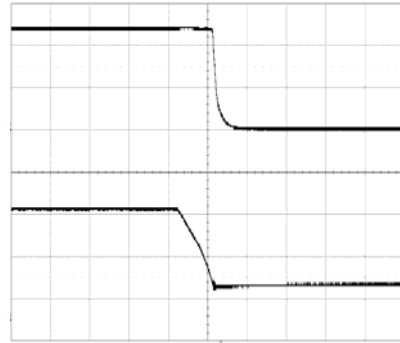

Shut-down enabled by disconnecting  $V_i$  at:  
 $T_{P1} = +25^\circ\text{C}$ ,  $V_i = 53\text{ V}$ ,  
 $I_o = 2.75\text{ A}$  resistive load.

Top trace: output voltage (5 V/div.).  
 Bottom trace: input voltage (20 V/div.).  
 Time scale: (2 ms/div.).

#### Output Ripple & Noise

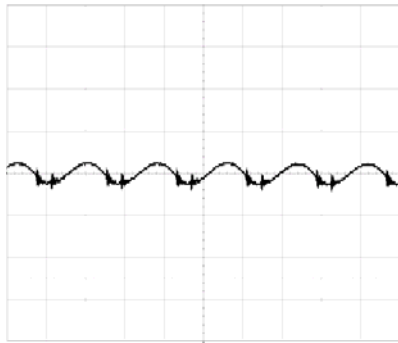

Output voltage ripple at:  
 $T_{P1} = +25^\circ\text{C}$ ,  $V_i = 53\text{ V}$ ,  
 $I_o = 2.75\text{ A}$  resistive load.

Trace: output voltage (20 mV/div.).  
 Time scale: (2 μs/div.).  
 Additional  $C_o = 47\mu\text{F}$

#### Output Load Transient Response

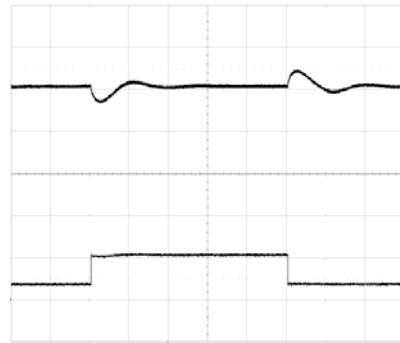

Output voltage response to load current step-change (0.7-2.1-0.7 A) at:  
 $T_{P1} = +25^\circ\text{C}$ ,  $V_i = 53\text{ V}$ ,  $C_o = 275\mu\text{F}$

Top trace: output voltage (1 V/div.).  
 Bottom trace: load current (2 A/div.).  
 Time scale: (0.5 ms/div.).

#### Output Voltage Adjust (see operating information)

##### Passive adjust

The resistor value for an adjusted output voltage is calculated by using the following equations:

Output Voltage Adjust Upwards, Increase:

$$R_{adj} = \left( \frac{5.11 \times 12.0 (100 + \Delta\%)}{1.225 \times \Delta\%} - \frac{511}{\Delta\%} - 10.22 \right) \text{ k}\Omega$$

Example: Increase 4% =>  $V_{out} = 12.48\text{ Vdc}$

$$\left( \frac{5.11 \times 12.0 (100 + 4)}{1.225 \times 4} - \frac{511}{4} - 10.22 \right) \text{ k}\Omega = 1174 \text{ k}\Omega$$

##### Active adjust

The output voltage may be adjusted using a voltage applied to the  $V_{adj}$  pin. This voltage is calculated by using the following equations:

$$V_{adj} = \left( 1.225 + 2.45 \times \frac{V_{desired} - 12.0}{12.0} \right) \text{ V}$$

Example: Upwards => 12.48 V

$$\left( 1.225 + 2.45 \times \frac{12.48 - 12.0}{12.0} \right) \text{ V} = 1.323 \text{ V}$$

**PKU 5\$00E series DC/DC Converters**  
Input 18 - 72 V, Output up to 10 A / 35 W

EN/LZT 146 391 R5A September 2017

© Flex

**15 V/2 A Electrical Specification**

**PKU 5315E PI**

$T_{P1} = -30$  to  $+90^{\circ}\text{C}$ ,  $V_I = 18$  to  $72$  V, unless otherwise specified under Conditions.  
Typical values given at:  $T_{P1} = +25^{\circ}\text{C}$ ,  $V_I = 53$  V,  $I_O = \text{max } I_O$ , unless otherwise specified under Conditions.  
Additional  $C_O = 47 \mu\text{F}$ .

| Characteristics   |                            | Conditions                        | min | typ  | max | Unit          |
|-------------------|----------------------------|-----------------------------------|-----|------|-----|---------------|
| $V_I$             | Input voltage range        |                                   | 18  |      | 72  | V             |
| $V_{\text{loff}}$ | Turn-off input voltage     | Decreasing input voltage          | 15  | 16   | 17  | V             |
| $V_{\text{lon}}$  | Turn-on input voltage      | Increasing input voltage          | 16  | 17   | 18  | V             |
| $C_I$             | Internal input capacitance |                                   |     | 4.4  |     | $\mu\text{F}$ |
| $P_O$             | Output power               | Output voltage initial setting    | 0   |      | 30  | W             |
| $\eta$            | Efficiency                 | 50 % of max $I_O$ , $V_I = 27$ V  |     | 85.6 |     | %             |
|                   |                            | max $I_O$ , $V_I = 27$ V          |     | 89.0 |     |               |
|                   |                            | 50 % of max $I_O$ , $V_I = 53$ V  |     | 80.9 |     |               |
|                   |                            | max $I_O$ , $V_I = 53$ V          |     | 86.7 |     |               |
| $P_d$             | Power Dissipation          | max $I_O$                         |     | 4.6  | 8   | W             |
| $P_{\text{li}}$   | Input idling power         | $I_O = 0$ A, $V_I = 53$ V         |     | 3.2  |     | W             |
| $P_{\text{RC}}$   | Input standby power        | $V_I = 53$ V (turned off with RC) |     | 0.4  |     | W             |
| $f_s$             | Switching frequency        | 0-100 % of max $I_O$              | 280 | 315  | 350 | kHz           |

|                  |  |  |       |           |           |               |
|------------------|--|--|-------|-----------|-----------|---------------|
| $V_{O_i}$        | Output voltage initial setting and accuracy                  | $T_{P1} = +25^{\circ}\text{C}$ , $V_I = 53$ V, $I_O = 2$ A   | 14.70 | 15.0      | 15.30     | V             |
| $V_O$            | Output adjust range  | See operating information, Note 1  | 13.5  |           | 16.5      | V             |
|                  | Output voltage tolerance band                                | 10-100 % of max $I_O$  | 14.70 |           | 15.30     | V             |
|                  | Idling voltage   | $I_O = 0$ A  | 14.70 |           | 15.30     | V             |
|                  | Line regulation  | max $I_O$  |       | $\pm 50$  | $\pm 100$ | mV            |
|                  | Load regulation  | $V_I = 53$ V, 0-100 % of max $I_O$   |       | $\pm 50$  | $\pm 100$ | mV            |
| $V_{\text{tr}}$  | Load transient voltage deviation                             | $V_I = 53$ V, Load step 25-75-25 % of max $I_O$ , $di/dt = 5$ A/ $\mu\text{s}$ , $C_O = 200 \mu\text{F}$ |       | $\pm 300$ | $\pm 500$ | mV            |
| $t_{\text{tr}}$  | Load transient recovery time                                 |  |       | 150       | 250       | $\mu\text{s}$ |
| $t_r$            | Ramp-up time (from 10-90 % of $V_{O_i}$ )                    | 10-100 % of max $I_O$  |       | 5         |           | ms            |
| $t_s$            | Start-up time (from $V_I$ connection to 90 % of $V_{O_i}$ )  |  |       | 6         |           | ms            |
| $t_f$            | $V_I$ shut-down fall time (from $V_I$ off to 10 % of $V_O$ ) | max $I_O$  | 1     | 3         |           | ms            |
|                  |  | $I_O = 0$ A  |       | 1         |           | s             |
| $t_{\text{RC}}$  | RC start-up time   | max $I_O$  |       | 28        |           | ms            |
|                  | RC shut-down fall time (from RC off to 10 % of $V_O$ )       | max $I_O$  | 1     | 2         |           | ms            |
|                  |  | $I_O = 0$ A  |       | 0.5       |           | s             |
| $I_O$            | Output current   |  | 0     |           | 2         | A             |
| $I_{\text{lim}}$ | Current limit threshold                                      | $V_I = 53$ V, $T_{P1} < \text{max } T_{P1}$  |       | 3.2       | 5         | A             |
| $I_{\text{sc}}$  | Short circuit current  | $T_{P1} = 25^{\circ}\text{C}$ , Note 2   |       | 6         |           | A             |
| $V_{\text{Oac}}$ | Output ripple & noise  | See ripple & noise section, max $I_O$ , $V_{O_i}$ , $C_O = 47 \mu\text{F}$                               |       | 25        | 50        | mVp-p         |
| OVP              | Over voltage protection                                      | $T_{P1} = +25^{\circ}\text{C}$ , $V_I = 53$ V, 0-100 % of max $I_O$                                      |       | 19        |           | V             |

1)  $V_I$  min 24 V to obtain 16.5 V at 30 W output power.

2) RMS value

**PKU 5\$00E series DC/DC Converters**  
 Input 18 - 72 V, Output up to 10 A / 35 W

EN/LZT 146 391 R5A September 2017

© Flex

## 15 V/2 A Typical Characteristics

**PKU 5315E PI**

### Efficiency

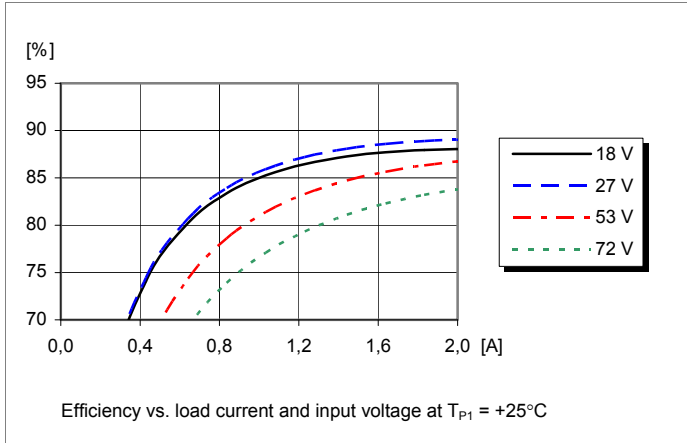

### Power Dissipation

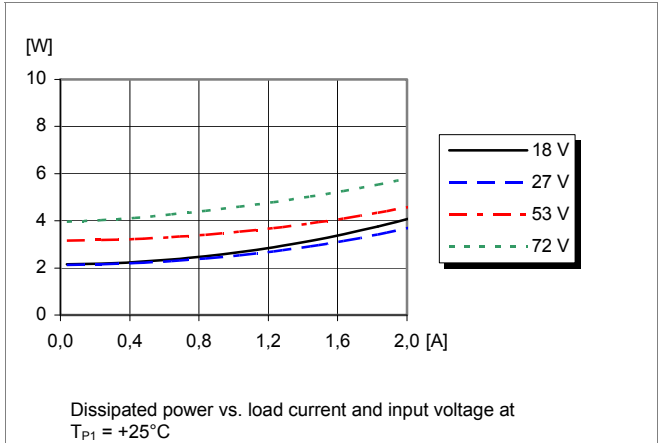

### Output Characteristics

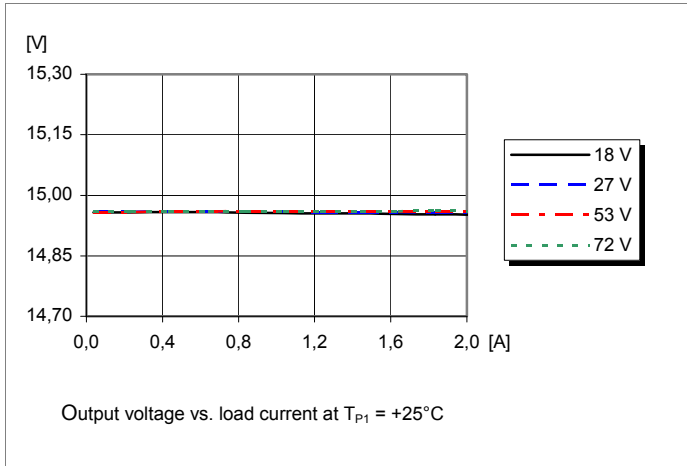

### Current Limit Characteristics

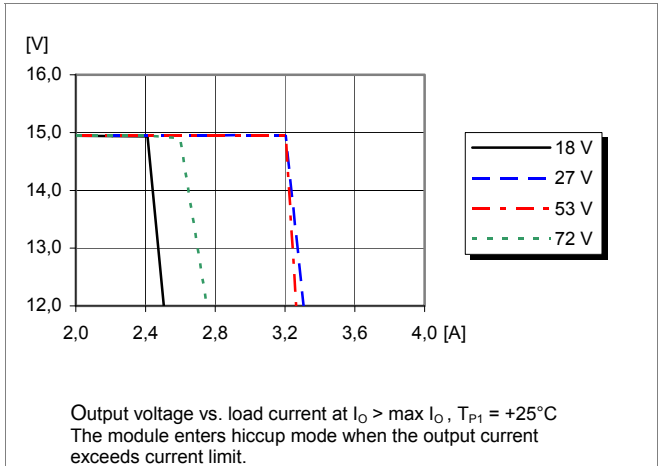

### Output Current Derating

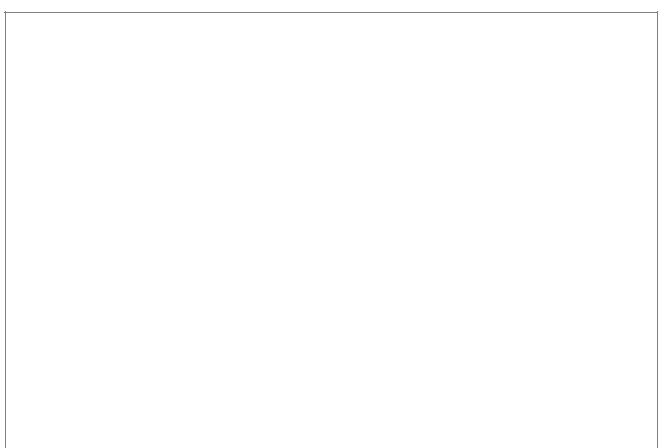
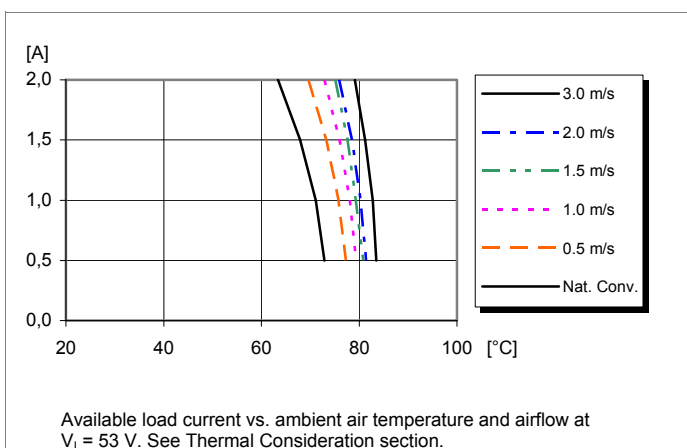

**PKU 5\$00E series DC/DC Converters**  
 Input 18 - 72 V, Output up to 10 A / 35 W

EN/LZT 146 391 R5A September 2017

© Flex

## 15 V/2 A Typical Characteristics

**PKU 5315E PI**

### Start-up

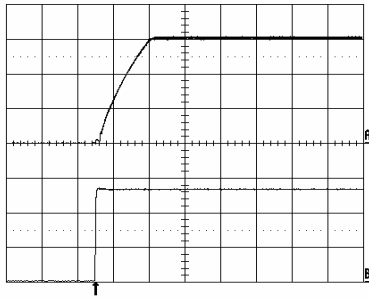

Start-up enabled by connecting  $V_1$  at:  
 $T_{P1} = +25^\circ\text{C}$ ,  $V_1 = 53\text{ V}$ ,  
 $I_O = 2\text{ A}$  resistive load.

Top trace: output voltage (5 V/div.).  
 Bottom trace: input voltage (20 V/div.).  
 Time scale: (5 ms/div.).

### Shut-down

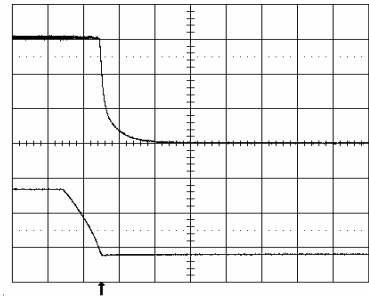

Shut-down enabled by disconnecting  $V_1$  at:  
 $T_{P1} = +25^\circ\text{C}$ ,  $V_1 = 53\text{ V}$ ,  
 $I_O = 2\text{ A}$  resistive load.

Top trace: output voltage (5 V/div.).  
 Bottom trace: input voltage (20 V/div.).  
 Time scale: (2 ms/div.).

### Output Ripple & Noise

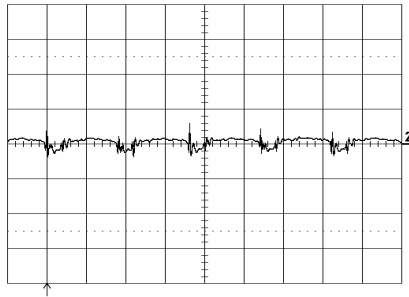

Output voltage ripple at:  
 $T_{P1} = +25^\circ\text{C}$ ,  $V_1 = 53\text{ V}$ ,  
 $I_O = 2\text{ A}$  resistive load.

Trace: output voltage (20 mV/div.).  
 Time scale: (2 μs/div.).  
 Additional  $C_o = 47\mu\text{F}$

### Output Load Transient Response

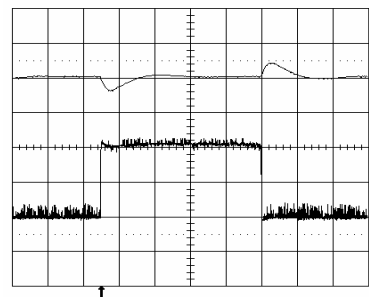

Output voltage response to load current step-  
 change (0.5-1.5-0.5 A) at:  
 $T_{P1} = +25^\circ\text{C}$ ,  $V_1 = 53\text{ V}$ ,  $C_o = 200\mu\text{F}$

Top trace: output voltage (1 V/div.).  
 Bottom trace: load current (0.5 A/div.).  
 Time scale: (0.1 ms/div.).

### Output Voltage Adjust (see operating information)

#### Passive adjust

The resistor value for an adjusted output voltage is calculated by using the following equations:

Output Voltage Adjust Upwards, Increase:

$$R_{adj} = \left( \frac{5.11 \times 15.0 (100 + \Delta\%)}{1.225 \times \Delta\%} - \frac{511}{\Delta\%} - 10.22 \right) \text{ k}\Omega$$

Example: Increase 4% =>  $V_{out} = 15.6\text{ Vdc}$

$$\left( \frac{5.11 \times 15.0 (100 + 4)}{1.225 \times 4} - \frac{511}{4} - 10.22 \right) \text{ k}\Omega = 1489 \text{ k}\Omega$$

#### Active adjust

The output voltage may be adjusted using a voltage applied to the  $V_{adj}$  pin. This voltage is calculated by using the following equations:

$$V_{adj} = \left( 1.225 + 2.45 \times \frac{V_{desired} - 15.0}{15.0} \right) \text{ V}$$

Example: Upwards => 15.6 V

$$\left( 1.225 + 2.45 \times \frac{15.6 - 15.0}{15.0} \right) \text{ V} = 1.323 \text{ V}$$



**PKU 5\$00E series DC/DC Converters**  
 Input 18 - 72 V, Output up to 10 A / 35 W

EN/LZT 146 391 R5A September 2017

© Flex

### EMC Specification

Conducted EMI measured according to EN55022, CISPR 22 and FCC part 15J (see test set-up). See Design Note 009 for further information. The fundamental switching frequency is 285 kHz for PKU 5310E PI, PKU 5311E PI, and PKU 5313E PI. For PKU 5315E PI it is 315 kHz.

### Conducted EMI Input terminal value (typ)

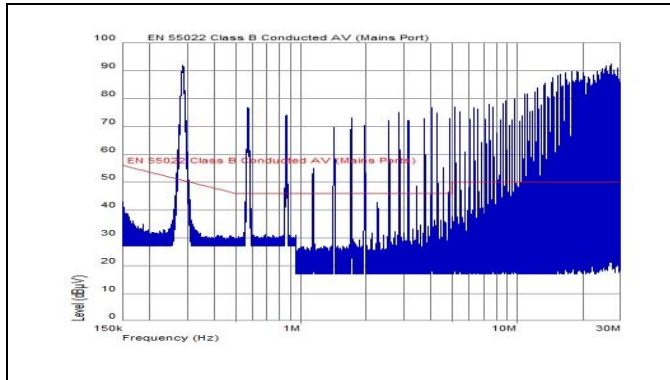

EMI without filter @  $V_I = 53 V$ , max  $I_O$ .

### External filter (class B)

Required external input filter in order to meet class B in EN 55022, CISPR 22 and FCC part 15J.

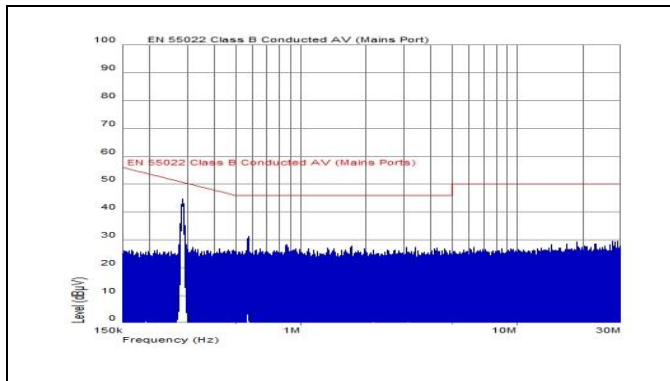
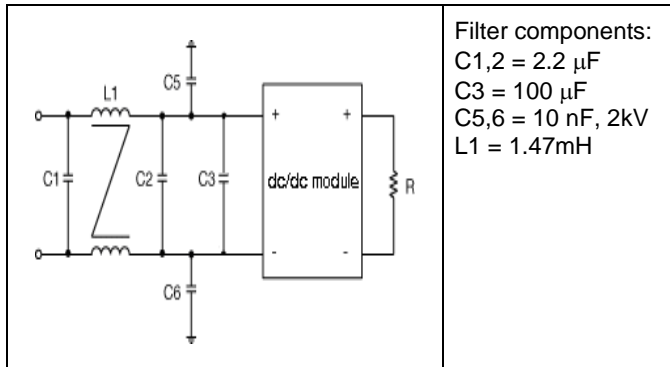

EMI with filter @  $V_I = 53 V$ , max  $I_O$ .

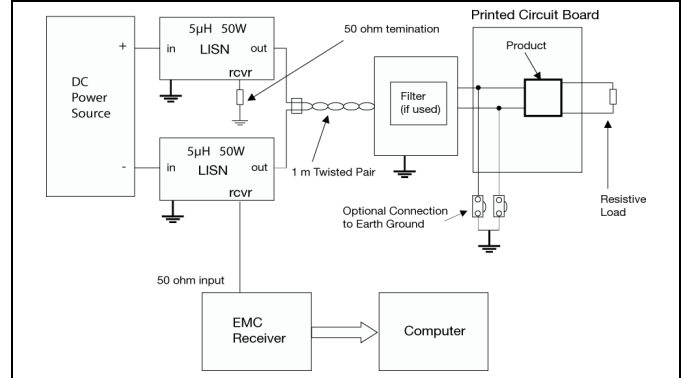

Test set-up

### Layout recommendations

The radiated EMI performance of the Product will depend on the PCB layout and ground layer design. It is also important to consider the stand-off of the product. If a ground layer is used, it should be connected to the output of the product and the equipment ground or chassis.

A ground layer will increase the stray capacitance in the PCB and improve the high frequency EMC performance.

### Output ripple and noise

Output ripple and noise measured according to figure below. See Design Note 022 for detailed information.

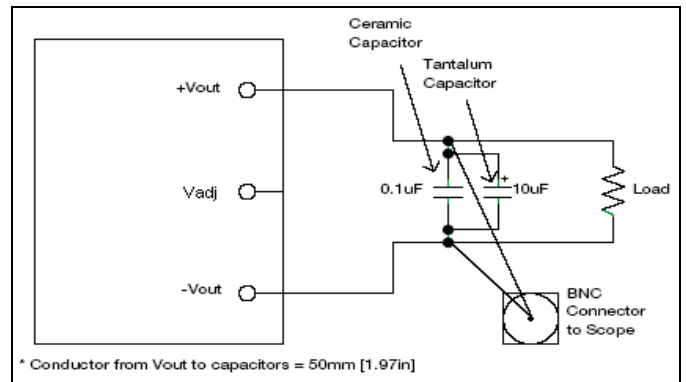

Output ripple and noise test setup

**PKU 5\$00E series DC/DC Converters**  
Input 18 - 72 V, Output up to 10 A / 35 W

EN/LZT 146 391 R5A September 2017

© Flex

## Operating information

### Input Voltage

The input voltage range 18 to 72Vdc meets the requirements of the European Telecom Standard ETS 300 132-2 for normal input voltage range in -48 and -60 Vdc systems, -40.5 to -57.0 V and -50.0 to -72 V respectively.

At input voltages exceeding 72 V, the power loss will be higher than at normal input voltage. Precaution must be taken to keep  $T_{P1}$  below +95°C. The absolute maximum continuous input voltage is 80 Vdc.

### Turn-off Input Voltage

The products monitor the input voltage and will turn on and turn off at predetermined levels.

The minimum hysteresis between turn on and turn off input voltage is 1V. The input voltage supply must have low impedance to prevent the risk of input oscillation, poor supply can also cause shutdown-bouncing.

### Remote Control (RC)

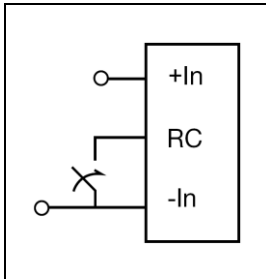

The products are fitted with a remote control function referenced to the primary negative input connection (-In), with negative and positive logic options available. The RC function allows the product to be turned on/off by an external device like a semiconductor or mechanical switch. The RC pin has an internal pull up resistor to +In.

The maximum required sink current is 1 mA. When the RC pin is left open, the voltage generated on the RC pin is 4.5 – 5.5 V.

The standard product is provided with “negative logic” remote control and will be off until the RC pin is connected to the -In. To turn on the product the voltage between RC pin and -In should be less than 1V.

To turn off the converter the RC pin should be left open, or connected to a voltage higher than 4 V referenced to -In. In situations where it is desired to have the product to power up automatically without the need for control signals or a switch, the RC pin can be wired directly to -In.

The second option is “positive logic” remote control, which can be ordered by adding the suffix “P” to the end of the part number.

When the RC pin is left open, the product starts up automatically when the input voltage is applied.

Turn off is achieved by connecting the RC pin to the -In. To ensure safe turn off the voltage difference between RC pin and the -In pin shall be less than 1V. The product will restart automatically when this connection is opened.

See Design Note 021 for detailed information.

## Input and Output Impedance

The impedance of both the input source and the load will interact with the impedance of the DC/DC converter. It is important that the input source has low characteristic impedance.

The performance in some applications can be enhanced by addition of external capacitance as described in External Decoupling Capacitors.

If the input voltage source contains significant inductance, the addition of a low ESR 47  $\mu$ F capacitor across the input of the converter will ensure stable operation in all conditions.

## External Decoupling Capacitors

The products have been designed to operate with a minimum capacitance connected to their output.

When powering loads with significant dynamic current requirements, the voltage regulation at the point of load can be improved by addition of decoupling capacitors at the load. The most effective technique is to locate low ESR ceramic and electrolytic capacitors as close to the load as possible, using several parallel capacitors to lower the effective ESR. The ceramic capacitors will handle high-frequency dynamic load changes while the electrolytic capacitors are used to handle low frequency dynamic load changes. Ceramic capacitors will also reduce any high frequency noise at the load.

It is equally important to use low resistance and low inductance PCB layouts and cabling. If significant inductance are within the load distribution, >50% of the stated “Minimum Output Capacitance” shall be located at the module’s output.

External decoupling capacitors will become part of the control loop of the DC/DC converter and may affect the stability margins. As a “rule of thumb”, 100  $\mu$ F/A of output current can be added without any additional analysis. The ESR of the capacitors is a very important parameter. Flex Power Modules guarantee stable operation with a verified ESR value of >10 m $\Omega$  across the output connections.

|              | Minimum Input Capacitance | Minimum Output Capacitance |
|--------------|---------------------------|----------------------------|
| PKU 5310E PI | 47 $\mu$ F                | 220 $\mu$ F                |
| PKU 5311E PI | 47 $\mu$ F                | 150 $\mu$ F                |
| PKU 5313E PI | 47 $\mu$ F                | 47 $\mu$ F                 |
| PKU 5315E PI | 47 $\mu$ F                | 47 $\mu$ F                 |

Minimum capacitance

For further information please contact your local Flex Power Modules representative.

**PKU 5\$00E series DC/DC Converters**  
Input 18 - 72 V, Output up to 10 A / 35 W

EN/LZT 146 391 R5A September 2017

© Flex

## Operating information continued

### Output Voltage Adjust ( $V_{adj}$ )

The products have an Output Voltage Adjust pin ( $V_{adj}$ ). This pin can be used to adjust the output voltage above or below Output voltage initial setting.

When increasing the output voltage, the voltage at the output pins must be kept below the threshold of the over voltage protection, (OVP) to prevent the product from entering OVP. At increased output voltages the maximum power rating of the product remains the same, and the max output current must be decreased correspondingly.

To increase the voltage the resistor should be connected between the  $V_{adj}$  pin and +Out pin. The resistor value of the Output voltage adjust function is according to information given under the Output section for the respective product.

To decrease the output voltage, the resistor should be connected between the  $V_{adj}$  pin and -Out pin.

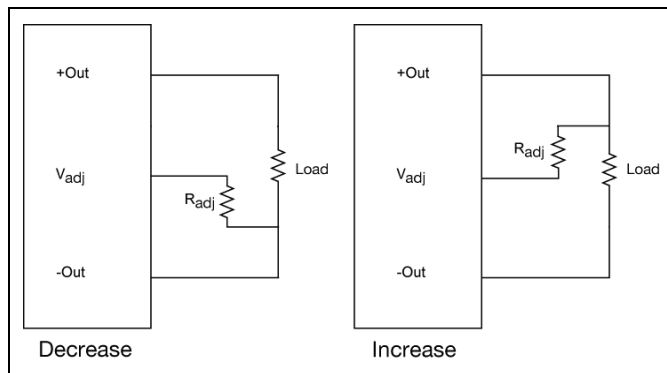

### Over Temperature Protection (OTP)

The converters are protected from thermal overload by an internal over temperature shutdown circuit.

When  $T_{P1}$  as defined in thermal consideration section reach exceeds  $105^{\circ}\text{C}$  the converter will shut down.

The DC/DC converter will make continuous attempts to start up (non-latching mode) and resume normal operation automatically when the hot-spot temperature has dropped  $10^{\circ}\text{C}$  below the temperature threshold.

### Over Voltage Protection (OVP)

The converters have output over voltage protection that will prevent output voltage to exceed the specified value in technical specification.

The converter will limit the output voltage to the maximum level. Converters will resume normal operation automatically after removal of the over voltage condition.

### Over Current Protection (OCP)

The converters include current limiting circuitry for protection at continuous overload.

The output voltage will decrease towards zero for output currents in excess of max output current (max  $I_o$ ).

After a time period exceeding 10 ms in OCP converters will enter hiccupmode to reduce average output power.

During short-circuit condition module temperature will increase rapidly and OTP function may be activated.

Module will not resume from hiccup shutdown period unless the temperature drops below the OTP re-activation temperature.

The converter will resume normal operation after removal of the overload. The load distribution should be designed for the maximum output short circuit current specified.

### Pre-bias Start-up

The product has a Pre-bias start up functionality and will not sink current during start up or RC-off if a pre-bias source with less than 75% of  $V_o$  is present at the output terminals.

Precaution must be taken that reverse current might be present if  $V_i$  is disabled. Without  $V_i$  a small current will discharge external capacitors.

**NB!** Feeding  $V_o$  from external power supply for test purpose might without  $V_i$  cause high reverse current.

**PKU 5\$00E series DC/DC Converters**  
 Input 18 - 72 V, Output up to 10 A / 35 W

EN/LZT 146 391 R5A September 2017

© Flex

### Thermal Consideration

#### General

The products are designed to operate in different thermal environments and sufficient cooling must be provided to ensure reliable operation.

For products mounted on a PCB without a heat sink attached, cooling is achieved mainly by conduction, from the pins to the host board, and convection, which is dependant on the airflow across the product. Increased airflow enhances the cooling of the product. The Output Current Derating graph found in the Output section for each model provides the available output current vs. ambient air temperature and air velocity at  $V_I = 53$  V.

The product is tested on a 254 x 254 mm, 35  $\mu$ m (1 oz), 8-layer test board mounted vertically in a wind tunnel with a cross-section of 608 x 203 mm.

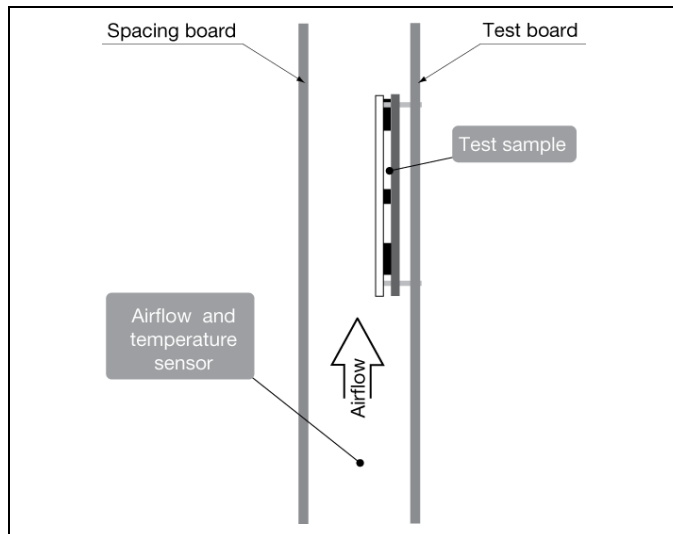

Proper cooling of the product can be verified by measuring the temperature at position P1. The temperature at this position should not exceed the max values provided in the table below. The number of points may vary with different thermal design and topology.

See Design Note 019 for further information.

| Position | Description  | Temp. limit |
|----------|--------------|-------------|
| P1       | Opto coupler | 95° C       |

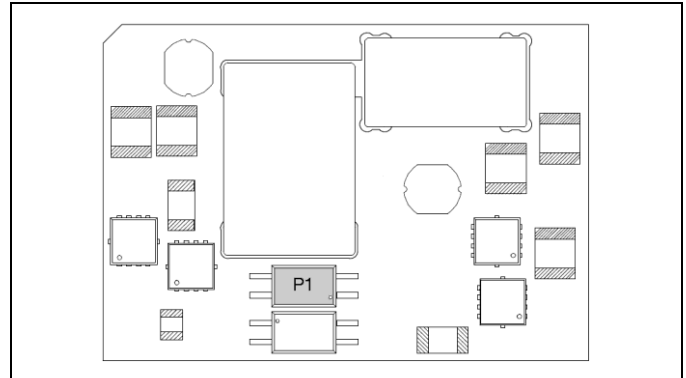

Open frame

#### Definition of reference temperature $T_{P1}$

The reference temperature is used to monitor the temperature limits of the product. Temperatures above maximum  $T_{P1}$ , measured at the reference point P1 are not allowed and may cause degradation or permanent damage to the product.  $T_{P1}$  is also used to define the temperature range for normal operating conditions.  $T_{P1}$  is defined by the design and used to guarantee safety margins, proper operation and high reliability of the product.

#### Connections

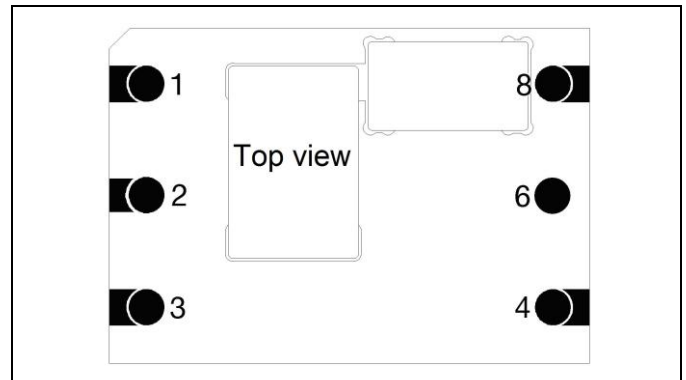

| Pin | Designation | Function              |
|-----|-------------|-----------------------|
| 1   | +In         | Positive Input        |
| 2   | RC          | Remote control        |
| 3   | -In         | Negative Input        |
| 4   | -Out        | Negative Output       |
| 6   | Vadj        | Output voltage adjust |
| 8   | +Out        | Positive Output       |

**PKU 5\$00E series DC/DC Converters**  
 Input 18 - 72 V, Output up to 10 A / 35 W

EN/LZT 146 391 R5A September 2017

© Flex

### Mechanical Information - Hole Mount, Open Frame Version

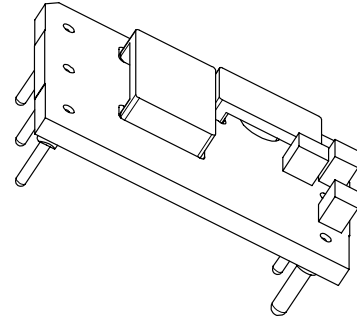
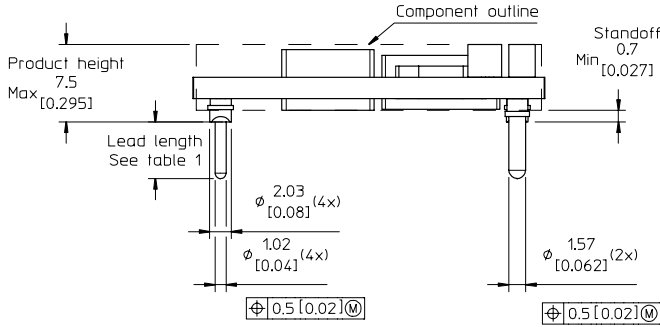

TOP VIEW

Pin positions according to the recommended footprint.

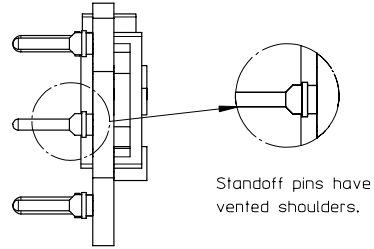
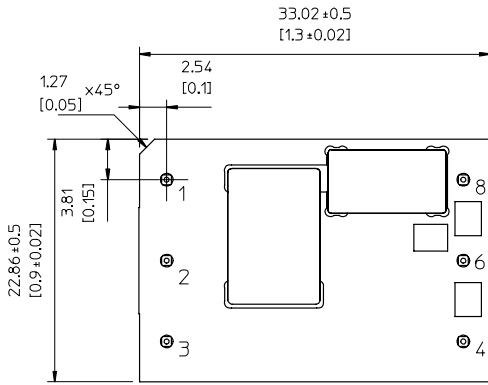

RECOMMENDED FOOTPRINT - TOP VIEW

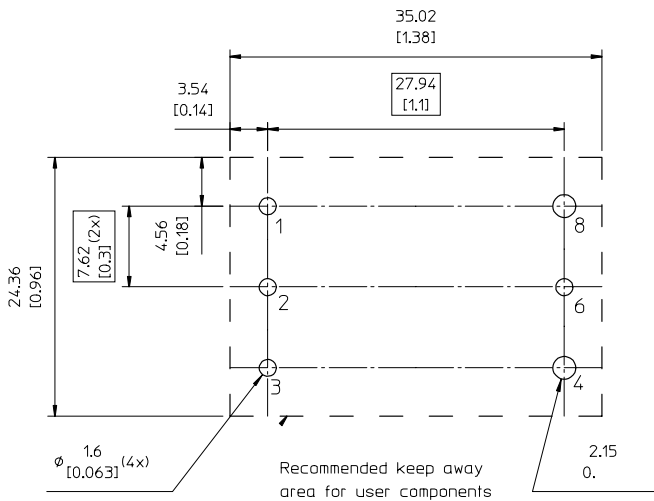

Table 1

| Pin option | Lead length        |
|------------|--------------------|
| Standard   | 5.33 [0.21]        |
| LA         | 3.69 [0.145] (cut) |
| LB         | 4.57 [0.18] (cut)  |

Pins:  
 Material: Copper alloy  
 Plating: Min 0.1  $\mu$ m Gold over 1-3  $\mu$ m Nickel.

Weight: typical 10 g

All dimensions in mm [inch].  
 Tolerances unless specified  
 X.x mm  $\pm$ 0.5 mm [0.02]  
 X.xx mm  $\pm$ 0.25 mm [0.01]  
 (not applied on footprint or typical values)



**PKU 5\$00E series DC/DC Converters**  
 Input 18 - 72 V, Output up to 10 A / 35 W

EN/LZT 146 391 R5A September 2017

© Flex

**Mechanical Information - Surface Mount Version**

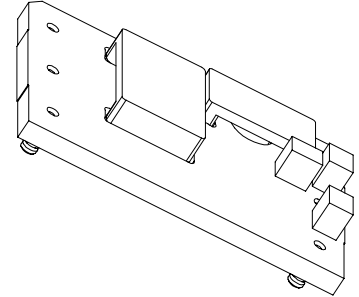
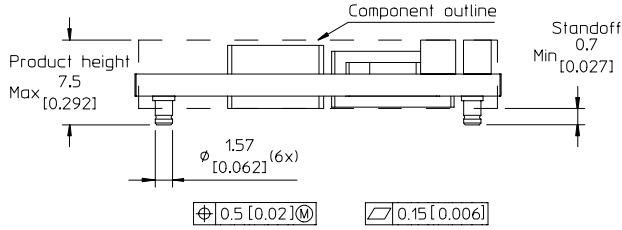

TOP VIEW

Pin positions according to the recommended footprint

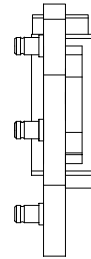
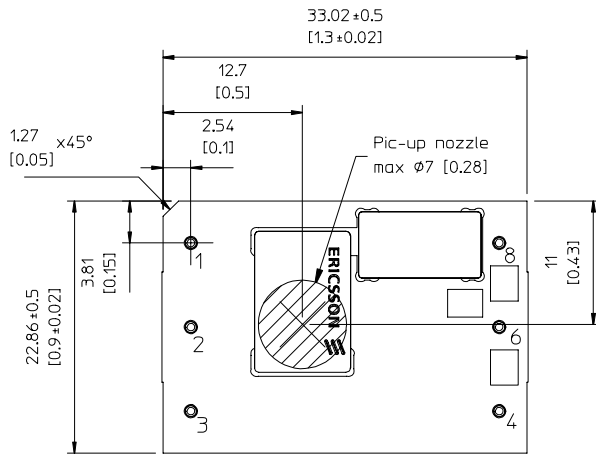

RECOMMENDED FOOTPRINT - TOP VIEW

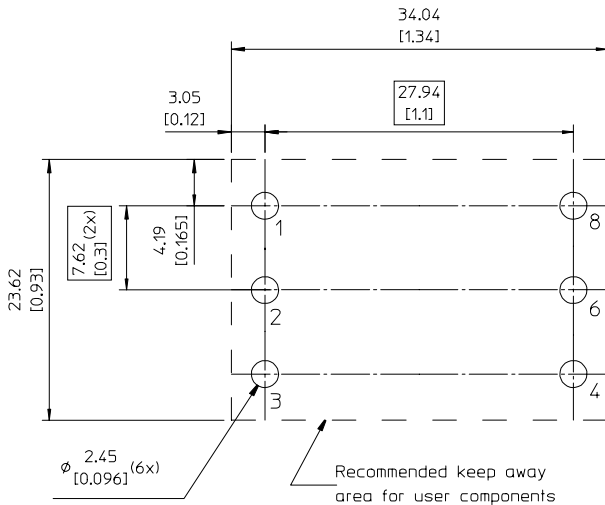

Layout considerations:

Use sufficient numbers of vias connected to output pin pads for proper thermal and current conductivity.

Pins:

Material: Copper alloy  
 Plating: Min 0.1 μm Gold over 1-3 μm Nickel.

Weight: typical 10 g

All dimensions in mm [inch].  
 Tolerances unless specified

X.x mm ±0.5 mm [0.02]

X.xx mm ±0.25 mm [0.01]

(not applied on footprint or typical values)



**PKU 5\$00E series DC/DC Converters**  
 Input 18 - 72 V, Output up to 10 A / 35 W

EN/LZT 146 391 R5A September 2017

© Flex

### Soldering Information - Surface Mounting

The surface mount product is intended for forced convection or vapor phase reflow soldering in SnPb or Pb-free processes.

The reflow profile should be optimised to avoid excessive heating of the product. It is recommended to have a sufficiently extended preheat time to ensure an even temperature across the host PCB and it is also recommended to minimize the time in reflow.

A no-clean flux is recommended to avoid entrapment of cleaning fluids in cavities inside the product or between the product and the host board, since cleaning residues may affect long time reliability and isolation voltage.

### Minimum Pin Temperature Recommendations

Pin number 8 is chosen as reference location for the minimum pin temperature recommendation since this will likely be the coolest solder joint during the reflow process.

#### SnPb solder processes

For SnPb solder processes, a pin temperature ( $T_{PIN}$ ) in excess of the solder melting temperature, ( $T_L$ , 183°C for Sn63Pb37) for more than 30 seconds and a peak temperature of 210°C is recommended to ensure a reliable solder joint.

#### Lead-free (Pb-free) solder processes

For Pb-free solder processes, a pin temperature ( $T_{PIN}$ ) in excess of the solder melting temperature ( $T_L$ , 217 to 221°C for SnAgCu solder alloys) for more than 30 seconds and a peak temperature of 235°C on all solder joints is recommended to ensure a reliable solder joint.

| General reflow process specifications         |               | SnPb eutectic | Pb-free   |
|---|---------------|---------------|-----------|
| Average ramp-up ( $T_{PRODUCT}$ )             |               | 3°C/s max     | 3°C/s max |
| Typical solder melting (liquidus) temperature | $T_L$         | 183°C         | 221°C     |
| Minimum reflow time above $T_L$               |               | 30 s          | 30 s      |
| Minimum pin temperature                       | $T_{PIN}$     | 210°C         | 235°C     |
| Max product temperature                       | $T_{PRODUCT}$ | 225°C         | 260°C     |
| Average ramp-down ( $T_{PRODUCT}$ )           |               | 6°C/s max     | 6°C/s max |
| Maximum time 25°C to peak                     |               | 6 minutes     | 8 minutes |

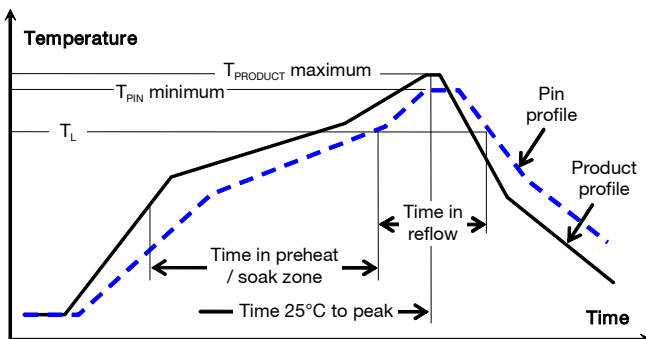

### Maximum Product Temperature Requirements

Top of the product PCB near pin 2 is chosen as reference location for the maximum (peak) allowed product temperature ( $T_{PRODUCT}$ ) since this will likely be the warmest part of the product during the reflow process.

#### SnPb solder processes

For SnPb solder processes, the product is qualified for MSL 1 according to IPC/JEDEC standard J-STD-020C.

During reflow  $T_{PRODUCT}$  must not exceed 225 °C at any time.

#### Pb-free solder processes

For Pb-free solder processes, the product is qualified for MSL 3 according to IPC/JEDEC standard J-STD-020C.

During reflow  $T_{PRODUCT}$  must not exceed 260 °C at any time.

### Dry Pack Information

Products intended for Pb-free reflow soldering processes are delivered in standard moisture barrier bags according to IPC/JEDEC standard J-STD-033 (Handling, packing, shipping and use of moisture/reflow sensitivity surface mount devices).

Using products in high temperature Pb-free soldering processes requires dry pack storage and handling. In case the products have been stored in an uncontrolled environment and no longer can be considered dry, the modules must be baked according to J-STD-033.

### Thermocoupler Attachment

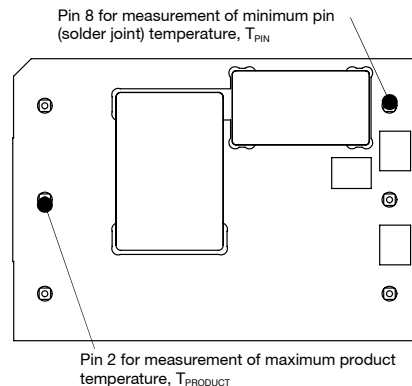

**PKU 5\$00E series DC/DC Converters**  
 Input 18 - 72 V, Output up to 10 A / 35 W

EN/LZT 146 391 R5A September 2017

© Flex

### Soldering Information - Hole Mounting

The hole mounted product is intended for plated through hole mounting by wave or manual soldering. The pin temperature is specified to maximum to 270°C for maximum 10 seconds.

A maximum preheat rate of 4°C/s and maximum preheat temperature of 150°C is suggested. When soldering by hand, care should be taken to avoid direct contact between the hot soldering iron tip and the pins for more than a few seconds in order to prevent overheating.

A no-clean flux is recommended to avoid entrapment of cleaning fluids in cavities inside the product or between the product and the host board. The cleaning residues may affect long time reliability and isolation voltage.

### Delivery Package Information

The surface mount products are delivered in antistatic injection molded trays (Jedec design guide 4.10D standard) and in antistatic carrier tape (EIA 481 standard).

The through-hole mount products are delivered in antistatic injection molded trays (Jedec design guide 4.10D standard).

| Tray Specifications       |  |
|---------------------------|--|
| <b>Material</b>           | Antistatic PPE                                       |
| <b>Surface resistance</b> | $10^5 < \text{Ohm/square} < 10^{12}$                 |
| <b>Bakability</b>         | The trays can be baked at maximum 125°C for 48 hours |
| <b>Tray thickness</b>     | 18.5 mm [0.728 inch]                                 |
| <b>Tray capacity</b>      | 30 products/tray                                     |
| <b>Tray weight</b>        | 190 g empty, 500 g full tray                         |

| Carrier Tape Specifications        |                            |
|------------------------------------|----------------------------|
| <b>Material</b>                    | Antistatic PS              |
| <b>Surface resistance</b>          | $10^7 < \text{Ohm/square}$ |
| <b>Bakeability</b>                 | The tape is not bakable    |
| <b>Tape width, W</b>               | 56 mm [2.2 inch]           |
| <b>Pocket pitch, P<sub>1</sub></b> | 36 mm [1.42 inch]          |
| <b>Pocket depth, K<sub>0</sub></b> | 8.7 mm [0.343 inch]        |
| <b>Reel diameter</b>               | 380 mm [15 inch]           |
| <b>Reel capacity</b>               | 200 products /reel         |
| <b>Reel weight</b>                 | 2.3 kg/full reel           |

EIA standard carrier tape

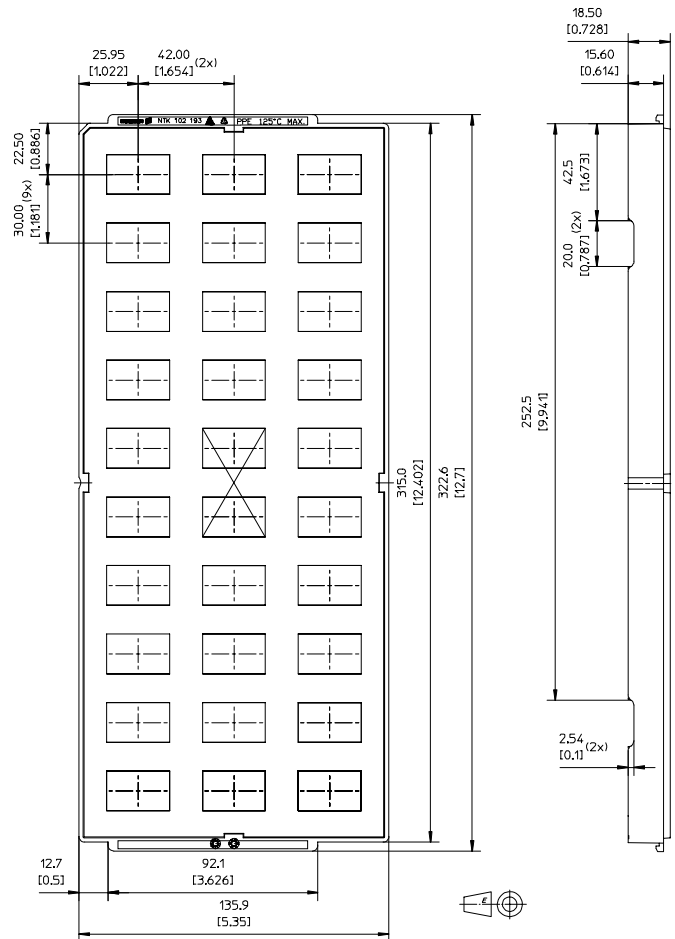
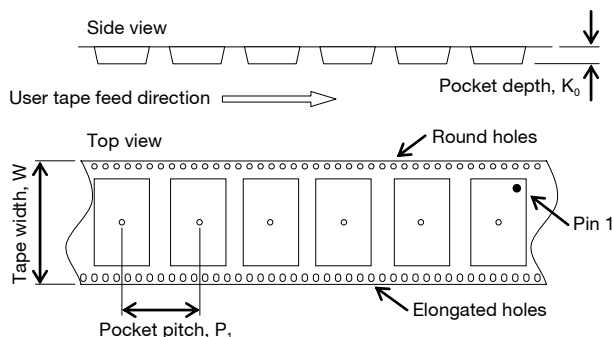

X = Vacuum pick up  
 All dimensions in mm [inch]  
 Tolerances: X.xx mm  $\pm 0.13$  mm [0.005], X.x mm  $\pm 0.26$  mm [0.01]  
 Note: tray dimensions refer to pocket center. For exact location of product pick up surface, refer to mechanical drawing.



**PKU 5\$00E series DC/DC Converters**  
 Input 18 - 72 V, Output up to 10 A / 35 W

EN/LZT 146 391 R5A September 2017

© Flex

**Product Qualification Specification**

| Characteristics                             |  |   |   |
|---|--|---|---|
| External visual inspection                  | IPC-A-610  |   |   |
| Change of temperature (Temperature cycling) | IEC 60068-2-14 Na  | Temperature range<br>Number of cycles<br>Dwell/transfer time          | -40 to 100°C<br>1000<br>15 min/0-1 min                              |
| Cold (in operation)                         | IEC 60068-2-1 Ad   | Temperature T <sub>A</sub><br>Duration                                | -45°C<br>72 h   |
| Damp heat                                   | IEC 60068-2-67 Cy  | Temperature<br>Humidity<br>Duration                                   | 85°C<br>85 % RH<br>1000 hours                                       |
| Dry heat                                    | IEC 60068-2-2 Bd   | Temperature<br>Duration   | 125°C<br>1000 h   |
| Electrostatic discharge susceptibility      | IEC 61340-3-1, JESD 22-A114<br>IEC 61340-3-2, JESD 22-A115 | Human body model (HBM)<br>Machine Model (MM)                          | Class 1C, 1000 V<br>Class 3, 200 V                                  |
| Immersion in cleaning solvents              | IEC 60068-2-45 XA, method 2                                | Water<br>Glycol ether<br>Isopropyl alcohol                            | 55°C<br>35°C<br>35°C  |
| Mechanical shock                            | IEC 60068-2-27 Ea  | Peak acceleration<br>Duration   | 100 g<br>6 ms   |
| Moisture reflow sensitivity <sup>1</sup>    | J-STD-020C   | Level 1 (SnPb-eutectic)<br>Level 3 (Pb Free)                          | 225°C<br>260°C  |
| Operational life test                       | MIL-STD-202G, method 108A                                  | Duration  | 1000 h  |
| Resistance to soldering heat <sup>2</sup>   | IEC 60068-2-20 Tb, method 1A                               | Solder temperature<br>Duration  | 270°C<br>10-13 s  |
| Robustness of terminations                  | IEC 60068-2-21 Test Ua1<br>IEC 60068-2-21 Test Ue1         | Through hole mount products<br>Surface mount products                 | All leads<br>All leads  |
| Solderability                               | IEC 60068-2-58 test Td <sup>1</sup>                        | Preconditioning<br>Temperature, SnPb Eutectic<br>Temperature, Pb-free | 150°C dry bake 16 h<br>215°C<br>235°C                               |
|   | IEC 60068-2-20 test Ta <sup>2</sup>                        | Preconditioning<br>Temperature, SnPb Eutectic<br>Temperature, Pb-free | Steam ageing<br>235°C<br>245°C                                      |
| Vibration, broad band random                | IEC 60068-2-64 Fh, method 1                                | Frequency<br>Spectral density<br>Duration                             | 10 to 500 Hz<br>0.07 g <sup>2</sup> /Hz<br>10 min in each direction |

**Notes**
<sup>1</sup> Only for products intended for reflow soldering (surface mount products)

<sup>2</sup> Only for products intended for wave soldering (plated through hole products)



Компания «ЭлектроПласт» предлагает заключение долгосрочных отношений при поставках импортных электронных компонентов на взаимовыгодных условиях!

Наши преимущества:

- Оперативные поставки широкого спектра электронных компонентов отечественного и импортного производства напрямую от производителей и с крупнейших мировых складов;
- Поставка более 17-ти миллионов наименований электронных компонентов;
- Поставка сложных, дефицитных, либо снятых с производства позиций;
- Оперативные сроки поставки под заказ (от 5 рабочих дней);
- Экспресс доставка в любую точку России;
- Техническая поддержка проекта, помощь в подборе аналогов, поставка прототипов;
- Система менеджмента качества сертифицирована по Международному стандарту ISO 9001;
- Лицензия ФСБ на осуществление работ с использованием сведений, составляющих государственную тайну;
- Поставка специализированных компонентов (Xilinx, Altera, Analog Devices, Intersil, Interpoint, Microsemi, Aeroflex, Peregrine, Syfer, Eurofarad, Texas Instrument, Miteq, Cobham, E2V, MA-COM, Hittite, Mini-Circuits, General Dynamics и др.);

Помимо этого, одним из направлений компании «ЭлектроПласт» является направление «Источники питания». Мы предлагаем Вам помощь Конструкторского отдела:

- Подбор оптимального решения, техническое обоснование при выборе компонента;
- Подбор аналогов;
- Консультации по применению компонента;
- Поставка образцов и прототипов;
- Техническая поддержка проекта;
- Защита от снятия компонента с производства.



#### Как с нами связаться

**Телефон:** 8 (812) 309 58 32 (многоканальный)

**Факс:** 8 (812) 320-02-42

**Электронная почта:** [org@eplast1.ru](mailto:org@eplast1.ru)

**Адрес:** 198099, г. Санкт-Петербург, ул. Калинина, дом 2, корпус 4, литера А.