



Reference Specification

Type RB
Safety Standard Certified Lead Type Disc Ceramic Capacitors for General Purpose

Product specifications in this catalog are as of Jun. 2019, and are subject to change or obsolescence without notice.
Please consult the approval sheet before ordering. Please read rating and Cautions first.

Reference only

⚠ CAUTION

1. OPERATING VOLTAGE

When DC-rated capacitors are to be used in AC or ripple current circuits, be sure to maintain the V_{p-p} value of the applied voltage or the V_{o-p} which contains DC bias within the rated voltage range. When the voltage is started to apply to the circuit or it is stopped applying, the irregular voltage may be generated for a transit period because of resonance or switching. Be sure to use a capacitor within rated voltage containing these irregular voltage.

Voltage	DC Voltage	DC+AC Voltage	AC Voltage	Pulse Voltage(1)	Pulse Voltage(2)
Positional Measurement					

2. OPERATING TEMPERATURE AND SELF-GENERATED HEAT

Keep the surface temperature of a capacitor below the upper limit of its rated operating temperature range. Be sure to take into account the heat generated by the capacitor itself.

When the capacitor is used in a high-frequency current, pulse current or the like, it may have the self-generated heat due to dielectric-loss. Applied voltage should be the load such as self-generated heat is within 20 °C on the condition of atmosphere temperature 25 °C. When measuring, use a thermocouple of small thermal capacity-K of $\phi 0.1\text{mm}$ and be in the condition where capacitor is not affected by radiant heat of other components and wind of surroundings. Excessive heat may lead to deterioration of the capacitor's characteristics and reliability. (Never attempt to perform measurement with the cooling fan running. Otherwise, accurate measurement cannot be ensured.)

3. TEST CONDITION FOR WITHSTANDING VOLTAGE

(1) TEST EQUIPMENT

Test equipment for AC withstanding voltage should be used with the performance of the wave similar to 50/60 Hz sine wave.

If the distorted sine wave or over load exceeding the specified voltage value is applied, the defective may be caused.

(2) VOLTAGE APPLIED METHOD

When the withstanding voltage is applied, capacitor's lead or terminal should be firmly connected to the out-put of the withstanding voltage test equipment, and then the voltage should be raised from near zero to the test voltage.

If the test voltage without the raise from near zero voltage would be applied directly to capacitor, test voltage should be applied with the *zero cross. At the end of the test time, the test voltage should be reduced to near zero, and then capacitor's lead or terminal should be taken off the out-put of the withstanding voltage test equipment.

If the test voltage without the raise from near zero voltage would be applied directly to capacitor, the surge voltage may arise, and therefore, the defective may be caused.

*ZERO CROSS is the point where voltage sine wave pass 0V.

- See the right figure -

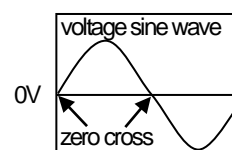

4. FAIL-SAFE

When capacitor would be broken, failure may result in a short circuit. Be sure to provide an appropriate fail-safe function like a fuse on your product if failure would follow an electric shock, fire or fume.

5. VIBRATION AND IMPACT

Do not expose a capacitor or its leads to excessive shock or vibration during use.

6. SOLDERING

When soldering this product to a PCB/PWB, do not exceed the solder heat resistance specification of the capacitor. Subjecting this product to excessive heating could melt the internal junction solder and may result in thermal shocks that can crack the ceramic element.

When soldering capacitor with a soldering iron, it should be performed in following conditions.

Temperature of iron-tip : 400 °C max.

Soldering iron wattage : 50W max.

Soldering time : 3.5s max.

7. BONDING, RESIN MOLDING AND COATING

In case of bonding, molding or coating this product, verify that these processes do not affect the quality of capacitor by testing the performance of the bonded, molded or coated product in the intended equipment.

In case of the amount of applications, dryness / hardening conditions of adhesives and molding resins containing organic solvents (ethyl acetate, methyl ethyl ketone, toluene, etc.) are unsuitable, the outer coating resin of a capacitor is damaged by the organic solvents and it may result, worst case, in a short circuit.

The variation in thickness of adhesive, molding resin or coating may cause a outer coating resin cracking and/or ceramic element cracking of a capacitor in a temperature cycling.

8. TREATMENT AFTER BONDING, RESIN MOLDING AND COATING

When the outer coating is hot (over 100 °C) after soldering, it becomes soft and fragile.

So please be careful not to give it mechanical stress.

Failure to follow the above cautions may result, worst case, in a short circuit and cause fuming or partial dispersion when the product is used.

9. OPERATING AND STORAGE ENVIRONMENT

The insulating coating of capacitors does not form a perfect seal; therefore, do not use or store capacitors in a corrosive atmosphere, especially where chloride gas, sulfide gas, acid, alkali, salt or the like are present. And avoid exposure to moisture. Before cleaning, bonding, or molding this product, verify that these processes do not affect product quality by testing the performance of a cleaned, bonded or molded product in the intended equipment. Store the capacitors where the temperature and relative humidity do not exceed -10 to 40 °C and 15 to 85%.

Use capacitors within 6 months after delivered. Check the solderability after 6 months or more.

10. LIMITATION OF APPLICATIONS

Please contact us before using our products for the applications listed below which require especially high reliability for the prevention of defects which might directly cause damage to the third party's life, body or property.

1. Aircraft equipment
2. Aerospace equipment
3. Undersea equipment
4. Power plant control equipment
5. Medical equipment
6. Transportation equipment (vehicles, trains, ships, etc.)
7. Traffic signal equipment
8. Disaster prevention / crime prevention equipment
9. Data-processing equipment exerting influence on public
10. Application of similar complexity and/or reliability requirements to the applications listed in the above.

NOTICE

1. CLEANING (ULTRASONIC CLEANING)

To perform ultrasonic cleaning, observe the following conditions.

Rinse bath capacity : Output of 20 watts per liter or less.

Rinsing time : 5 min maximum.

Do not vibrate the PCB/PWB directly.

Excessive ultrasonic cleaning may lead to fatigue destruction of the lead wires.

2. CAPACITANCE CHANGE OF CAPACITORS

· Class 1 capacitors

Capacitance might change a little depending on a surrounding temperature or an applied voltage.

Please contact us if you use for the strict time constant circuit.

· Class 2 and 3 capacitors

Class 2 and 3 capacitors like temperature characteristic B, E and F have an aging characteristic, whereby the capacitor continually decreases its capacitance slightly if the capacitor leaves for a long time. Moreover, capacitance might change greatly depending on a surrounding temperature or an applied voltage. So, it is not likely to be able to use for the time constant circuit.

Please contact us if you need a detail information.

3. PERFORMANCE CHECK BY EQUIPMENT

Before using a capacitor, check that there is no problem in the equipment's performance and the specifications.

Generally speaking, CLASS 2 ceramic capacitors have voltage dependence characteristics and temperature dependence characteristics in capacitance. So, the capacitance value may change depending on the operating condition in a equipment. Therefore, be sure to confirm the apparatus performance of receiving influence in a capacitance value change of a capacitor, such as leakage current and noise suppression characteristic.

Moreover, check the surge-proof ability of a capacitor in the equipment, if needed, because the surge voltage may exceed specific value by the inductance of the circuit.

 **NOTE**

1. Please make sure that your product has been evaluated in view of your specifications with our product being mounted to your product.

2. You are requested not to use our product deviating from this specification.

Reference only

1. Application

This specification is applied to Safety Standard Certified Lead Type Disc Ceramic Capacitors Type RB used for General Electric equipment.

Type RB is Safety Standard Certified capacitors of Class X1,Y1.

Do not use these products in any automotive power train or safety equipment including battery chargers for electric vehicles and plug-in hybrids.

Approval standard and certified number

	Standard number	*Certified number	AC Rated volt. V(r.m.s.)
UL/cUL	UL60384-14	E37921	X1:760 Y1:500
ENEC (VDE)	DIN60384-14 EN60384-14 IEC60384-14	40046675	
CQC	IEC60384-14	CQC17001178139	

*Above Certified number may be changed on account of the revision of standards and the renewal of certification.

2. Rating

2-1. Operating temperature range -40 ~ +125°C

2-2. Rated Voltage X1:AC760V(r.m.s.)
Y1:AC500V(r.m.s.)

2-3. Part number configuration

ex.) DE1 B3 RB 471 K A4 B R01F
Product code Temperature characteristic Type name Capacitance Capacitance tolerance Lead code Packing style code Individual specification

- Product code
DE1 denotes X1,Y1 class .

- Temperature characteristic

Code	Temperature characteristic
1X	SL
B3	B
E3	E

Please confirm detailed specification on [Specification and test methods].

- Type name
This denotes safety certified type name Type RB.

Reference only

- Capacitance
The first two digits denote significant figures ; the last digit denotes the multiplier of 10 in pF.
ex.) In case of 471.
 $47 \times 10^1 = 470\text{pF}$

- Capacitance tolerance
Please refer to [Part number list].

- Lead code

Code	Lead style
A*	Vertical crimp long type
J*	Vertical crimp short type
N*	Vertical crimp taping type

* Please refer to [Part number list]

- Packing style code

Code	Packing type
B	Bulk type
A	Ammo pack taping type

- Individual specification

In case part number cannot be identified without 'individual specification', it is added at the end of part number.

Code	Specification
R01F	<ul style="list-style-type: none"> ▸ Rated voltage : X1:AC760V(r.m.s.) Y1:AC500V(r.m.s.) ▸ Halogen free (Br ≤ 900ppm, Cl ≤ 900ppm) (Br + Cl ≤ 1500ppm) ▸ CP wire

Note) Murata part numbers might be changed depending on lead code or any other changes. Therefore, please specify only the type name(RB) and capacitance of products in the parts list when it is required for applying safety standard of electric equipment.

Reference only

3. Marking

Type name	: RB
Nominal capacitance	: Actual value(under 100pF) 3 digit system(100pF and over)
Capacitance tolerance	: Code
Class code and Rated voltage mark	: X1 760~ Y1 500~
Manufacturing year	: Letter code(The last digit of A.D. year.)
Manufacturing month	: Code (Feb./Mar. → 2 Aug./Sep. → 8 Apr./May → 4 Oct./Nov. → O Jun./Jul. → 6 Dec./Jan. → D)
Company name code	: M15 (Made in Thailand)

(Example)

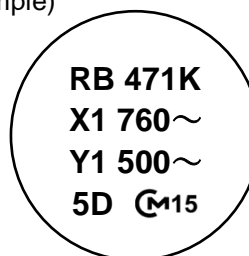

Reference only

4. Part number list

·Vertical crimp long type
(Lead code:A*)

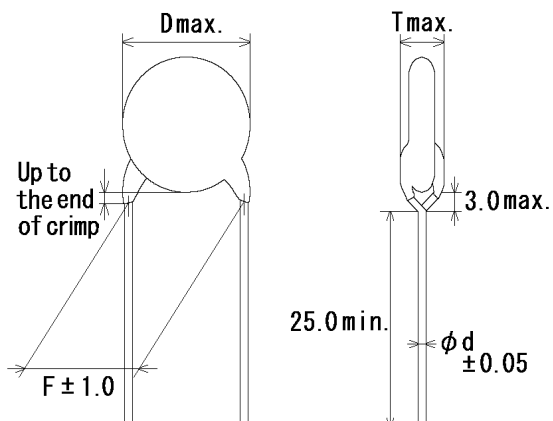

Note) The mark '*' of lead code differ from lead spacing(F) and lead diameter(d).
Please see the following list about details.

Unit : mm

T.C.	Cap. (pF)	Cap. tol.	Customer Part Number	Murata Part Number	Dimension (mm)				Lead code	Pack qty. (pcs)
					D	T	F	d		
SL	10	± 10%		DE11XRB100KA4BR01F	8.0	5.0	10.0	0.6	A4	250
SL	15	± 10%		DE11XRB150KA4BR01F	6.0	6.0	10.0	0.6	A4	500
SL	22	± 10%		DE11XRB220KA4BR01F	6.0	5.0	10.0	0.6	A4	500
SL	33	± 10%		DE11XRB330KA4BR01F	7.0	5.0	10.0	0.6	A4	250
SL	47	± 10%		DE11XRB470KA4BR01F	8.0	5.0	10.0	0.6	A4	250
SL	68	± 10%		DE11XRB680KA4BR01F	9.0	5.0	10.0	0.6	A4	250
B	100	± 10%		DE1B3RB101KA4BR01F	6.0	5.0	10.0	0.6	A4	500
B	150	± 10%		DE1B3RB151KA4BR01F	8.0	5.0	10.0	0.6	A4	250
B	220	± 10%		DE1B3RB221KA4BR01F	6.0	6.0	10.0	0.6	A4	500
B	330	± 10%		DE1B3RB331KA4BR01F	7.0	6.0	10.0	0.6	A4	250
B	470	± 10%		DE1B3RB471KA4BR01F	8.0	6.0	10.0	0.6	A4	250
B	680	± 10%		DE1B3RB681KA4BR01F	9.0	6.0	10.0	0.6	A4	250
E	1000	± 20%		DE1E3RB102MA4BR01F	8.0	6.0	10.0	0.6	A4	250
E	1500	± 20%		DE1E3RB152MA4BR01F	9.0	6.0	10.0	0.6	A4	250
E	2200	± 20%		DE1E3RB222MA4BR01F	11.0	6.0	10.0	0.6	A4	250
E	3300	± 20%		DE1E3RB332MA4BR01F	13.0	6.0	10.0	0.6	A4	200
E	4700	± 20%		DE1E3RB472MA4BR01F	14.0	6.0	10.0	0.6	A4	200

Reference only

-Vertical crimp short type
(Lead code: J*)

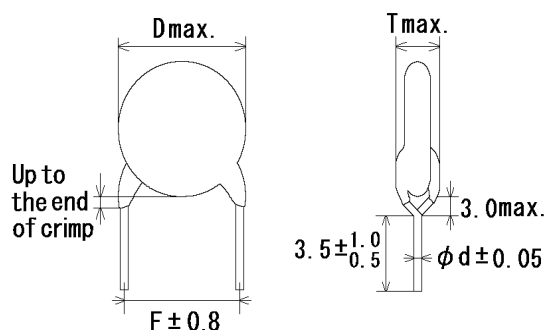

Note) The mark '*' of lead code differ from lead spacing(F) and lead diameter(d).
Please see the following list about details.

Unit : mm

T.C.	Cap. (pF)	Cap. tol.	Customer Part Number	Murata Part Number	Dimension (mm)				Lead code	Pack qty. (pcs)
					D	T	F	d		
SL	10	± 10%		DE11XRB100KJ4BR01F	8.0	5.0	10.0	0.6	J4	500
SL	15	± 10%		DE11XRB150KJ4BR01F	6.0	6.0	10.0	0.6	J4	500
SL	22	± 10%		DE11XRB220KJ4BR01F	6.0	5.0	10.0	0.6	J4	500
SL	33	± 10%		DE11XRB330KJ4BR01F	7.0	5.0	10.0	0.6	J4	500
SL	47	± 10%		DE11XRB470KJ4BR01F	8.0	5.0	10.0	0.6	J4	500
SL	68	± 10%		DE11XRB680KJ4BR01F	9.0	5.0	10.0	0.6	J4	500
B	100	± 10%		DE1B3RB101KJ4BR01F	6.0	5.0	10.0	0.6	J4	500
B	150	± 10%		DE1B3RB151KJ4BR01F	8.0	5.0	10.0	0.6	J4	500
B	220	± 10%		DE1B3RB221KJ4BR01F	6.0	6.0	10.0	0.6	J4	500
B	330	± 10%		DE1B3RB331KJ4BR01F	7.0	6.0	10.0	0.6	J4	500
B	470	± 10%		DE1B3RB471KJ4BR01F	8.0	6.0	10.0	0.6	J4	500
B	680	± 10%		DE1B3RB681KJ4BR01F	9.0	6.0	10.0	0.6	J4	500
E	1000	± 20%		DE1E3RB102MJ4BR01F	8.0	6.0	10.0	0.6	J4	500
E	1500	± 20%		DE1E3RB152MJ4BR01F	9.0	6.0	10.0	0.6	J4	500
E	2200	± 20%		DE1E3RB222MJ4BR01F	11.0	6.0	10.0	0.6	J4	500
E	3300	± 20%		DE1E3RB332MJ4BR01F	13.0	6.0	10.0	0.6	J4	250
E	4700	± 20%		DE1E3RB472MJ4BR01F	14.0	6.0	10.0	0.6	J4	250

Reference only

·Vartical crimp taping type
(Lead code:N*)



Note) The mark '*' of lead code differ from lead spacing(F), lead diameter(d) and pitch of component(P). Please see the following list or taping specification about details.

Unit : mm

T.C.	Cap. (pF)	Cap. tol.	Customer Part Number	Murata Part Number	Dimension (mm)					Lead code	Pack qty. (pcs)
					D	T	F	d	P		
SL	10	±10%		DE11XRB100KN4AR01F	8.0	5.0	10.0	0.6	25.4	N4	500
SL	15	±10%		DE11XRB150KN4AR01F	6.0	6.0	10.0	0.6	25.4	N4	500
SL	22	±10%		DE11XRB220KN4AR01F	6.0	5.0	10.0	0.6	25.4	N4	500
SL	33	±10%		DE11XRB330KN4AR01F	7.0	5.0	10.0	0.6	25.4	N4	500
SL	47	±10%		DE11XRB470KN4AR01F	8.0	5.0	10.0	0.6	25.4	N4	500
SL	68	±10%		DE11XRB680KN4AR01F	9.0	5.0	10.0	0.6	25.4	N4	500
B	100	±10%		DE1B3RB101KN4AR01F	6.0	5.0	10.0	0.6	25.4	N4	500
B	150	±10%		DE1B3RB151KN4AR01F	8.0	5.0	10.0	0.6	25.4	N4	500
B	220	±10%		DE1B3RB221KN4AR01F	6.0	6.0	10.0	0.6	25.4	N4	500
B	330	±10%		DE1B3RB331KN4AR01F	7.0	6.0	10.0	0.6	25.4	N4	500
B	470	±10%		DE1B3RB471KN4AR01F	8.0	6.0	10.0	0.6	25.4	N4	500
B	680	±10%		DE1B3RB681KN4AR01F	9.0	6.0	10.0	0.6	25.4	N4	500
E	1000	±20%		DE1E3RB102MN4AR01F	8.0	6.0	10.0	0.6	25.4	N4	500
E	1500	±20%		DE1E3RB152MN4AR01F	9.0	6.0	10.0	0.6	25.4	N4	500
E	2200	±20%		DE1E3RB222MN4AR01F	11.0	6.0	10.0	0.6	25.4	N4	500
E	3300	±20%		DE1E3RB332MN4AR01F	13.0	6.0	10.0	0.6	25.4	N4	500
E	4700	±20%		DE1E3RB472MN4AR01F	14.0	6.0	10.0	0.6	25.4	N4	500

Reference only

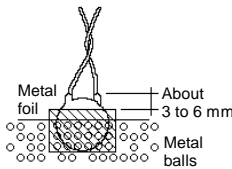
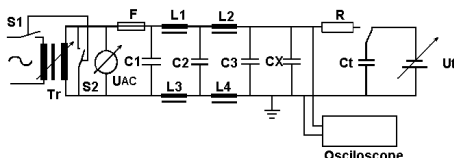
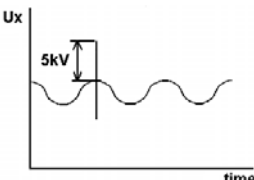
5. Specification and test methods												
No.	Item	Specification	Test method									
1	Appearance and dimensions	No marked defect on appearance form. Please refer to [Part number list] on dimensions.	The capacitor should be inspected by naked eyes for visible evidence of defect. Dimensions should be measured with slide calipers.									
2	Marking	To be easily legible.	The capacitor should be inspected by naked eyes.									
3	Dielectric strength	Between lead wires No failure.	The capacitor should not be damaged when AC4000V(r.m.s.)<50/60Hz> is applied between the lead wires for 60 s.									
		Body insulation No failure.	<p>First, the terminals of the capacitor should be connected together. Then, a metal foil should be closely wrapped around the body of the capacitor to the distance of about 3 to 6mm from each terminal.</p>  <p>Then, the capacitor should be inserted into a container filled with metal balls of about 1mm diameter. Finally, AC4000V (r.m.s.)<50/60Hz> is applied for 60 s between the capacitor lead wires and metal balls.</p>									
4	Insulation Resistance (I.R.)	10 000MΩ min.	The insulation resistance should be measured with DC500±50V within 60±5 s of charging. The voltage should be applied to the capacitor through a resistor of 1MΩ.									
5	Capacitance	Within specified tolerance.	The capacitance should be measured at 20°C with 1±0.1kHz and AC1±0.2V(r.m.s.) max..									
6	Dissipation Factor (D.F.)	2.5% max.	The dissipation factor should be measured at 20°C with 1±0.1kHz and AC1±0.2V(r.m.s.) max..									
7	Temperature characteristic	Char. SL : +350 to -1000 ppm/°C (Temp. range : +20 to +85°C) Char. B : Within ±10 % Char. E : Within +20/-55% (Temp. range : -25 to +85°C)	The capacitance measurement should be made at each step specified in Table.									
		<table border="1" style="margin: auto;"> <thead> <tr> <th>Step</th> <th>1</th> <th>2</th> <th>3</th> <th>4</th> <th>5</th> </tr> </thead> <tbody> <tr> <td>Temp.(°C)</td> <td>20±2</td> <td>-25±2</td> <td>20±2</td> <td>85±2</td> <td>20±2</td> </tr> </tbody> </table>		Step	1	2	3	4	5	Temp.(°C)	20±2	-25±2
Step	1	2	3	4	5							
Temp.(°C)	20±2	-25±2	20±2	85±2	20±2							
8	Active flammability	The cheese-cloth should not be on fire.	<p>The capacitors should be individually wrapped in at least one but more than two complete layers of cheese-cloth. The capacitor should be subjected to 20 discharges. The interval between successive discharges should be 5 s. The UAc should be maintained for 2min after the last discharge.</p>  <p> C1,2 : 1μF±10%, C3 : 0.033μF±5% 10kV L1 to L4 : 1.5mH±20% 16A Rod core choke R : 100Ω±2%, Ct : 3μF±5% 10kV UAc : UR ±5% UR : Rated voltage Cx : Capacitor under test F : Fuse, Rated 10A Ut : Voltage applied to Ct </p> 									

Reference only

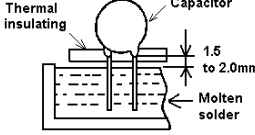
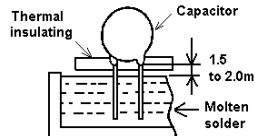
No.	Item	Specification	Test method
9	Robustness of terminations	Tensile	<p>Lead wire should not cut off. Capacitor should not be broken.</p> <p>Fix the body of capacitor, a tensile weight gradually to each lead wire in the radial direction of capacitor up to 10N and keep it for 10±1 s.</p> <p>With the termination in its normal position, the capacitor is held by its body in such a manner that the axis of the termination is vertical; a mass applying a force of 5N is then suspended from the end of the termination.</p> <p>The body of the capacitor is then inclined, within a period of 2 to 3 s, through an angle of approximately 90° in the vertical plane and then returned to its initial position over the same period of time; this operation constitutes one bend. One bend immediately followed by a second bend in the opposite direction.</p>
		Bending	
10	Vibration resistance	Appearance	<p>The capacitor should be firmly soldered to the supporting lead wire and vibration which is 10 to 55Hz in the vibration frequency range, 1.5mm in total amplitude, and about 1min in the rate of vibration change from 10Hz to 55Hz and back to 10Hz is applied for a total of 6 h; 2 h each in 3 mutually perpendicular directions.</p>
		Capacitance	
		D.F.	
11	Solderability of leads	Lead wire should be soldered With uniformly coated on the axial direction over 3/4 of the circumferential direction.	<p>The lead wire of a capacitor should be dipped into a ethanol solution of 25wt% rosin and then into molten solder for 2±0.5 s. In both cases the depth of dipping is up to about 1.5 to 2.0mm from the root of lead wires.</p> <p>Temp. of solder : 245±5°C Lead Free Solder (Sn-3Ag-0.5Cu)</p>
12	Soldering effect (Non-preheat)	Appearance	<p>Solder temperature: 350±10°C or 260±5°C Immersion time : 3.5±0.5 s (In case of 260±5°C : 10±1 s)</p> <p>The depth of immersion is up to about 1.5 to 2.0mm from the root of lead wires.</p> <div style="text-align: center;">  </div> <p>Pre-treatment : Capacitor should be stored at 125±2°C for 1 h, and apply the AC4000V(r.m.s.) 60s then placed at *1room condition for 24±2 h before initial measurements. (Do not apply to Char. SL)</p> <p>Post-treatment : Capacitor should be stored for 1 to 2 h at *1room condition.</p>
		Capacitance change	
		I.R.	
		Dielectric strength	
13	Soldering effect (On-preheat)	Appearance	<p>First the capacitor should be stored at 120+0/-5°C for 60+0/-5 s.</p> <p>Then, as in figure, the lead wires should be immersed solder of 260+0/-5°C up to 1.5 to 2.0mm from the root of terminal for 7.5+0/-1 s.</p> <div style="text-align: center;">  </div> <p>Pre-treatment : Capacitor should be stored at 125±2°C for 1 h, and apply the AC4000V(r.m.s.) 60s then placed at *1room condition for 24±2 h before initial measurements. (Do not apply to Char. SL)</p> <p>Post-treatment : Capacitor should be stored for 1 to 2 h at *1room condition.</p>
		Capacitance change	
		I.R.	
		Dielectric strength	

*1 "room condition" Temperature: 15 to 35°C, Relative humidity: 45 to 75%, Atmospheric pressure: 86 to 106kPa

Reference only

No.	Item	Specification	Test method										
14	Flame test	<p>The capacitor flame discontinue as follows.</p> <table border="1" style="margin-left: auto; margin-right: auto;"> <thead> <tr> <th>Cycle</th> <th>Time</th> </tr> </thead> <tbody> <tr> <td>1 to 4</td> <td>30 s max.</td> </tr> <tr> <td>5</td> <td>60 s max.</td> </tr> </tbody> </table>	Cycle	Time	1 to 4	30 s max.	5	60 s max.	<p>The capacitor should be subjected to applied flame for 15 s. and then removed for 15 s until 5 cycle.</p> 				
Cycle	Time												
1 to 4	30 s max.												
5	60 s max.												
15	Passive flammability	<p>The burning time should not be exceeded the time 30 s. The tissue paper should not ignite.</p>	<p>The capacitor under test should be held in the flame in the position which best promotes burning. Time of exposure to flame is for 30 s.</p> <p>Length of flame : 12±1mm Gas burner : Length 35mm min. Inside Dia. 0.5±0.1mm Outside Dia. 0.9mm max. Gas : Butane gas Purity 95% min.</p> 										
16	Humidity (Under steady state)	<table border="1" style="width: 100%;"> <tr> <td style="width: 20%;">Appearance</td> <td>No marked defect.</td> </tr> <tr> <td>Capacitance change</td> <td>Char. SL : Within ±5% Char. B : Within ±10% Char. E : Within ±15%</td> </tr> <tr> <td>D.F.</td> <td>Char. SL : 2.5% max. Char. B, E : 5.0% max.</td> </tr> <tr> <td>I.R.</td> <td>3000MΩ min.</td> </tr> <tr> <td>Dielectric strength</td> <td>Per item 3</td> </tr> </table>	Appearance	No marked defect.	Capacitance change	Char. SL : Within ±5% Char. B : Within ±10% Char. E : Within ±15%	D.F.	Char. SL : 2.5% max. Char. B, E : 5.0% max.	I.R.	3000MΩ min.	Dielectric strength	Per item 3	<p>Set the capacitor for 500±12 h at 40±2°C in 90 to 95% relative humidity.</p> <p>Pre-treatment : Capacitor should be stored at 125±2°C for 1 h, and apply the AC4000V(r.m.s.) 60s then placed at *1room condition for 24±2 h before initial measurements. (Do not apply to Char. SL)</p> <p>Post-treatment : Capacitor should be stored for 1 to 2 h at *1room condition.</p>
Appearance	No marked defect.												
Capacitance change	Char. SL : Within ±5% Char. B : Within ±10% Char. E : Within ±15%												
D.F.	Char. SL : 2.5% max. Char. B, E : 5.0% max.												
I.R.	3000MΩ min.												
Dielectric strength	Per item 3												
17	Humidity loading	<table border="1" style="width: 100%;"> <tr> <td style="width: 20%;">Appearance</td> <td>No marked defect.</td> </tr> <tr> <td>Capacitance change</td> <td>Char. SL : Within ±5% Char. B : Within ±10% Char. E : Within ±15%</td> </tr> <tr> <td>D.F.</td> <td>Char. SL : 2.5% max. Char. B, E : 5.0% max.</td> </tr> <tr> <td>I.R.</td> <td>3000MΩ min.</td> </tr> <tr> <td>Dielectric strength</td> <td>Per item 3</td> </tr> </table>	Appearance	No marked defect.	Capacitance change	Char. SL : Within ±5% Char. B : Within ±10% Char. E : Within ±15%	D.F.	Char. SL : 2.5% max. Char. B, E : 5.0% max.	I.R.	3000MΩ min.	Dielectric strength	Per item 3	<p>Apply AC760V(r.m.s.) for 500±12 h at 40±2°C in 90 to 95% relative humidity.</p> <p>Pre-treatment : Capacitor should be stored at 125±2°C for 1 h, and apply the AC4000V(r.m.s.) 60s then placed at *1room condition for 24±2 h before initial measurements. (Do not apply to Char. SL)</p> <p>Post-treatment : Capacitor should be stored for 1 to 2 h at *1room condition.</p>
Appearance	No marked defect.												
Capacitance change	Char. SL : Within ±5% Char. B : Within ±10% Char. E : Within ±15%												
D.F.	Char. SL : 2.5% max. Char. B, E : 5.0% max.												
I.R.	3000MΩ min.												
Dielectric strength	Per item 3												
<p>*1 "room condition" Temperature: 15 to 35°C, Relative humidity: 45 to 75%, Atmospheric pressure: 86 to 106kPa</p>													

Reference only

No.	Item	Specification	Test method																										
18	Life	Appearance	No marked defect.																										
		Capacitance change	Within $\pm 20\%$																										
		I.R.	3000M Ω min.																										
		Dielectric strength	Per item 3																										
				<p>Impulse voltage</p> <p>Each individual capacitor should be subjected to a 12kV impulses for three times. Then the capacitors are applied to life test.</p> <div style="text-align: center;"> </div> <p>The capacitors are placed in a circulating air oven for a period of 1 000 h.</p> <p>The air in the oven is maintained at a temperature of $125 \pm 2 / -0$ °C, and relative humidity of 50% max.. Throughout the test, the capacitors are subjected to a AC950V(r.m.s.) <50/60Hz> alternating voltage of mains frequency, except that once each hour the voltage is increased to AC1 000V(r.m.s.) for 0.1 s.</p> <p>Pre-treatment : Capacitor should be stored at 125 ± 2°C for 1 h, and apply the AC4000V(r.m.s.) 60s then placed at *1room condition for 24 ± 2 h before initial measurements. (Do not apply to Char. SL)</p> <p>Post-treatment : Capacitor should be stored for 24 ± 2 h at *1room condition.</p>																									
19	Temperature and immersion cycle	Appearance	No marked defect.																										
		Capacitance change	Char. SL : Within $\pm 5\%$ Char. B : Within $\pm 10\%$ Char. E : Within $\pm 20\%$																										
		D.F.	Char. SL : 2.5% max. Char. B, E : 5.0% max.																										
		I.R.	3000M Ω min.																										
		Dielectric strength	Per item 3																										
		<p>The capacitor should be subjected to 500 temperature cycles, then consecutively to 2 immersion cycles.</p> <p><Temperature cycle></p> <table border="1" style="margin-left: auto; margin-right: auto;"> <thead> <tr> <th>Step</th> <th>Temperature(°C)</th> <th>Time</th> </tr> </thead> <tbody> <tr> <td>1</td> <td>-40+0/-3</td> <td>30 min</td> </tr> <tr> <td>2</td> <td>Room temp.</td> <td>3 min</td> </tr> <tr> <td>3</td> <td>+125+3/-0</td> <td>30 min</td> </tr> <tr> <td>4</td> <td>Room temp.</td> <td>3 min</td> </tr> </tbody> </table> <p style="text-align: right;">Cycle time:500 cycles</p> <p><Immersion cycle></p> <table border="1" style="margin-left: auto; margin-right: auto;"> <thead> <tr> <th>Step</th> <th>Temperature(°C)</th> <th>Time</th> <th>Immersion water</th> </tr> </thead> <tbody> <tr> <td>1</td> <td>+65+5/-0</td> <td>15 min</td> <td>Clean water</td> </tr> <tr> <td>2</td> <td>0\pm3</td> <td>15 min</td> <td>Salt water</td> </tr> </tbody> </table> <p style="text-align: right;">Cycle time:2 cycles</p> <p>Pre-treatment : Capacitor should be stored at 125 ± 2°C for 1 h, and apply the AC4000V(r.m.s.) 60s then placed at *1room condition for 24 ± 2 h before initial measurements. (Do not apply to Char. SL)</p> <p>Post-treatment : Capacitor should be stored for 24 ± 2 h at *1room condition.</p>	Step	Temperature(°C)	Time	1	-40+0/-3	30 min	2	Room temp.	3 min	3	+125+3/-0	30 min	4	Room temp.	3 min	Step	Temperature(°C)	Time	Immersion water	1	+65+5/-0	15 min	Clean water	2	0 \pm 3	15 min	Salt water
Step	Temperature(°C)	Time																											
1	-40+0/-3	30 min																											
2	Room temp.	3 min																											
3	+125+3/-0	30 min																											
4	Room temp.	3 min																											
Step	Temperature(°C)	Time	Immersion water																										
1	+65+5/-0	15 min	Clean water																										
2	0 \pm 3	15 min	Salt water																										
<p>*1 "room condition" Temperature: 15 to 35°C, Relative humidity: 45 to 75%, Atmospheric pressure: 86 to 106kPa</p>																													

Reference only

6.Packing specification

- Bulk type (Packing style code : B)

The number of packing = $\frac{\text{Packing quantity}}{\text{Packing quantity}} \times n$

The size of packing case and packing way

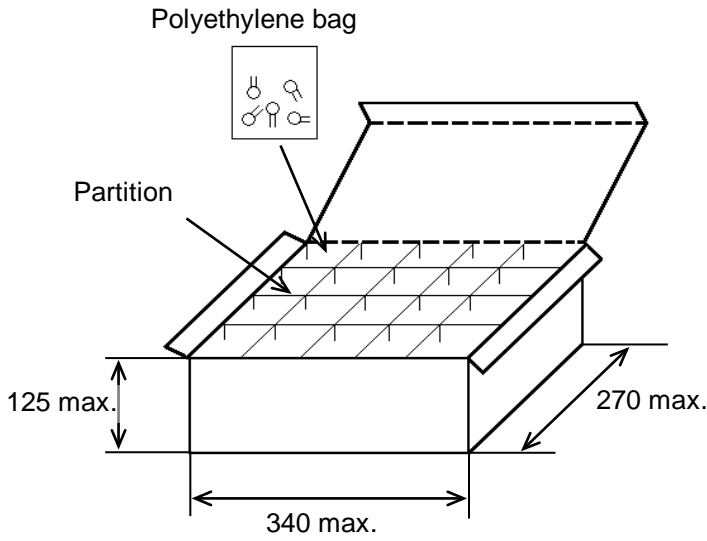

- *1 : Please refer to [Part number list].
- *2 : Standard n = 20 (bag)

Note)
The outer package and the number of outer packing be changed by the order getting amount.

Unit : mm

- Ammo pack taping type (Packing style code : A)

- The tape with capacitors is packed zigzag into a case.
- When body of the capacitor is piled on other body under it.
- There should be 3 pitches and over without capacitors in leader and trailer.

The size of packing case and packing way

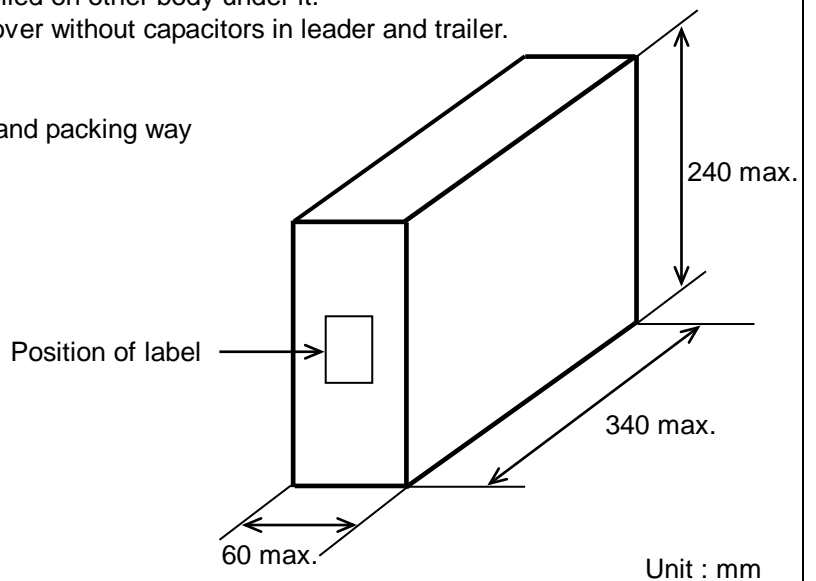

Unit : mm

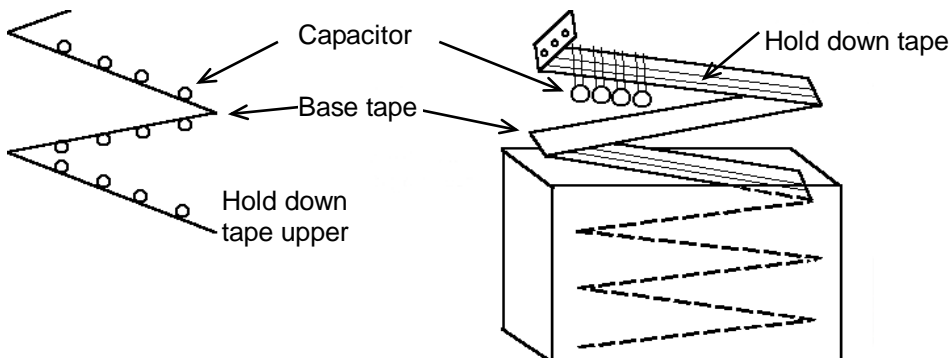

Reference only

7. Taping specification

7-1. Dimension of capacitors on tape

Vertical crimp taping type < Lead code : N4 >

Pitch of component 25.4mm / Lead spacing 10.0mm



Unit : mm

Item	Code	Dimensions	Remarks
Pitch of component	P	25.4±2.0	
Pitch of sprocket hole	P0	12.7±0.3	
Lead spacing	F	10.0±1.0	
Length from hole center to lead	P1	7.7±1.5	
Body diameter	D	Please refer to [Part number list].	
Deviation along tape, left or right	ΔS	0±2.0	They include deviation by lead bend .
Carrier tape width	W	18.0±0.5	
Position of sprocket hole	W1	9.0±0.5	Deviation of tape width direction
Lead distance between reference and bottom planes	H0	18.0 $\pm_{0}^{2.0}$	
Protrusion length	Q	+0.5~-1.0	
Diameter of sprocket hole	φD0	4.0±0.1	
Lead diameter	φd	0.60±0.05	
Total tape thickness	t1	0.6±0.3	They include hold down tape thickness.
Total thickness, tape and lead wire	t2	1.5 max.	
Deviation across tape, front	Δh1	2.0 max.	
Deviation across tape, rear	Δh2		
Portion to cut in case of defect	L	11.0 $\pm_{1.0}^0$	
Hold down tape width	W0	11.5 min.	
Hold down tape position	W2	1.5±1.5	
Coating extension on lead	e	Up to the end of crimp	
Body thickness	T	Please refer to [Part number list].	

Reference only

7-2. Splicing way of tape

- 1) Adhesive force of tape is over 3N at test condition as below.

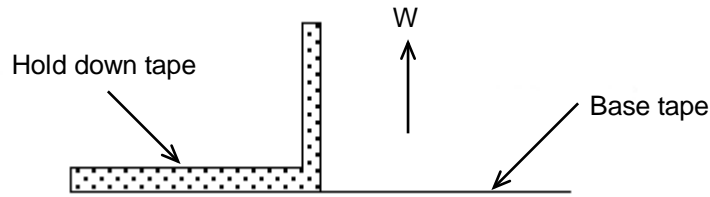

2) Splicing of tape

- a) When base tape is spliced

- Base tape should be spliced by cellophane tape.
(Total tape thickness should be less than 1.05mm.)

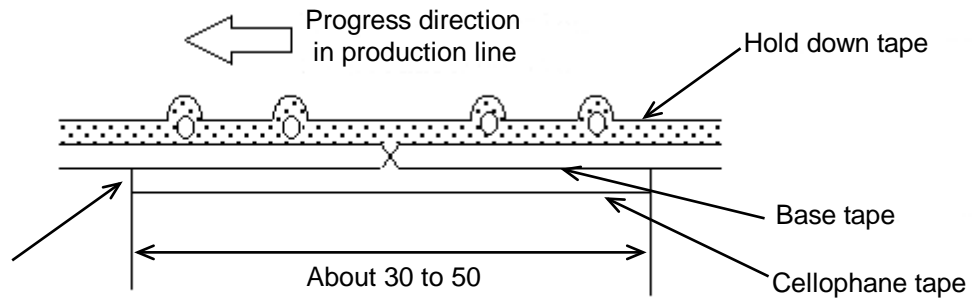

No lifting for the direction of progressing

Unit : mm

- b) When hold down tape is spliced

- Hold down tape should be spliced with overlapping.
(Total tape thickness should be less than 1.05mm.)

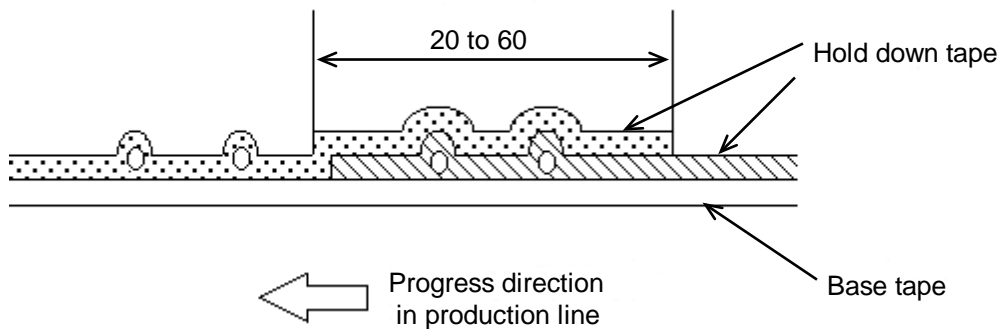

Unit : mm

- c) When both tape are spliced

- Base tape and hold down tape should be spliced with splicing tape.

3) Missing components

- There should be no consecutive missing of more than three components.
- The number of missing components should be not more than 0.5% of total components that should be present in a Ammo pack.

EU RoHS and Halogen Free

This products of the following crresponds to EU RoHS and Halogen Free

(1) RoHS

EU RoHS 2011/65/EC compliance

maximum concentration values tolerated by weight in homogeneous materials

- 1000 ppm maximum Lead
- 1000 ppm maximum Mercury
- 100 ppm maximum Cadmium
- 1000 ppm maximum Hexavalent chromium
- 1000 ppm maximum Polybrominated biphenyls (PBB)
- 1000 ppm maximum Polybrominated diphenyl ethers (PBDE)

(2) Halogen-Free

The International Electrochemical Commission's (IEC) Definition of Halogen-Free (IEC 61249-2-21) compliance

- 900 ppm maximum chlorine
- 900 ppm maximum bromine
- 1500 ppm maximum total chlorine and bromine



Компания «ЭлектроПласт» предлагает заключение долгосрочных отношений при поставках импортных электронных компонентов на взаимовыгодных условиях!

Наши преимущества:

- Оперативные поставки широкого спектра электронных компонентов отечественного и импортного производства напрямую от производителей и с крупнейших мировых складов;
- Поставка более 17-ти миллионов наименований электронных компонентов;
- Поставка сложных, дефицитных, либо снятых с производства позиций;
- Оперативные сроки поставки под заказ (от 5 рабочих дней);
- Экспресс доставка в любую точку России;
- Техническая поддержка проекта, помощь в подборе аналогов, поставка прототипов;
- Система менеджмента качества сертифицирована по Международному стандарту ISO 9001;
- Лицензия ФСБ на осуществление работ с использованием сведений, составляющих государственную тайну;
- Поставка специализированных компонентов (Xilinx, Altera, Analog Devices, Intersil, Interpoint, Microsemi, Aeroflex, Peregrine, Syfer, Eurofarad, Texas Instrument, Miteq, Cobham, E2V, MA-COM, Hittite, Mini-Circuits, General Dynamics и др.);

Помимо этого, одним из направлений компании «ЭлектроПласт» является направление «Источники питания». Мы предлагаем Вам помощь Конструкторского отдела:

- Подбор оптимального решения, техническое обоснование при выборе компонента;
- Подбор аналогов;
- Консультации по применению компонента;
- Поставка образцов и прототипов;
- Техническая поддержка проекта;
- Защита от снятия компонента с производства.



Как с нами связаться

Телефон: 8 (812) 309 58 32 (многоканальный)

Факс: 8 (812) 320-02-42

Электронная почта: org@eplast1.ru

Адрес: 198099, г. Санкт-Петербург, ул. Калинина, дом 2, корпус 4, литера А.