

GaAs pHEMT LOW NOISE AMPLIFIER 0.3 - 3.0 GHz



Typical Applications

The HMC374SC70E is ideal for:

- Cellular/PCS/3G
- WCS, MMDS & ISM
- Fixed Wireless & WLAN
- Private Land Mobile Radio

Features

- Single Supply: $V_{dd} = +3.0$ to $+3.6V$
- Broadband Performance
- Low Noise Figure: 1.6 dB
- High Output IP3: +35 dBm
- High Gain: 15 dB @ 0.6 GHz

Functional Diagram

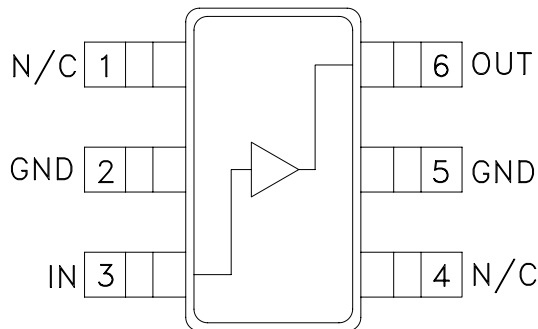

General Description

The HMC374SC70E is a general purpose broadband Low Noise Amplifier (LNA) for use in the 0.3 - 3 GHz frequency range. The LNA provides 15 dB of gain and a 1.6 dB noise figure from a single positive supply of +3.0 to +3.6V. The low noise figure coupled with a high P1dB (17 dBm) and high OIP3 (35 dBm) make this part ideal for cellular applications. The compact LNA is designed for repeatable gain and noise figure performance. To minimize board area the design is offered in a low cost SC70E package that occupies only 0.089" x 0.053".

Electrical Specifications, $V_{dd} = +3.3V$

Parameter	Min. [2]	Typ. [1]	Max. [2]	Min. [2]	Typ. [1]	Max. [2]	Min. [2]	Typ. [1]	Max. [2]	Units
Frequency		0.6			1.0			3.0		GHz
Gain	14	15		13	14.5		6	8.5		dB
Gain Variation Over Temperature (-40°C to +25°C)		0.005			0.008			0.012		dB/°C
Gain Variation Over Temperature (+25°C to +85°C)		0.004			0.005			0.008		
Noise Figure		2	2.6		1.6	2.3		1.8	2.2	dB
Input Return Loss	4.5	5.5		6	7.5		8	9		
Output Return Loss	5.5	7.5		8	10		13	15		
Output 1 dB Compression (P1dB)	15.5	16.5		16	17		16.5	18		dBm
Saturated Output Power (Psat)	17.5	18.5		17.5	18.5		18	19		
Output Third Order Intercept (OIP3)		34			33.5			36		
Supply Current (I _{dd}) (V _{dd} = +3.3V)		75			75			75		mA
Supply Voltage (V _{dd})	3.0	3.3	3.6	3.0	3.3	3.6	3.0	3.3	3.6	V

[1] Typical values are determined at $T_A = +25^\circ C$

[2] Minimum and maximum values are determined from $T_A = -40^\circ C$ to $T_A = +85^\circ C$



**GaAs pHEMT LOW NOISE AMPLIFIER
0.3 - 3.0 GHz**

Broadband Gain & Return Loss

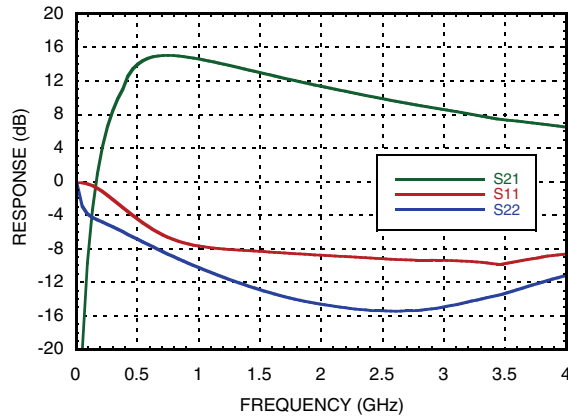

Gain vs. Temperature

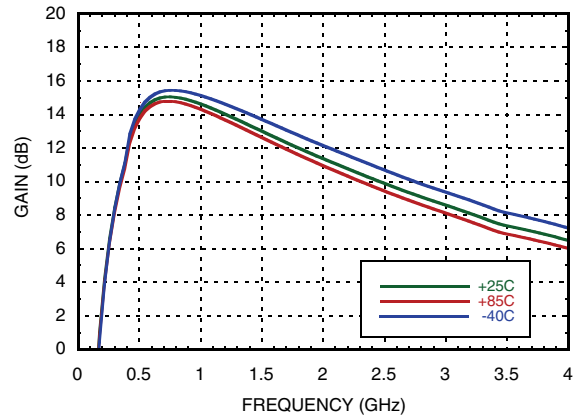

Input Return Loss vs. Temperature

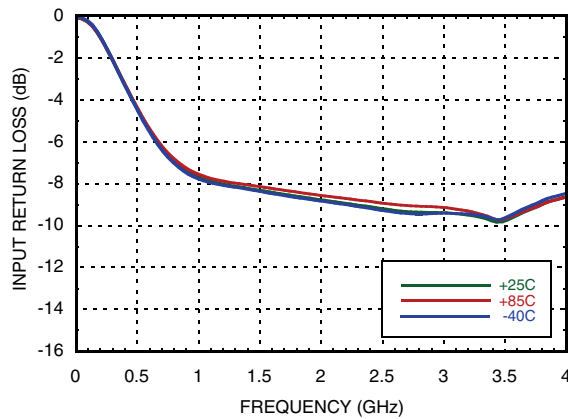

Output Return Loss vs. Temperature

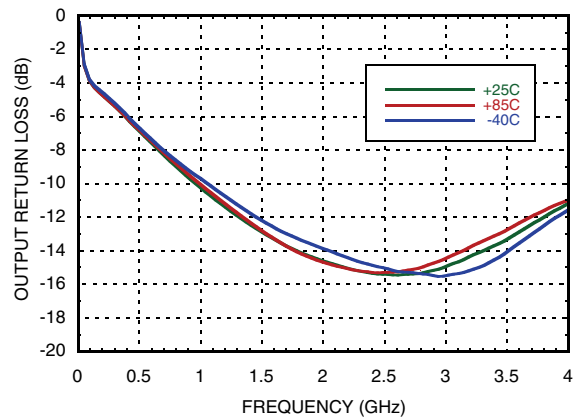

Noise Figure vs. Temperature

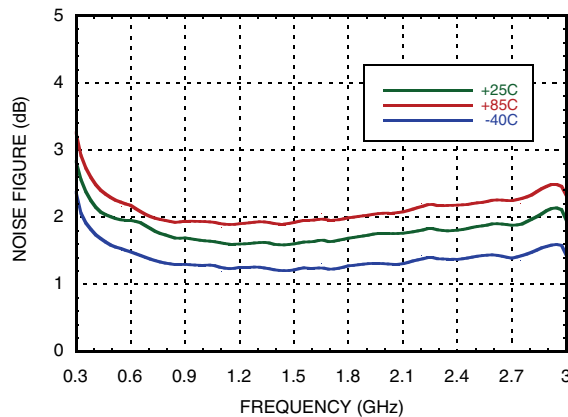

Output IP3 vs. Temperature [1]

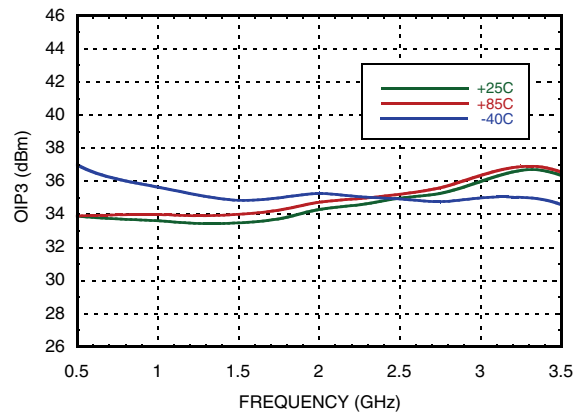

[1] OIP3 measurements were taken for Pout = 0 dBm



GaAs pHEMT LOW NOISE AMPLIFIER
0.3 - 3.0 GHz

AMPLIFIERS - SMT

Output P1dB vs. Temperature

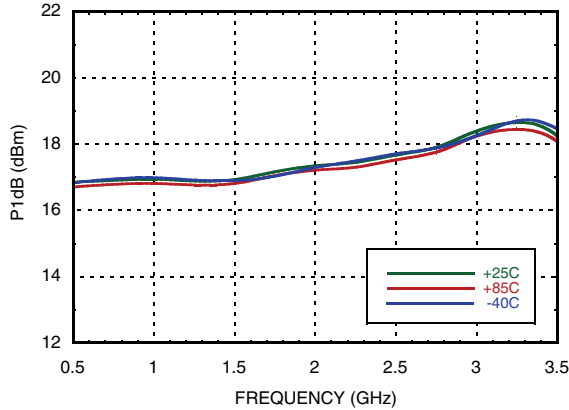

Output Psat vs. Temperature

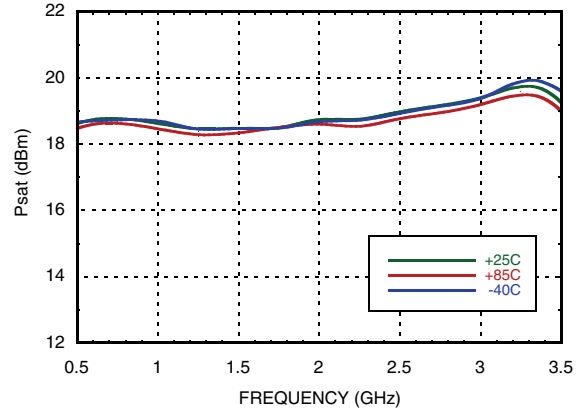

Reverse Isolation vs. Temperature

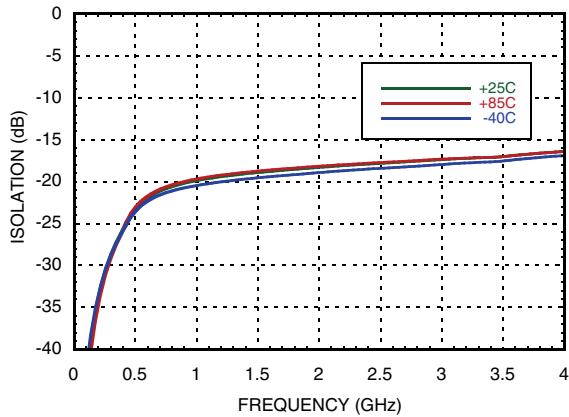

Pout, Gain & PAE @ 2 GHz

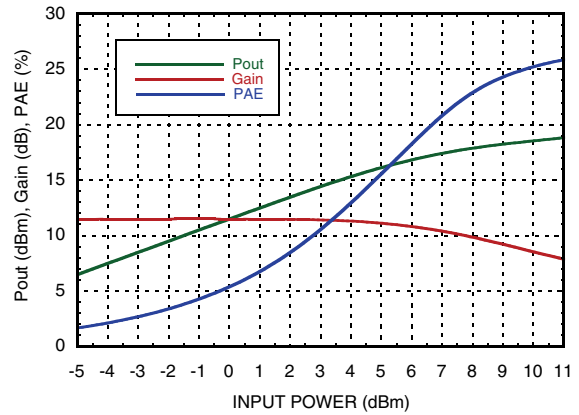

Gain, Noise Figure & P1dB vs. Supply Voltage @ 2 GHz

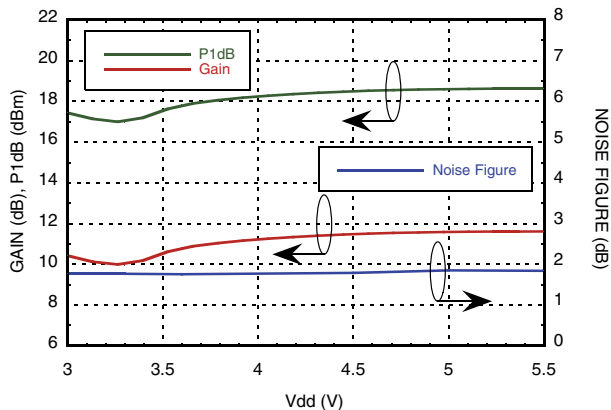

Supply Current vs. Input Power @ 2 GHz

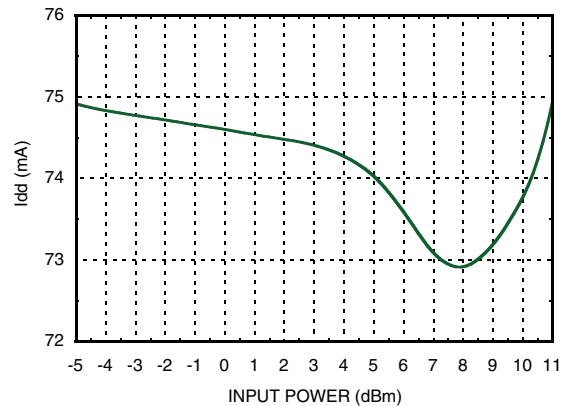

Information furnished by Analog Devices is believed to be accurate and reliable. However, no responsibility is assumed by Analog Devices for its use, nor for any infringements of patents or other rights of third parties that may result from its use. Specifications subject to change without notice. No license is granted by implication or otherwise under any patent or patent rights of Analog Devices. Trademarks and registered trademarks are the property of their respective owners.

For price, delivery, and to place orders: Analog Devices, Inc., One Technology Way, P.O. Box 9106, Norwood, MA 02062-9106 Phone: 781-329-4700 • Order online at www.analog.com Application Support: Phone: 1-800-ANALOG-D



GaAs pHEMT LOW NOISE AMPLIFIER 0.3 - 3.0 GHz

Absolute Maximum Ratings

Drain Bias Voltage (Vdd)	+7.0 Vdc
RF Input Power (RFIN)(Vdd = +5.0 Vdc)	15 dBm
Channel Temperature	150 °C
Continuous P _{diss} (T = 85 °C) (derate 4.88 mW/°C above 85 °C)	0.32 W
Thermal Resistance (channel to lead)	205 °C/W
Storage Temperature	-65 to +150 °C
Operating Temperature	-40 to +85 °C
ESD Sensitivity (HBM)	Class 0

Typical Supply Current vs. Vdd

Vdd (V)	I _{dd} (mA)
3	75
3.3	75
3.6	75



ELECTROSTATIC SENSITIVE DEVICE
OBSERVE HANDLING PRECAUTIONS

Outline Drawing

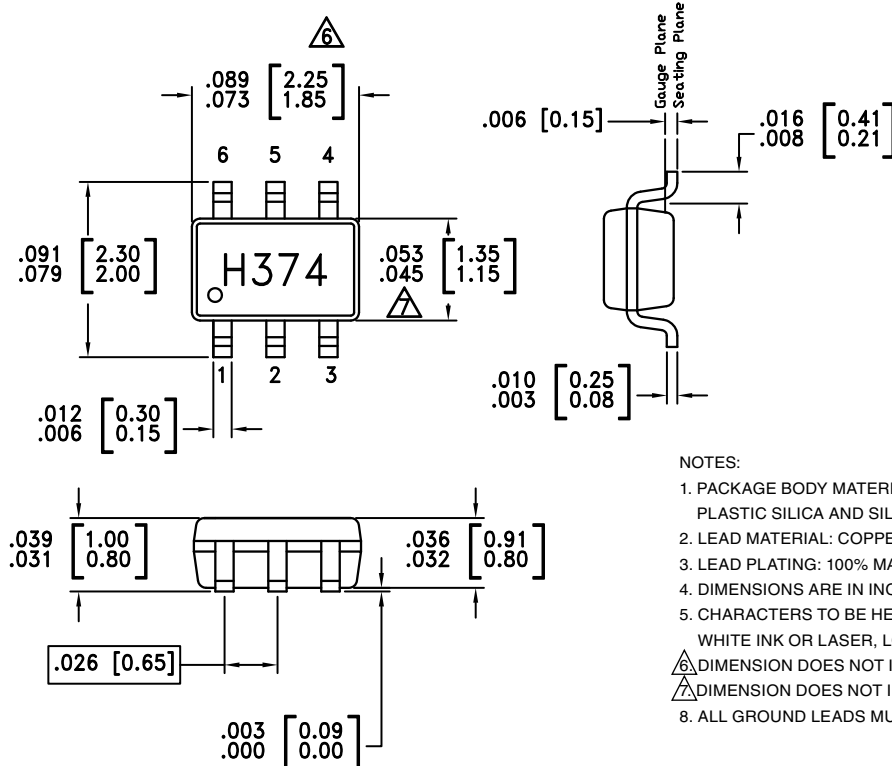

Package Information

Part Number	Package Body Material	Lead Finish	MSL Rating	Package Marking ^[3]
HMC374SC70E	RoHS-compliant Low Stress Injection Molded Plastic	100% matte Sn	MSL1 ^[2]	H374E XXXX

[1] Max peak reflow temperature of 235 °C

[2] Max peak reflow temperature of 260 °C

[3] 4-Digit lot number XXXX



**GaAs pHEMT LOW NOISE AMPLIFIER
0.3 - 3.0 GHz**

Pin Descriptions

Pin Number	Function	Description	Interface Schematic
1,4	N/C	These pins may be connected to RF/DC ground. Performance will not be affected.	
2, 5	GND	These pins must be connected to RF/DC ground.	
3	IN	RF input pin is DC coupled. An off-chip DC blocking capacitor is required.	
6	OUT	RF output and DC Bias for the output stage. See application circuit for off-chip components.	

Application Circuit

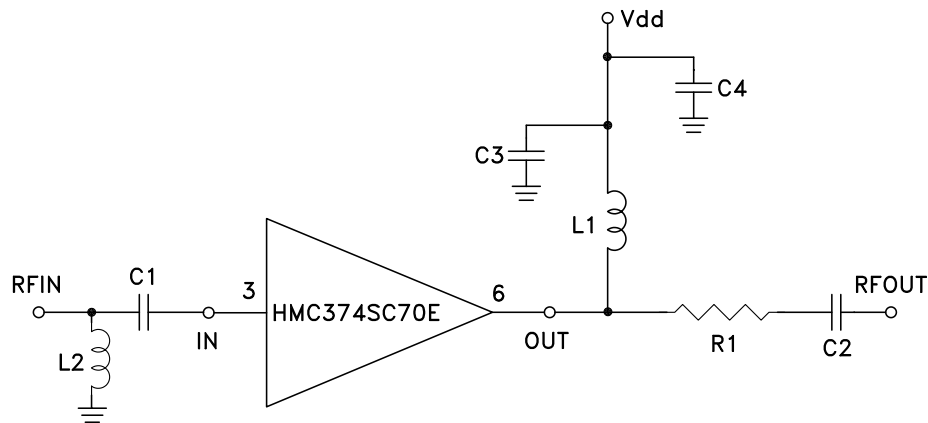

Information furnished by Analog Devices is believed to be accurate and reliable. However, no responsibility is assumed by Analog Devices for its use, nor for any infringements of patents or other rights of third parties that may result from its use. Specifications subject to change without notice. No license is granted by implication or otherwise under any patent or patent rights of Analog Devices. Trademarks and registered trademarks are the property of their respective owners.

For price, delivery, and to place orders: Analog Devices, Inc., One Technology Way, P.O. Box 9106, Norwood, MA 02062-9106 Phone: 781-329-4700 • Order online at www.analog.com Application Support: Phone: 1-800-ANALOG-D



**GaAs pHEMT LOW NOISE AMPLIFIER
0.3 - 3.0 GHz**

Evaluation PCB

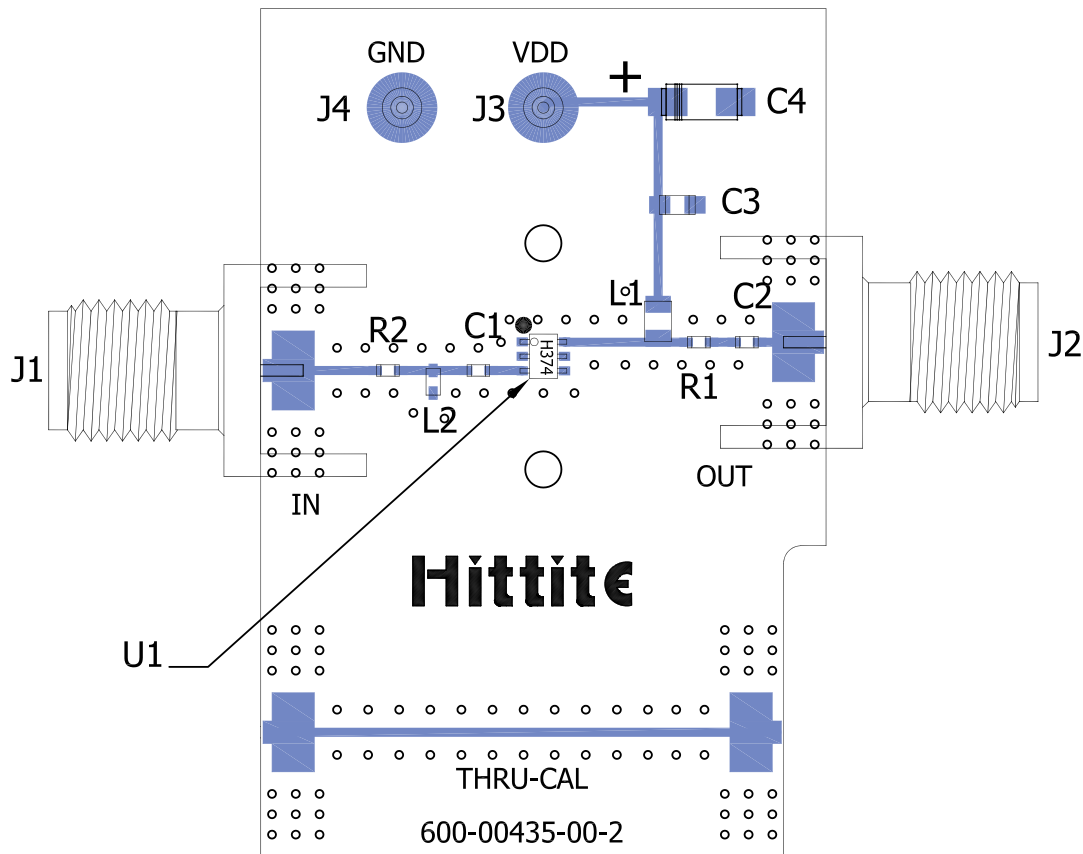

List of Materials for EVAL01-HMC374SC70E [1]

Item	Description
J1, J2	PCB Mount SMA Connector
J3, J4	DC Pin
C1	27 pF Capacitor, 0402 Pkg.
C2	150 pF Capacitor, 0402 Pkg.
C3	10 nF Capacitor, 0603 Pkg.
C4	4.7 Capacitor, Tantalum
L1	27 nH Inductor, 0603 Pkg.
L2	22 nH Inductor, 0402 Pkg.
R1	10 Ohms Resistor, 0402 Pkg.
R2	0 Ohm Resistor, 0402 Pkg.
U1	HMC374SC70E Amplifier
PCB [2]	600-00435-00 Evaluation PCB

[1] Reference this number when ordering complete evaluation PCB

[2] Circuit Board Material: Roger 4350

The circuit board used in the application should use RF circuit design techniques. Signal lines should have 50 Ohm impedance while the package ground leads should be connected directly to the ground plane similar to that shown above. A sufficient number of via holes should be used to connect the top and bottom ground planes. The evaluation circuit board shown is available from Hittite upon request.



Компания «ЭлектроПласт» предлагает заключение долгосрочных отношений при поставках импортных электронных компонентов на взаимовыгодных условиях!

Наши преимущества:

- Оперативные поставки широкого спектра электронных компонентов отечественного и импортного производства напрямую от производителей и с крупнейших мировых складов;
- Поставка более 17-ти миллионов наименований электронных компонентов;
- Поставка сложных, дефицитных, либо снятых с производства позиций;
- Оперативные сроки поставки под заказ (от 5 рабочих дней);
- Экспресс доставка в любую точку России;
- Техническая поддержка проекта, помощь в подборе аналогов, поставка прототипов;
- Система менеджмента качества сертифицирована по Международному стандарту ISO 9001;
- Лицензия ФСБ на осуществление работ с использованием сведений, составляющих государственную тайну;
- Поставка специализированных компонентов (Xilinx, Altera, Analog Devices, Intersil, Interpoint, Microsemi, Aeroflex, Peregrine, Syfer, Eurofarad, Texas Instrument, Miteq, Cobham, E2V, MA-COM, Hittite, Mini-Circuits, General Dynamics и др.);

Помимо этого, одним из направлений компании «ЭлектроПласт» является направление «Источники питания». Мы предлагаем Вам помощь Конструкторского отдела:

- Подбор оптимального решения, техническое обоснование при выборе компонента;
- Подбор аналогов;
- Консультации по применению компонента;
- Поставка образцов и прототипов;
- Техническая поддержка проекта;
- Защита от снятия компонента с производства.



Как с нами связаться

Телефон: 8 (812) 309 58 32 (многоканальный)

Факс: 8 (812) 320-02-42

Электронная почта: org@eplast1.ru

Адрес: 198099, г. Санкт-Петербург, ул. Калинина, дом 2, корпус 4, литера А.