

This document is the property of Amphenol Corporation and is delivered on the express condition that it not be disclosed, reproduced or used, in whole or in part, for manufacture or sale by anyone other than Amphenol Corporation without its prior consent, and that no right is granted to disclose or to use any information in this document.

The marking on this product doesn't contain environmental hazardous materials per Material Specification 55-00259 for Sony GP compliant or per directive 2011/65/EU for RoHS compliant.

ORIGINAL

REVISIONS				
SYM	ECN No.	DESCRIPTION	DATE	APPROVED
A	NE-14096	RELEASE TO PRODUCTION	05/21/2014	Arron Lin
B	NE-15016	COMBINE DRAWING FOR PACKAGE AND TAIL OPTIONS.	02/02/2015	Arron Lin
C	NE-16117	ADDED METAL BOARDLOCK OPTION	05/13/2016	Roger Tsai



NOTES:

- MATERIAL:
 - HOUSING: HIGH TEMPERATURE THERMAL PLASTIC, LCP, UL94V-0, COLOR: BLACK.
 - TERMINAL: HIGH PERFORMANCE COPPER ALLOY.
 - METAL BOARDLOCK: COPPER ALLOY.
- FINISH:
 - TERMINAL:
 - CONTACT AREA: SELECTIVE PLATING;
 - SOLDERING AREA: MATTE TIN PLATING 100 μ" THICKNESS MIN.;
 - UNDER PLATING: NICKEL PLATING 50 μ" THICKNESS MIN. OVERALL.
 - METAL BOARDLOCK:
 - MATTE TIN PLATING 100 μ" THICKNESS MIN.;
 - UNDER PLATING: NICKEL PLATING 50 μ" THICKNESS MIN. OVERALL.
- PACKING IS PER AMTA PACKING SPECIFICATION PKS-0001.
- THIS PRODUCT DOESN'T CONTAIN ENVIRONMENTAL HAZARDOUS PER DIRECTIVE 2011/65/EU FOR RoHS COMPLIANT.
- PRODUCT SPECIFICATION REFER TO : PS-7528
- TO ENSURE CURRENT RATING CAPABILITY, PLEASE ADOPT TOTAL SOLUTION. (G88MPH CABLE HOUSING SERIES WITH G88MPC CABLE TERMINAL SERIES)



PART NO. G88MPBXXOX2XXEU

No. OF CIRCUIT

- DIM A /PACKING OPTIONS/METAL BOARDLOCK
- C1: 2.10mm/TRAY/ W/O METAL BOARDLOCK
 - C : 3.20mm/TRAY/ W/O METAL BOARDLOCK
 - C3: 2.10mm/TRAY/ W/METAL BOARDLOCK
 - C4: 3.20mm/TRAY/ W/METAL BOARDLOCK
 - 1R: 2.10mm/T&R/ W/O METAL BOARDLOCK
 - 2R: 3.20mm/T&R/ W/O METAL BOARDLOCK
 - 3R: 2.10mm/T&R/ W/METAL BOARDLOCK
 - 4R: 3.20mm/T&R/ W/METAL BOARDLOCK

CONTACT FINISH

- 0: MATTE TIN (OVERALL)
- UNDER PLATING NICKEL
- 50 μ" THICKNESS MIN
- 1: FLASH GOLD (OVERALL)
- 2: 15 μ" GOLD
- 3: 30 μ" GOLD

28.70	33.0	39.65	12
25.70	30.0	36.65	11
22.70	27.0	33.65	10
19.70	24.0	30.65	09
16.70	21.0	27.65	08
13.70	18.0	24.65	07
10.70	15.0	21.65	06
7.70	12.0	18.65	05
4.70	9.0	15.65	04
NA	6.0	12.65	03
NA	3.0	9.65	02
C	A	B	POS.



PCB LAYOUT: COMPONENT SIDE
RECOMMENDED PCB THICKNESS: 1.57
4-12 CIRCUIT HEADERS

TOLERANCE	APPROVALS	DATE	TITLE
X. ±0.30	DRAWN Aqua Chou	05/13/2016	G88MP SERIES MICRO POWER PLUS 3.0 PITCH S/R R/A DIP TYPE
X.X ±0.20	CHECKED Roger Tsai	05/13/2016	
X.XXX ±0.10	APPROVED Roger Tsai	05/13/2016	
ANGULAR ±1°	DWG TYPE CUST DWG	PROJECT CODE PHD	
UNLESS OTHERWISE SPECIFIED			

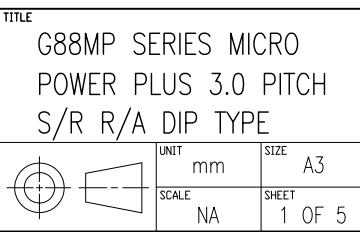

Amphenol®
Amphenol Corporation
Amphenol Taiwan Corporation

PART No. G88MPBXXOX2XXEU
DWG No. G88MPBXXOX2XXEU REV. C

This document is the property of Amphenol Corporation and is delivered on the express condition that is not to be disclosed, reproduced or used, in whole or in part, for manufacture or sale by anyone other than Amphenol Corporation without its prior consent, and that no right is granted to disclose or to use any information in this document.

The marking on this product doesn't contain environmental hazardous materials per Material Specification SS-00259 for Sony GP compliant or per directive 2011/65/EU for RoHS compliant.



ORIGINAL



REVISIONS				
SYM	ECN No.	DESCRIPTION	DATE	APPROVED
A	NE-14096	RELEASE TO PRODUCTION	05/21/2014	Arron Lin
B	NE-15016	COMBINE DRAWING FOR PACKAGE AND TAIL OPTIONS.	02/02/2015	Arron Lin
C	NE-16117	ADDED METAL BOARDLOCK OPTION	05/13/2016	Roger Tsai



2 POS

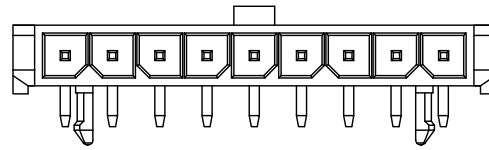

9 POS

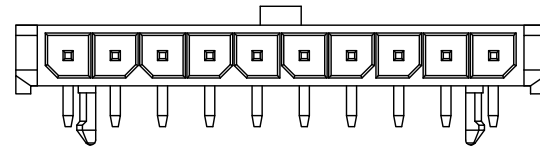

10 POS

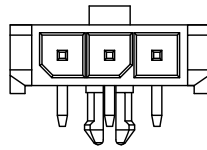

3 POS

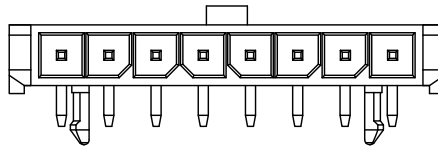

8 POS

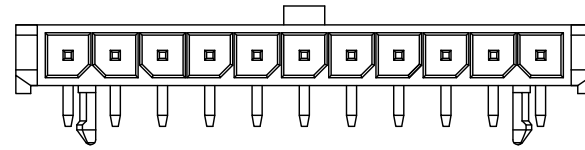

11 POS

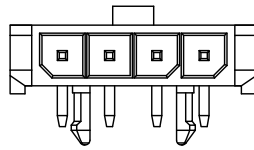

4 POS

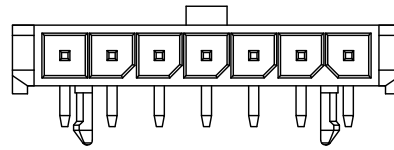

7 POS

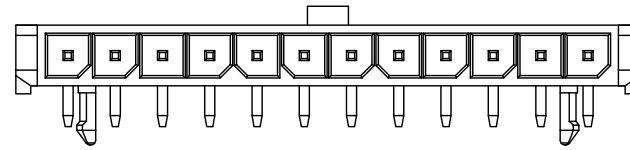

12 POS

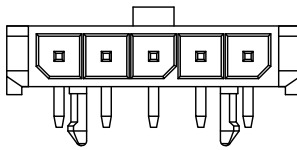

5 POS

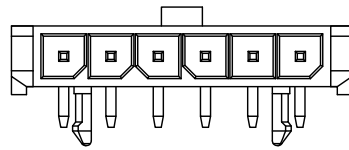

6 POS

METAL BOARDLOCK
OPTION FOR POS2~12

TOLERANCE		APPROVALS		DATE	TITLE		Amphenol®					
X.		DRAWN	Aqua Chou	05/13/2016	G88MP SERIES MICRO POWER PLUS 3.0 PITCH S/R R/A DIP TYPE		Amphenol Corporation Amphenol Taiwan Corporation					
X.X	±0.30	CHECKED	Roger Tsai	05/13/2016								
X.XXX	±0.20	APPROVED	Roger Tsai	05/13/2016								
X.XXX	±0.10	DWG TYPE		PROJECT CODE		UNIT	mm	SIZE	A3	PART No.	G88MPBXX0X2XXEU	
ANGULAR	±1°	CUST DWG		PHD		SCALE	NA	SHEET	2 OF 5	DWG No.	G88MPBXX0X2XXEU	REV.
UNLESS OTHERWISE SPECIFIED												

This document is the property of Amphenol Corporation and is delivered on the express condition that is not to be disclosed, reproduced or used, in whole or in part, for manufacture or sale by anyone other than Amphenol Corporation without its prior consent, and that no right is granted to disclose or to use any information in this document.

The marking on this product doesn't contain environmental hazardous materials per Material Specification 55-00259 for Sony GP compliant or per directive 2011/65/EU for RoHS compliant.



ORIGINAL



REVISIONS				
SYM	ECN No.	DESCRIPTION	DATE	APPROVED
A	NE-14096	RELEASE TO PRODUCTION	05/21/2014	Arron Lin
B	NE-15016	COMBINE DRAWING FOR PACKAGE AND TAIL OPTIONS.	02/02/2015	Arron Lin
C	NE-16117	ADDED METAL BOARDLOCK OPTION	05/13/2016	Roger Tsai

POS.	BOARD-MOUNT P/N	CABLE HOUSING P/N	CABLE TERMINAL P/N	AWG NO.	PLATING OPTIONS
02	G88MPB020X2XXEU	G88MPH0221CEU	G88MPCX232CEU	AWG#16~18	0: TIN 100u" ; 1: FLASH GOLD
			G88MPCX332CEU	AWG#20~30	2: 15u" GOLD ; 3: 30u" GOLD
03	G88MPB030X2XXEU	G88MPH0321CEU	G88MPCX232CEU	AWG#16~18	0: TIN 100u" ; 1: FLASH GOLD
			G88MPCX332CEU	AWG#20~30	2: 15u" GOLD ; 3: 30u" GOLD
04	G88MPB040X2XXEU	G88MPH0421CEU	G88MPCX232CEU	AWG#16~18	0: TIN 100u" ; 1: FLASH GOLD
			G88MPCX332CEU	AWG#20~30	2: 15u" GOLD ; 3: 30u" GOLD
05	G88MPB050X2XXEU	G88MPH0521CEU	G88MPCX232CEU	AWG#16~18	0: TIN 100u" ; 1: FLASH GOLD
			G88MPCX332CEU	AWG#20~30	2: 15u" GOLD ; 3: 30u" GOLD
06	G88MPB060X2XXEU	G88MPH0621CEU	G88MPCX232CEU	AWG#16~18	0: TIN 100u" ; 1: FLASH GOLD
			G88MPCX332CEU	AWG#20~30	2: 15u" GOLD ; 3: 30u" GOLD
07	G88MPB070X2XXEU	G88MPH0721EU	G88MPCX232CEU	AWG#16~18	0: TIN 100u" ; 1: FLASH GOLD
			G88MPCX332CEU	AWG#20~30	2: 15u" GOLD ; 3: 30u" GOLD
08	G88MPB080X2XXEU	G88MPH0821CEU	G88MPCX232CEU	AWG#16~18	0: TIN 100u" ; 1: FLASH GOLD
			G88MPCX332CEU	AWG#20~30	2: 15u" GOLD ; 3: 30u" GOLD
09	G88MPB090X2XXEU	G88MPH0921CEU	G88MPCX232CEU	AWG#16~18	0: TIN 100u" ; 1: FLASH GOLD
			G88MPCX332CEU	AWG#20~30	2: 15u" GOLD ; 3: 30u" GOLD
10	G88MPB100X2XXEU	G88MPH1021CEU	G88MPCX232CEU	AWG#16~18	0: TIN 100u" ; 1: FLASH GOLD
			G88MPCX332CEU	AWG#20~30	2: 15u" GOLD ; 3: 30u" GOLD
11	G88MPB110X2XXEU	G88MPH1121CEU	G88MPCX232CEU	AWG#16~18	0: TIN 100u" ; 1: FLASH GOLD
			G88MPCX332CEU	AWG#20~30	2: 15u" GOLD ; 3: 30u" GOLD
12	G88MPB120X2XXEU	G88MPH1221CEU	G88MPCX232CEU	AWG#16~18	0: TIN 100u" ; 1: FLASH GOLD
			G88MPCX332CEU	AWG#20~30	2: 15u" GOLD ; 3: 30u" GOLD

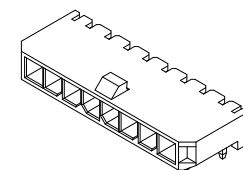

AMPHENOL BOARD-MOUNT

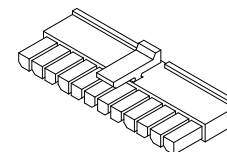

AMPHENOL CABLE HOUSING

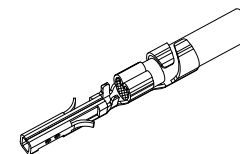

AMPHENOL CABLE TERMINAL

NOTE:
TO ENSURE CURRENT RATING CAPABILITY,
PLEASE ADOPT TOTAL SOLUTION.
(G88MPH CABLE HOUSING SERIES WITH
G88MPC CABLE TERMINAL SERIES)

TOLERANCE		APPROVALS		DATE	TITLE		Amphenol®							
X.		DRAWN	Aqua Chou	05/13/2016	G88MP SERIES MICRO POWER PLUS 3.0 PITCH S/R R/A DIP TYPE		Amphenol Corporation Amphenol Taiwan Corporation							
X.X	±0.30	CHECKED	Roger Tsai	05/13/2016										
X.XX	±0.20	APPROVED	Roger Tsai	05/13/2016										
X.XXX	±0.10						UNIT	mm	SIZE	A3	PART No.	G88MPBXX0X2XXEU		
ANGULAR	±1°						SCALE	NA	SHEET	3 OF 5	DWG No.	G88MPBXX0X2XXEU	REV.	C
UNLESS OTHERWISE SPECIFIED		DWG TYPE		CUST DWG	PROJECT CODE		PHD							

This document is the property of Amphenol Corporation and is delivered on the express condition that is not to be disclosed, reproduced or used, in whole or in part, for manufacture or sale by anyone other than Amphenol Corporation without its prior consent, and that no right is granted to disclose or to use any information in this document.

The marking on this product doesn't contain environmental hazardous materials per Material Specification SS-00259 for Sony GP compliant or per directive 2011/65/EU for RoHS compliant.



ORIGINAL



REVISIONS				
SYM	ECN No.	DESCRIPTION	DATE	APPROVED
A	NE-14096	RELEASE TO PRODUCTION	05/21/2014	Arron Lin
B	NE-15016	COMBINE DRAWING FOR PACKAGE AND TAIL OPTIONS.	02/02/2015	Arron Lin
C	NE-16117	ADDED METAL BOARDLOCK OPTION	05/13/2016	Roger Tsai



POS	PCS/TRAY	PCS/CARTON
02	574	8610
03	434	6510
04	350	5250
05	294	4410
06	252	3780
07	224	3360
08	196	2940
09	182	2730
10	154	2310
11	140	2100
12	140	2100

TOLERANCE		APPROVALS		DATE	TITLE		Amphenol®							
X.		DRAWN	Aqua Chou	05/13/2016	G88MP SERIES MICRO POWER PLUS 3.0 PITCH S/R R/A DIP TYPE		Amphenol Corporation Amphenol Taiwan Corporation							
X.X	±0.30	CHECKED	Roger Tsai	05/13/2016										
X.XX	±0.20	APPROVED	Roger Tsai	05/13/2016										
X.XXX	±0.10						UNIT	mm	SIZE	A3	PART No.	G88MPBXX0X2XXEU		
ANGULAR	±1°						SCALE	NA	SHEET	4 OF 5	DWG No.	G88MPBXX0X2XXEU	REV.	C
UNLESS OTHERWISE SPECIFIED		DWG TYPE		CUST DWG	PROJECT CODE		PHD							

This document is the property of Amphenol Corporation and is delivered on the express condition that is not to be disclosed, reproduced or used, in whole or in part, for manufacture or sale by anyone other than Amphenol Corporation without its prior consent, and that no right is granted to disclose or to use any information in this document.

The marking on this product doesn't contain environmental hazardous materials per Material Specification SS-00259 for Sony GP compliant or per directive 2011/65/EU for RoHS compliant.



ORIGINAL



REVISIONS				
SYM	ECN No.	DESCRIPTION	DATE	APPROVED
A	NE-14096	RELEASE TO PRODUCTION	05/21/2014	Arron Lin
B	NE-15016	COMBINE DRAWING FOR PACKAGE AND TAIL OPTIONS.	02/02/2015	Arron Lin
C	NE-16117	ADDED METAL BOARDLOCK OPTION	05/13/2016	Roger Tsai



P/N :	
QTY : XX	
P/O : XXX-XXXXXX-XXX	
DATE : XX / XX / XXXX MM / DD / YYYY	
G.W : XX KG	RoHS
Amphenol Taiwan Corporation	
LABEL1 & LABEL2	

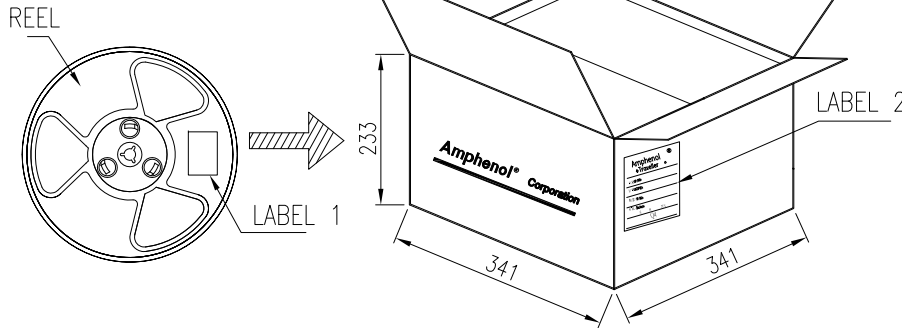

POS	W	PCS/REEL	PCS/CARTON
12	56	400	1200
11	56	400	1200
10	56	400	1200
09	56	400	1200
08	44	400	1600
07	44	400	1600
06	44	400	1600
05	32	400	2000
04	32	400	2000
03	24	400	2800
02	24	400	2800

TOLERANCE		APPROVALS		DATE		TITLE						
X.		DRAWN	Aqua Chou	05/13/2016		G88MP SERIES MICRO POWER PLUS 3.0 PITCH S/R R/A DIP TYPE						
X.X	±0.30	CHECKED	Roger Tsai	05/13/2016								
X.XX	±0.20	APPROVED	Roger Tsai	05/13/2016								
X.XXX	±0.10					UNIT	mm	SIZE	A3	PART No.	G88MPBXXOX2XXEU	
ANGULAR	±1°	DWG TYPE		CUST DWG	PROJECT CODE	PHD	SCALE	NA	SHEET	5 OF 5	DWG No.	G88MPBXXOX2XXEU
UNLESS OTHERWISE SPECIFIED											REV.	C

Amphenol®
Amphenol Corporation
Amphenol Taiwan Corporation

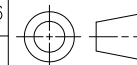



Компания «ЭлектроПласт» предлагает заключение долгосрочных отношений при поставках импортных электронных компонентов на взаимовыгодных условиях!

Наши преимущества:

- Оперативные поставки широкого спектра электронных компонентов отечественного и импортного производства напрямую от производителей и с крупнейших мировых складов;
- Поставка более 17-ти миллионов наименований электронных компонентов;
- Поставка сложных, дефицитных, либо снятых с производства позиций;
- Оперативные сроки поставки под заказ (от 5 рабочих дней);
- Экспресс доставка в любую точку России;
- Техническая поддержка проекта, помощь в подборе аналогов, поставка прототипов;
- Система менеджмента качества сертифицирована по Международному стандарту ISO 9001;
- Лицензия ФСБ на осуществление работ с использованием сведений, составляющих государственную тайну;
- Поставка специализированных компонентов (Xilinx, Altera, Analog Devices, Intersil, Interpoint, Microsemi, Aeroflex, Peregrine, Syfer, Eurofarad, Texas Instrument, Miteq, Cobham, E2V, MA-COM, Hittite, Mini-Circuits, General Dynamics и др.);

Помимо этого, одним из направлений компании «ЭлектроПласт» является направление «Источники питания». Мы предлагаем Вам помощь Конструкторского отдела:

- Подбор оптимального решения, техническое обоснование при выборе компонента;
- Подбор аналогов;
- Консультации по применению компонента;
- Поставка образцов и прототипов;
- Техническая поддержка проекта;
- Защита от снятия компонента с производства.



Как с нами связаться

Телефон: 8 (812) 309 58 32 (многоканальный)

Факс: 8 (812) 320-02-42

Электронная почта: org@eplast1.ru

Адрес: 198099, г. Санкт-Петербург, ул. Калинина, дом 2, корпус 4, литера А.