

HDSM-281x/283x

0.28" (7.0mm)

Single digit surface mount LED display



Data Sheet

Description

The HDSM-281x/283x is a single digit display of 0.28" (7.0mm) height. This device utilizes AlInGaP / GaAs chips and has a grey top surface with white segments.

Features

- 0.28" digit height
- Low current operation
- Excellent characters appearance
- Available in CA and CC
- 1000 pieces per reel
- Moisture sensitivity level: Level 3
- RoHS compliant

Ordering Information

Red	Green	Yellow	Orange	Description
HDSM-281C	HDSM-281H	HDSM-281F	HDSM-281L	Common Anode, Upper and Lower Decimal
HDSM-283C	HDSM-283H	HDSM-283F	HDSM-283L	Common Cathode, Upper and Lower Decimal

Package Dimensions

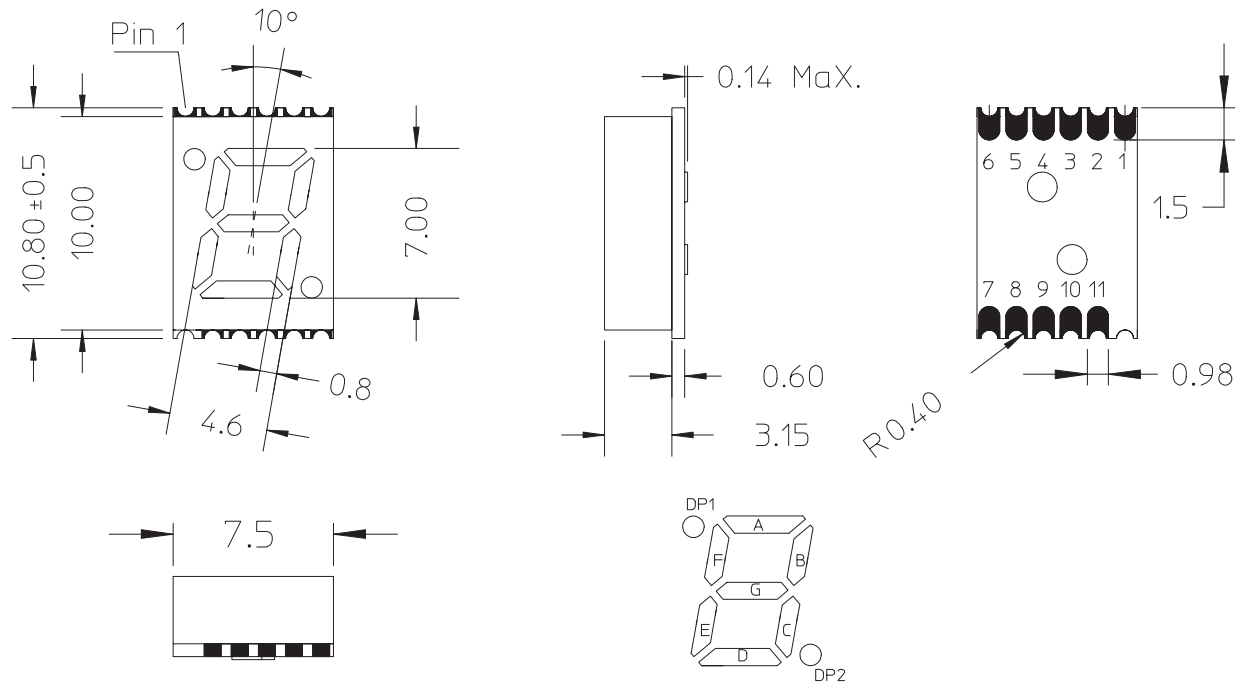

Notes:

All dimensions are in millimeters (inches).

Tolerance: ± 0.25mm (0.01") unless otherwise noted.

Pin Connection (Common Anode)

PIN No	Connection
1	CATHODE G
2	CATHODE DP1
3	CATHODE F
4	COMMON ANODE
5	CATHODE A
6	CATHODE B
7	CATHODE DP2
8	CATHODE C
9	COMMON ANODE
10	CATHODE D
11	CATHODE E

Pin Connection (Common Cathode)

PIN No	Connection
1	ANODE G
2	ANODE DP1
3	ANODE F
4	COMMON CATHODE
5	ANODE A
6	ANODE B
7	ANODE DP2
8	ANODE C
9	COMMON CATHODE
10	ANODE D
11	ANODE E

Internal Circuit Diagram (Common Anode)

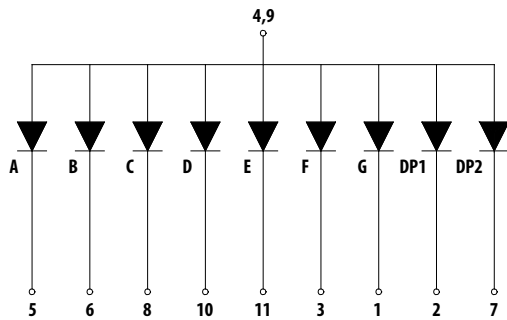

Internal Circuit Diagram (Common Cathode)

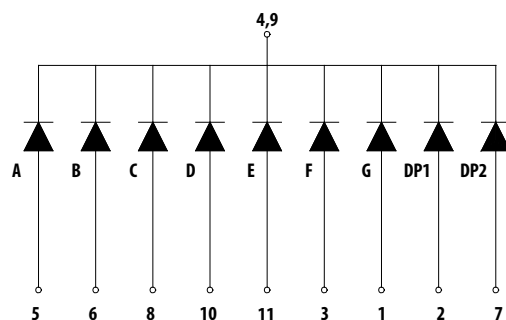

Absolute Maximum Ratings @ $T_A=25^\circ$

Parameter	Green/Yellow/Red/Orange	Unit
Power Dissipation Per Segment	65	mW
Peak Forward Current Per Segment (1/10 Duty Cycle, .0.1ms pulse width)	100	mA
Continuous Forward Current Per Segment Derating Linearly From 25°C Per Segment	25 0.25	mA mA/°C
Reverse Voltage Per Segment	5	V
Operating Temperature Range	-40°C to +105°C	
Storage Temperature Range	-40°C to +105°C	

Electrical / Optical Characteristics @ T_A=25°C

Green

Parameters	Symbol	Min	Typ	Max	Unit	Test Condition
Average Luminous Intensity	I _V	3.4	6	-	mcd	I _F = 10mA
Emissions Wavelength	η _p /λ _d	-	572/571	-	nm	I _F = 20mA
Spectral Line Half-Width	Δλ	-	20	-	nm	I _F = 20mA
Forward Voltage, Per Segment	V _F	-	2.1	2.6	V	I _F = 20mA
Reverse Current, Per Segment	I _R	-	-	100	μA	V _R = 5V
Luminous Intensity Matching Ratio	I _{V-M}	-	-	2:1	-	I _F = 10mA

Yellow

Parameters	Symbol	Min	Typ	Max	Unit	Test Condition
Average Luminous Intensity	I _V	3.4	8.0	-	mcd	I _F = 10mA
Emissions Wavelength	λ _p /λ _d	-	591/589	-	nm	I _F = 20mA
Spectral Line Half-Width	Δλ	-	15	-	nm	I _F = 20mA
Forward Voltage, Per Segment	V _F	-	2.1	2.6	V	I _F = 20mA
Reverse Current, Per Segment	I _R	-	-	100	μA	V _R = 5V
Luminous Intensity Matching Ratio	I _{V-M}	-	-	2:1	-	I _F = 10mA

Red

Parameters	Symbol	Min	Typ	Max	Unit	Test Condition
Average Luminous Intensity	I _V	3.4	7.5	-	mcd	I _F = 10mA
Emissions Wavelength	λ _p /λ _d	-	632/624	-	nm	I _F = 20mA
Spectral Line Half-Width	Δλ	-	20	-	nm	I _F = 20mA
Forward Voltage, Per Segment	V _F	-	2.0	2.6	V	I _F = 20mA
Reverse Current, Per Segment	I _R	-	-	100	μA	V _R = 5V
Luminous Intensity Matching Ratio	I _{V-M}	-	-	2:1	-	I _F = 10mA

Orange

Parameters	Symbol	Min	Typ	Max	Unit	Test Condition
Average Luminous Intensity	I _V	3.4	8.5	-	mcd	I _F = 10mA
Emissions Wavelength	λ _p /λ _d	-	611/605	-	nm	I _F = 20mA
Spectral Line Half-Width	Δλ	-	20	-	nm	I _F = 20mA
Forward Voltage, Per Segment	V _F	-	2.1	2.6	V	I _F = 20mA
Reverse Current, Per Segment	I _R	-	-	100	μA	V _R = 5V
Luminous Intensity Matching Ratio	I _{V-M}	-	-	2:1	-	I _F = 10mA

Typical Electrical / Optical characteristic curves @ $T_A=25^\circ\text{C}$

Green

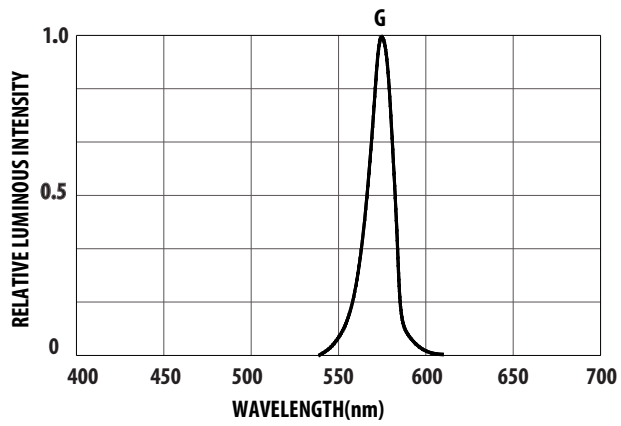

Figure 1. Relative Luminous Intensity vs. Wavelength

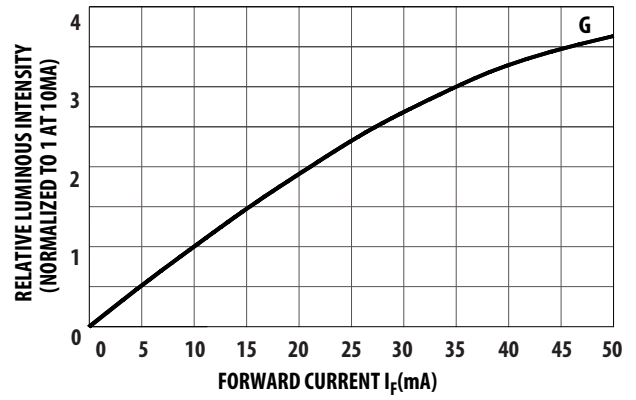

Figure 2. Relative Luminous Intensity vs. Forward Current

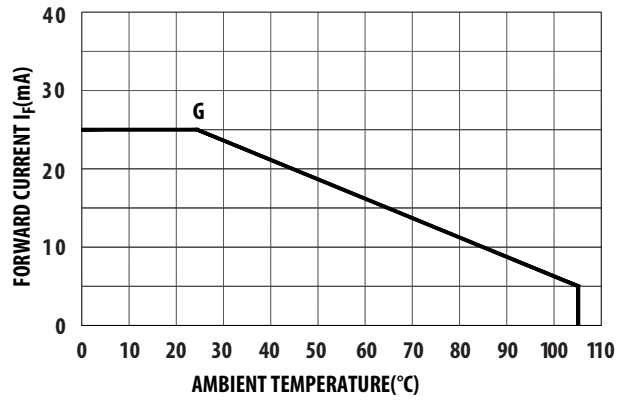

Figure 3. Allowable DC Current vs. Ambient Temperature

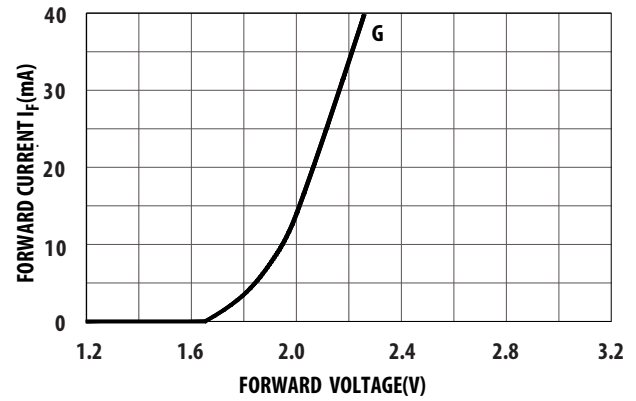

Figure 4. Forward Current vs. Forward Voltage

Yellow

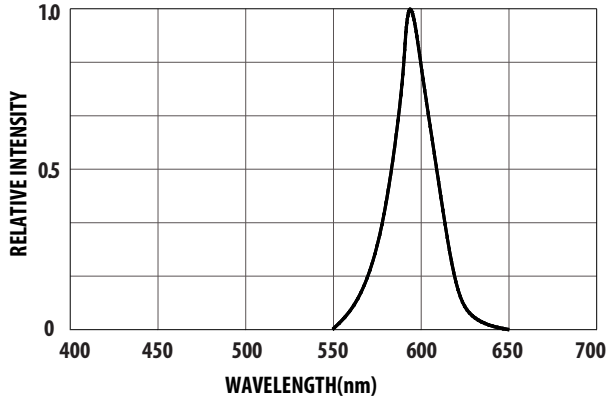

Figure 1. Relative Intensity vs. Wavelength

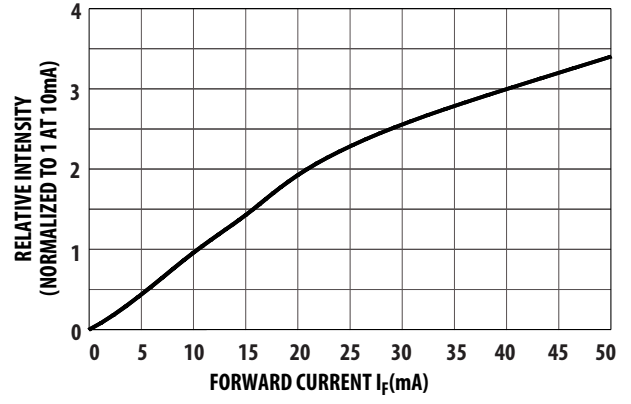

Figure 2. Relative Intensity vs. Forward Current

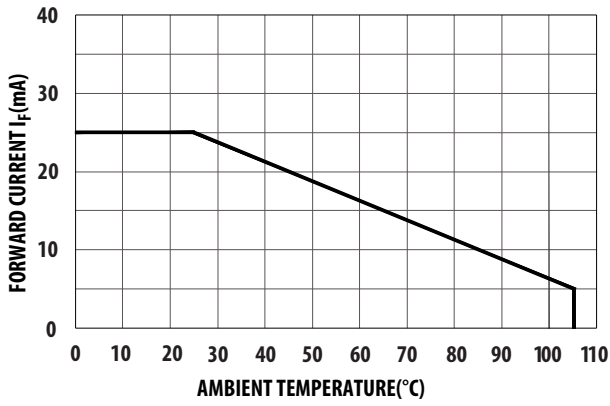

Figure 3. Allowable DC Current vs. Ambient Temperature

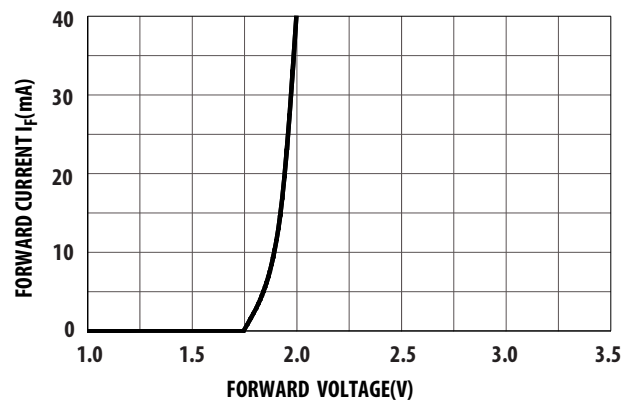

Figure 4. Forward Current vs. Forward Voltage

Red

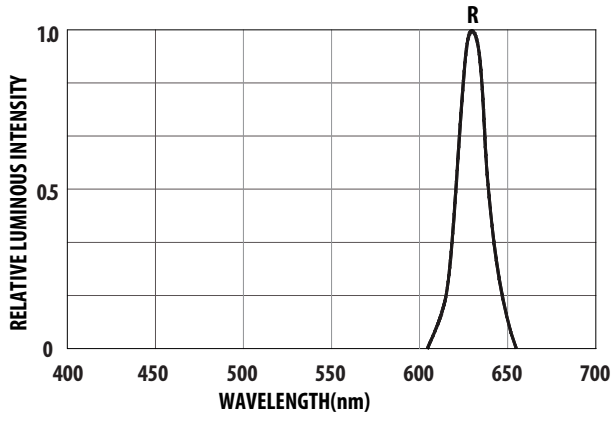

Figure 1. Relative Luminous Intensity vs. Wavelength

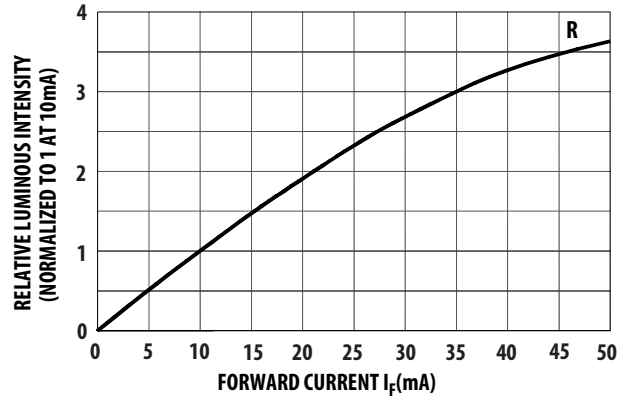

Figure 2. Relative Luminous Intensity vs. Forward Current

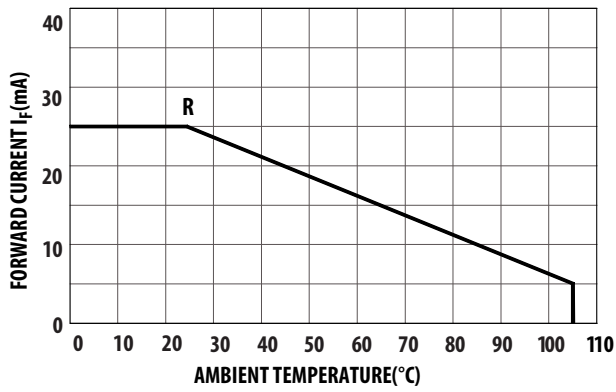

Figure 3. Allowable DC Current vs. Ambient Temperature

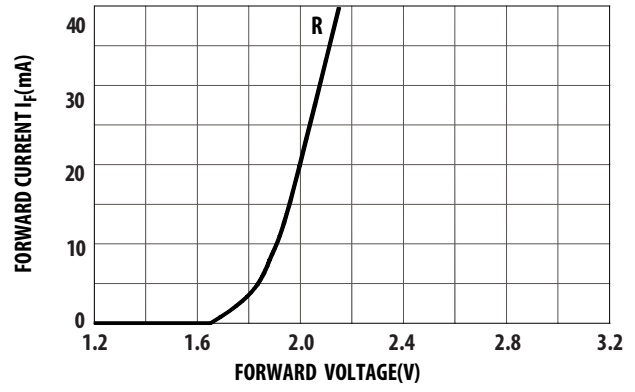

Figure 4. Forward Current vs. Forward Voltage

Orange

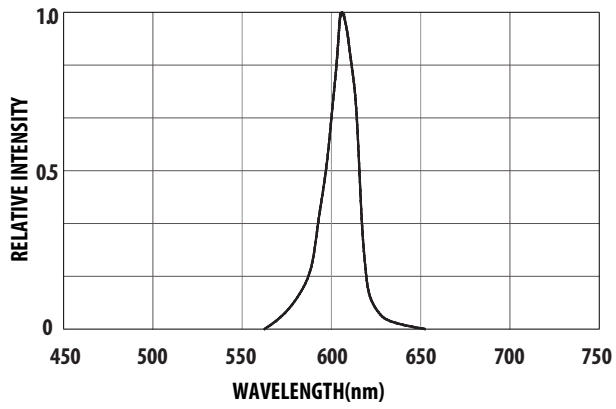

Figure 1. Relative Intensity vs. Wavelength

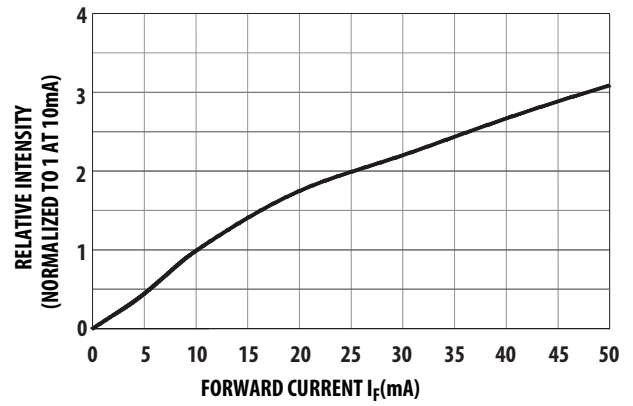

Figure 2. Relative Intensity vs. Forward Current

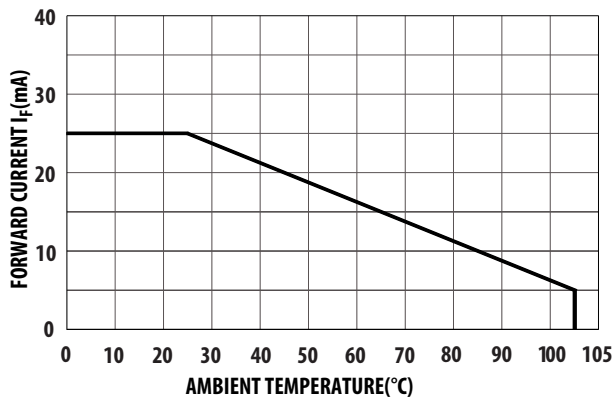

Figure 3. Allowable DC Current vs. Ambient Temperature

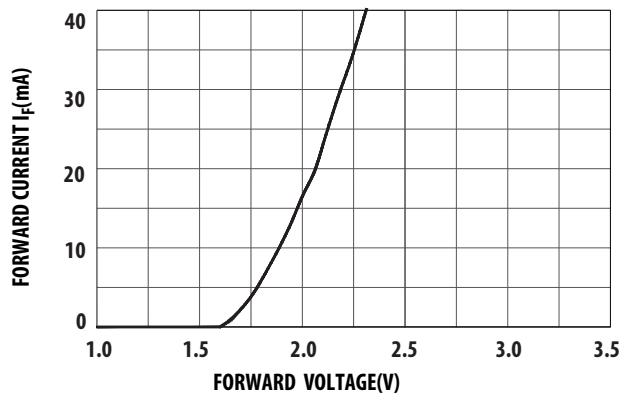

Figure 4. Forward Current vs. Forward Voltage

Intensity Bin Limits (mcd)

Yellow / Red / Orange / Green

IV Bin Category	Min.	Max
L	3.401	5.400
M	5.401	8.600
N	8.601	13.700
P	13.701	21.800

Tolerance: $\pm 15\%$

Notes:

- Bin categories are established for classification of products. Products may not be available in all categories. Please contact your Avago representative for information on currently available bins.

SMT Soldering Profile

Pb free reflow soldering Profile

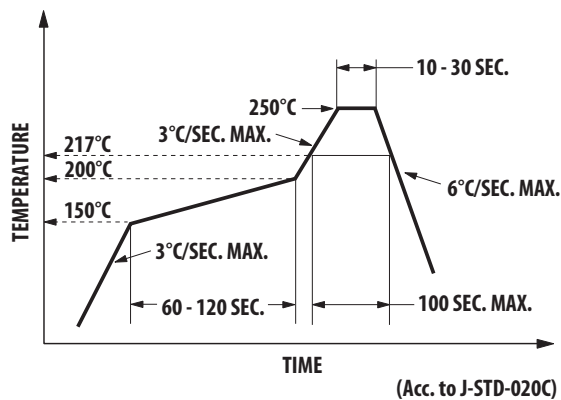

Notes:

- The peak temperature refers to the peak package body temperature.
- Number of reflow process shall be limited to maximum 2 times only. Cooling process to normal temperature is required between first and second soldering process.

Recommended soldering pattern (unit: mm)

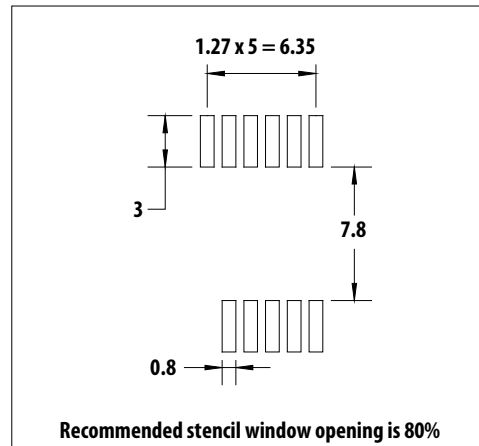

Tape specification (unit: mm)

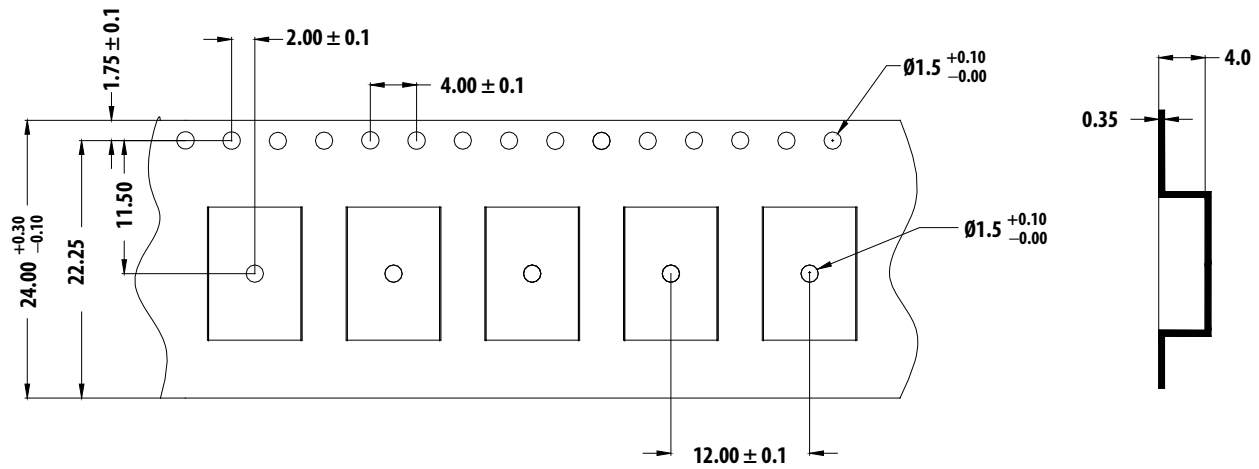

For product information and a complete list of distributors, please go to our web site: www.avagotech.com

Avago, Avago Technologies, and the A logo are trademarks of Avago Technologies in the United States and other countries. Data subject to change. Copyright © 2005-2011 Avago Technologies. All rights reserved. AV02-0980EN - March 17, 2011





Компания «ЭлектроПласт» предлагает заключение долгосрочных отношений при поставках импортных электронных компонентов на взаимовыгодных условиях!

Наши преимущества:

- Оперативные поставки широкого спектра электронных компонентов отечественного и импортного производства напрямую от производителей и с крупнейших мировых складов;
- Поставка более 17-ти миллионов наименований электронных компонентов;
- Поставка сложных, дефицитных, либо снятых с производства позиций;
- Оперативные сроки поставки под заказ (от 5 рабочих дней);
- Экспресс доставка в любую точку России;
- Техническая поддержка проекта, помощь в подборе аналогов, поставка прототипов;
- Система менеджмента качества сертифицирована по Международному стандарту ISO 9001;
- Лицензия ФСБ на осуществление работ с использованием сведений, составляющих государственную тайну;
- Поставка специализированных компонентов (Xilinx, Altera, Analog Devices, Intersil, Interpoint, Microsemi, Aeroflex, Peregrine, Syfer, Eurofarad, Texas Instrument, Miteq, Cobham, E2V, MA-COM, Hittite, Mini-Circuits, General Dynamics и др.);

Помимо этого, одним из направлений компании «ЭлектроПласт» является направление «Источники питания». Мы предлагаем Вам помощь Конструкторского отдела:

- Подбор оптимального решения, техническое обоснование при выборе компонента;
- Подбор аналогов;
- Консультации по применению компонента;
- Поставка образцов и прототипов;
- Техническая поддержка проекта;
- Защита от снятия компонента с производства.



Как с нами связаться

Телефон: 8 (812) 309 58 32 (многоканальный)

Факс: 8 (812) 320-02-42

Электронная почта: org@eplast1.ru

Адрес: 198099, г. Санкт-Петербург, ул. Калинина, дом 2, корпус 4, литера А.