

4

3

2

1

THIS DRAWING IS UNPUBLISHED.

RELEASED FOR PUBLICATION

20

© COPYRIGHT 20

BY TYCO ELECTRONICS CORPORATION. ALL RIGHTS RESERVED.

LOC	DIST	REVISIONS						
		P	LTR	DESCRIPTION	ECN	DATE	DWN	APVD
J	-		A1	PART NO ADDITION		22MAR2007	M.M	D.M
			A2	DRAFTING ERROR	ECR-07-005648	23OCT2007	M.M	S.M
			B	REVISED	ECR-07-025215	07NOV2008	M.M	A.O
			C	REVISED		25NOV2009	Y.O	T.K

2Xn=A

2

3.3

12.8

20.4

C

CAVITY MARK
ALPHABET: CAPITAL LETTER

CIRCUIT NO

① MATERIAL: GLASS FILED THERMO PLASTIC POLYESTER(94V-0), COLOR: BLACK

2. THE SHAPE, SIZE AND POSITION OF THE CHARACTER SHOW THE OUTLINE. THEY DON'T SHOW DETAILS.

3. THE KEYING ARRANGEMENT OF "Y" IS SYMMETRIC WITH "X".

① 材料: ガラス入り熱可塑性ポリエステル樹脂(94V-0), 色: 黒

2. 文字の形状、大きさ、および位置については、大略を示すものであり、詳細を示すものではありません。

3. Y KEY形状はX KEY形状と左右対称

LOGO MARK

SERIES CODE

KEYING: X

12.45

ROW ID

11.3

8.6

9.4

9

B

2Xn=A

2

3.3

1.6

40POS(X-KEY): 1-1827863-0

40	Y	19	38.0	40.9	42.6	2-1827863-0
40	X	19	38.0	40.9	42.6	1-1827863-0
34	Y	16	32.0	34.9	36.6	2-1827863-7
34	X	16	32.0	34.9	36.6	1-1827863-7
32	X	15	30.0	32.9	34.6	1-1827863-6
30	X	14	28.0	30.9	32.6	1-1827863-5
28	X	13	26.0	28.9	30.6	1-1827863-4
26	Y	12	24.0	26.9	28.6	2-1827863-3
26	X	12	24.0	26.9	28.6	1-1827863-3
24	X	11	22.0	24.9	26.6	1-1827863-2
22	X	10	20.0	22.9	24.6	1-1827863-1
POS	KEY	n	A	B	C	PART NO

THIS DRAWING IS A CONTROLLED DOCUMENT FOR TYCO ELECTRONICS CORPORATION IT IS SUBJECT TO CHANGE AND THE CONTROLLING ENGINEERING ORGANIZATION SHOULD BE CONTACTED FOR THE LATEST REVISION.		DWN T. KUDO 16MAR2005	Tyco Electronics Corporation Kawasaki, Japan	
DIMENSIONS: 単位: 概 mm		CHK D. MITSUGI 23AUG2005	NAME DYNAMIC D1100D 2.0mmPITCH REC HSG 22-40POS	
TOLERANCES UNLESS OTHERWISE SPECIFIED: 一般公差 ±0.3, ±5°		APVD D. MITSUGI 23AUG2005	SIZE A3	
0-PLC ±		PRODUCT SPEC 製品規格 108-78268, 78298	CAGE CODE 00779	
1-PLC ±0.1		APPLICATION SPEC 取付適用規格 114-5377	DRAWING NO C-1827863	
2-PLC ±0.02		WEIGHT -	RESTRICTED TO -	
3-PLC ±0.005		CUSTOMER DRAWING	SCALE 2:1	
4-PLC ±0.0005			SHEET 1 OF 3	
ANGLES ±			REV C	
FINISH 仕上 -				

AMP 1470-19 REV 31MAR2000

THIS DRAWING IS UNPUBLISHED.

RELEASED FOR PUBLICATION

20

© COPYRIGHT 20

BY TYCO ELECTRONICS CORPORATION. ALL RIGHTS RESERVED.

LOC	DIST	REVISIONS			
P	LTR	DESCRIPTION	DATE	DWN	APVD
J	-	SEE SHEET 1 OF 3			

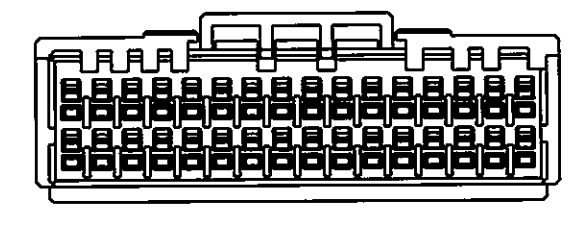
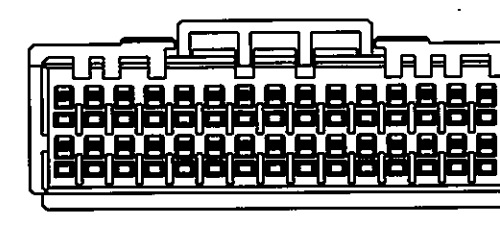
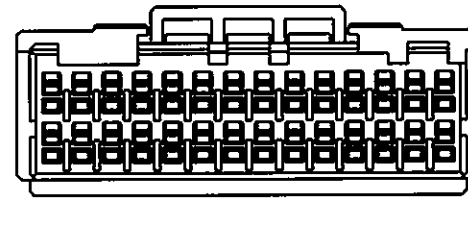
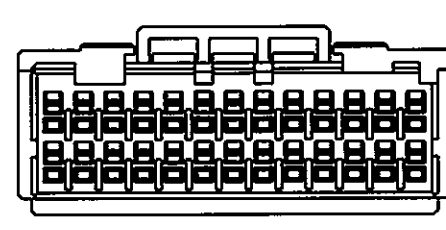
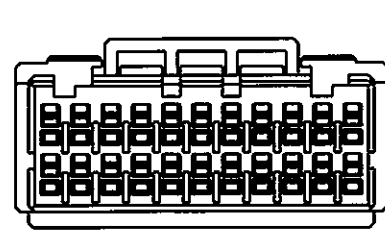
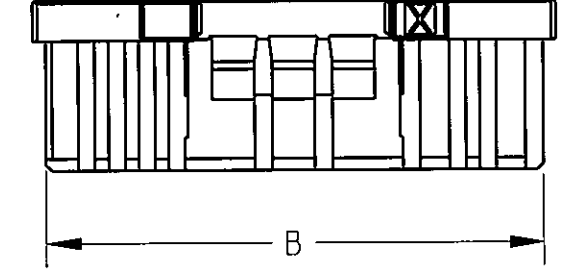
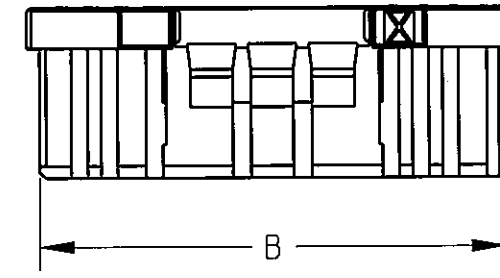
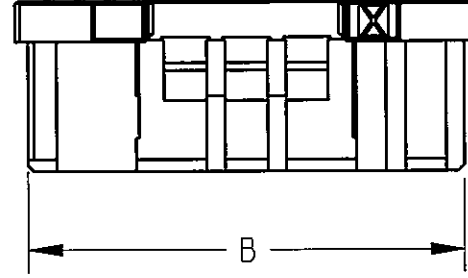
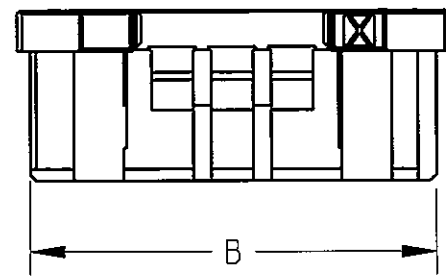
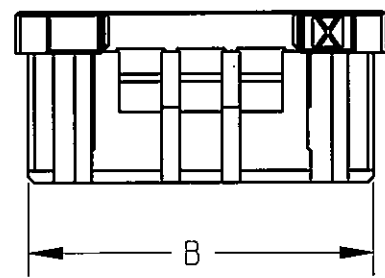
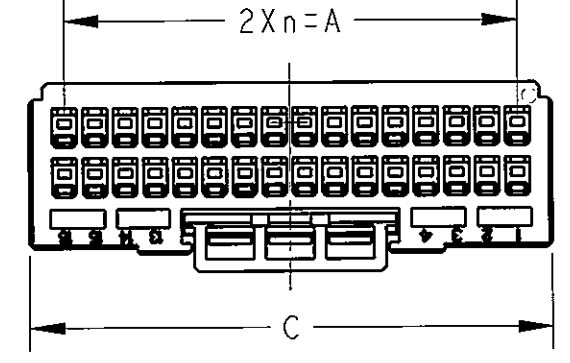
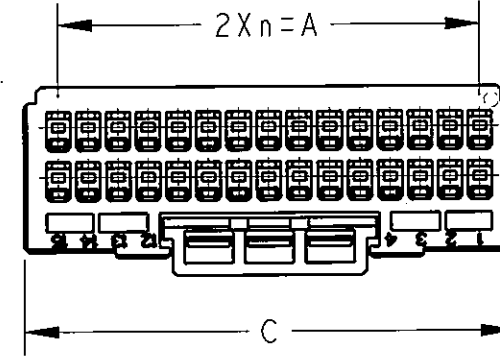
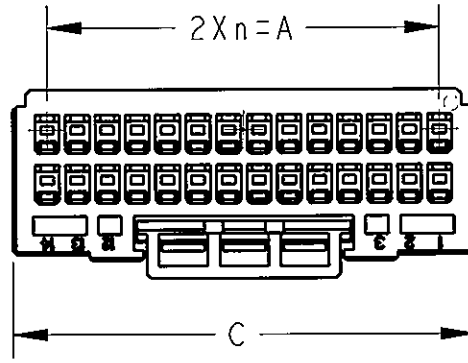
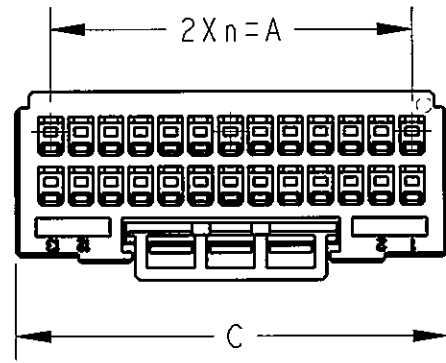
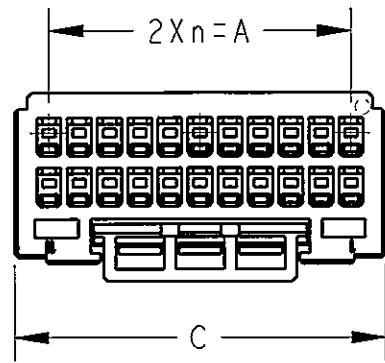

22POS(X-KEY): 1-1827863-1

26POS(X-KEY): 1-1827863-3

28POS(X-KEY): 1-1827863-4

30POS(X-KEY): 1-1827863-5

32POS(X-KEY): 1-1827863-6

<small>THIS DRAWING IS A CONTROLLED DOCUMENT FOR TYCO ELECTRONICS CORPORATION. IT IS SUBJECT TO CHANGE AND THE CONTROLLING ENGINEERING ORGANIZATION SHOULD BE CONTACTED FOR THE LATEST REVISION.</small>		DWN T. KUDO 16MAR2005 CHK D. MITSUGI 23AUG2005 APVD D. MITSUGI 23AUG2005	Tyco Electronics Corporation Kawasaki, Japan			
DIMENSIONS: mm	TOLERANCES UNLESS OTHERWISE SPECIFIED: 0 PLC ± 2 PLC ± 3 PLC ± 4 PLC ± ANGLES ±	PRODUCT SPEC 108-78268, 78298 APPLICATION SPEC 114-5377	NAME DYNAMIC D1100D 2.0mmPITCH REC HSG 22-40POS			
MATERIAL	FINISH	WEIGHT	SIZE	CAGE CODE	DRAWING NO	RESTRICTED TO
			A3	00779	1827863	
CUSTOMER DRAWING			SCALE	SHEET	OF	REV
			2:1	2	3	C

THIS DRAWING IS UNPUBLISHED.

RELEASED FOR PUBLICATION

20

© COPYRIGHT 20

BY TYCO ELECTRONICS CORPORATION. ALL RIGHTS RESERVED.

LOC

DIST

REVISIONS

P

LTR

DESCRIPTION

DATE

DWN

APVD

SEE SHEET 1 OF 3

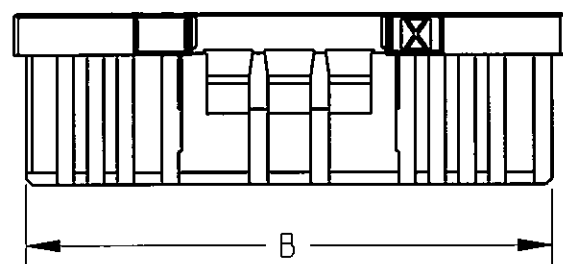
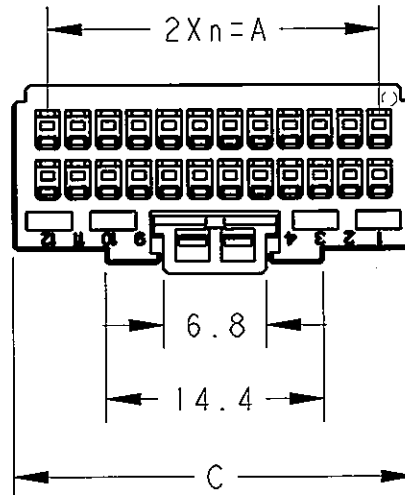
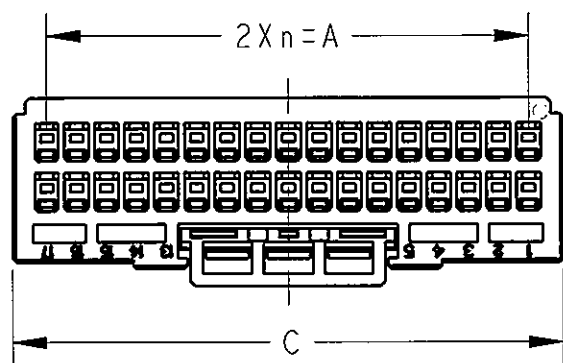

SERIES CODE

LOGO MARK

KEYING: X

ROW ID

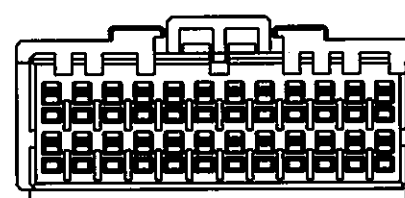
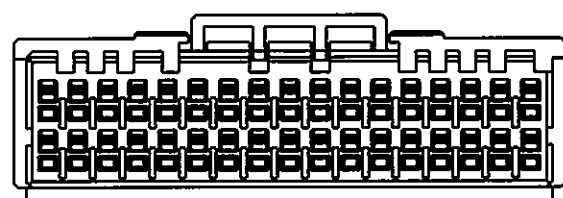
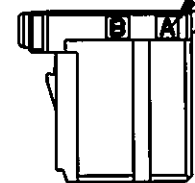
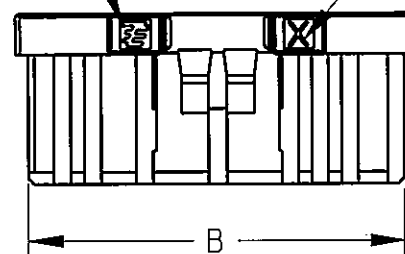
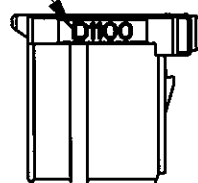

34POS(X-KEY): 1-1827863-7

24POS(X-KEY): 1-1827863-2

<small>THIS DRAWING IS A CONTROLLED DOCUMENT FOR TYCO ELECTRONICS CORPORATION. IT IS SUBJECT TO CHANGE AND THE CONTROLLING ENGINEERING ORGANIZATION SHOULD BE CONTACTED FOR THE LATEST REVISION.</small>		DWN T. KUDO 16MAR2005	Tyco Electronics Corporation Kawasaki, Japan	
DIMENSIONS: mm		CHK D. MITSUGI 23AUG2005	NAME DYNAMIC D1100D 2.0mmPITCH REC HSG 22-40POS	
<small>TOLERANCES UNLESS OTHERWISE SPECIFIED:</small>		APVD D. MITSUGI 23AUG2005		
0 PLC ± 2 PLC ± 3 PLC ± 4 PLC ± ANGLES ±		PRODUCT SPEC 108-78268, 78298	SIZE CAGE CODE DRAWING NO RESTRICTED TO A3 00779 C-1827863 -	
MATERIAL FINISH -		APPLICATION SPEC 114-5377		
		WEIGHT -	SCALE 2:1 SHEET 3 OF 3 REV C	
		CUSTOMER DRAWING		



Компания «ЭлектроПласт» предлагает заключение долгосрочных отношений при поставках импортных электронных компонентов на взаимовыгодных условиях!

Наши преимущества:

- Оперативные поставки широкого спектра электронных компонентов отечественного и импортного производства напрямую от производителей и с крупнейших мировых складов;
- Поставка более 17-ти миллионов наименований электронных компонентов;
- Поставка сложных, дефицитных, либо снятых с производства позиций;
- Оперативные сроки поставки под заказ (от 5 рабочих дней);
- Экспресс доставка в любую точку России;
- Техническая поддержка проекта, помощь в подборе аналогов, поставка прототипов;
- Система менеджмента качества сертифицирована по Международному стандарту ISO 9001;
- Лицензия ФСБ на осуществление работ с использованием сведений, составляющих государственную тайну;
- Поставка специализированных компонентов (Xilinx, Altera, Analog Devices, Intersil, Interpoint, Microsemi, Aeroflex, Peregrine, Syfer, Eurofarad, Texas Instrument, Miteq, Cobham, E2V, MA-COM, Hittite, Mini-Circuits, General Dynamics и др.);

Помимо этого, одним из направлений компании «ЭлектроПласт» является направление «Источники питания». Мы предлагаем Вам помощь Конструкторского отдела:

- Подбор оптимального решения, техническое обоснование при выборе компонента;
- Подбор аналогов;
- Консультации по применению компонента;
- Поставка образцов и прототипов;
- Техническая поддержка проекта;
- Защита от снятия компонента с производства.



Как с нами связаться

Телефон: 8 (812) 309 58 32 (многоканальный)

Факс: 8 (812) 320-02-42

Электронная почта: org@eplast1.ru

Адрес: 198099, г. Санкт-Петербург, ул. Калинина, дом 2, корпус 4, литера А.