



Is Now Part of



ON Semiconductor®

To learn more about ON Semiconductor, please visit our website at
www.onsemi.com

Please note: As part of the Fairchild Semiconductor integration, some of the Fairchild orderable part numbers will need to change in order to meet ON Semiconductor's system requirements. Since the ON Semiconductor product management systems do not have the ability to manage part nomenclature that utilizes an underscore (_), the underscore (_) in the Fairchild part numbers will be changed to a dash (-). This document may contain device numbers with an underscore (_). Please check the ON Semiconductor website to verify the updated device numbers. The most current and up-to-date ordering information can be found at www.onsemi.com. Please email any questions regarding the system integration to Fairchild_questions@onsemi.com.

ON Semiconductor and the ON Semiconductor logo are trademarks of Semiconductor Components Industries, LLC dba ON Semiconductor or its subsidiaries in the United States and/or other countries. ON Semiconductor owns the rights to a number of patents, trademarks, copyrights, trade secrets, and other intellectual property. A listing of ON Semiconductor's product/patent coverage may be accessed at www.onsemi.com/site/pdf/Patent-Marking.pdf. ON Semiconductor reserves the right to make changes without further notice to any products herein. ON Semiconductor makes no warranty, representation or guarantee regarding the suitability of its products for any particular purpose, nor does ON Semiconductor assume any liability arising out of the application or use of any product or circuit, and specifically disclaims any and all liability, including without limitation special, consequential or incidental damages. Buyer is responsible for its products and applications using ON Semiconductor products, including compliance with all laws, regulations and safety requirements or standards, regardless of any support or applications information provided by ON Semiconductor. "Typical" parameters which may be provided in ON Semiconductor data sheets and/or specifications can and do vary in different applications and actual performance may vary over time. All operating parameters, including "Typicals" must be validated for each customer application by customer's technical experts. ON Semiconductor does not convey any license under its patent rights nor the rights of others. ON Semiconductor products are not designed, intended, or authorized for use as a critical component in life support systems or any FDA Class 3 medical devices or medical devices with a same or similar classification in a foreign jurisdiction or any devices intended for implantation in the human body. Should Buyer purchase or use ON Semiconductor products for any such unintended or unauthorized application, Buyer shall indemnify and hold ON Semiconductor and its officers, employees, subsidiaries, affiliates, and distributors harmless against all claims, costs, damages, and expenses, and reasonable attorney fees arising out of, directly or indirectly, any claim of personal injury or death associated with such unintended or unauthorized use, even if such claim alleges that ON Semiconductor was negligent regarding the design or manufacture of the part. ON Semiconductor is an Equal Opportunity/Affirmative Action Employer. This literature is subject to all applicable copyright laws and is not for resale in any manner.

TIL111M, TIL117M, MOC8100M General Purpose 6-Pin Phototransistor Optocouplers

Features

- UL Recognized (File # E90700)
- VDE Recognized (File #102497 for white package)
 - Add Option V (e.g., TIL111VM)

Applications

- Power Supply Regulators
- Digital Logic Inputs
- Microprocessor Inputs
- Appliance Sensor Systems
- Industrial Controls

General Description

The MOC8100M, TIL111M, and TIL117M optocouplers consist of a gallium arsenide infrared emitting diode driving a silicon phototransistor in a 6-pin dual in-line package.

Schematic

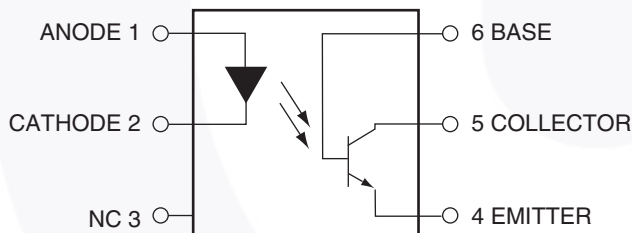

Figure 1. Schematic

Package Outlines

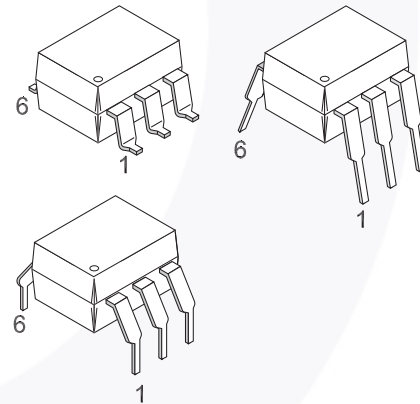

Figure 2. Package Outlines

Safety and Insulation Ratings

As per IEC60747-5-2. This optocoupler is suitable for “safe electrical insulation” only within the safety limit data. Compliance with the safety ratings shall be ensured by means of protective circuits.

Symbol	Parameter	Min.	Typ.	Max.	Unit
	Installation Classifications per DIN VDE 0110/1.89 Table 1 For Rated Mains Voltage < 150 V _{RMS}		I-IV		
	For Rated Mains Voltage < 300 V _{RMS}		I-IV		
	Climatic Classification		55/100/21		
	Pollution Degree (DIN VDE 0110/1.89)		2		
CTI	Comparative Tracking Index	175			
V _{PR}	Input to Output Test Voltage, Method b, V _{IORM} × 1.875 = V _{PR} , 100% Production Test with t _m = 1 s, Partial Discharge < 5 pC	1594			
	Input to Output Test Voltage, Method a, V _{IORM} × 1.5 = V _{PR} , Type and Sample Test with t _m = 60 s, Partial Discharge < 5 pC	1275			
V _{IORM}	Maximum Working Insulation Voltage	850			V _{peak}
V _{IOTM}	Highest Allowable Over Voltage	6000			V _{peak}
	External Creepage	7			mm
	External Clearance	7			mm
	Insulation Thickness	0.5			mm
R _{IO}	Insulation Resistance at T _S , V _{IO} = 500 V	10 ⁹			Ω

Absolute Maximum Ratings

Stresses exceeding the absolute maximum ratings may damage the device. The device may not function or be operable above the recommended operating conditions and stressing the parts to these levels is not recommended. In addition, extended exposure to stresses above the recommended operating conditions may affect device reliability. The absolute maximum ratings are stress ratings only.

Symbol	Parameter	Device	Value	Units
Total Device				
T _{STG}	Storage Temperature	All	-40 to +150	°C
T _{OPR}	Operating Temperature	All	-40 to +100	°C
T _{SOL}	Lead Solder Temperature	All	260 for 10 sec	°C
P _D	Total Device Power Dissipation @ T _A = 25°C Derate Above 25°C	All	250	mW
			2.94	mW/°C
Emitter				
I _F	DC/Average Forward Input Current	All	60	mA
V _R	Reverse Input Voltage	TIL111M	3	V
		MOC8100M, TIL117M	6	
I _{F(pk)}	Forward Current – Peak (300 μs, 2% Duty Cycle)	All	3	A
P _D	LED Power Dissipation @ T _A = 25°C Derate Above 25°C	All	120	mW
			1.41	mW/°C
Detector				
V _{CEO}	Collector-Emitter Voltage	All	30	V
V _{CBO}	Collector-Base Voltage	All	70	V
V _{ECO}	Emitter-Collector Voltage	TIL111M, TIL117M	7	V
V _{EBO}	Emitter-Base Voltage	All	7	
P _D	Detector Power Dissipation @ T _A = 25°C Derate Above 25°C	All	150	mW
			1.76	mW/°C

Electrical Characteristics

$T_A = 25^\circ\text{C}$ unless otherwise specified.

Individual Component Characteristics

Symbol	Parameter	Test Conditions	Device	Min.	Typ.*	Max.	Unit	
Emitter								
V_F	Input Forward Voltage	$I_F = 16\text{ mA}$	$T_A = 25^\circ\text{C}$	TIL111M		1.2	1.4	V
		$I_F = 10\text{ mA}$ for MOC8100M, $I_F = 16\text{ mA}$ for TIL117M	$T_A = 0^\circ\text{C to } 70^\circ\text{C}$	MOC8100M, TIL117M		1.2	1.4	
			$T_A = -55^\circ\text{C}$			1.32		
			$T_A = +100^\circ\text{C}$			1.10		
I_R	Reverse Leakage Current	$V_R = 3.0\text{ V}$		TIL111M, TIL117M		0.001	10	μA
		$V_R = 6.0\text{ V}$		MOC8100M		0.001	10	μA
Detector								
BV_{CEO}	Collector-Emitter Breakdown Voltage	$I_C = 1.0\text{ mA}, I_F = 0$	All	30	100		V	
BV_{CBO}	Collector-Base Breakdown Voltage	$I_C = 10\text{ }\mu\text{A}, I_F = 0$	All	70	120		V	
BV_{EBO}	Emitter-Base Breakdown Voltage	$I_E = 10\text{ }\mu\text{A}, I_F = 0$	All	7	10		V	
BV_{ECO}	Emitter-Collector Breakdown Voltage	$I_F = 100\text{ }\mu\text{A}, I_F = 0$	TIL111M, TIL117M	7	10		V	
I_{CEO}	Collector-Emitter Dark Current	$V_{CE} = 10\text{ V}, I_F = 0$	TIL111M, TIL117M		1	50	nA	
		$V_{CE} = 5\text{ V}, T_A = 25^\circ\text{C}$	MOC8100M		0.5	25	nA	
		$V_{CE} = 30\text{ V}, I_F = 0, T_A = 70^\circ\text{C}$	TIL117M, MOC8100M		0.2	50	μA	
I_{CBO}	Collector-Base Dark Current	$V_{CB} = 10\text{ V}$	TIL111M, TIL117M			20	nA	
		$V_{CB} = 5\text{ V}$	MOC8100M			10	nA	
C_{CE}	Capacitance	$V_{CE} = 0\text{ V}, f = 1\text{ MHz}$	All		8		pF	

*All Typical values at $T_A = 25^\circ\text{C}$

Electrical Characteristics (Continued) $T_A = 25^\circ\text{C}$ unless otherwise specified.**Transfer Characteristics**

Symbol	Parameter	Test Conditions	Device	Min	Typ*	Max	Unit
DC Characteristics							
CTR_{CE}	Current Transfer Ratio, Collector to Emitter	$I_F = 10\text{ mA}, V_{CE} = 10\text{ V}$	TIL117M	50			%
		$I_F = 1\text{ mA}, V_{CE} = 5\text{ V}$	MOC8100M	50			%
		$I_F = 1\text{ mA}, V_{CE} = 5\text{ V}, T_A = 0^\circ\text{C to } +70^\circ\text{C}$		30			
$I_{C(ON)}$	On-State Collector Current (Phototransistor Operation)	$I_F = 16\text{ mA}, V_{CE} = 0.4\text{ V}$	TIL111M	2			mA
	On-State Collector Current (Photodiode Operation)	$I_F = 16\text{ mA}, V_{CB} = 0.4\text{ V}$		7			μA
$V_{CE(SAT)}$	Collector-Emitter Saturation Voltage	$I_C = 500\text{ }\mu\text{A}, I_F = 10\text{ mA}$	TIL117M			0.4	V
		$I_C = 2\text{ mA}, I_F = 16\text{ mA}$	TIL111M			0.4	
		$I_C = 100\text{ }\mu\text{A}, I_F = 1\text{ mA}$	MOC8100M			0.5	
AC Characteristics							
c_{ON}	Turn-On Time	$I_C = 2\text{ mA}, V_{CC} = 10\text{ V}, R_L = 100\text{ }\Omega$ (Fig. 13)	MOC8100M			20	μs
			TIL117M			10	
c_{OFF}	Turn-Off Time		MOC8100M			20	μs
			TIL117M			10	
t_r	Rise Time		MOC8100M		2		μs
t_f	Fall Time		TIL117M		2		
t_r	Rise Time (Phototransistor Operation)	$I_{C(ON)} = 2\text{ mA}, V_{CC} = 10\text{ V}, R_L = 100\text{ }\Omega$ (Fig. 13)	TIL111M			10	μs
t_f	Fall Time (Phototransistor Operation)						

Isolation Characteristics

Symbol	Characteristic	Test Conditions	Min.	Typ.*	Max.	Units
V_{ISO}	Input-Output Isolation Voltage	$f = 60\text{ Hz}, t = 1\text{ s}$	7500			$V_{AC(PK)}$
R_{ISO}	Isolation Resistance	$V_{I-O} = 500\text{ V}_{DC}$	10^{11}			Ω
C_{ISO}	Isolation Capacitance	$V_{I-O} = 0, f = 1\text{ MHz}$		0.2		pF

*All Typical values at $T_A = 25^\circ\text{C}$.

Typical Performance Characteristics

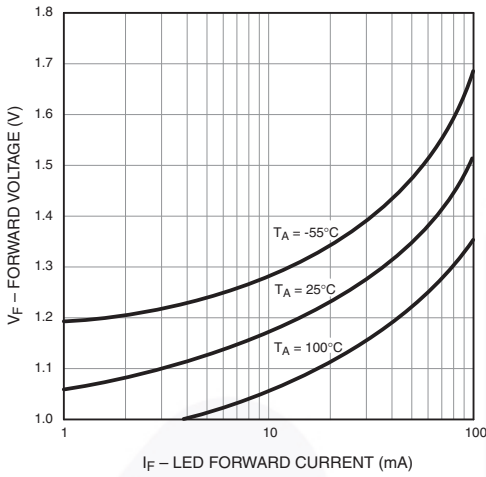

Figure 3. LED Forward Voltage vs. Forward Current

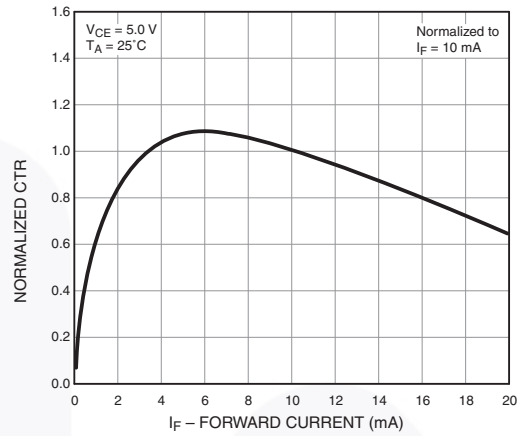

Figure 4. Normalized CTR vs. Forward Current

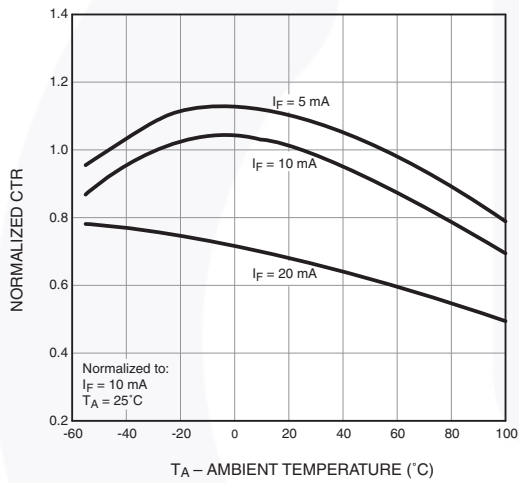

Figure 5. Normalized CTR vs. Ambient Temperature

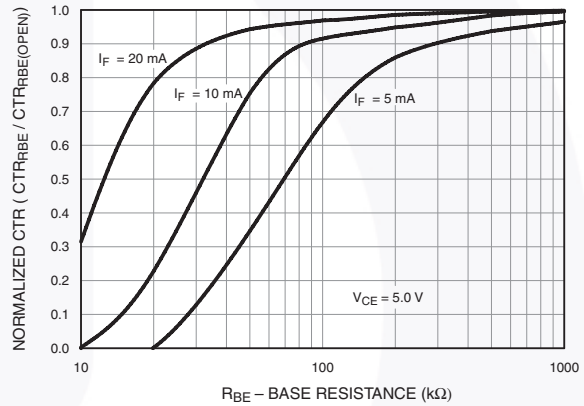

Figure 6. CTR vs. RBE (Unsaturated)

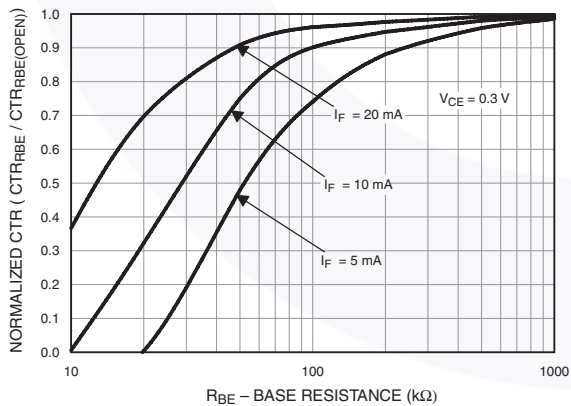

Figure 7. CTR vs. RBE (Saturated)

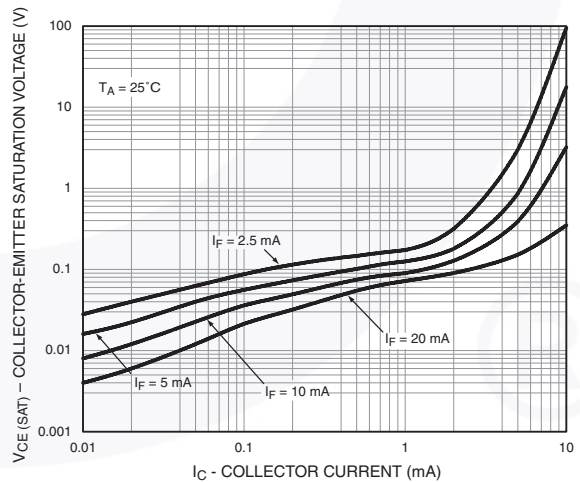

Figure 8. Collector-Emitter Saturation Voltage vs. Collector Current

Typical Performance Characteristics (Continued)

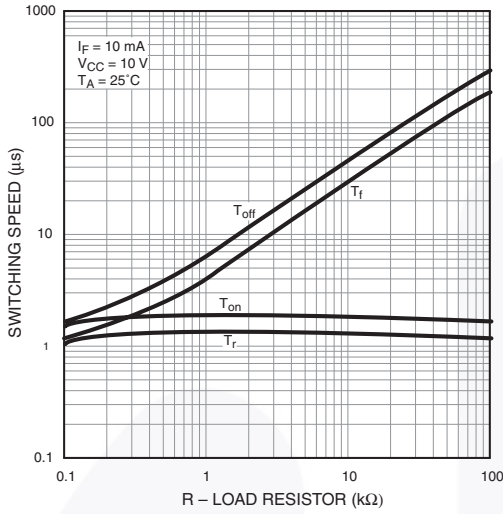

Figure 9. Switching Speed vs. Load Resistor

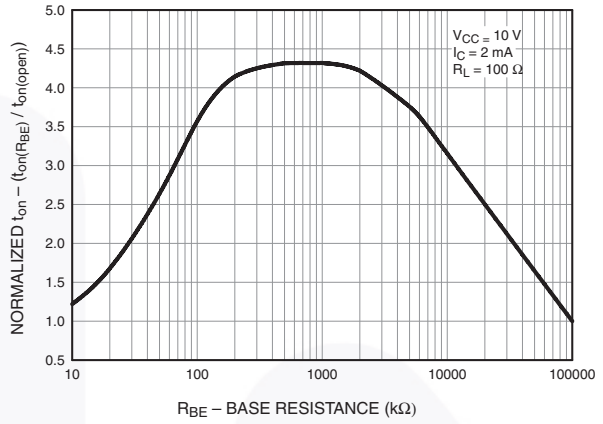

Figure 10. Normalized t_{on} vs. R_{BE}

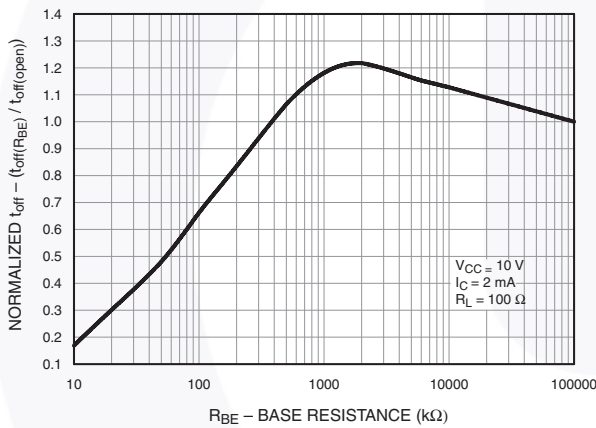

Figure 11. Normalized t_{off} vs. R_{BE}

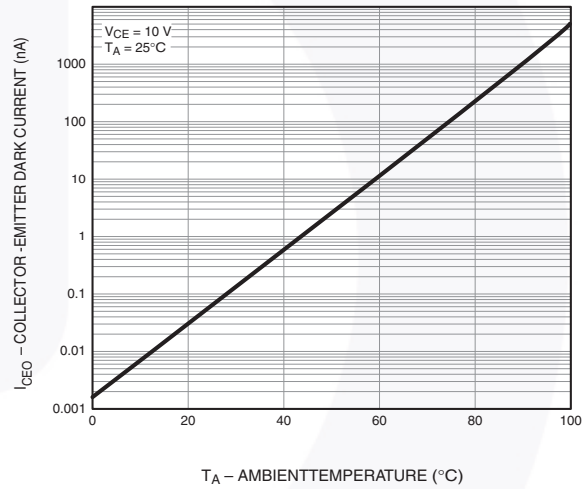

Figure 12. Dark Current vs. Ambient Temperature

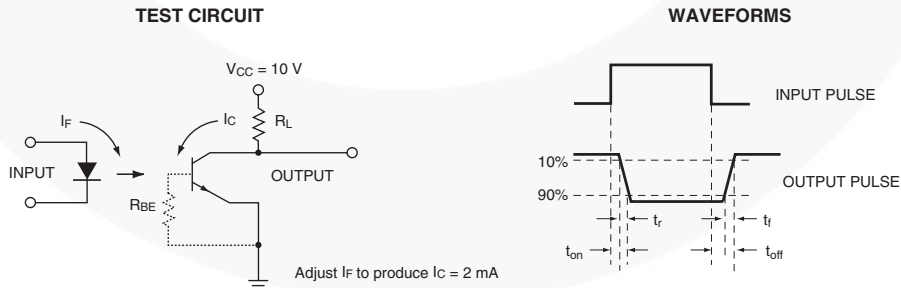

Figure 13. Switching Time Test Circuit and Waveforms

Reflow Profile

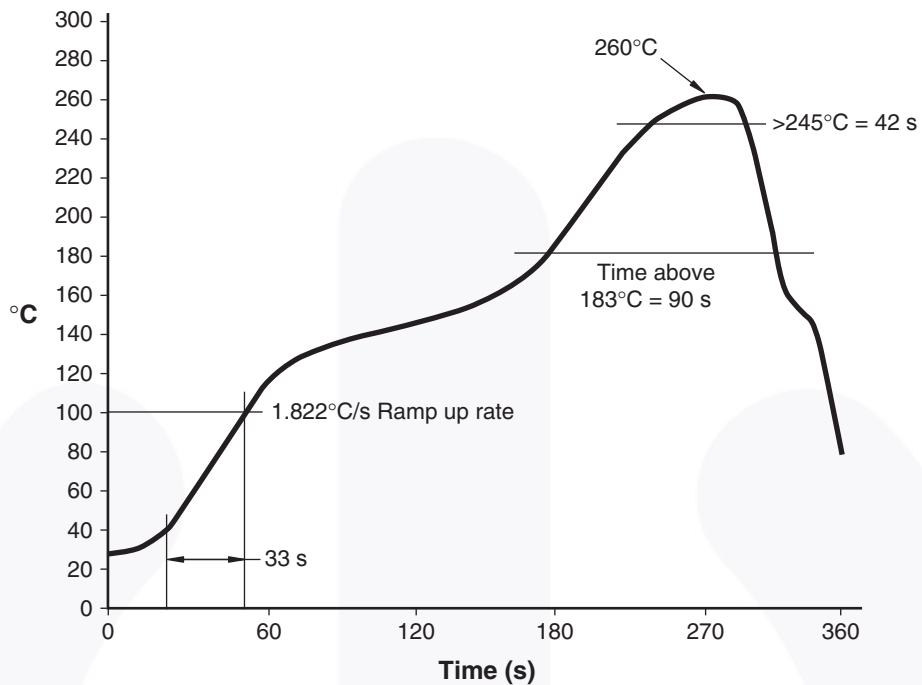
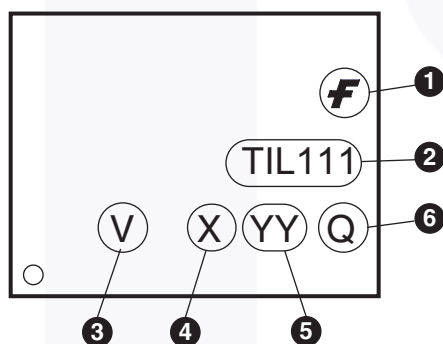

Figure 14. Reflow Profile

Ordering Information

Option	Order Entry Identifier (Example)	Description
No option	TIL111M	Standard Through-Hole Device
S	TIL111SM	Surface Mount Lead Bend
SR2	TIL111SR2M	Surface Mount; Tape and Reel
T	TIL111TM	0.4" Lead Spacing
V	TIL111VM	VDE 0884
TV	TIL111TVM	VDE 0884, 0.4" Lead Spacing
SV	TIL111SVM	VDE 0884, Surface Mount
SR2V	TIL111SR2VM	VDE 0884, Surface Mount, Tape and Reel

Marking Information



Definitions	
1	Fairchild logo
2	Device number
3	VDE mark (Note: Only appears on parts ordered with VDE option – See order entry table)
4	One-digit year code, e.g., '3'
5	Two-digit work week ranging from '01' to '53'
6	Assembly package code

*Note – Parts that do not have the 'V' option (see definition 3 above) that are marked with date code '325' or earlier are marked in portrait format.

Carrier Tape Specification

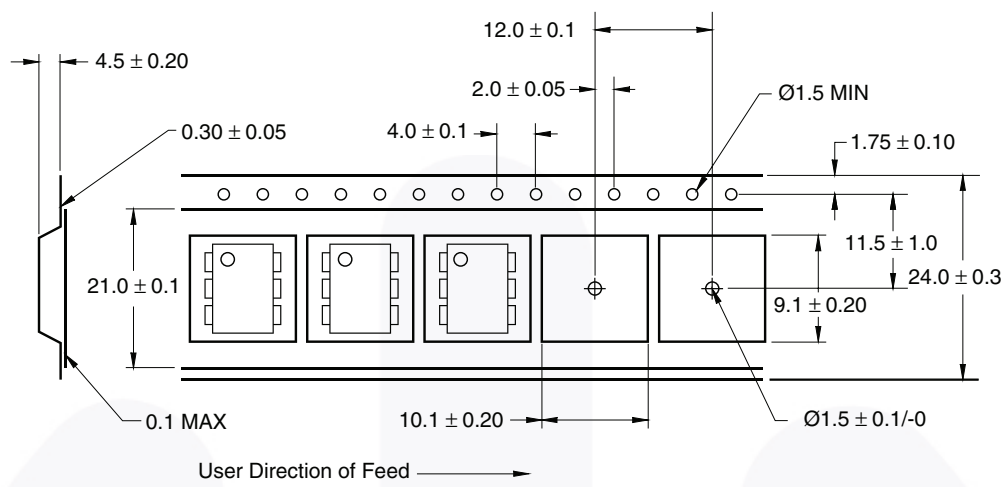
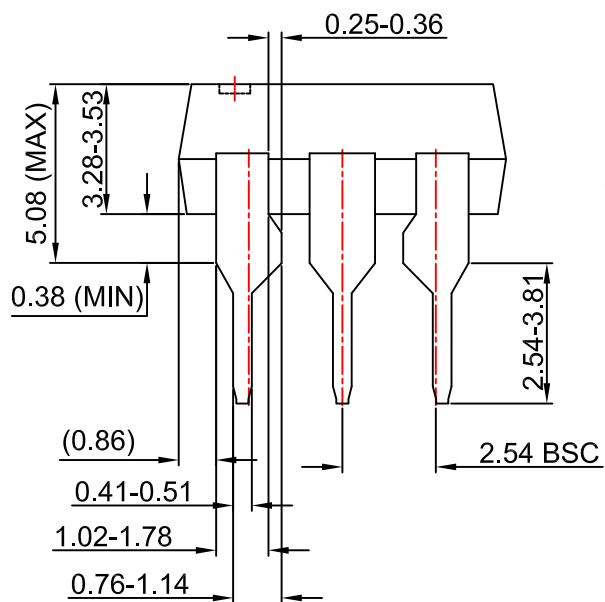
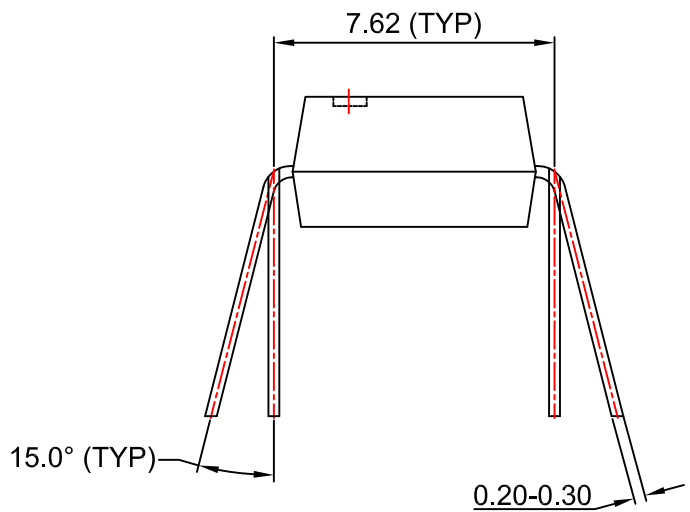
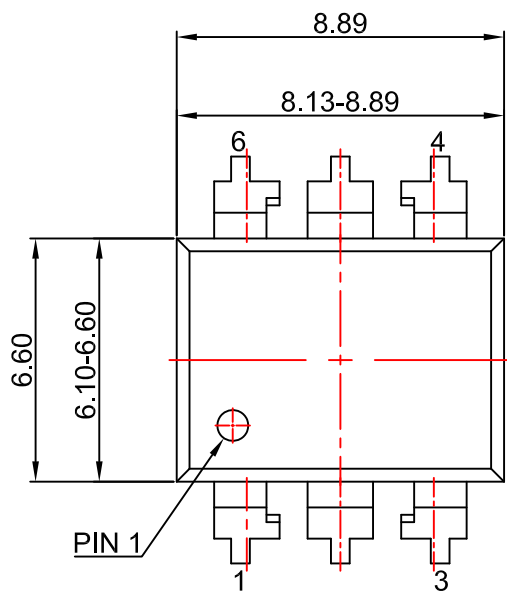

Figure 15. Carrier Tape Specification





NOTES:

- A) NO STANDARD APPLIES TO THIS PACKAGE.
- B) ALL DIMENSIONS ARE IN MILLIMETERS.
- C) DIMENSIONS ARE EXCLUSIVE OF BURRS, MOLD FLASH, AND TIE BAR EXTRUSION
- D) DRAWING FILENAME AND REVISION: MKT-N06BREV4.



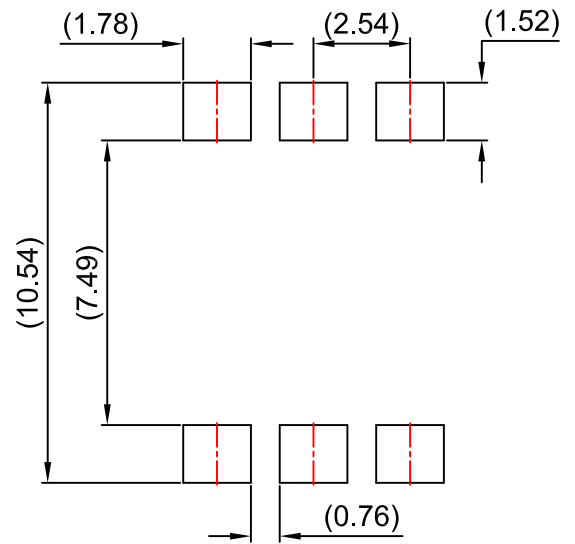
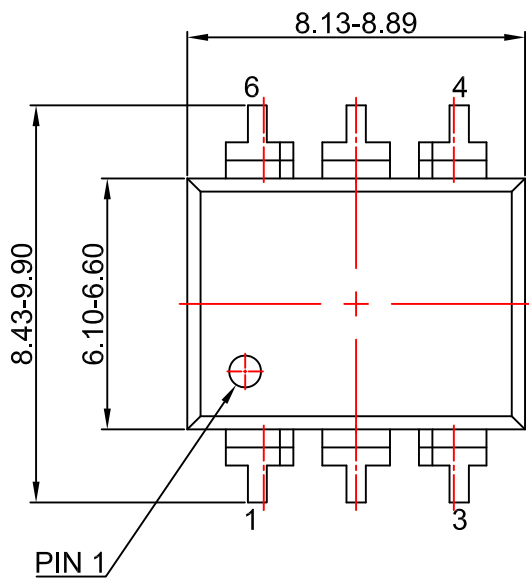

LAND PATTERN RECOMMENDATION

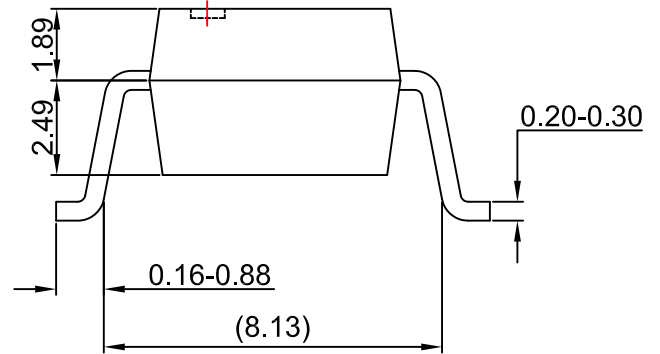
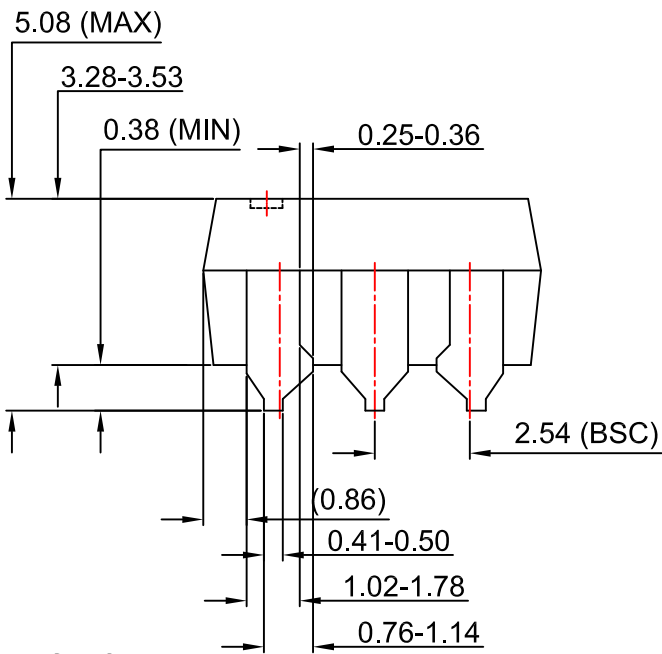

NOTES:

- A) NO STANDARD APPLIES TO THIS PACKAGE.
- B) ALL DIMENSIONS ARE IN MILLIMETERS.
- C) DIMENSIONS ARE EXCLUSIVE OF BURRS, MOLD FLASH, AND TIE BAR EXTRUSION
- D) DRAWING FILENAME AND REVISION : MKT-N06CREV4.



ON Semiconductor and  are trademarks of Semiconductor Components Industries, LLC dba ON Semiconductor or its subsidiaries in the United States and/or other countries. ON Semiconductor owns the rights to a number of patents, trademarks, copyrights, trade secrets, and other intellectual property. A listing of ON Semiconductor's product/patent coverage may be accessed at www.onsemi.com/site/pdf/Patent-Marking.pdf. ON Semiconductor reserves the right to make changes without further notice to any products herein. ON Semiconductor makes no warranty, representation or guarantee regarding the suitability of its products for any particular purpose, nor does ON Semiconductor assume any liability arising out of the application or use of any product or circuit, and specifically disclaims any and all liability, including without limitation special, consequential or incidental damages. Buyer is responsible for its products and applications using ON Semiconductor products, including compliance with all laws, regulations and safety requirements or standards, regardless of any support or applications information provided by ON Semiconductor. "Typical" parameters which may be provided in ON Semiconductor data sheets and/or specifications can and do vary in different applications and actual performance may vary over time. All operating parameters, including "Typicals" must be validated for each customer application by customer's technical experts. ON Semiconductor does not convey any license under its patent rights nor the rights of others. ON Semiconductor products are not designed, intended, or authorized for use as a critical component in life support systems or any FDA Class 3 medical devices or medical devices with a same or similar classification in a foreign jurisdiction or any devices intended for implantation in the human body. Should Buyer purchase or use ON Semiconductor products for any such unintended or unauthorized application, Buyer shall indemnify and hold ON Semiconductor and its officers, employees, subsidiaries, affiliates, and distributors harmless against all claims, costs, damages, and expenses, and reasonable attorney fees arising out of, directly or indirectly, any claim of personal injury or death associated with such unintended or unauthorized use, even if such claim alleges that ON Semiconductor was negligent regarding the design or manufacture of the part. ON Semiconductor is an Equal Opportunity/Affirmative Action Employer. This literature is subject to all applicable copyright laws and is not for resale in any manner.

PUBLICATION ORDERING INFORMATION

LITERATURE FULFILLMENT:

Literature Distribution Center for ON Semiconductor
19521 E. 32nd Pkwy, Aurora, Colorado 80011 USA
Phone: 303-675-2175 or 800-344-3860 Toll Free USA/Canada
Fax: 303-675-2176 or 800-344-3867 Toll Free USA/Canada
Email: orderlit@onsemi.com

N. American Technical Support: 800-282-9855 Toll Free
USA/Canada
Europe, Middle East and Africa Technical Support:
Phone: 421 33 790 2910
Japan Customer Focus Center
Phone: 81-3-5817-1050

ON Semiconductor Website: www.onsemi.com
Order Literature: <http://www.onsemi.com/orderlit>
For additional information, please contact your local
Sales Representative

Mouser Electronics

Authorized Distributor

Click to View Pricing, Inventory, Delivery & Lifecycle Information:

[ON Semiconductor:](#)

[TIL117M](#) [TIL117VM](#) [TIL117M_Q](#)



Компания «ЭлектроПласт» предлагает заключение долгосрочных отношений при поставках импортных электронных компонентов на взаимовыгодных условиях!

Наши преимущества:

- Оперативные поставки широкого спектра электронных компонентов отечественного и импортного производства напрямую от производителей и с крупнейших мировых складов;
- Поставка более 17-ти миллионов наименований электронных компонентов;
- Поставка сложных, дефицитных, либо снятых с производства позиций;
- Оперативные сроки поставки под заказ (от 5 рабочих дней);
- Экспресс доставка в любую точку России;
- Техническая поддержка проекта, помощь в подборе аналогов, поставка прототипов;
- Система менеджмента качества сертифицирована по Международному стандарту ISO 9001;
- Лицензия ФСБ на осуществление работ с использованием сведений, составляющих государственную тайну;
- Поставка специализированных компонентов (Xilinx, Altera, Analog Devices, Intersil, Interpoint, Microsemi, Aeroflex, Peregrine, Syfer, Eurofarad, Texas Instrument, Miteq, Cobham, E2V, MA-COM, Hittite, Mini-Circuits, General Dynamics и др.);

Помимо этого, одним из направлений компании «ЭлектроПласт» является направление «Источники питания». Мы предлагаем Вам помощь Конструкторского отдела:

- Подбор оптимального решения, техническое обоснование при выборе компонента;
- Подбор аналогов;
- Консультации по применению компонента;
- Поставка образцов и прототипов;
- Техническая поддержка проекта;
- Защита от снятия компонента с производства.



Как с нами связаться

Телефон: 8 (812) 309 58 32 (многоканальный)

Факс: 8 (812) 320-02-42

Электронная почта: org@eplast1.ru

Адрес: 198099, г. Санкт-Петербург, ул. Калинина, дом 2, корпус 4, литера А.