



**Small size controlled 3.5 A  
inrush current possible**

## GQ RELAYS TH types



**RoHS compliant**

### FEATURES

1. Small size controlled 3.5 A inrush current possible
2. 2.4 coil voltage type newly available DC battery operation
3. Flat compact size

10.6 (L) × 7.2 (W) × 5.2 (H) mm  
.417 (L) × .283 (W) × .205 (H) inch

### TYPICAL APPLICATIONS

1. Thermostat (HVAC temperature controller)
2. Others, High-capacity control etc.

## ORDERING INFORMATION

	<b>AGQ</b>	<b>2</b>		<b>T</b>				
Contact arrangement 2: 2 Form C								
Operating function 0: Single side stable 1: 1 coil latching								
Type of operation T: Power type (B.B.M.)								
Terminal shape Nil: Standard PC board terminal A: Surface-mount terminal A type S: Surface-mount terminal S type								
Nominal coil voltage (DC) 1H: 1.5V 2H: 2.4V 03: 3V 4H: 4.5V 06: 6V 09: 9V 12: 12V 24: 24V								
Packing style*1 Nil: Tube packing X: Tape and reel packing (picked from 1/2/3/4 pin side) W: Tape and reel packing (picked from the 1/2/3/4-pin side) With humidity indicator and silica gel in moisture proof bag Z: Tape and reel packing (picked from 5/6/7/8 pin side) Y: Tape and reel packing (picked from the 5/6/7/8-pin side) With humidity indicator and silica gel in moisture proof bag								

Note 1) The "W" and "Y" at the end of the part number only appears on the inner and outer packing.  
It does not appear on the relay itself.

## TYPES

### 1. Standard PC board terminal

Nominal coil voltage	Single side stable	1 coil latching
	Part No.	Part No.
1.5 V DC	AGQ20T1H	AGQ21T1H
2.4 V DC	AGQ20T2H	AGQ21T2H
3 V DC	AGQ20T03	AGQ21T03
4.5 V DC	AGQ20T4H	AGQ21T4H
6 V DC	AGQ20T06	AGQ21T06
9 V DC	AGQ20T09	AGQ21T09
12 V DC	AGQ20T12	AGQ21T12
24 V DC	AGQ20T24	AGQ21T24

Standard packing: Tube: 50 pcs.; Case: 1,000 pcs.

2.Surface-mount terminal

1) Tube packing

Nominal coil voltage	Single side stable	1 coil latching
	Part No.	Part No.
1.5 V DC	AGQ20T□1H	AGQ21T□1H
2.4 V DC	AGQ20T□2H	AGQ21T□2H
3 V DC	AGQ20T□03	AGQ21T□03
4.5 V DC	AGQ20T□4H	AGQ21T□4H
6 V DC	AGQ20T□06	AGQ21T□06
9 V DC	AGQ20T□09	AGQ21T□09
12 V DC	AGQ20T□12	AGQ21T□12
24 V DC	AGQ20T□24	AGQ21T□24

□: For each surface-mounted terminal identification, input the following letter. A type: A, S type: S  
 Standard packing: Tube: 50 pcs.; Case: 1,000 pcs.

2) Tape and reel packing

Nominal coil voltage	Single side stable	1 coil latching
	Part No.	Part No.
1.5 V DC	AGQ20T□1HZ	AGQ21T□1HZ
2.4 V DC	AGQ20T□2HZ	AGQ21T□2HZ
3 V DC	AGQ20T□03Z	AGQ21T□03Z
4.5 V DC	AGQ20T□4HZ	AGQ21T□4HZ
6 V DC	AGQ20T□06Z	AGQ21T□06Z
9 V DC	AGQ20T□09Z	AGQ21T□09Z
12 V DC	AGQ20T□12Z	AGQ21T□12Z
24 V DC	AGQ20T□24Z	AGQ21T□24Z

□: For each surface-mounted terminal identification, input the following letter. A type: A, S type: S  
 Standard packing: Tape and reel: 900 pcs.; Case: 1,800 pcs.

Notes: 1. Tape and reel packing symbol "-Z" is not marked on the relay. "X" type tape and reel packing (picked from 1/2/3/4-pin side) is also available.  
 2. Tape and reel packing symbol "-W" is not marked on the relay. "Y" type tape and reel packing (picked from 1/2/3/4-pin side) is also available.  
 3. Please inquire if you require a relay, between 1.5 and 24 V DC, with a voltage not listed.

RATING

1.Coil data

1) Single side stable type

Nominal coil voltage	Pick-up voltage (at 20°C 68°F)	Drop-out voltage (at 20°C 68°F)	Nominal operating current [±10%] (at 20°C 68°F)	Coil resistan [±10%] (at 20°C 68°F)	Nominal operating power	Max. applied voltage (at 20°C 68°F)
1.5 V DC	75%V or less of nominal voltage* (Initial)	10%V or more of nominal voltage* (Initial)	93.8 mA	16 Ω	140 mW	150%V of nominal voltage
2.4 V DC			58.5 mA	41 Ω		
3 V DC			46.7 mA	64.2 Ω		
4.5 V DC			31 mA	145 Ω		
6 V DC			23.3 mA	257 Ω		
9 V DC			15.5 mA	579 Ω		
12 V DC			11.7 mA	1,028 Ω		
24 V DC			9.6 mA	2,504 Ω	230 mW	120%V of nominal voltage

2) 1 coil latching type

Nominal coil voltage	Set voltage (at 20°C 68°F)	Reset voltage (at 20°C 68°F)	Nominal operating current [±10%] (at 20°C 68°F)	Coil resistan [±10%] (at 20°C 68°F)	Nominal operating power	Max. applied voltage (at 20°C 68°F)
1.5 V DC	75%V or less of nominal voltage* (Initial)	75%V or less of nominal voltage* (Initial)	66.7 mA	22.5 Ω	100 mW	150%V of nominal voltage
2.4 V DC			41.7 mA	57.6 Ω		
3 V DC			33.3 mA	90 Ω		
4.5 V DC			22.2 mA	202.5 Ω		
6 V DC			16.7 mA	360 Ω		
9 V DC			11.1 mA	810 Ω		
12 V DC			8.3 mA	1,440 Ω		
24 V DC			5.0 mA	4,800 Ω	120 mW	

\*Pulse drive (JIS C 5442-1996)

## 2. Specifications

Characteristics	Item	Specifications	
Contact	Arrangement	2 Form C	
	Contact resistance (Initial)	Max. 100 mΩ (By voltage drop 6 V DC 1A)	
	Contact material	AgNi + Au plating	
Rating	Nominal switching capacity (resistive)	2 A 30 V DC, 1 A 30 V DC, 0.3 A 125 V AC	
	Max. switching power (resistive)	60 W (DC), 30 W (DC), 37.5 V A (AC)	
	Max. switching voltage	110 V DC, 125 V AC	
	Max. switching current	2 A (AC, DC)	
	Min. switching capacity (Reference value)*1	10 μA 10 mV DC	
	Nominal operating power	Single side stable	140 mW (1.5 to 12 V DC), 230 mW (24 V DC)
		1 coil latching	100 mW (1.5 to 12 V DC), 120 mW (24 V DC)
Electrical characteristics	Insulation resistance (Initial)		Min. 1,000 MΩ (at 500 V DC) Measured portion is the same as the case of dielectric voltage
	Breakdown voltage (Initial)	Between open contacts	750 Vrms for 1 min. (Detection current: 10 mA)
		Between contact and coil	1,500 Vrms for 1 min. (Detection current: 10 mA)
		Between contact sets	1,000 Vrms for 1 min. (Detection current: 10 mA)
	Surge breakdown voltage (Initial)	Between open contacts	1,500 V (10×160 μs) (FCC Part 68)
		Between contact and coil	2,500 V (2×10 μs) (Telcordia)
	Temperature rise (at 20°C 68°F)		Max. 50°C (By resistive method, nominal coil voltage applied to the coil; contact carrying current: 2A)
	Operate time [Set time] (at 20°C 68°F) (Initial)		Max. 4 ms [Max. 4 ms] (Nominal coil voltage applied to the coil, excluding contact bounce time.)
	Release time [Reset time] (at 20°C 68°F) (Initial)		Max. 4 ms [Max. 4 ms] (Nominal coil voltage applied to the coil, excluding contact bounce time.) (without diode)
	Mechanical characteristics	Shock resistance	Functional
Destructive			Min. 1,000 m/s <sup>2</sup> (half -sine shock pulse: 6 ms.)
Vibration resistance		Functional	10 to 55 Hz at double amplitude of 3.3 mm (Detection time: 10 μs.)
		Destructive	10 to 55 Hz at double amplitude of 5.0 mm
Expected life	Mechanical	Min. 5 × 10 <sup>7</sup> (at 180 cpm)	
	Electrical	Min. 1 × 10 <sup>5</sup> (1 A 30 V DC resistive) Min. 1 × 10 <sup>5</sup> (3.5 A inrush (250 ms) / 1 A 30 V AC (cosφ = 0.4)) (ON/OFF=1s/9s)	
Conditions	Conditions for operation, transport and storage*2	Ambient temperature: (Single side stable, 1 coil latching type) -40°C to +85°C -40°F to +185°F Humidity: 5 to 85% R.H. (Not freezing and condensing at low temperature)	
	Max. operating speed (at rated load)	20 cpm	
Unit weight		Approx. 1.0 g .035 oz	

Notes: \*1 This value can change due to the switching frequency, environmental conditions, and desired reliability level, therefore it is recommended to check this with the actual load.  
\*2 Refer to "AMBIENT ENVIRONMENT" in GENERAL APPLICATION GUIDELINES.

## REFERENCE DATA

### 1. Electrical life (1 × 10<sup>5</sup> operation is possible)

Tested sample: AGQ21TA03, 6 pcs.  
Switching frequency: ON:OFF = 1s:9s  
Ambient temperature: 25°C 77°F  
Circuit



### \*Precaution

When using at 3.5A, connection of NO (pin #5 and #8) and COM (pin #4 and #9) in the circuit is required.

Condition: 30V AC  
Inrush current: 3.5A (effective value),  
Inrush time 250ms  
steady current: 1.0A (effective value),  
(Inductive load cosφ = 0.4)

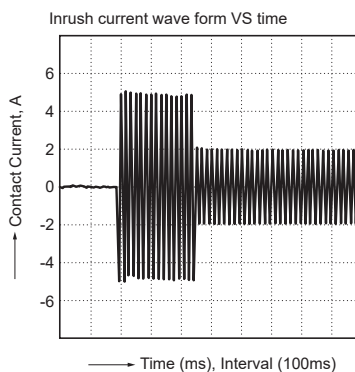

Pin layout and schematic (Bottom View)  
1 coil latching

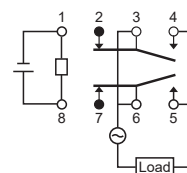

## DIMENSIONS (mm inch)

The CAD data of the products with a **CAD** mark can be downloaded from: <http://industrial.panasonic.com/ac/e/>

### 1.PC board terminal

**CAD**

#### External dimensions

#### PC board pattern

#### Schematic (Bottom view)



Tolerance:  $\pm 0.1 \pm .004$

### 2.Surface-mount terminal

**CAD**



Type	External dimensions		Suggested mouting pad (Tolerance: $\pm 0.1 \pm .004$ )	
	Single side stable/1 coil latching/High sensitivity single side stable		Single side stable/1 coil latching/High sensitivity single side stable	
A type				
S type				

#### Schematic (Top view)

Single side stable

1 coil latching

High sensitivity single side stable

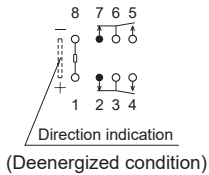

**NOTE**

**1. Packing style**

1) The relay is packed in a tube with the relay orientation mark on the left side, as shown in the figure below.

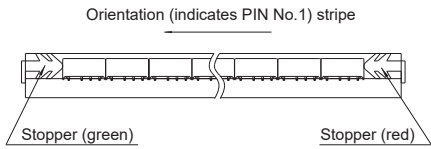
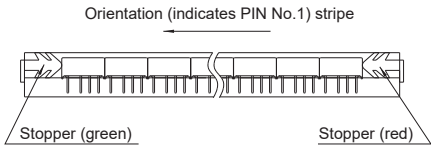

**2) Tape and reel packing**

**(A type)**

**(1)-1 Tape dimensions**

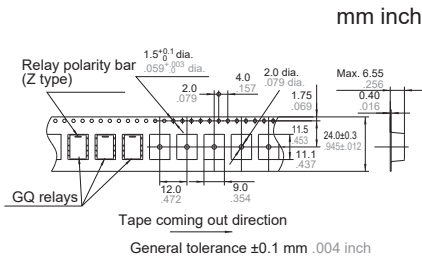

**(S type)**

**(1)-2 Tape dimensions**

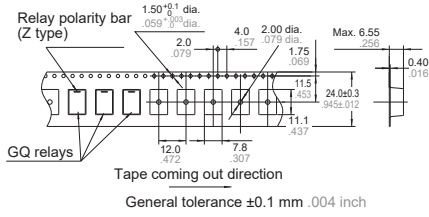

**(2) Dimensions of plastic peel**

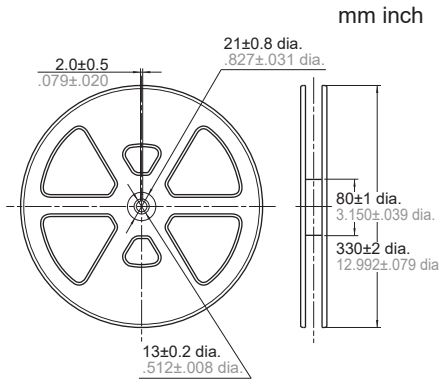

**2. Automatic insertion**

To maintain the internal function of the relay, the chucking pressure should not exceed the values below.

Chucking pressure in the direction A : 9.8 N {1 kgf} or less

Chucking pressure in the direction B : 9.8 N {1 kgf} or less

Chucking pressure in the direction C : 9.8 N {1 kgf} or less

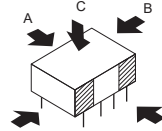

Please chuck the shaded portion. Avoid chucking the center of the relay. In addition, excessive chucking pressure to the pinpoint of the relay should be also avoided.

Please refer to "the latest product specifications" when designing your product.

- Requests to customers : <https://industrial.panasonic.com/ac/e/salespolicies/>

# GUIDELINES FOR SIGNAL RELAYS USAGE

For cautions for use, please read “GUIDELINES FOR RELAY USAGE”.  
[https://industrial.panasonic.com/ac/e/control/relay/cautions\\_use/index.jsp](https://industrial.panasonic.com/ac/e/control/relay/cautions_use/index.jsp)

## Precautions for Coil Input

### ■ Long term current carrying

A circuit that will be carrying a current continuously for long periods without relay switching operation. (circuits for emergency lamps, alarm devices and error inspection that, for example, revert only during malfunction and output warnings with form B contacts) Continuous, long-term current to the coil will facilitate deterioration of coil insulation and characteristics due to heating of the coil itself.

For circuits such as these, please use a magnetic-hold type latching relay. If you need to use a single stable relay, use a sealed type relay that is not easily affected by ambient conditions and make a failsafe circuit design that considers the possibility of contact failure or disconnection.

### ■ DC Coil operating power

Steady state DC current should be applied to the coil. The wave form should be rectangular. If it includes ripple, the ripple factor should be less than 5%.

However, please check with the actual circuit since the electrical characteristics may vary. The rated coil voltage should be applied to the coil and the set/reset pulse time of latching type relay differs for each relays, please refer to the relay's individual specifications.

### ■ Coil connection

When connecting coils of polarized relays, please check coil polarity (+,-) at the internal connection diagram (Schematic). If any wrong connection is made, it may cause unexpected malfunction, like abnormal heat, fire and so on, and circuit do not work. Avoid impressing voltages to the set coil and reset coil at the same time.

### ■ Maximum allowable voltage and temperature rise

Proper usage requires that the rated coil voltage be impressed on the coil. Note, however, that if a voltage greater than or equal to the maximum continuous voltage is impressed on the coil, the coil may burn or its layers short due to the temperature rise. Furthermore, do not exceed the usable ambient temperature range listed in the catalog.

### ● Maximum allowable voltage for coil

In addition to being a requirement for relay operation stability, the maximum continuous impressed coil voltage is an important constraint for the prevention of such problems as thermal deterioration or deformity of the insulation material, or the occurrence of fire hazards.

### ● Temperature rise due to pulse voltage

When a pulse voltage with ON time of less than 2 minutes is used, the coil temperature rise bears no relationship to the ON time. This varies with the ratio of ON time to OFF time, and compared with continuous current passage, it is rather small. The various relays are essentially the same in this respect.

Current passage time	(%)
For continuous passage	Temperature rise value is 100%
ON : OFF = 3 : 1	About 80%
ON : OFF = 1 : 1	About 50%
ON : OFF = 1 : 3	About 35%



### ■ Operate voltage change due to coil temperature rise (Hot start)

In DC relays, after continuous passage of current in the coil, if the current is turned OFF, then immediately turned ON again, due to the temperature rise in the coil, the pick-up voltage will become somewhat higher. Also, it will be the same as using it in a higher temperature atmosphere. The resistance/temperature relationship for copper wire is about 0.4% for 1°C, and with this ratio the coil resistance increases. That is, in order to operate of the relay, it is necessary that the voltage be higher than the pick-up voltage and the pick-up voltage rises in accordance with the increase in the resistance value. However, for some polarized relays, this rate of change is considerably smaller.

# GUIDELINES FOR SIGNAL RELAYS USAGE

## Ambient Environment

### •Dew condensation

Condensation occurs when the ambient temperature drops suddenly from a high temperature and humidity, or the relay and microwave device is suddenly transferred from a low ambient temperature to a high temperature and humidity. Condensation causes the failures like insulation deterioration, wire disconnection and rust etc.

Panasonic Corporation does not guarantee the failures caused by condensation.

The heat conduction by the equipment may accelerate the cooling of device itself, and the condensation may occur.

Please conduct product evaluations in the worst condition of the actual usage. (Special attention should be paid when high temperature heating parts are close to the device. Also please consider the condensation may occur inside of the device.)

### •Icing

Condensation or other moisture may freeze on relays when the temperature become lower than 0°C. This icing causes the sticking of movable portion, the operation delay and the contact conduction failure etc. Panasonic Corporation does not guarantee the failures caused by the icing.

The heat conduction by the equipment may accelerate the cooling of relay itself and the icing may occur. Please conduct product evaluations in the worst condition of the actual usage.

### •Low temperature and low humidity

The plastic becomes brittle if the switch is exposed to a low temperature, low humidity environment for long periods of time.

### •High temperature and high humidity

Storage for extended periods of time (including transportation periods) at high temperature or high humidity levels or in atmospheres with organic gases or sulfide gases may cause a sulfide film or oxide film to form on the surfaces of the contacts and/or it may interfere with the functions. Check out the atmosphere in which the units are to be stored and transported.

### •Package

In terms of the packing format used, make every effort to keep the effects of moisture, organic gases and sulfide gases to the absolute minimum.

### •Storage requirements

Since the SMD type is sensitive to humidity it is packaged with tightly sealed anti-humidity packaging. However, when storing, please be careful of the following.

- 1) Please use promptly once the anti-humidity pack is opened. (Signal relay: within 72 hours, Max. 30°C/70% RH). If left with the pack open, the relay will absorb moisture which will cause thermal stress when reflow mounting and thus cause the case to expand. As a result, the seal may break.

- 2) If relays will not be used within 72 hours, please store relays in a humidity controlled desiccator or in an anti-humidity bag to which silica gel has been added.

\*If the relay is to be soldered after it has been exposed to excessive humidity atmosphere, cracks and leaks can occur. Be sure to mount the relay under the required mounting conditions

- 3) The following cautionary label is affixed to the anti-humidity pack.

**C a u t i o n**

This vacuum-sealed bag contains

**Moisture Sensitive Products**

After this bag is opened, the product must be used

**within 7 2 h o u r s**

If product is not used within 72 hours, baking is necessary.

For baking conditions please contact us.

### •Silicon

When a source of silicone substances (silicone rubber, silicone oil, silicone coating materials and silicone filling materials etc.) is used around the relay, the silicone gas (low molecular siloxane etc.) may be produced.

This silicone gas may penetrate into the inside of the relay. When the relay is kept and used in this condition, silicone compound may adhere to the relay contacts which may cause the contact failure. Do not use any sources of silicone gas around the relay (Including plastic seal types).

### •NOx Generation

When relay is used in an atmosphere high in humidity to switch a load which easily produces an arc, the NOx created by the arc and the water absorbed from outside the relay combine to produce nitric acid. This corrodes the internal metal parts and adversely affects operation. Avoid use at an ambient humidity of 85% RH or higher (at 20°C). If use at high humidity is unavoidable, please contact our sales representative.

## Others

### ■ Cleaning

- 1) Although the environmentally sealed type relay (plastic sealed type, etc.) can be cleaned, avoid immersing the relay into cold liquid (such as cleaning solvent) immediately after soldering. Doing so may deteriorate the sealing performance.
- 2) Surface mount terminal type relay is sealed type and it can be cleaned by immersion. Use pure water or alcohol-based cleaning solvent.

- 3) Cleaning with the boiling method is recommended (The temperature of cleaning liquid should be 40°C or lower).

Avoid ultrasonic cleaning on relays. Use of ultrasonic cleaning may cause breaks in the coil or slight sticking of the contacts due to the ultrasonic energy.

Please refer to "**the latest product specifications**" when designing your product.

•Requests to customers:

<https://industrial.panasonic.com/ac/e/salespolicies/>

---

Please contact .....

**Panasonic Corporation**

Electromechanical Control Business Division

■1006, Oaza Kadoma, Kadoma-shi, Osaka 571-8506, Japan  
[industrial.panasonic.com/ac/e/](http://industrial.panasonic.com/ac/e/)

**Panasonic**<sup>®</sup>

©Panasonic Corporation 2019



# Mouser Electronics

Authorized Distributor

Click to View Pricing, Inventory, Delivery & Lifecycle Information:

## Panasonic:

[AGQ20TS4H](#) [AGQ20T12](#) [AGQ20TA03Z](#) [AGQ21TS4HX](#) [AGQ20TS12](#) [AGQ20TA2HZ](#) [AGQ21TA24Z](#) [AGQ20TS09](#)  
[AGQ21T24](#) [AGQ20TS4HZ](#) [AGQ20T1H](#) [AGQ20TS1HZ](#) [AGQ21TA2HX](#) [AGQ20TS09X](#) [AGQ21TA12X](#)  
[AGQ21TS06X](#) [AGQ20TS03X](#) [AGQ20TA24Z](#) [AGQ21T03](#) [AGQ21TA09](#) [AGQ21TS24](#) [AGQ21TA06](#) [AGQ20TS2HX](#)  
[AGQ20TS24Z](#) [AGQ20TS12Z](#) [AGQ21T1H](#) [AGQ21TA1HX](#) [AGQ20TA06X](#) [AGQ20TS06Z](#) [AGQ20TS2HZ](#)  
[AGQ20TS24X](#) [AGQ21TS2H](#) [AGQ20TA06Z](#) [AGQ21TA1HZ](#) [AGQ21TA1H](#) [AGQ20TS12X](#) [AGQ20TA2H](#)  
[AGQ21TS12Z](#) [AGQ21TS1H](#) [AGQ20TS06X](#) [AGQ21T09](#) [AGQ21TS1HX](#) [AGQ21T06](#) [AGQ20TA1HX](#) [AGQ21TA06X](#)  
[AGQ20TS4HX](#) [AGQ20TS09Z](#) [AGQ21TA03Z](#) [AGQ21TA06Z](#) [AGQ20TA03](#) [AGQ21TS4H](#) [AGQ20TS03](#)  
[AGQ20TS1HX](#) [AGQ20TA12Z](#) [AGQ20TA12](#) [AGQ21TA03](#) [AGQ21TA4HZ](#) [AGQ21TS2HX](#) [AGQ20T09](#) [AGQ20TA03X](#)  
[AGQ21TA24X](#) [AGQ20TA09](#) [AGQ21T2H](#) [AGQ20TA2HX](#) [AGQ21TA12Z](#) [AGQ21TA03X](#) [AGQ20TS2H](#)  
[AGQ21TS24Z](#) [AGQ21TS09](#) [AGQ21TS12X](#) [AGQ20TS24](#) [AGQ20T03](#) [AGQ20T06](#) [AGQ20TS1H](#) [AGQ21TA4H](#)  
[AGQ20TS03Z](#) [AGQ20TA09Z](#) [AGQ20TA06](#) [AGQ21TA12](#) [AGQ21T12](#) [AGQ21TS2HZ](#) [AGQ20TA4HX](#) [AGQ21T4H](#)  
[AGQ21TS03](#) [AGQ20T4H](#) [AGQ21TA2HZ](#) [AGQ21TS12](#) [AGQ20TS06](#) [AGQ21TA2H](#) [AGQ21TS06](#) [AGQ20T24](#)  
[AGQ21TA24](#) [AGQ20TA1HZ](#) [AGQ21TS03X](#) [AGQ20TA24](#) [AGQ20TA4H](#) [AGQ20TA4HZ](#) [AGQ20T2H](#) [AGQ21TS06Z](#)  
[AGQ21TS09X](#)



Компания «ЭлектроПласт» предлагает заключение долгосрочных отношений при поставках импортных электронных компонентов на взаимовыгодных условиях!

Наши преимущества:

- Оперативные поставки широкого спектра электронных компонентов отечественного и импортного производства напрямую от производителей и с крупнейших мировых складов;
- Поставка более 17-ти миллионов наименований электронных компонентов;
- Поставка сложных, дефицитных, либо снятых с производства позиций;
- Оперативные сроки поставки под заказ (от 5 рабочих дней);
- Экспресс доставка в любую точку России;
- Техническая поддержка проекта, помощь в подборе аналогов, поставка прототипов;
- Система менеджмента качества сертифицирована по Международному стандарту ISO 9001;
- Лицензия ФСБ на осуществление работ с использованием сведений, составляющих государственную тайну;
- Поставка специализированных компонентов (Xilinx, Altera, Analog Devices, Intersil, Interpoint, Microsemi, Aeroflex, Peregrine, Syfer, Eurofarad, Texas Instrument, Miteq, Cobham, E2V, MA-COM, Hittite, Mini-Circuits, General Dynamics и др.);

Помимо этого, одним из направлений компании «ЭлектроПласт» является направление «Источники питания». Мы предлагаем Вам помощь Конструкторского отдела:

- Подбор оптимального решения, техническое обоснование при выборе компонента;
- Подбор аналогов;
- Консультации по применению компонента;
- Поставка образцов и прототипов;
- Техническая поддержка проекта;
- Защита от снятия компонента с производства.



#### Как с нами связаться

**Телефон:** 8 (812) 309 58 32 (многоканальный)

**Факс:** 8 (812) 320-02-42

**Электронная почта:** [org@eplast1.ru](mailto:org@eplast1.ru)

**Адрес:** 198099, г. Санкт-Петербург, ул. Калинина, дом 2, корпус 4, литера А.