

DUAL HIGH CURRENT OPERATIONAL AMPLIFIER

■ GENERAL DESCRIPTION

The NJM4556A integrated circuit is a high-gain, high output current dual operational amplifier capable of driving $\pm 70\text{mA}$ into 150Ω loads ($\pm 10.5\text{V}$ output voltage), and operating low supply voltage ($V^+V^- = \pm 2\text{V} \sim$).

The NJM4556A combines many of the features of the popular NJM4558 as well as having the capability of driving 150Ω loads. In addition, the wide band-width, low noise, high slew rate and low distortion of the NJM4556A make it ideal for many audio, telecommunications and instrumentation applications.

■ FEATURES

- Supply Voltage ($\pm 2\text{V} \sim \pm 18\text{V}$)
- High Output Current ($I_O = 70\text{mA}$)
- Slew Rate ($3\text{V}/\mu\text{s}$ typ.)
- Gain Band Width Product (8MHz typ.)
- Equivalent Input Noise Voltage ($10\text{nV}/\sqrt{\text{Hz}}$ typ.)
- Package Outline DIP8, DMP8, SIP8, SSOP8
- Bipolar Technology

■ PACKAGE OUTLINE

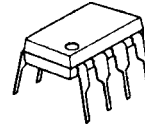

NJM4556AD



NJM4556AM



NJM4556AV

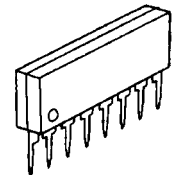

NJM4556AL

■ PIN CONFIGURATION

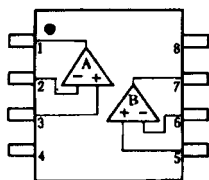

NJM4556AD
NJM4556AM
NJM4556AV

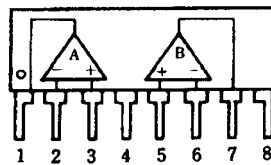

NJM4556AL

- PIN FUNCTION**
- 1. A OUTPUT
 - 2. A -INPUT
 - 3. A +INPUT
 - 4. V^-
 - 5. B +INPUT
 - 6. B -INPUT
 - 7. B OUTPUT
 - 8. V^+

■ EQUIVALENT CIRCUIT (1/2 Shown)

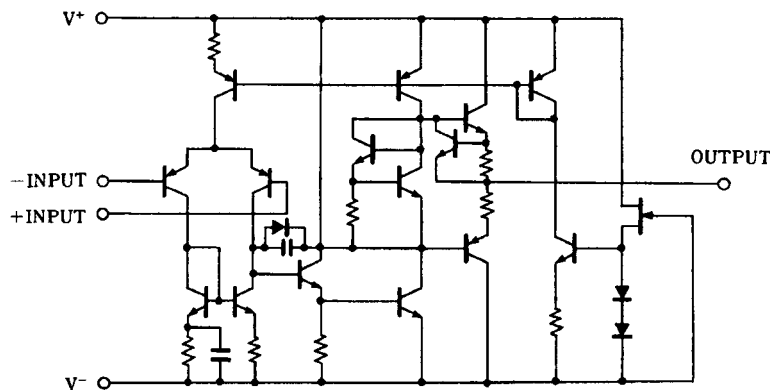

NJM4556A

■ ABSOLUTE MAXIMUM RATINGS

(Ta=25°C)

PARAMETER	SYMBOL	RATINGS	UNIT
Supply Voltage	V ⁺ /V ⁻	± 18	V
Differential Input Voltage	V _{ID}	± 30	V
Input Voltage	V _{IC}	± 15 (note)	V
Power Dissipation	P _D	(DIP8) 700 (DMP8) 300 (SSOP8) 250 (SIP8) 800	mW
Operating Temperature Range	T _{opr}	-40~+85	°C
Storage Temperature Range	T _{stg}	-40~+125	°C

(note) For supply voltage less than ±15V, the absolute maximum input voltage is equal to the supply voltage.

■ ELECTRICAL CHARACTERISTICS (NJM4556AD / NJM4556AL)

(V⁺/V⁻=±15V, Ta=25°C)

PARAMETER	SYMBOL	TEST CONDITION	MIN.	TYP.	MAX.	UNIT
Input Offset Voltage	V _{IO}	R _S ≤10kΩ	-	0.5	6.0	mV
Input Offset Current	I _{IO}		-	5	60	nA
Input Bias Current	I _B		-	50	500	nA
Input Resistance	R _{IN}		0.3	5	-	MΩ
Large Signal Voltage Gain	A _V	R _L ≥2kΩ, V _O =±10V	86	100	-	dB
Maximum Output Voltage Swing 1	V _{OM1}	R _L ≥2kΩ	± 12	± 13.5	-	V
Maximum Output Voltage Swing 2	V _{OM2}	R _L ≥150Ω	± 10.5	± 11	-	V
Input Common Mode Voltage Range	V _{ICM}		± 13.5	± 14	-	V
Common Mode Rejection Ratio	CMR	R _S ≤10kΩ	70	90	-	dB
Supply Voltage Rejection Ratio	SVR	R _S ≤10kΩ	76.5	90	-	dB
Supply Current	I _{CC}		-	9	12	mA
Slew Rate	SR		-	3	-	V/μs
Gain Bandwidth Product	GB		-	8	-	MHz

■ ELECTRICAL CHARACTERISTICS (NJM4556AM / NJM4556AV)

(V⁺/V⁻=±15V, Ta=25°C)

PARAMETER	SYMBOL	TEST CONDITION	MIN.	TYP.	MAX.	UNIT
Input Offset Voltage	V _{IO}	R _S ≤10kΩ	-	0.5	6.0	mV
Input Offset Current	I _{IO}		-	5	60	nA
Input Bias Current	I _B		-	50	500	nA
Large Signal Voltage Gain	A _V	R _L ≥2kΩ, V _O =±10V	86	100	-	dB
Maximum Output Voltage Swing 1	V _{OM1}	V _{IN} ⁺ =4V, V _{IN} ⁻ =3V, V ⁺ =9V, V ⁻ =0V I _{SOURCE} =40mA	7.5	-	-	V
Maximum Output Voltage Swing 2	V _{OM2}	V _{IN} ⁺ =3V, V _{IN} ⁻ =4V, V ⁺ =9V, V ⁻ =0V I _{SINK} =40mA	-	-	2.1	V
Input Common Mode Voltage Range 1	V _{ICM1}	V ⁺ =9V, V ⁻ =0V, V _{IL}	-	-	1.5	V
Input Common Mode Voltage Range 2	V _{ICM2}	V ⁺ =9V, V ⁻ =0V, V _{IH}	8	-	-	V
Common Mode Rejection Ratio	CMR	R _S ≤10kΩ	70	90	-	dB
Supply Voltage Rejection Ratio	SVR	R _S ≤10kΩ	76.5	90	-	dB
Supply Current	I _{CC}	V ⁺ =9V, V ⁻ =0V	-	8	12	mA
Slew Rate	SR		-	3	-	V/μs
Gain Bandwidth Product	GB		-	8	-	MHz

■ TYPICAL CHARACTERISTICS

Maximum Output Voltage Swing vs. Frequency

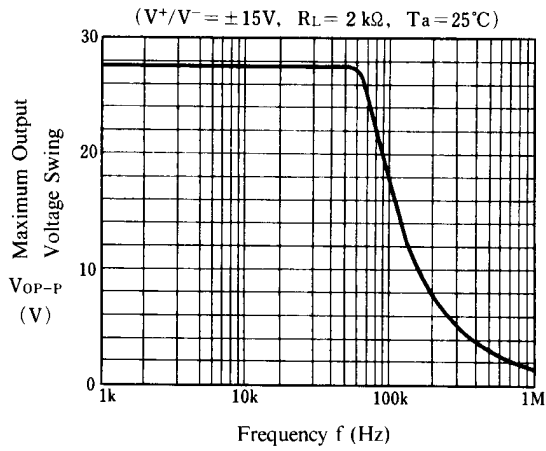

Maximum Output Voltage Swing vs. Frequency

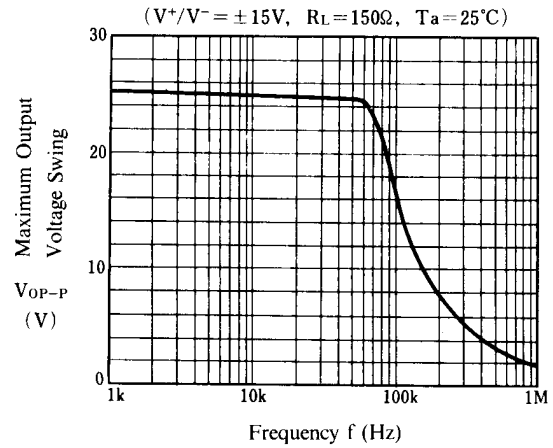

Maximum Output Voltage Swing vs. Output Current

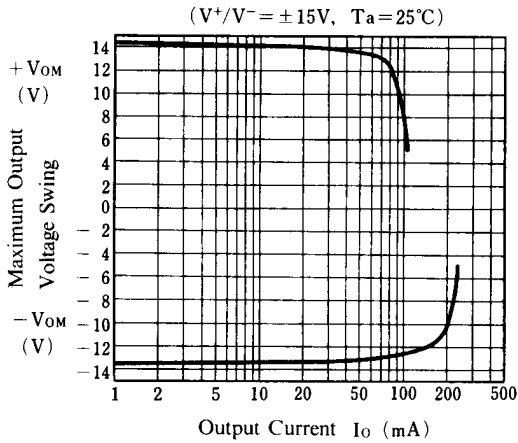

Voltage Gain, Phase Shift vs. Frequency

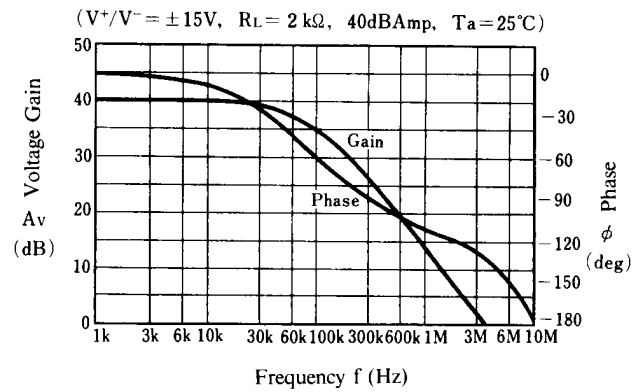

Maximum Output Voltage Swing vs. Supply Voltage

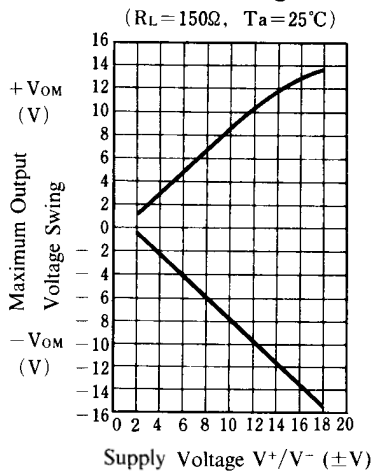

Total Harmonic Distortion vs. Output Voltage

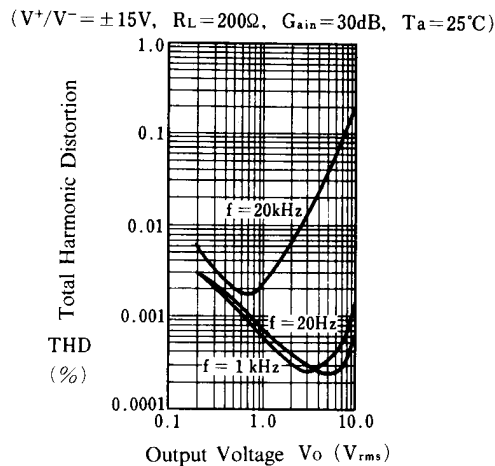

■ TYPICAL CHARACTERISTICS

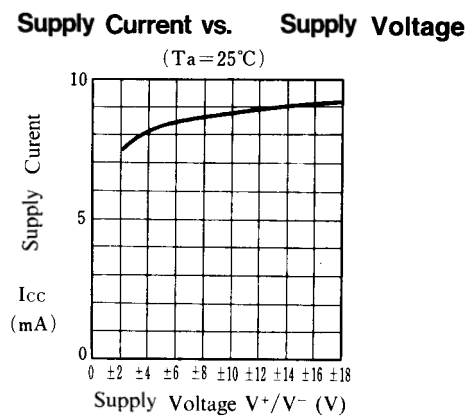
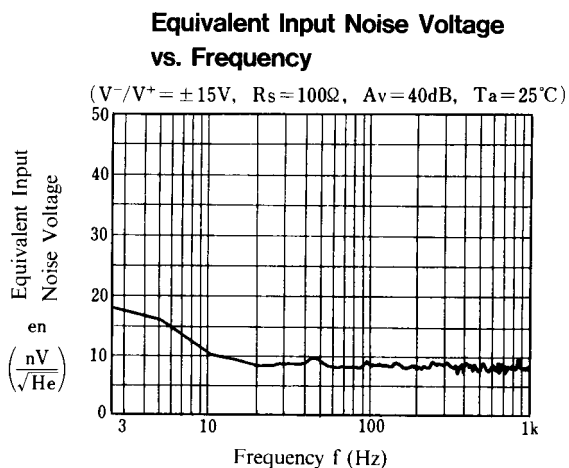
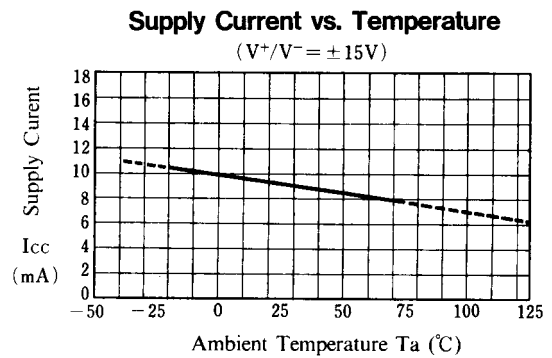
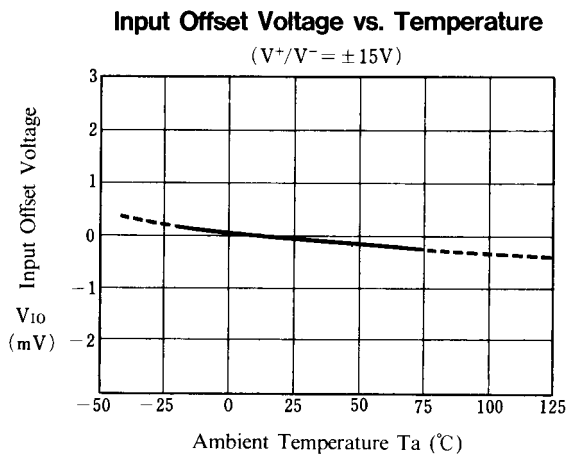
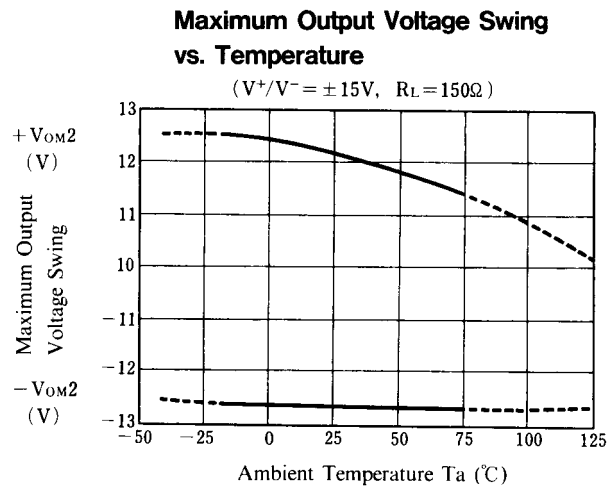
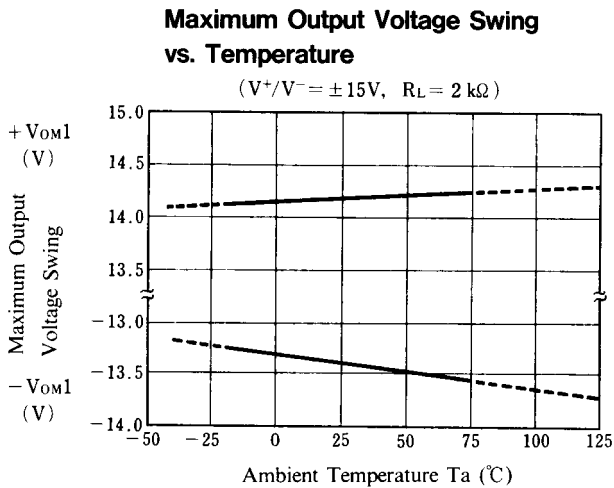

[CAUTION]
The specifications on this databook are only given for information, without any guarantee as regards either mistakes or omissions. The application circuits in this databook are described only to show representative usages of the product and not intended for the guarantee or permission of any right including the industrial rights.

Mouser Electronics

Authorized Distributor

Click to View Pricing, Inventory, Delivery & Lifecycle Information:

[NJR:](#)

[NJM4556AM-TE3](#) [NJM4556AM-TE1](#) [NJM4556AM-TE2](#) [NJM4556AMA-TE2](#) [NJM4556AMA](#) [NJM4556AD](#)
[NJM4556AL](#) [NJM4556AM](#) [NJM4556ADD](#) [NJM4556AV-TE2](#) [NJM4556AV-TE1](#)



Компания «ЭлектроПласт» предлагает заключение долгосрочных отношений при поставках импортных электронных компонентов на взаимовыгодных условиях!

Наши преимущества:

- Оперативные поставки широкого спектра электронных компонентов отечественного и импортного производства напрямую от производителей и с крупнейших мировых складов;
- Поставка более 17-ти миллионов наименований электронных компонентов;
- Поставка сложных, дефицитных, либо снятых с производства позиций;
- Оперативные сроки поставки под заказ (от 5 рабочих дней);
- Экспресс доставка в любую точку России;
- Техническая поддержка проекта, помощь в подборе аналогов, поставка прототипов;
- Система менеджмента качества сертифицирована по Международному стандарту ISO 9001;
- Лицензия ФСБ на осуществление работ с использованием сведений, составляющих государственную тайну;
- Поставка специализированных компонентов (Xilinx, Altera, Analog Devices, Intersil, Interpoint, Microsemi, Aeroflex, Peregrine, Syfer, Eurofarad, Texas Instrument, Miteq, Cobham, E2V, MA-COM, Hittite, Mini-Circuits, General Dynamics и др.);

Помимо этого, одним из направлений компании «ЭлектроПласт» является направление «Источники питания». Мы предлагаем Вам помощь Конструкторского отдела:

- Подбор оптимального решения, техническое обоснование при выборе компонента;
- Подбор аналогов;
- Консультации по применению компонента;
- Поставка образцов и прототипов;
- Техническая поддержка проекта;
- Защита от снятия компонента с производства.



Как с нами связаться

Телефон: 8 (812) 309 58 32 (многоканальный)

Факс: 8 (812) 320-02-42

Электронная почта: org@eplast1.ru

Адрес: 198099, г. Санкт-Петербург, ул. Калинина, дом 2, корпус 4, литера А.