

## General Description

The MAX31790 evaluation kit (EV kit) provides the hardware and software graphical user interface (GUI) necessary to evaluate the MAX31790 6-channel PWM-output fan RPM controller. The EV kit includes a MAX31790ATI+ installed, as well as a USB-to-I<sup>2</sup>C interface.

The USB-to-I<sup>2</sup>C master section on the EV kit labeled "MAXIM DS3900U HID" can be used to interact with the EV kit software and exercise the device's functionality. The EV kit provides headers and test points to connect user-supplied fans, but does not come with a fan included.

## EV Kit Contents

- Assembled circuit board including the MAX31790ATI+ and USB-to-I<sup>2</sup>C circuitry
- Mini-USB cable

## Features

- Easy Evaluation of the MAX31790
- USB HID interface
- Windows XP®, Windows Vista®, and Windows® 7-Compatible Software
- RoHS Compliant
- Proven PCB Layout
- Fully Assembled and Tested

*Ordering Information appears at end of data sheet.*

## EV Kit Photo

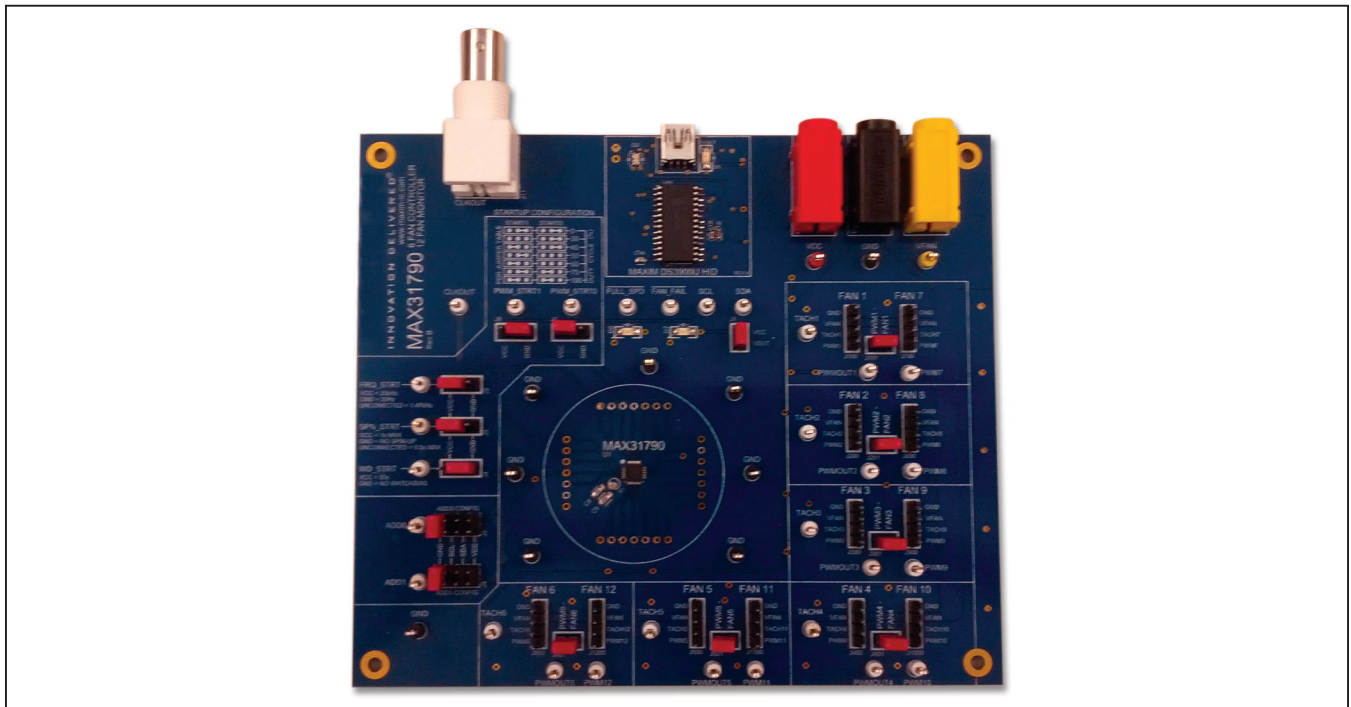

*Windows, Windows XP, and Windows Vista are registered trademarks and registered service marks of Microsoft Corporation.*

## Component List

DESIGNATION	QTY	DESCRIPTION
B1	1	Green banana jack Deltron 571-0500
B2	1	Black banana jack Deltron 571-0100
B3	1	Yellow banana jack Deltron 571-0700
C1	1	0.1 $\mu$ F $\pm$ 10%, 100V X7R ceramic capacitor (0805) TDK CGA4J2X7R2A104K
C1I, C6I, C7I, C11I, C13I	5	0.1 $\mu$ F $\pm$ 10%, 25V X7R ceramic capacitors (0603) TDK C1608X7R1E104K
C2I, C5I	2	4.7 $\mu$ F $\pm$ 10%, 6.3V X5R ceramic capacitors (0603) TDK C1608X5R0J475K
C3	1	4.7 $\mu$ F $\pm$ 10%, 50V X5R ceramic capacitor (0805) TDK CGA4J3X5R1H475K
C3I, C9I, C10I, C12I	4	1.0 $\mu$ F $\pm$ 10%, 16V X7R ceramic capacitors (0603) Murata GRM188R71C105K
C4	1	6.8 $\mu$ F $\pm$ 20%, 50V tantalum capacitor (2812) Vishay 595D685X0050C2T
C4I, C8I	2	0.01 $\mu$ F $\pm$ 10%, 50V ceramic capacitors (0603) Murata GRM188R71H103K
C8, C9	2	12pF $\pm$ 05%, 100V ceramic capacitors (0805) AVX 08051A120JAT2A
C14I	1	220nF $\pm$ 10%, 10V X7R ceramic capacitor (0603) TDK C1608X7R1A224K
D1I	1	Red LED (1206) Knightbright APTR3216EC
D2I	1	Dual LED (0805) Kingbright APHBM2012SURKCGKC
D3I	1	Schottky diode (MINI2-F1) Panasonic-SSG DB2W31900L
D7, D8	2	Red LEDs (1206) Knightbright APTR3216EC

DESIGNATION	QTY	DESCRIPTION
J1, J101, J201, J301, J401, J501, J601	7	2-pin headers, 2.54mm pitch 3M 961102-6404-AR
J1I	1	USB_ 5-pin female header Molex 54819-0519
J2–J4, J7, J8	5	3-pin headers, 2.54mm pitch 3M 961103-6404-AR
J2I, J3I	2	Solder bridges
J5, J6	2	8-pin (2 x 4) headers, 2.54mm pitch 3M 961208-6404-AR
J1I	1	5-pin BNC TE connector AMP 5227161-1
J100, J200, J300, J400, J500, J600, J700, J800, J900, J1000, J1100, J1200	12	4-pin headers, 2.54mm pitch 3M 961104-6404-AR
Q1I	1	nMOS (SOT323) ON Semi NTS4001NT1G
R1–R4, R101, R103, R201, R203, R301, R303, R401, R403, R501, R503, R601, R603	16	4.7k $\Omega$ $\pm$ 1% resistors (0805) Vishay CRCW08054K70FKEA
R1I, R7I, R8I	3	330 $\Omega$ $\pm$ 1% resistors (0603) Vishay CRCW0603330RFKEA
R2I, R3I	2	24.9 $\Omega$ $\pm$ 1% resistors (0603) Vishay CRCW060324R9FKEA
R4I	1	100k $\Omega$ $\pm$ 1% resistor (0603) Vishay CRCW0603100KFKEA
R5, R6	2	1.21k $\Omega$ $\pm$ 1% resistors (0805) Vishay CRCW08051K20FKEA
R5I, R6I	2	10k $\Omega$ $\pm$ 1% resistors (0603) Vishay CRCW060310K0FKEA

**Component List (continued)**

DESIGNATION	QTY	DESCRIPTION
R7–R10, R100, R200, R300, R400, R500, R600	10	0Ω ±1% resistors (0805) Vishay CRCW0805000RFKEA
R9I	1	2.2kΩ ±1% resistor (0603) Vishay CRCW06032K20FKEA
R10I	1	4.7kΩ ±1% resistor (0603) Vishay CRCW06034K70FKEA
R11	1	100Ω ±10% resistor (0805) Vishay CRCW0805100RFKEA
TP1–TP5, TP22–TP28, TP40–TP57	30	White test points Keystone 5012
TP6–TP8, TP30–TP35	9	Black test points Keystone 5011
TP29	1	Red test point Keystone 5010
TP37	1	Yellow test point Keystone 5014

DESIGNATION	QTY	DESCRIPTION
U1	1	Fan controller (28 TQFN-EP*) Maxim MAX31790ATI+
U1I	1	Current-limit switch (5 SOT70) Maxim MAX4787EXK+
U2I	1	Linear regulator (5 SOT23) Maxim MAX8868EUK33+
U3I	1	USB transceiver (16 TSSOP) Maxim MAX3344EEUE+
U4I	1	FXMA108 Fairchild FXMA108BQX
U5I	1	PIC Microchip PIC18LF2550-I/SO
X1	1	12pF crystal Epson C-002SH 32.7680KA-A
X1I	1	4-pin CMOS oscillator AVX KC3225A48.0000C30E00
—	1	PCB: MAX31790 6 FAN CONTROLLER, 12 FAN MONITOR

\*EP = Exposed pad.

**MAX31790 EV Kit Files**

FILE	DESCRIPTION
MAX31790EVKitSoftware.EXE	Application program

**Note:** The .EXE file is downloaded as a .ZIP file.

**Quick Start**

**Required Equipment**

- MAX31790 EV kit
- User-supplied Windows XP, Windows Vista, or Windows 7 PC with USB port
- Mini-USB cable (included)
- EV kit hardware (included)
- User-supplied 3.3V power supply (300mA minimum)
- User-supplied 12V VFAN power supply
- User-supplied DC fan

**Note:** In the following sections, software-related items are identified by bolding. Text in **bold** refers to items directly from the EV kit software. Text in **bold and underlined** refers to items from the Windows operating system.

**Setup Procedure**

The EV kit is fully assembled and tested. Follow the steps below to verify board operation:

- 1) Place the EV kit hardware on a nonconductive surface to ensure that nothing on the PCB gets shorted to the workspace.
- 2) Ensure that jumper/shunt J1 is installed, which provides power to the device.
- 3) Check the following startup configuration jumpers/shunts, which result in the associated behavior:
  - a. J8 (PWM\_START1) = GND and J7 (PWM\_START0) = VCC. Defines a power-on-reset (POR) PWM duty cycle of 75%.
  - b. J2 (FREQ\_START) = VCC. Defines a POR PWM frequency of 25kHz.
  - c. J3 (SPIN\_START) = VCC. Defines the POR spin-up behavior for 100% duty cycle until two tachometer pulses or 1s (MAX).
  - d. J4 (WATCHDOG\_START) = GND. Defines a disabled I<sup>2</sup>C watchdog on POR.
  - e. J5 (ADD0) = GND and J6 (ADD1) = GND. Defines a POR slave address of 40h.

- 4) Ensure that jumpers/shunts J101, J201, J301, J401, J501, and J601 are installed, which connects the associated PWMOUT signal to the Fan1–Fan6 headers.
- 5) Connect a 3.3V power supply to the VCC and GND banana jacks.
- 6) Connect a 12V power supply to the VFAN and GND banana jacks.
- 7) Prior to starting the GUI, connect the EV kit hardware to a PC using the supplied mini-USB cable, or equivalent. The COM LED (D2I) should be red and slowly flash orange.
- 8) Windows should automatically begin installing the necessary device driver. The USB interface of the EV kit hardware is configured as an HID device and therefore does not require a unique/custom device driver. Once the driver installation is complete, a Windows message appears near the System Icon menu indicating that the hardware is ready to use. Do not attempt to run the GUI prior to this message. If you do, then you must close the application and restart it once the driver installation is complete. On some versions of Windows, administrator privileges may be required to install the USB device.
- 9) Once the device driver installation is complete, visit [www.maximintegrated.com/evkitsoftware](http://www.maximintegrated.com/evkitsoftware) to download the latest version of the EV kit software, MAX31790EVKitSoftware.zip. Save the EV kit software to a temporary folder.
- 10) Open the .ZIP file and extract the .EXE file to your desired location. The .EXE file is the actual EV kit GUI and not an install program. You can store the .EXE wherever you like and then uninstall it later by simply deleting the .EXE file.
- 11) Double-click on the .EXE file to run the GUI. A message box stating **The publisher could not be verified. Are you sure you want to run this software?** may appear. If so, click **Run**.
- 12) When the GUI appears, proper communication to the USB-to-I<sup>2</sup>C master is indicated in the lower right corner below the **Status** box by a text string stating **DS3900 Connected**. The COM LED (D2I) now turns off and flashes red when communication occurs.
- 13) To verify communication to the device, with the default jumper/shunt settings described in steps 2–4, press the **UpdateDashboard** button on the top right corner and verify the **PWM Frequency** updates to 25kHz and all **Duty Cycle values** update to 75.15%, as shown in Figure 1. This completes the EV kit setup. The hardware and software are ready to begin evaluating the device. If any issues arise, see the *Troubleshooting* section.

## Detailed Description of Software

### GUI Status Box

On the bottom right side of the GUI is the **Status** group box. It is used to relay information to the user and is cleared with the associated **Clear** Button. The text box below the **Status** label indicates the status of the communication between the GUI and the EV kit hardware. If everything is working properly, a message indicates **DS3900 Connected**; otherwise, the display shows a yield sign and **DS3900 Disconnected!!**

### Device Configuration

Upon successful completion of the setup procedure, the user is ready to begin evaluation of the device. The device's POR behavior is set by the power-up configuration pins and the default POR values, as defined in the MAX31790 IC data sheet. The USB-to-I<sup>2</sup>C master communicates to the **Slave ID (hex)** shown in the **DashBoard** in the upper right side of the GUI. To change the target slave address, enter the new value into the input field and press the **Set** button.

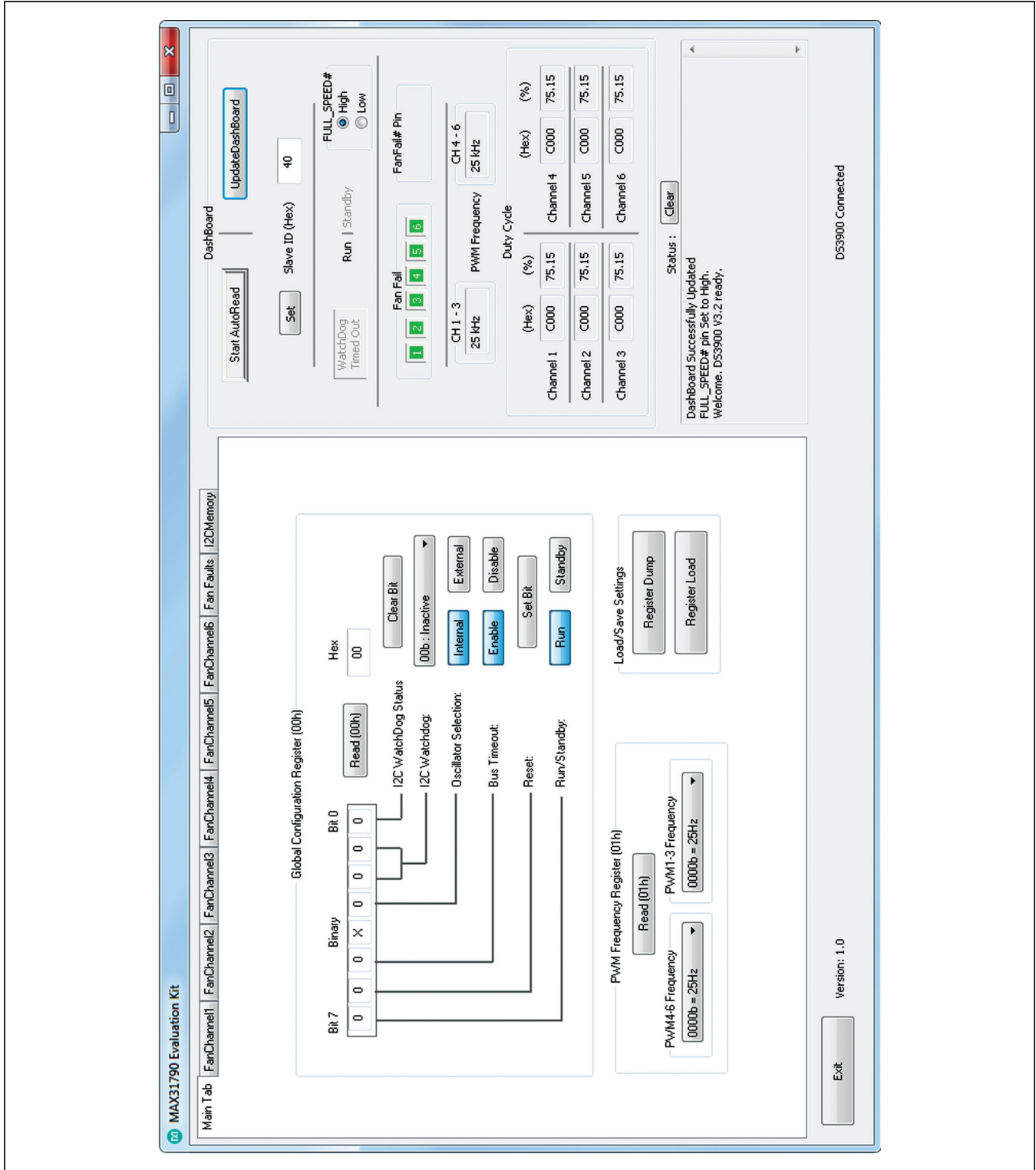

Figure 1. MAX31790 EV Kit GUI (Main Tab)

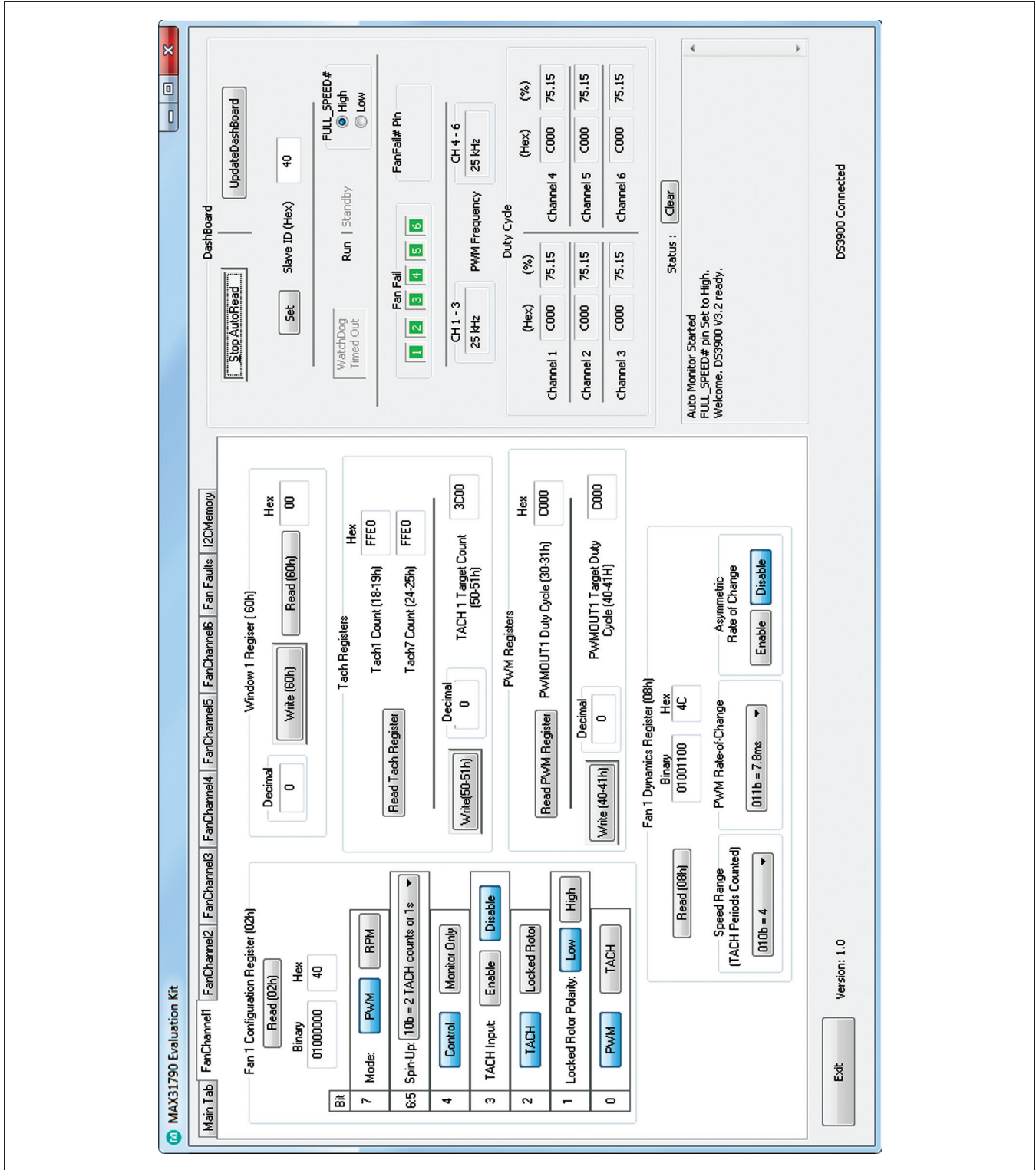

Figure 2. MAX31790 EV Kit GUI (FanChannel1 Tab)

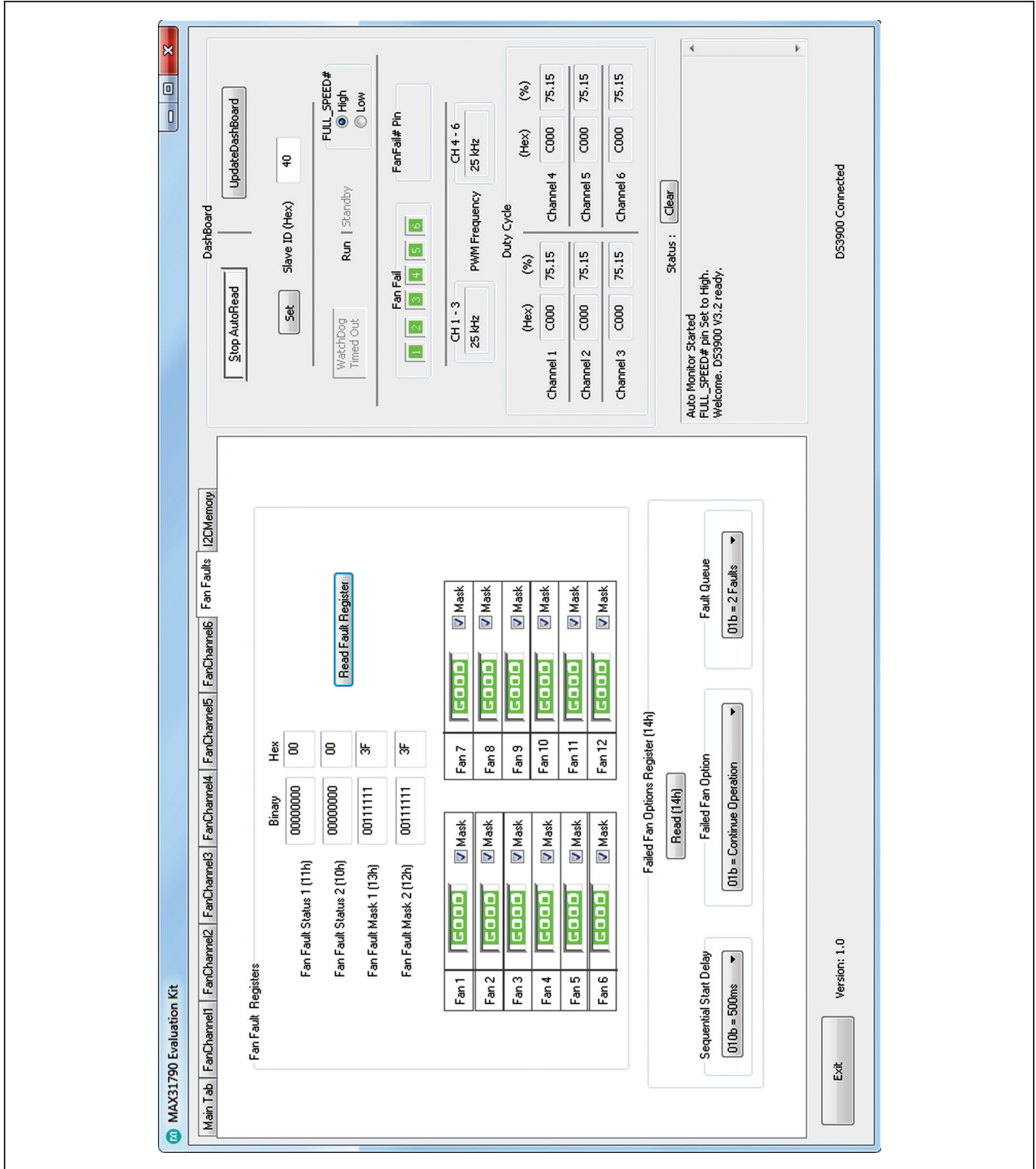

Figure 3. MAX31790 EV Kit GUI (Fan Faults Tab)

**Reads**

Each register of the device can be read from the GUI by the simple press of the associated **Read** button. The registers are located in one of the tabs as defined below:

- **Main Tab** (Figure 1):
  - Global Configuration register
  - PWM Frequency register
- **FanChannel1–6 Tabs** (Figure 2):
  - Fan n Configuration register (where n denotes the channel)
  - Fan n Dynamics register
  - Tach n Count register
  - PWMOUt n Duty Cycle register
  - PWMOUt n Target Duty Cycle register
  - TACH n Target Duty Cycle register
  - Window n Register
- **Fan Faults Tab** (Figure 3):
  - Fan Fault Status 1 register

- Fan Fault Status 2 register
- Fan Fault Mask 1 register
- Fan Fault Mask 2 register
- Failed Fan Options/Sequential Start register

Pressing a **Read** button performs a single read of the register(s) and updates the associated data fields. There is also an option to do continuous reads of the device. This **AutoRead** feature is located in the upper right section of the GUI. To start polling at a 1Hz frequency, press the **Start AutoRead** button. Each poll reads all registers shown in the dashboard and the active tab then updates the associated data fields. Once the continuous reads start, the button text changes to **Stop AutoRead** for the user to stop the reads. It is not recommended to change register parameters through a write while **AutoRead** is enabled.

The GUI provides a very simple way to dump all the device registers to a text (.TXT) file. Under the **Main Tab** sheet, press the **Register Dump** button and provide a folder and file name. An example of a Register Dump is shown in Figure 4.

```

;MAX31790 Register Dump 11/13/2012 7:49:17
; ';' (semicolon) is used for commenting
;All Registers are read and stored in the 2 Columns below
;Register| Value
; (hex) | (hex)
;-----|-----
0x00 | 0x20
;-----|-----
0x01 | 0xBB
;-----|-----
0x02 | 0x40
;-----|-----
0x03 | 0x40
;-----|-----
0x04 | 0x40
;-----|-----
0x05 | 0x40
;-----|-----
0x06 | 0x40
;-----|-----
0x07 | 0x40
;-----|-----
0x08 | 0x4C
;-----|-----
0x09 | 0x4C
    
```

Figure 4. MAX31790 Data Table



## Writes

Each register of the device can be written to/from the GUI either by the simple click on the radio button or the input of a decimal value followed by a press of the associated **Write** button. The writable registers are located in one of the tabs, as defined in the previous *Reads* section.

Clicking on any radio button or drop-down list automatically writes the selected value to the device. To verify a successful write, perform a read that then updates the field. To write a register that requires a numerical value, such as **TACH n Target Count** or **PWMOUT n Target Duty**, enter the decimal value desired for the non-reserved data bits of the registers. For example, to write **PWMOUT 1 Target Duty Cycle** to a value of 39%, or 200 decimal (refer to the MAX31790 IC data sheet for bit weighting), click on the **FanChannel1** tab and enter 200 in the input box located to the left of the **PWMOUT 1 Target Duty Cycle(40-41h)** label and press the **Write (40-41h)** button. This writes 64h to register 40h and 00h to register 41h. Verify the write by pressing the **Read PWM Register** button.

The GUI provides a very simple way to load all the device registers from a text (.TXT) file. Under the **Main Tab** sheet, press the **Register Load** button and provide a previously saved **Register Dump** file or a modified version of a previous dump. The register load file must have the same format as the GUI-generated dump file.

## General I<sup>2</sup>C Tab

The GUI provides a generic I<sup>2</sup>C tab (**I2CMemory**), which is not required to evaluate the device. Use this tab if a more flexible I<sup>2</sup>C transaction is required.

### FULL\_SPEED Input Signal Control

The GUI provides a method to control the FULL\_SPEED input to the device. On the right side of the GUI in the **DashBoard** group box, there is a **FULL\_SPEED#** section with two radio buttons that toggles the logic level of this signal between high and low.

### FAN\_FAIL Output Signal Monitor

The GUI provides a method to monitor the FAN\_FAIL output of the device. In the **DashBoard** group box, there is a **FAN\_FAIL# Pin** section that changes to reflect the logic level of this signal.

## Detailed Description of Hardware

### User-Supplied Fans

The MAX31790 EV kit provides the flexibility to control the speeds of up to six fans or monitor up to 12 fans. The EV kit contains 12 fan headers (100 mil spacing) that fans connect to. Refer to the MAX31790 IC data sheet for various examples of fan configurations. Connect fans to the correct GND, VFAN, TACH, and PWM headers. In a closed-loop fan-control configuration on FAN1–FAN6, the jumper/shunt PWMn/FANn (J101, J201, J301, J401, J501, and J601) must be populated. This connects the PWM signal from the device to the fan header. To use PWM outputs as tachometer inputs, open-loop monitor configuration, on fan channel 1 for example, remove the jumper/shunt on PWM1/Fan1 (J101) and attach a fan to the Fan1/Fan7 headers. Connect the desired PWM signal for Fan1 to the PWM1 header and connect the desired PWM signal for Fan7 to the PWM7 test point. Properly configure the device through the I<sup>2</sup>C port to reflect the hardware configuration.

### User-Supplied I<sup>2</sup>C interface

The USB-to-I<sup>2</sup>C master section of the EV kit is not necessary for the proper operation of the device. If the user wants to supply the I<sup>2</sup>C interface, the USB-to-I<sup>2</sup>C master section of the EV kit can be disconnected by removing resistors R7 and R8. Connect test points SDA, SCL, and GND. The FULL\_SPEED and FAN\_FAIL signals from the device can also be routed to a different master by removing resistors R9 and R10 and connecting to the FULL\_SPD, FAN\_FAIL, and GND test points.

### Change Startup Configuration Jumpers

All the startup configuration jumpers (J2–J8) are located on the left side of the PCB and partitioned off by silk-screen labeled STARTUP CONFIGURATION. Refer to the MAX31790 IC data sheet for resulting device operation. After changing jumper configurations, a device POR or a setting of the Reset bit in the Global Configuration register is required for new configurations to take effect.

**Table 1. Hardware Configurations**

HARDWARE ACTION	COMPONENTS	DESCRIPTION
Connect user-supplied Fan1–Fan6	J100, J200, J300, J400, J500, J600,	Connect a user-supplied fan to the correct GND, VFAN, TACH, and PWM headers.
Connect user-supplied Fan7–Fan12	J700, J800, J900, J1000, J1100, J1200	Connect a user-supplied fan to the correct GND, VFAN, TACH, and PWM headers.
Connect $\overline{\text{FULL\_SPEED}}$ and $\overline{\text{FAN\_FAIL}}$ pins to user-supplied interface	R9, R10	Remove resistors R9 and R10 and connect to the $\overline{\text{FULL\_SPD}}$ and $\overline{\text{FAN\_FAIL}}$ test points.
Connect user-supplied I <sup>2</sup> C interface	R7, R8	Remove resistors R7 and R8 and connect to user-supplied I <sup>2</sup> C interface to test points.
Change startup configuration jumpers	J2–J8	Adjust the jumper/shunt positions according to the silkscreen labels.

**Table 2. Description of LEDs**

LED	COLOR	DESCRIPTION
D1I (FAULT)	Red	<b>USB Power Fault:</b> A fault occurred due to overvoltage limit, current limit, or thermal limit.
D2I (COM)	Red	<b>Communication:</b> After the software has initialized the hardware, the LED flashes red when a command from the PC is received.
	Off	<b>Initialized:</b> Hardware has been initialized by software.
	Red and Flashing Orange	<b>Waiting:</b> Hardware is powered on and waiting for the software to be opened.
D6	Red	<b>FULL_SPEED:</b> LED connected to the active-low $\overline{\text{FULL\_SPEED}}$ input. LED turns red when the $\overline{\text{FULL\_SPEED}}$ signal is logic-low.
D7	Red	<b>FAN_FAIL:</b> LED connected to the active-low open-drain $\overline{\text{FAN\_FAIL}}$ output. LED turns red when the $\overline{\text{FAN\_FAIL}}$ signal is logic-low.

### Troubleshooting

All efforts were made to ensure that each EV kit works on the first try, right out-of-the-box. In the rare occasion that a problem is suspected, see Table 3 to help troubleshoot the issue.

**Table 3. Troubleshooting**

SYMPTOM	CHECK	SOLUTION
GUI indicates: <b>Hardware not found</b>	Is the LED labeled D1I red?	If yes, then the electronic fuse is in a fault state. Inspect for electrical shorts on the PCB and make sure that the PCB is not sitting on a conductive surface.
	Does the LED labeled D2I turn off when the GUI is running?	If not, then exit the GUI and try running it again. If D2I still does not turn off, then exit the GUI and power cycle the board by removing and reapplying the user-supplied power source. Try connecting the USB cable to a different USB port on the PC and wait for a Windows message that states that the hardware is ready to use. Run the GUI again. If D2I still does not turn off, unplug the USB cable and reboot the PC. Connect the USB cable and open the GUI.
	Are any of the LEDs illuminated?	If not, then the PCB may not be getting power from the user-supplied power supply. Verify the power-supply bias with a voltmeter, measuring from VCC to GND. Valid levels are 3V to 5.5V.
GUI <b>Status</b> indicates: <b>Error communicating with the MAX31790</b>	Slave address jumper configuration (J5, J6)	Check the current setting of the slave address jumper configurations (J5, J6) and input the resulting slave address in the <b>Slave ID (Hex)</b> input box, then pressing the <b>Set</b> button.



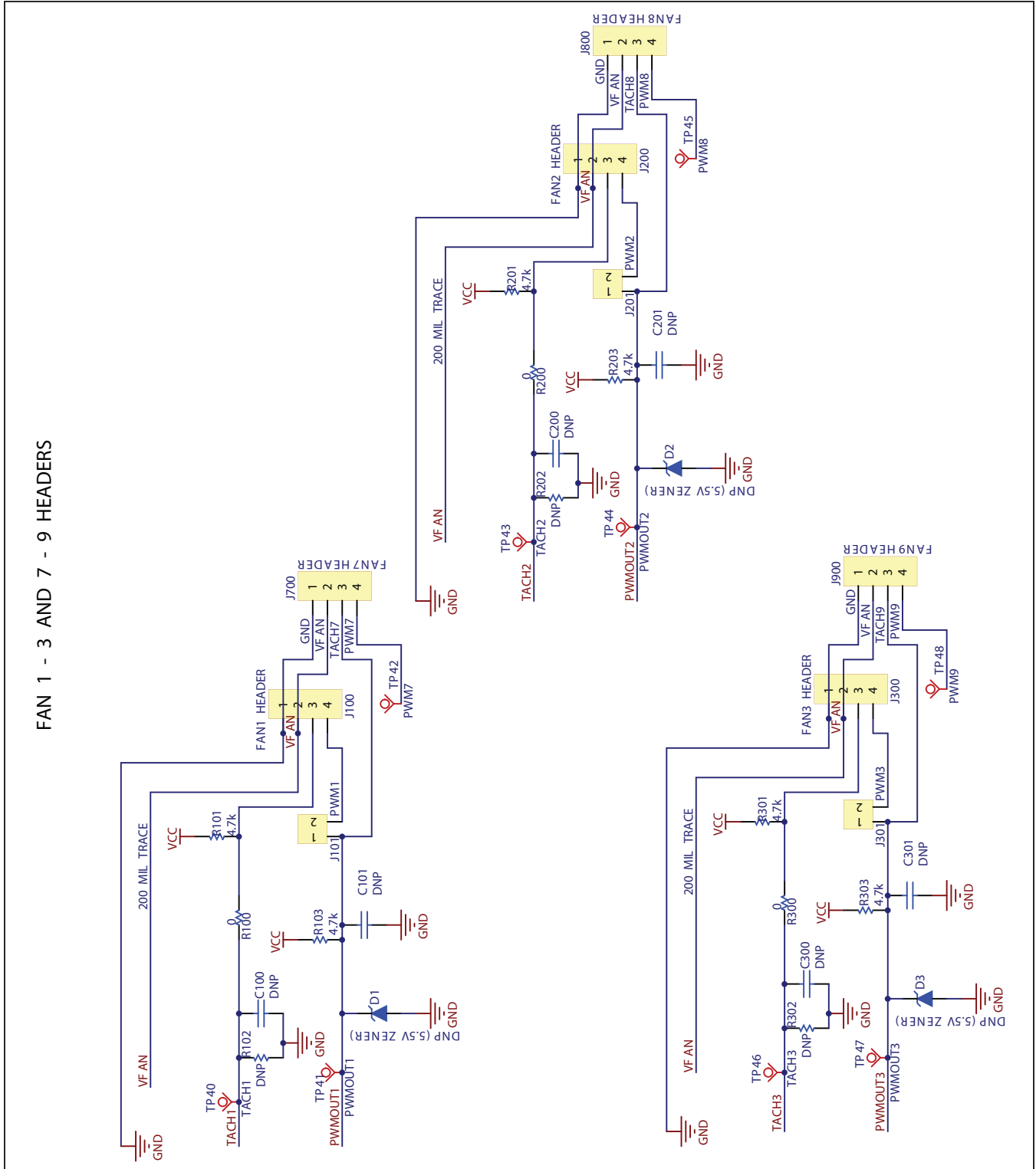

Figure 5b. MAX31790 EV Kit Schematic (Sheet 2 of 4)



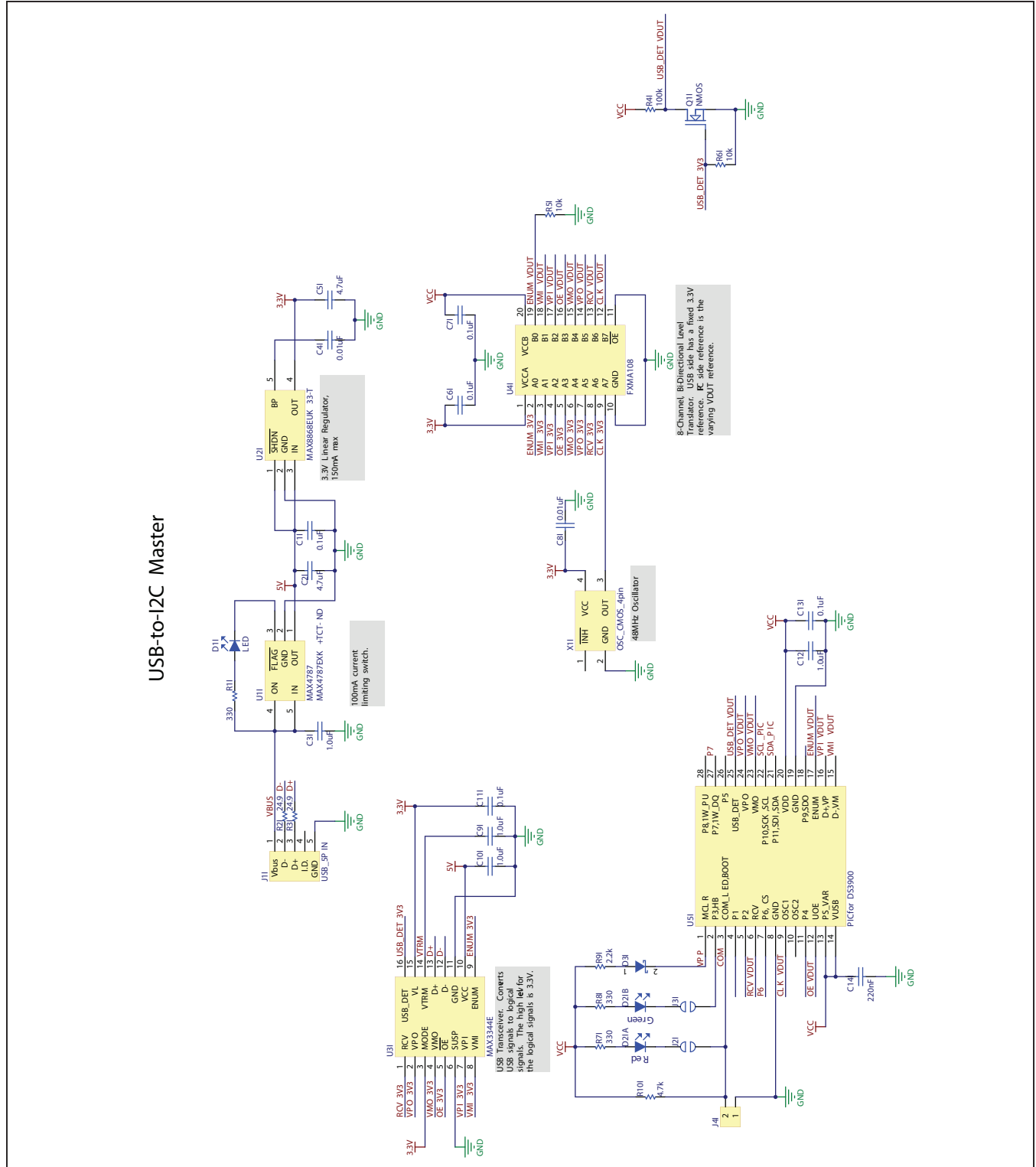
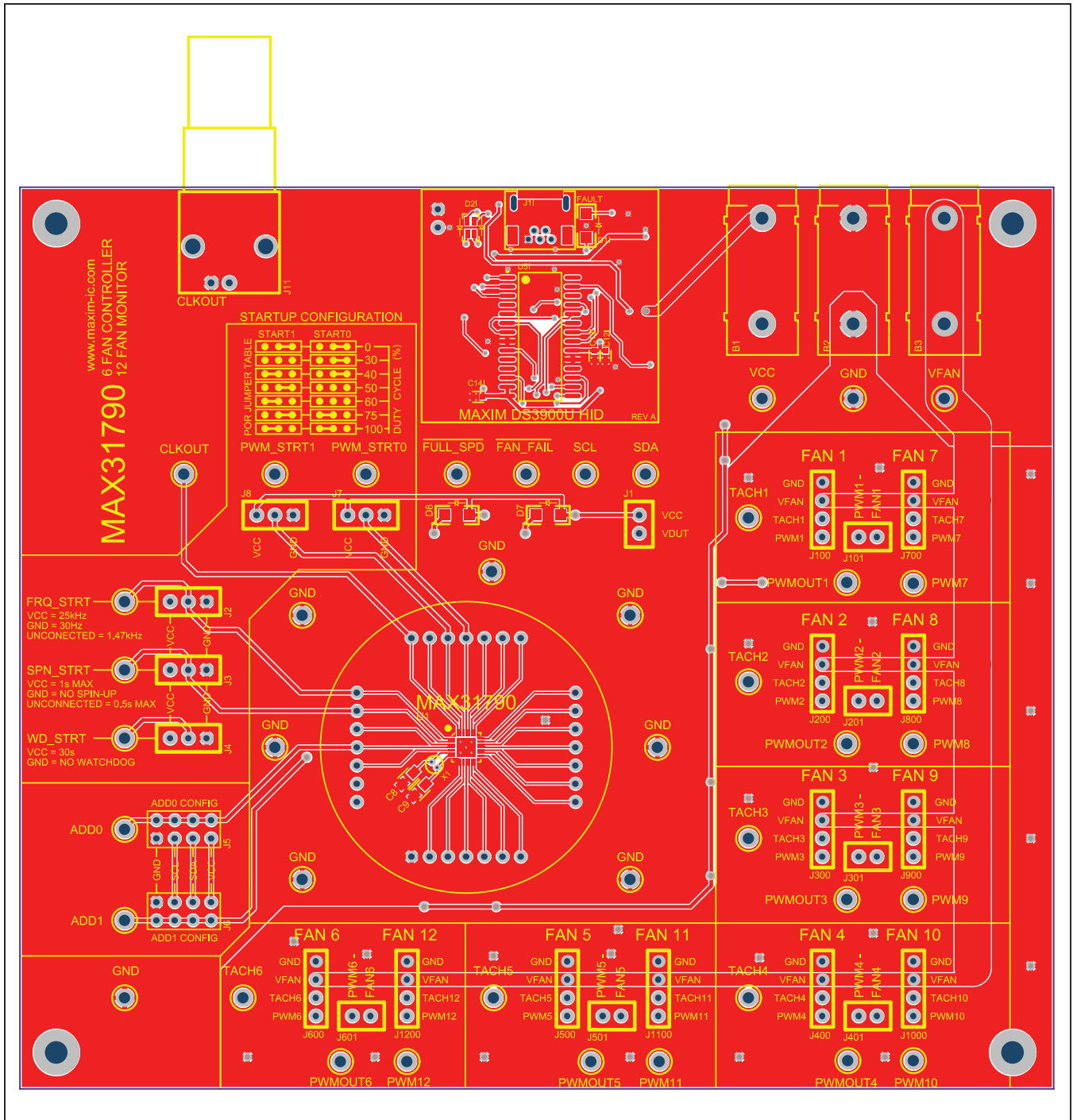

Figure 5d. MAX31790 EV Kit Schematic (Sheet 4 of 4)





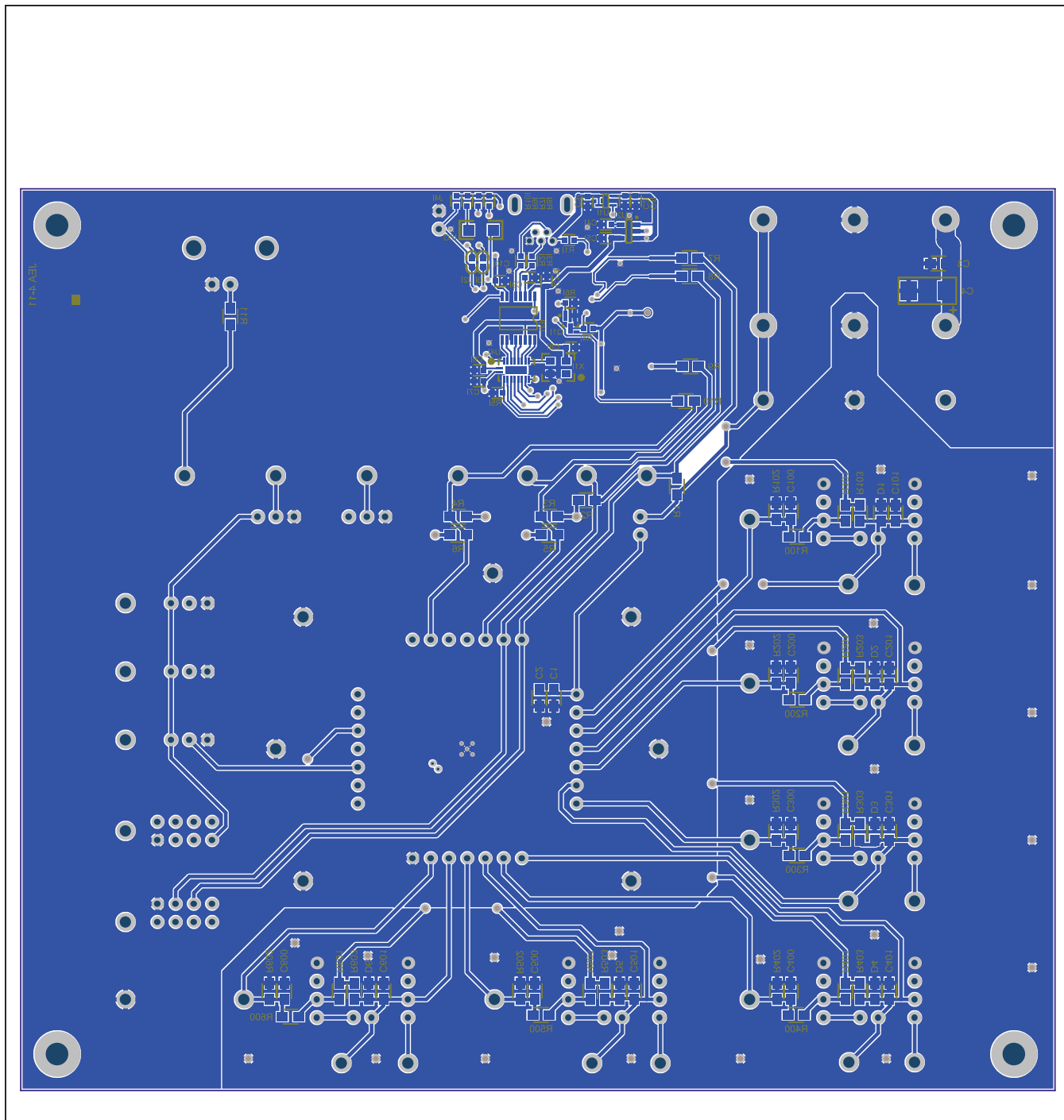

Figure 7. MAX31790 EV Kit PCB Layout—Bottom

### Ordering Information

PART	TYPE
MAX31790EVKIT#	EV Kit

*#Denotes an RoHS-compliant device that may include lead(Pb), which is exempt under the RoHS requirements.*

### Revision History

REVISION NUMBER	REVISION DATE	DESCRIPTION	PAGES CHANGED
0	1/13	Initial release	—

For pricing, delivery, and ordering information, please contact Maxim Direct at 1-888-629-4642, or visit Maxim Integrated's website at [www.maximintegrated.com](http://www.maximintegrated.com).

*Maxim Integrated cannot assume responsibility for use of any circuitry other than circuitry entirely embodied in a Maxim Integrated product. No circuit patent licenses are implied. Maxim Integrated reserves the right to change the circuitry and specifications without notice at any time.*



Компания «ЭлектроПласт» предлагает заключение долгосрочных отношений при поставках импортных электронных компонентов на взаимовыгодных условиях!

Наши преимущества:

- Оперативные поставки широкого спектра электронных компонентов отечественного и импортного производства напрямую от производителей и с крупнейших мировых складов;
- Поставка более 17-ти миллионов наименований электронных компонентов;
- Поставка сложных, дефицитных, либо снятых с производства позиций;
- Оперативные сроки поставки под заказ (от 5 рабочих дней);
- Экспресс доставка в любую точку России;
- Техническая поддержка проекта, помощь в подборе аналогов, поставка прототипов;
- Система менеджмента качества сертифицирована по Международному стандарту ISO 9001;
- Лицензия ФСБ на осуществление работ с использованием сведений, составляющих государственную тайну;
- Поставка специализированных компонентов (Xilinx, Altera, Analog Devices, Intersil, Interpoint, Microsemi, Aeroflex, Peregrine, Syfer, Eurofarad, Texas Instrument, Miteq, Cobham, E2V, MA-COM, Hittite, Mini-Circuits, General Dynamics и др.);

Помимо этого, одним из направлений компании «ЭлектроПласт» является направление «Источники питания». Мы предлагаем Вам помощь Конструкторского отдела:

- Подбор оптимального решения, техническое обоснование при выборе компонента;
- Подбор аналогов;
- Консультации по применению компонента;
- Поставка образцов и прототипов;
- Техническая поддержка проекта;
- Защита от снятия компонента с производства.



#### Как с нами связаться

**Телефон:** 8 (812) 309 58 32 (многоканальный)

**Факс:** 8 (812) 320-02-42

**Электронная почта:** [org@eplast1.ru](mailto:org@eplast1.ru)

**Адрес:** 198099, г. Санкт-Петербург, ул. Калинина, дом 2, корпус 4, литера А.