

LOC	DIST	REVISIONS					
IR	-	P	LTR	DESCRIPTION	DATE	DWN	APVD
			E3	ECR-10-026537	27JUN11	KK	HMR

- NOTE:
- 1 MATERIAL :  
HOUSING : NYLON 66 OR EQUIVALENT, UL94V-0, BLACK COLOUR.  
CONTACT : COPPER ALLOY
  - 2 FINISH:  
CONTACT : GOLD PLATED (SEE TABLE) ON CONTACT AREA  
80µ" MIN. TIN PLATED ON SOLDER TAIL,  
50µ" MIN. NICKEL UNDERPLATED ALL OVER.
3. APPLICATION :  
SOLDERTAIL LENGTH 2.6 FOR PCB THICKNESS 1.6±0.1  
1.2 FOR PCB THICKNESS 0.3 MAX.
4. KEYING POS. : HOUSING CAVITY MOLDED SHUT
5. QUALIFICATION TEST REPORT: 501-57197

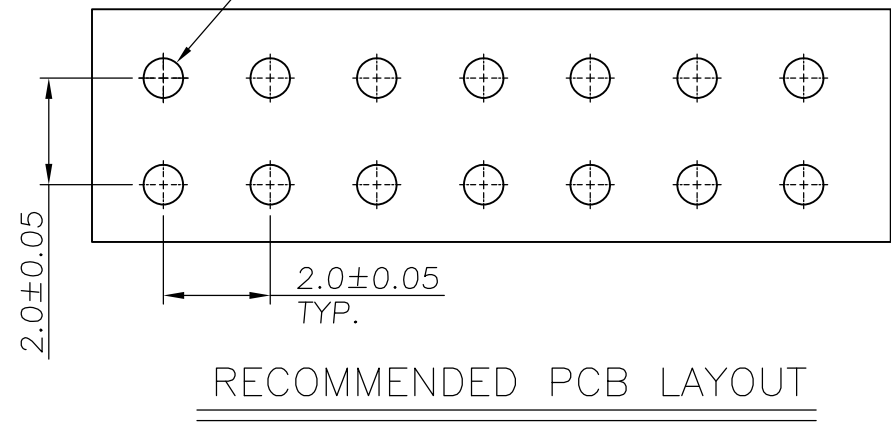
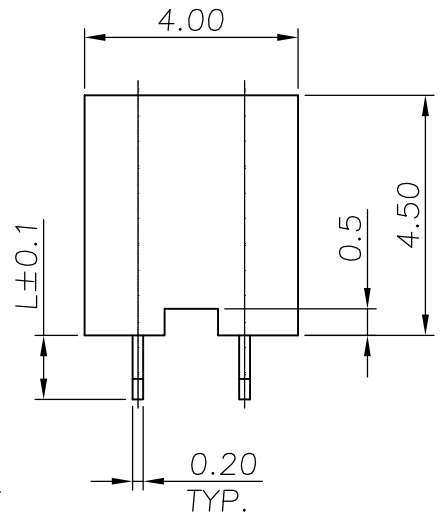
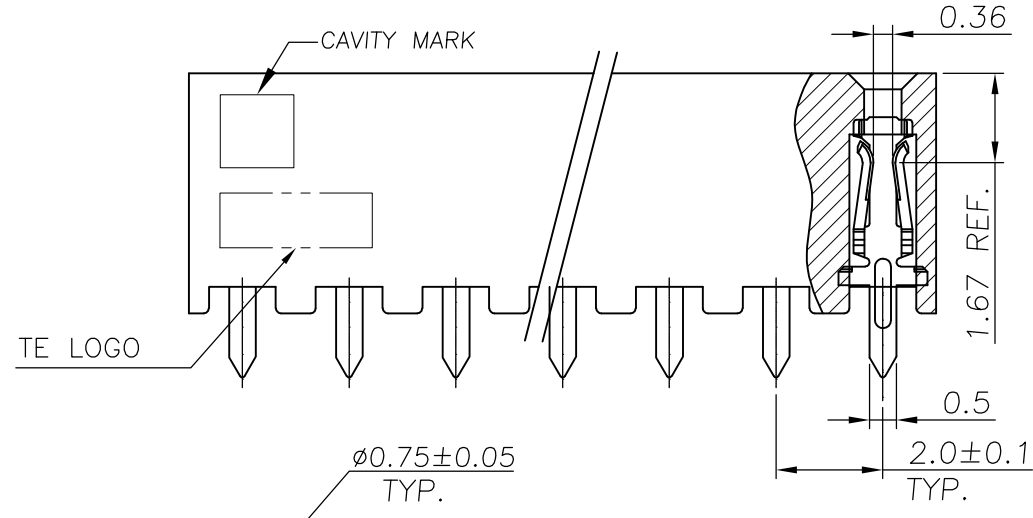
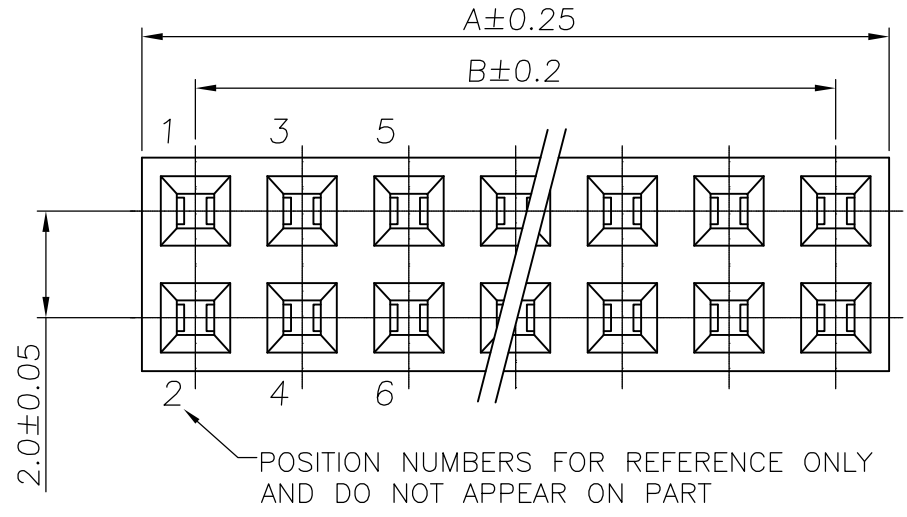
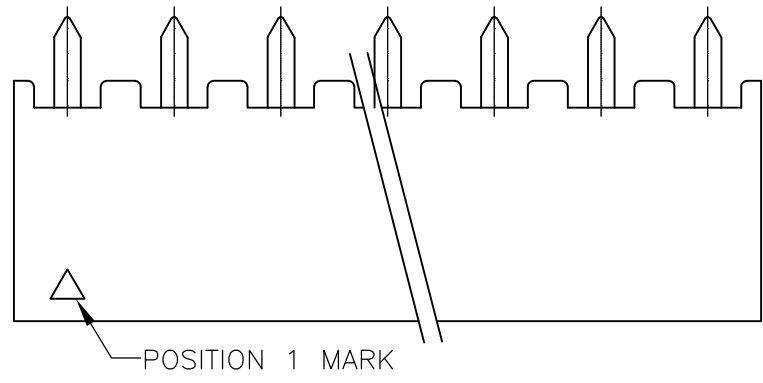

OBsolete	6	40	38	40	9	-9	OBsolete	6	40	38	40	4	-9
OBsolete		50	48	50	9	-8			50	48	50	4	-8
OBsolete		48	46	48	9	-7			48	46	48	4	-7
OBsolete		46	44	46	9	-6			46	44	46	4	-6
OBsolete		44	42	44	9	-5			44	42	44	4	-5
OBsolete		42	40	42	9	-4			42	40	42	4	-4
OBsolete		40	38	40	9	-3			40	38	40	4	-3
OBsolete		38	36	38	9	-2			38	36	38	4	-2
OBsolete		36	34	36	9	-1			36	34	36	4	-1
OBsolete		34	32	34	9	0			34	32	34	4	0
OBsolete		32	30	32	8	-9			32	30	32	3	-9
OBsolete		30	28	30	8	-8			30	28	30	3	-8
OBsolete		28	26	28	8	-7			28	26	28	3	-7
OBsolete		26	24	26	8	-6			26	24	26	3	-6
OBsolete		24	22	24	8	-5			24	22	24	3	-5
OBsolete		22	20	22	8	-4			22	20	22	3	-4
OBsolete		20	18	20	8	-3			20	18	20	3	-3
OBsolete		18	16	18	8	-2			18	16	18	3	-2
OBsolete		16	14	16	8	-1			16	14	16	3	-1
OBsolete		14	12	14	8	0			14	12	14	3	0
OBsolete		12	10	12	7	-9			12	10	12	2	-9
OBsolete		10	8	10	7	-8			10	8	10	2	-8
OBsolete		8	6	8	7	-7			8	6	8	2	-7
OBsolete		6	4	6	7	-6			6	4	6	2	-6
OBsolete		4	2	4	7	-5			4	2	4	2	-5
OBsolete		50	48	50	7	-4			50	48	50	2	-4
OBsolete		48	46	48	7	-3			48	46	48	2	-3
OBsolete		46	44	46	7	-2			46	44	46	2	-2
OBsolete		44	42	44	7	-1			44	42	44	2	-1
OBsolete		42	40	42	7	0			42	40	42	2	0
OBsolete		40	38	40	6	-9			40	38	40	1	-9
OBsolete		38	36	38	6	-8			38	36	38	1	-8
OBsolete		36	34	36	6	-7			36	34	36	1	-7
OBsolete		34	32	34	6	-6			34	32	34	1	-6
OBsolete		32	30	32	6	-5			32	30	32	1	-5
OBsolete		30	28	30	6	-4			30	28	30	1	-4
OBsolete		28	26	28	6	-3			28	26	28	1	-3
OBsolete		26	24	26	6	-2			26	24	26	1	-2
OBsolete		24	22	24	6	-1			24	22	24	1	-1
OBsolete		22	20	22	6	0			22	20	22	1	0
OBsolete		20	18	20	5	-9			20	18	20		-9
OBsolete		18	16	18	5	-8			18	16	18		-8
OBsolete		16	14	16	5	-7			16	14	16		-7
OBsolete		14	12	14	5	-6			14	12	14		-6
OBsolete		12	10	12	5	-5			12	10	12		-5
OBsolete		10	8	10	5	-4			10	8	10		-4
OBsolete		8	6	8	5	-3			8	6	8		-3
OBsolete		6	4	6	5	-2			6	4	6		-2
OBsolete		4	2	4	5	-1			4	2	4		-1

THIS DRAWING IS A CONTROLLED DOCUMENT.

DWN	O.HU	30-NOV-2001	TE Connectivity AMPMODU 2.0mm PITCH REC CONN,VERTICAL MOUNT TYPE
CHK	J.CHENG	30-NOV-2001	
APVD	J.WU	30-NOV-2001	
PRODUCT SPEC	108-57197		
APPLICATION SPEC	-		RESTRICTED TO
WEIGHT	-	A3	SCALE 1:1
CUSTOMER DRAWING	SHEET 1 OF 2		REV E3

THIS DRAWING IS UNPUBLISHED  
 © COPYRIGHT 2009 By - ALL RIGHTS RESERVED.  
 RELEASED FOR PUBLICATION NOV ,2001.

LOC	DIST	REVISIONS			
P	LTR	DESCRIPTION	DATE	DWN	APVD
-	-	SEE SHEET 1	-	-	-

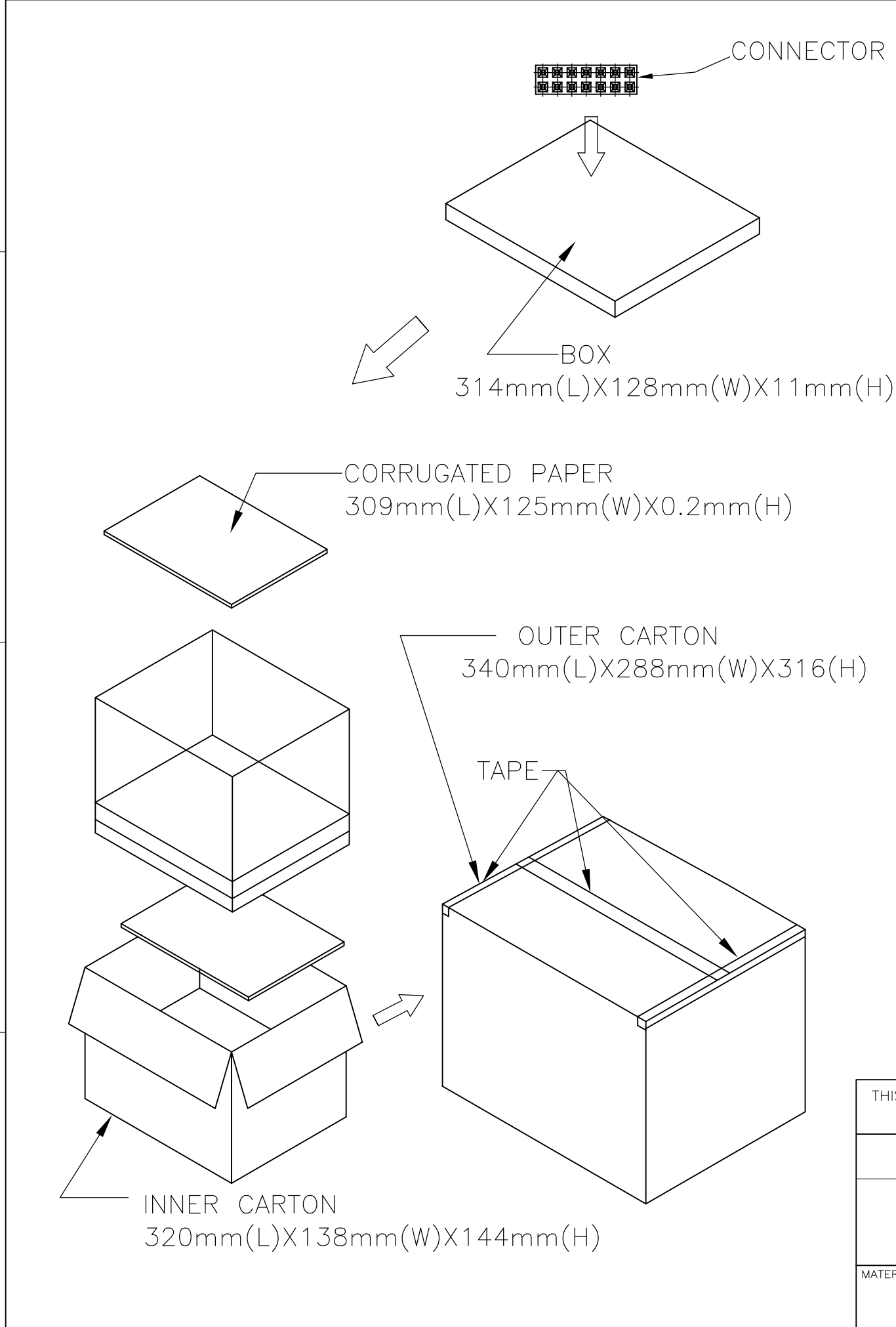

OBSOLETE	"L"	Pcs/Carton	Pcs/Inner Carton	Pcs/BOX	POS.	PART NUMBER
OBSOLETE	5040	1260	105	40	9	-9
OBSOLETE	4320	1080	90	50	9	-8
OBSOLETE	4320	1080	90	48	9	-7
OBSOLETE	4320	1080	90	46	9	-6
OBSOLETE	4320	1080	90	44	9	-5
OBSOLETE	5040	1260	105	42	9	-4
OBSOLETE	5040	1260	105	40	9	-3
OBSOLETE	5040	1260	105	38	9	-2
OBSOLETE	5760	1440	120	36	9	-1
OBSOLETE	5760	1440	120	34	9	0
OBSOLETE	6480	1620	135	32	8	-9
OBSOLETE	7200	1800	150	30	8	-8
OBSOLETE	7200	1800	150	28	8	-7
OBSOLETE	7920	1980	165	26	8	-6
OBSOLETE	8640	2160	180	24	8	-5
OBSOLETE	9360	2340	195	22	8	-4
OBSOLETE	10080	2520	210	20	8	-3
OBSOLETE	11520	2880	240	18	8	-2
OBSOLETE	12960	3240	270	16	8	-1
OBSOLETE	15120	3780	315	14	8	0
OBSOLETE	17280	4320	360	12	7	-9
OBSOLETE	20880	5220	435	10	7	-8
OBSOLETE	26640	6660	555	8	7	-7
OBSOLETE	35280	8820	735	6	7	-6
OBSOLETE	51840	12960	1080	4	7	-5
OBSOLETE	4320	1080	90	50	7	-4
OBSOLETE	4320	1080	90	48	7	-3
OBSOLETE	4320	1080	90	46	7	-2
OBSOLETE	4320	1080	90	44	7	-1
OBSOLETE	5040	1260	105	42	7	0
OBSOLETE	5040	1260	105	40	6	-9
OBSOLETE	5040	1260	105	38	6	-8
OBSOLETE	5760	1440	120	36	6	-7
OBSOLETE	5760	1440	120	34	6	-6
OBSOLETE	6480	1620	135	32	6	-5
OBSOLETE	7200	1800	150	30	6	-4
OBSOLETE	7200	1800	150	28	6	-3
OBSOLETE	7920	1980	165	26	6	-2
OBSOLETE	8640	2160	180	24	6	-1
OBSOLETE	9360	2340	195	22	6	0
OBSOLETE	10080	2520	210	20	5	-9
OBSOLETE	11520	2880	240	18	5	-8
OBSOLETE	12960	3240	270	16	5	-7
OBSOLETE	15120	3780	315	14	5	-6
OBSOLETE	17280	4320	360	12	5	-5
OBSOLETE	20880	5220	435	10	5	-4
OBSOLETE	26640	6660	555	8	5	-3
OBSOLETE	35280	8820	735	6	5	-2
OBSOLETE	51840	12960	1080	4	5	-1

OBSOLETE	"L"	Pcs/Carton	Pcs/Inner Carton	Pcs/BOX	POS.	PART NUMBER
OBSOLETE	5040	1260	105	40	4	-9
OBSOLETE	4320	1080	90	50	4	-8
OBSOLETE	4320	1080	90	48	4	-7
OBSOLETE	4320	1080	90	46	4	-6
OBSOLETE	4320	1080	90	44	4	-5
OBSOLETE	5040	1260	105	42	4	-4
OBSOLETE	5040	1260	105	40	4	-3
OBSOLETE	5040	1260	105	38	4	-2
OBSOLETE	5760	1440	120	36	4	-1
OBSOLETE	5760	1440	120	34	4	0
OBSOLETE	6480	1620	135	32	3	-9
OBSOLETE	7200	1800	150	30	3	-8
OBSOLETE	7200	1800	150	28	3	-7
OBSOLETE	7920	1980	165	26	3	-6
OBSOLETE	8640	2160	180	24	3	-5
OBSOLETE	9360	2340	195	22	3	-4
OBSOLETE	10080	2520	210	20	3	-3
OBSOLETE	11520	2880	240	18	3	-2
OBSOLETE	12960	3240	270	16	3	-1
OBSOLETE	15120	3780	315	14	3	0
OBSOLETE	17280	4320	360	12	2	-9
OBSOLETE	20880	5220	435	10	2	-8
OBSOLETE	26640	6660	555	8	2	-7
OBSOLETE	35280	8820	735	6	2	-6
OBSOLETE	51840	12960	1080	4	2	-5
OBSOLETE	4320	1080	90	50	2	-4
OBSOLETE	4320	1080	90	48	2	-3
OBSOLETE	4320	1080	90	46	2	-2
OBSOLETE	4320	1080	90	44	2	-1
OBSOLETE	5040	1260	105	42	2	0
OBSOLETE	5040	1260	105	40	1	-9
OBSOLETE	5040	1260	105	38	1	-8
OBSOLETE	5760	1440	120	36	1	-7
OBSOLETE	5760	1440	120	34	1	-6
OBSOLETE	6480	1620	135	32	1	-5
OBSOLETE	7200	1800	150	30	1	-4
OBSOLETE	7200	1800	150	28	1	-3
OBSOLETE	7920	1980	165	26	1	-2
OBSOLETE	8640	2160	180	24	1	-1
OBSOLETE	9360	2340	195	22	1	0
OBSOLETE	10080	2520	210	20		-9
OBSOLETE	11520	2880	240	18		-8
OBSOLETE	12960	3240	270	16		-7
OBSOLETE	15120	3780	315	14		-6
OBSOLETE	17280	4320	360	12		-5
OBSOLETE	20880	5220	435	10		-4
OBSOLETE	26640	6660	555	8		-3
OBSOLETE	35280	8820	735	6		-2
OBSOLETE	51840	12960	1080	4		-1

THIS DRAWING IS A CONTROLLED DOCUMENT.		DWN	O.HU	30-NOV-2001	 TE Connectivity AMPMODU 2.0mm PITCH REC CONN,VERTICAL MOUNT TYPE
DIMENSIONS: mm		CHK	J.CHENG	30-NOV-2001	
TOLERANCES UNLESS OTHERWISE SPECIFIED:		APVD	J.WU	30-NOV-2001	
0 PLC ± - 1 PLC ± 0.15 2 PLC ± 0.10 3 PLC ± 0.05 4 PLC ± - ANGLES ± 3°		PRODUCT SPEC		NAME	
MATERIAL SEE SHEET 1		FINISH SEE SHEET 1		108-57197	RESTRICTED TO
SEE SHEET 1		SEE SHEET 1		APPLICATION SPEC	SIZE
CUSTOMER DRAWING		WEIGHT -		A3	CAGE CODE
				-	DRAWING NO
				-	SCALE
				-	1:1
				-	SHEET
				-	2 OF 2
				-	REV
				-	E3



Компания «ЭлектроПласт» предлагает заключение долгосрочных отношений при поставках импортных электронных компонентов на взаимовыгодных условиях!

Наши преимущества:

- Оперативные поставки широкого спектра электронных компонентов отечественного и импортного производства напрямую от производителей и с крупнейших мировых складов;
- Поставка более 17-ти миллионов наименований электронных компонентов;
- Поставка сложных, дефицитных, либо снятых с производства позиций;
- Оперативные сроки поставки под заказ (от 5 рабочих дней);
- Экспресс доставка в любую точку России;
- Техническая поддержка проекта, помощь в подборе аналогов, поставка прототипов;
- Система менеджмента качества сертифицирована по Международному стандарту ISO 9001;
- Лицензия ФСБ на осуществление работ с использованием сведений, составляющих государственную тайну;
- Поставка специализированных компонентов (Xilinx, Altera, Analog Devices, Intersil, Interpoint, Microsemi, Aeroflex, Peregrine, Syfer, Eurofarad, Texas Instrument, Miteq, Cobham, E2V, MA-COM, Hittite, Mini-Circuits, General Dynamics и др.);

Помимо этого, одним из направлений компании «ЭлектроПласт» является направление «Источники питания». Мы предлагаем Вам помощь Конструкторского отдела:

- Подбор оптимального решения, техническое обоснование при выборе компонента;
- Подбор аналогов;
- Консультации по применению компонента;
- Поставка образцов и прототипов;
- Техническая поддержка проекта;
- Защита от снятия компонента с производства.



#### Как с нами связаться

**Телефон:** 8 (812) 309 58 32 (многоканальный)

**Факс:** 8 (812) 320-02-42

**Электронная почта:** [org@eplast1.ru](mailto:org@eplast1.ru)

**Адрес:** 198099, г. Санкт-Петербург, ул. Калинина, дом 2, корпус 4, литера А.