

Surface Mount EMI Filters

our family of surface mount filters is designed to provide a range of high performance EMI filtering options with a minimal PCB footprint



Advantages of a Surface Mount Filter

With many years of experience in the design and manufacture of filters, API Technologies has a unique perspective on EMI and how to control it. We provide an integrated approach to EMC problems with services such as customer consulting, diagnostic testing, design and manufacturing. By offering a variety of custom assemblies, we are able to unite your specific requirements with our high performance filters.

API's Spectrum Control line of surface mount EMI filters are ideal for a wide range of PCB applications, including: automotive electronics, digital A/V equipment, computers, peripherals, telecommunications, switching power supplies and high current buss lines.

Three Terminal Chips offer superior ability to withstand transient voltages and surges, and deliver excellent filtering performance in high current applications while providing exceptional solderability and resistance to solder heat... **SM2-SM7**

SA Series Arrays incorporate four lines in one compact footprint. These arrays are nonpolar and designed to minimize residual inductance, thereby ensuring large insertion loss in a wide band and better cross talk control... **SM8-SM9**

MSM Mini-Surface Mount offers a multilayer electrode structure, high temperature construction and 10 Amps current ratings. The filter chips provide extreme elimination of residual inductance and the self-resonant frequency extends the microwave band... **SM11**

SSM Square Surface Mount square mechanical geometry enhances SMT soldering in applications up to 10 Amps. These filters come in a Pi circuit configuration and are designed to address EMI/RFI on crowded printed circuit boards... **SM12-SM13**

PSM Power Surface Mount are the first high temperature surface mount filter designed to effectively filter EMI/RFI at currents up to 20 Amps. These filters come in either a Feed-through or Pi circuit configuration and offer superior high frequency noise suppression... **SM14-SM15**

MSP Mini Surface Mount Power Filters offers a multilayer electrode structure, high temperature construction and 10 Amps current ratings. The filter chips provide extreme elimination of residual inductance and the self-resonant frequency extends to the microwave band... **SM16**

MPC Series Miniature PCB Power Filters are designed to fit a wide range of environments. These filters are ideal for personal computers and peripherals, home appliances, measuring instruments and medical equipment, and are all available lead free... **SM17-SM20**

High Frequency PCB Filters provide EMI filtering to protect low power digital circuits. With mounting directly on the printed circuit board, filtering begins at the source of the problem... **SM21**



Surface Mount EMI Filters Three Terminal Chips

Features

- Excellent performance in high current applications
- Non-polar, surface mountable
- Superior filtering characteristics
- Superb ability to withstand transient voltages and surge
- Offers exceptional solderability and resistance to solder heat
- Available in 0603, 0805, 1205 and 1806 body size
- Two amp current rating available
- Available lead free/RoHS Compliant

Applications

- Cellular telephones and base stations
- Telecommunication equipment
- Industrial electronic interface or programmable controllers
- Electronic automotive equipment
- Computer and peripheral equipment



Circuit Schematic



Typical Electrical Characteristics

Capacitance Range COG (NPO) 22 pF to 470 pF
 X7R 470 pF to 47,000 pF
 YV5 100,000 pF and 220,000 pF

Capacitance Tolerance COG (NPO) +50/-20%
 X7R +50/-20%
 Y5V +80/-20%

Temperature Coefficient COG (NPO) 0 ±30 ppm/°C, -55 to +125°C
 X7R +/-15%, -55 to +125°C
 Y5V -25 to +85°C

Insulation Resistance up to 22,000 pF 10000 Megohms
 47,000 pF 5000 Megohms

DC Resistance 0.4 Amp or less 0.3 ohm max.
 1 Amp 0.08 ohm max.
 2 Amp 0.04 ohm max.

Rated Voltage up to 100 VDC

Rated Current up to 2 Amps

Surface Mount EMI Filters Three Terminal Chips

Selection Guide

| Part Number | Body Size | Capacitance (in picofarad) | Capacitance Tolerance | Temp. Charact. | Rated Voltage (Volts DC) | Rated Current (Amps DC) | IR (Megohms Min.) | DC Resistance (ohm Max.) | Operating Temp. |
|--|-------------|----------------------------|-----------------------|----------------|--------------------------|-------------------------|-------------------|--------------------------|-------------------|
| SF0603C220SBNB-* | 0603 | 22 | +50/-20% | COG | 50 | 0.3 | 10,000 | 0.3 | -55/+125°C |
| SF0603C470SBNB-* | 0603 | 47 | +50/-20% | COG | 50 | 0.3 | 10,000 | 0.3 | -55/+125°C |
| SF0603C101SBNB-* | 0603 | 100 | +50/-20% | COG | 50 | 0.3 | 10,000 | 0.3 | -55/+125°C |
| SF0603C221SBNB-* | 0603 | 220 | +50/-20% | COG | 50 | 0.3 | 10,000 | 0.3 | -55/+125°C |
| SF0603X471SBNB-* | 0603 | 470 | +50/-20% | X7R | 50 | 0.3 | 10,000 | 0.3 | -55/+125°C |
| SF0603X102SBNB-* | 0603 | 1,000 | +50/-20% | X7R | 50 | 0.3 | 10,000 | 0.3 | -55/+125°C |
| SF0603X222SBNB-* | 0603 | 2,200 | +50/-20% | X7R | 50 | 0.3 | 10,000 | 0.3 | -55/+125°C |
| SF0603X223SANC-* | 0603 | 22,000 | +50/-20% | X7R | 25 | 0.5 | 10,000 | 0.15 | -55/+125°C |
| SF0603Y104MAND-* | 0603 | 100,000 | ±20% | Y5V† | 25 | 1 | 1,000 | 0.08 | -25/+85°C |
| SF0805C220SBNC-* | 0805 | 22 | +50/-20% | COG | 50 | 0.4 | 10,000 | 0.3 | -55/+125°C |
| SF0805C470SBNC-* | 0805 | 47 | +50/-20% | COG | 50 | 0.4 | 10,000 | 0.3 | -55/+125°C |
| SF0805C101SBNC-* | 0805 | 100 | +50/-20% | COG | 50 | 0.4 | 10,000 | 0.3 | -55/+125°C |
| SF0805C221SBNC-* | 0805 | 220 | +50/-20% | COG | 50 | 0.4 | 10,000 | 0.3 | -55/+125°C |
| SF0805X471SBNC-* | 0805 | 470 | +50/-20% | X7R | 50 | 0.4 | 10,000 | 0.3 | -55/+125°C |
| SF0805X102SBNC-* | 0805 | 1,000 | +50/-20% | X7R | 50 | 0.4 | 10,000 | 0.3 | -55/+125°C |
| SF0805X222SBNC-* | 0805 | 2,200 | +50/-20% | X7R | 50 | 0.4 | 10,000 | 0.3 | -55/+125°C |
| SF0805X223SBND-* | 0805 | 22,000 | +50/-20% | X7R | 50 | 1.0 | 10,000 | 0.08 | -55/+125°C |
| SF1205C220SBNB-* | 1205 | 22 | +50/-20% | COG | 50 | 0.3 | 10,000 | 0.3 | -55/+125°C |
| SF1205C470SBNB-* | 1205 | 47 | +50/-20% | COG | 50 | 0.3 | 10,000 | 0.3 | -55/+125°C |
| SF1205C101SBNB-* | 1205 | 100 | +50/-20% | COG | 50 | 0.3 | 10,000 | 0.3 | -55/+125°C |
| SF1205C221SBNB-* | 1205 | 220 | +50/-20% | COG | 50 | 0.3 | 10,000 | 0.3 | -55/+125°C |
| SF1205X471SBNB-* | 1205 | 470 | +50/-20% | X7R | 50 | 0.3 | 10,000 | 0.3 | -55/+125°C |
| SF1205X102SBNB-* | 1205 | 1,000 | +50/-20% | X7R | 50 | 0.3 | 10,000 | 0.3 | -55/+125°C |
| SF1205X222SBNB-* | 1205 | 2,200 | +50/-20% | X7R | 50 | 0.3 | 10,000 | 0.3 | -55/+125°C |
| SF1205X223SBNB-* | 1205 | 22,000 | +50/-20% | X7R | 50 | 0.3 | 10,000 | 0.3 | -55/+125°C |
| SF1205X473SBND-* | 1205 | 47,000 | +50/-20% | X7R | 50 | 1.0 | 5,000 | 0.08 | -55/+125°C |
| SF1806C220SDNB-* | 1806 | 22 | +50/-20% | COG | 100 | 0.3 | 10,000 | 0.3 | -55/+125°C |
| SF1806C470SDNB-* | 1806 | 47 | +50/-20% | COG | 100 | 0.3 | 10,000 | 0.3 | -55/+125°C |
| SF1806C101SDNB-* | 1806 | 100 | +50/-20% | COG | 100 | 0.3 | 10,000 | 0.3 | -55/+125°C |
| SF1806C221SDNB-* | 1806 | 220 | +50/-20% | COG | 100 | 0.3 | 10,000 | 0.3 | -55/+125°C |
| SF1806C471SDNB-* | 1806 | 470 | +50/-20% | COG | 100 | 0.3 | 10,000 | 0.3 | -55/+125°C |
| SF1806X102SDNB-* | 1806 | 1,000 | +50/-20% | X7R | 100 | 0.3 | 10,000 | 0.3 | -55/+125°C |
| SF1806X222SDNB-* | 1806 | 2,200 | +50/-20% | X7R | 100 | 0.3 | 10,000 | 0.3 | -55/+125°C |
| SF1806X103SDNB-* | 1806 | 10,000 | +50/-20% | X7R | 100 | 0.3 | 10,000 | 0.3 | -55/+125°C |
| SF1806X223SDNB-* | 1806 | 22,000 | +50/-20% | X7R | 100 | 0.3 | 10,000 | 0.3 | -55/+125°C |
| 2 AMP FILTER SF1806Y224ZBNE-* | 1806 | 220,000 | +80/-20% | Y5V† | 50 | 2.0 | 1,000 | 0.04 | -25/+85°C |

Bold Letter = High Current Applications
 † = Temperature Characteristic is +30/-80%

* = Denotes Packaging Style. Replace with T for Tape and Reel or B for Bulk

Surface Mount EMI Filters Three Terminal Chips

Insertion Loss (Per MIL-STD-220)

SF0603 Series



SF0805 Series



SF1205 Series



SF1806 Series



Surface Mount EMI Filters Three Terminal Chips



Mechanical Dimensions

Dimensions in inches (mm)

| Body Style/Size | Body Length (L) | Body Width (W) | Body Thickness (T) | End Terminal Length (LE) | Middle Terminal Length (LM) |
|-----------------|----------------------------------|----------------------------------|---------------------------------|---------------------------------|---------------------------------|
| SF0603 | 0.063 +/-0.006 (1.60 +/-0.15) | 0.031 +/-0.006 (0.80 +/-0.15) | 0.023 +/-0.006 (0.6 +/-0.15) | 0.008 +/-0.006 (0.2 +/-0.15) | 0.020 +/-0.006 (0.5 +/-0.15) |
| SF0805 | 0.079 +/-0.008 (2.0 +/-0.2) | 0.049 +/-0.008 (1.25 +/-0.2) | 0.032 +/-0.008 (0.8 +/-0.2) | 0.012 +/-0.008 (0.3 +/-0.2) | 0.024 +/-0.008 (0.6 +/-0.2) |
| SF1205 | 0.126 +/-0.008 (3.2 +/-0.2) | 0.049 +/-0.008 (1.25 +/-0.2) | 0.028 +/-0.008 (0.7 +/-0.2) | 0.016 +/-0.012 (0.4 +/-0.3) | 0.043 +/-0.012 (1.1 +/-0.3) |
| SF1806 | 0.177 +/-0.012 (4.5 +/-0.3) | 0.063 +/-0.012 (1.6 +/-0.3) | 0.039 +/-0.012 (1.0 +/-0.3) | 0.020 +/-0.012 (0.5 +/-0.3) | 0.055 +/-0.012 (1.4 +/-0.3) |

Ordering Information

Example: **SF0805C221SBNCT**

This part number represents a three terminal chip with a body size of 0805 with a COG (NPO) dielectric. The capacitance is 220 pF with a capacitance tolerance of +50%/-20%. Voltage rating is 50 Volts DC. It has nickel barrier, solder plated terminations and a current rating of 0.4 Amp, (400 milliamps). The parts are taped and reeled.

| SF | 0805 | C | 221 | S | B | N | C | T |
|-------|------------------------------|-------------------------------|--|--------------------------------|-----------------------------|-------------------------------------|--|-----------------------------|
| Style | Size | Ceramic | Capacitance Code | Capacitance Tolerance | Rated Voltage (Vdc) | Termination | Current Rating | Packaging |
| SF | 0603 0805 1205 1806 | C - COG X - X7R Y - Y5V | First two numbers are significant, the third number refers to number of zeroes | S - +50%/-20% Z - +80%/-20% | A - 25 B - 50 D - 100 | N - Ni Barrier, Solder Plated | B - 0.3 A C - 0.4 A D - 1 A E - 2 A F - 3 A G - 4 A H - 5 A I - 6 A | T - Tape & Reel B - Bulk |

Surface Mount EMI Filters Three Terminal Chips Soldering Specifications

Soldering Instructions

Reflow Soldering



Board Pattern Dimensions in inches (mm)

| Body Style/Size | Dimension | | |
|-----------------|----------------|----------------|----------------|
| | A | B | C |
| SF0603 | 0.020 (0.5) | 0.047 (1.2) | 0.031 (0.8) |
| SF0805 | 0.024 (0.6) | 0.059 (1.5) | 0.039 (1.0) |
| SF1205 | 0.051 (1.3) | 0.091 (2.3) | 0.047 (1.2) |
| SF1806 | 0.079 (2.0) | 0.138 (3.5) | 0.051 (1.3) |

Reflow Soldering



General Soldering Notes

1. High soldering temperatures and long soldering times can cause leaching of the termination and adversely affect adhesion. These conditions can also decrease capacitance value. Use the above recommended solder temperature cycle.
2. Due to the mechanical characteristic of ceramic composition, aggressive thermal shock will degrade performance. Preheat the assembly before soldering using the above solder temperature profile as a guide.

Flow Soldering



Board Pattern Dimensions in inches (mm)

| Body Style/Size | Dimension | | | | | |
|-----------------|----------------|----------------|----------------|----------------|----------------|----------------|
| | A | B | C | D | E | F |
| SF0603 | 0.020 (0.5) | 0.031 (0.8) | 0.047 (1.2) | 0.031 (0.8) | 0.071 (1.8) | 0.016 (0.4) |
| SF0805 | 0.024 (0.6) | 0.031 (0.8) | 0.059 (1.5) | 0.039 (1.0) | 0.087 (2.2) | 0.024 (0.6) |
| SF1205 | 0.051 (1.3) | 0.059 (1.5) | 0.091 (2.3) | 0.047 (1.2) | 0.118 (3.0) | 0.024 (0.6) |
| SF1806 | 0.059 (1.5) | 0.079 (1.5) | 0.138 (3.5) | 0.051 (1.3) | 0.118 (3.0) | 0.024 (0.6) |

Flow Soldering



3. Use mild flux (less than 0.2% by weight of Chlorine), preferable rosin based. If water soluble, wash thoroughly to assure all residue is removed from the underside of components.
4. Ultrasonic Cleaning
When using an ultrasonic cleaning method, the following range is recommended:
Frequency: Not to exceed 28kHz
Output Power: Not to exceed 20W/liter
Cleaning Time: 5 minutes max

Surface Mount EMI Filters
Three Terminal Chips
Soldering Specifications

Package Quantities

| Body Style/Size | Tape and Reel |
|-----------------|------------------|
| SF0603 | 4,000 units/reel |
| SF0805 | 4,000 units/reel |
| SF1205 | 4,000 units/reel |
| SF1806 | 2,000 units/reel |

Package Information
Paper Tape Dimensions
SF0805 and SF1205 Bodies



Dimensions in inches (mm)

| Body Style/Size | Chip Cavity | | Tape | | | Holes | | | Hole Diameter | | Thickness | |
|-----------------|---------------|--------------|--------------|-----------------|-------------------|--------------------|-----------------------|-------------------------|-----------------|------------------|------------------------|--|
| | Length A | Width B | Width W | Center to End F | Indexing to End E | Center to Center C | Indexing to Center C1 | Indexing to Indexing C2 | Indexing D1 | Overall T (Max.) | Carrier Tape T1 (Max.) | |
| SF0603 | 0.039 | 0.075 | 0.315 | 0.138 | 0.069 | 0.157 | 0.079 | 0.157 | 0.059 | 0.043 | 0.039 | |
| | +/-0.00? | +/-0.00? | +/-0.012 | +/-0.002 | +/-0.004 | +/-0.004 | +/-0.004 | +/-0.008 | +0.004/-0 | (1.1) | (1.0) | |
| | (1.0 +/-0.?) | (1.9 +/-0.?) | (8.0 +/-0.3) | (3.5 +/-0.05) | (1.75 +/-0.1) | (4.0 +/-0.1) | (2.0 +/-0.1) | (4.0 +/-0.1) | (1.5 +/-0.1/-0) | | | |
| SF0805 | 0.064 | 0.091 | 0.315 | 0.138 | 0.069 | 0.157 | 0.079 | 0.157 | 0.059 | 0.043 | 0.039 | |
| | +/-0.008 | +/-0.008 | +/-0.012 | +/-0.002 | +/-0.004 | +/-0.004 | +/-0.004 | +/-0.008 | +0.004/-0 | (1.1) | (1.0) | |
| | (1.62 +/-0.2) | (2.3 +/-0.2) | (8.0 +/-0.3) | (3.5 +/-0.05) | (1.75 +/-0.1) | (4.0 +/-0.1) | (2.0 +/-0.1) | (4.0 +/-0.1) | (1.5 +/-0.1/-0) | | | |
| SF1205 | 0.067 | 0.138 | 0.315 | 0.138 | 0.069 | 0.157 | 0.079 | 0.157 | 0.059 | 0.043 | 0.039 | |
| | +/-0.008 | +/-0.008 | +/-0.012 | +/-0.002 | +/-0.004 | +/-0.004 | +/-0.004 | +/-0.008 | +0.004/-0 | (1.1) | (1.0) | |
| | (1.70 +/-0.2) | (3.5 +/-0.2) | (8.0 +/-0.3) | (3.5 +/-0.05) | (1.75 +/-0.1) | (4.0 +/-0.1) | (2.0 +/-0.1) | (4.0 +/-0.1) | (1.5 +/-0.1/-0) | | | |

Plastic Reel Dimensions

Dimensions in inches (mm)

| Body Style/Size | Diameter (Max.) | Width (Max.) |
|-----------------|-----------------|--------------|
| SF0603 | 7.00 (180) | 0.46 (11.5) |
| SF0805 | 7.00 (180) | 0.46 (11.5) |
| SF1205 | 7.00 (180) | 0.46 (11.5) |
| SF1806 | 7.00 (180) | 0.61 (11.5) |

Package Information
Tape and Reel Specification
Plastic Carrier Tape Dimensions
SF1806 Body



Dimensions in inches (mm)

| Body Style/Size | Chip Cavity | | Tape | | | Holes | | | Hole Diameter | | Thickness | |
|-----------------|---------------|---------------|---------------|-----------------|-------------------|--------------------|-----------------------|-------------------------|-----------------|-----------------|------------------|----------------|
| | Length A | Width B | Width W | Center to End F | Indexing to End E | Center to Center C | Indexing to Center C1 | Indexing to Indexing C2 | Center D (Min.) | Indexing D1 | Overall T (Max.) | Tape T1 (Max.) |
| SF1806 | 0.071 | 0.185 | 0.472 | 0.217 | 0.069 | 0.157 | 0.079 | 0.157 | 0.059 | 0.059 | 0.098 | 0.024 |
| | +/-0.008 | +/-0.008 | +/-0.008 | +/-0.002 | +/-0.004 | +/-0.004 | +/-0.004 | +/-0.008 | +0.004/-0 | | (2.5) | (0.6) |
| | (1.80 +/-0.2) | (4.70 +/-0.2) | (12.0 +/-0.2) | (5.5 +/-0.05) | (1.75 +/-0.1) | (4.0 +/-0.1) | (2.0 +/-0.1) | (4.0 +/-0.1) | (1.5) | (1.5 +/-0.1/-0) | | |

Surface Mount Filter Arrays SA Series

Features

- The filter's structure minimizes residual inductance with a high self resonant frequency, ensuring large insertion loss in a wide band.
- The common ground electrode built into the chip ensures complete grounding of all lines at the ground on both ends. The filter is designed to control cross talk.
- An optimum constant can be selected from the capacity range of 22-22,000 pF to best suit the frequency.
- Solder plated nickel barrier terminations offer good solderability and resistance to soldering heat.
- Available lead free/RoHs compliant

Applications

- Noise reduction for DC lines on computers
- Computer peripheral equipment
- Digital TV & VTR
- Cellular telephones
- Automotive electronics

Typical Electrical Characteristics

Rated Voltage 25 VDC to 50 VDC

Rated Current 0.3 Amps

IR 10,000 MΩ Min.

DC Resistance 0.3 Ω Max.

Temperature Range -55°C to +125°C

Capacitance Range 22 pF to 22,000 pF

Capacitance Tolerance ±20%

Specifications

| Part Number | Rated Voltage (@ 50/60Hz) | Rated Current | Temperature Characteristic | IR | DC Resistance | Operating Temp | Capacitance (pF) |
|-------------|---------------------------|---------------|----------------------------|----------------|---------------|----------------|------------------|
| SA1206C220 | 50 VDC | 0.3A DC | C | 10,000 MΩ min. | 0.3Ω max. | -55/+125°C | 22 |
| SA1206C470 | | | C | | | | 47 |
| SA1206C101 | | | C | | | | 100 |
| SA1206C221 | | | C | | | | 220 |
| SA1206R471 | | | U | | | | 470 |
| SA1206R102 | | | R | | | | 1,000 |
| SA1206R222 | | | R | | | | 2,200 |
| SA1206R223 | 25 VDC | | R | | | | 22,000 |



Circuit Schematic

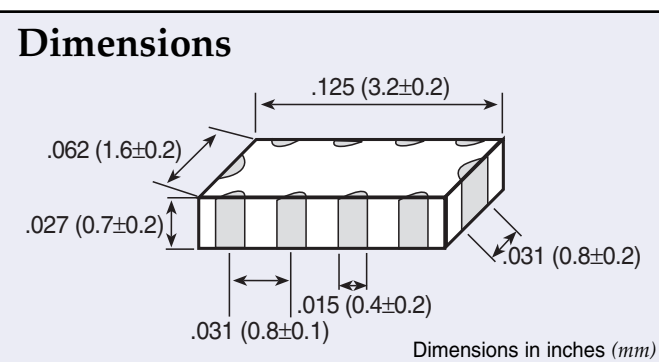
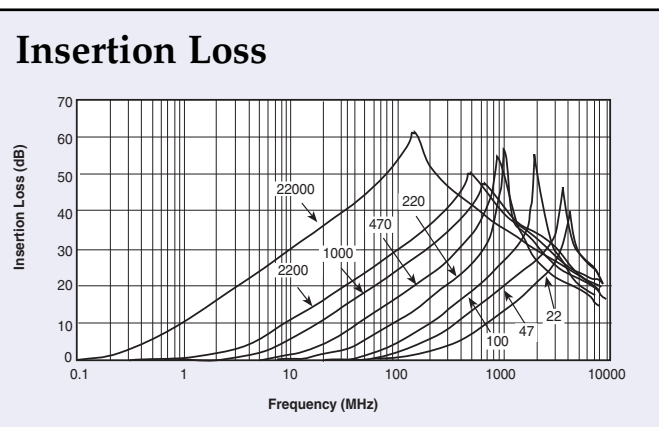
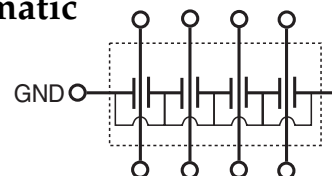

Surface Mount Filter Arrays SA Series

Ordering Information

| SA | 1206 | C | 220 | M | B | N | B |
|-----------|------|---|---|-----------------------|---------------------|------------------------------|--|
| Style | Size | Temperature Characteristics | Capacitance | Capacitance tolerance | Rated Voltage (Vdc) | Termination | Packaging |
| SA Series | 1206 | C +/- 30 ppm/°C R +/- 15% U -750 +/- 120 ppm/°C | 22 pF 47 pF 100 pF 220 pF 470 pF 1,000 pF 2,200 pF 22,000 pF | M = ± 20% | A = 25 B = 50 | N = Ni Barrier Solder Plated | T - Tape and reel 4,000 pc/reel B - Bulk pack 1,000 pcs/bag |

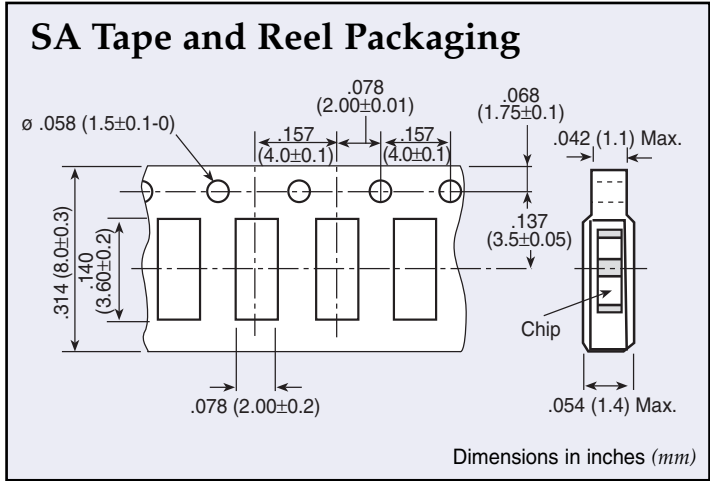

Surface Mount Low Pass Filters MSM, SSM, RSM & PSM Series

MSM - Miniature Surface Mount Chip Capacitors



The MSM series filters feature high temperature construction and have current ratings up to 10 Amps. The filter chips will hardly allow residual inductance and the self-resonant frequency extends to the microwave band. Applications include telecommunication equipment, computer and peripheral equipment and digital AV equipment, medical equipment, DC power supply lines.

- Miniature footprint help in dense circuit configuration
- Rated at 10 Amps
- Packaged in tape and reel or bulk form
- Operating temperature ranges of -25°C to $+85^{\circ}\text{C}$ and -55°C to $+125^{\circ}\text{C}$
- Available lead free/RoHs compliant

SSM - Square Surface Mount Filters



The SSM series filters feature high temperature construction and have current ratings up to 10 Amps. This filter chip series is nonpolar and surface mountable with excellent performance characteristics and comes in a Pi circuit configuration. Applications include telecommunication equipment, computer and peripheral equipment, digital AV equipment, power amplifiers, power supplies and high current bus lines.

- Square mechanical geometry enhances SMT soldering
- Rated to 10 Amps
- Packaged in tape and reel or bulk form
- Operating temperature range of -55°C to $+125^{\circ}\text{C}$
- Available lead free/RoHs compliant

RSM - Round Surface Mount Filters



The RSM series filters feature high temperature construction and have current ratings up to 10 Amps. This filter chip series is nonpolar and surface mountable with excellent performance characteristics and comes in a Pi circuit configuration. Applications include telecommunication equipment, computer and peripheral equipment, digital AV equipment, power amplifiers, power supplies and high current bus lines.

- Round mechanical geometry enhances SMT soldering
- Rated to 10 Amps
- Packaged in tape and reel or bulk form
- Operating temperature range of -55°C to $+125^{\circ}\text{C}$
- Available lead free/RoHs compliant

PSM - Power Surface Mount Filters



The PSM series filters feature high temperature construction and have current ratings up to 20 Amps. This filter series is nonpolar and surface mountable with excellent performance characteristics and comes in either a Feed-through or Pi circuit configuration. Applications include telecommunication equipment, computer and peripheral equipment, digital AV equipment, power amplifiers, power supplies and high current bus lines.

- Provides time and costs saving compared to through-hole filters
- Rated to 20 Amps
- Packaged in tape and reel or bulk form
- Operating temperature range of -55°C to $+125^{\circ}\text{C}$
- Available lead free/RoHs compliant

Surface Mount Low Pass Filters MSM Series

MSM



Working Voltage 50 VDC
 Test Voltage 150 VDC
 Current Rating 10 Amps max.
 Insulation Resistance 1.0 MΩ
 Terminations Ni-Barrier
 Soldering Conditions Max. 250°C-5 sec.

Insertion Loss

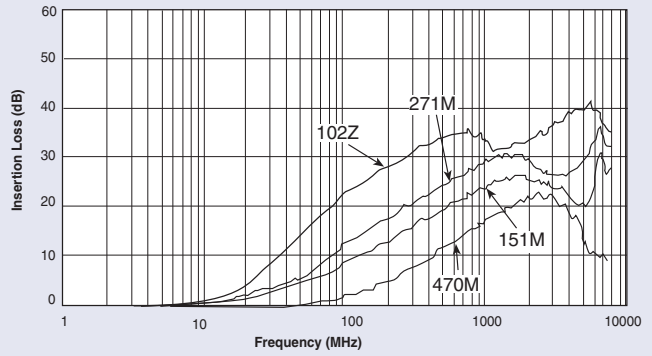

MSM

Dimensions in inches (mm)

MSM Ordering Information

MSM

Style

MSM
(Miniature)

4

Circuit
Configuration
4 - Feed-Through

T

Temperature
Characteristic
R - +/-15%
T - +22/-33%
V - +22/-82%

470M

Capacitance

| Value | Tolerance |
|-------|-----------|
| 47 pF | +50/- 20% |

10

Current
Rating
10 Amps

T

Packaging

T - Tape and Reel
2,000 pcs/reel
B - Bulk pack
1,000pcs/reel

Specifications

| Part Number | Temperature Characteristics | Capacitance | Capacitance Tolerance | Current Rating | Rated Rating | Temperature Range |
|-------------|-----------------------------|-------------|-----------------------|----------------|--------------|-------------------|
| MSM4T470M10 | T | 47pF | +50/-20% | 10A | 50VDC | -55/+125°C |
| MSM4R151M10 | R | 150pF | | | | -55/+125°C |
| MSM4R271M10 | R | 270pF | | | | -55/+125°C |
| MSM4V102M10 | V | 1000pF | | | | -25/+85°C |

MSM Recommended Board Pattern

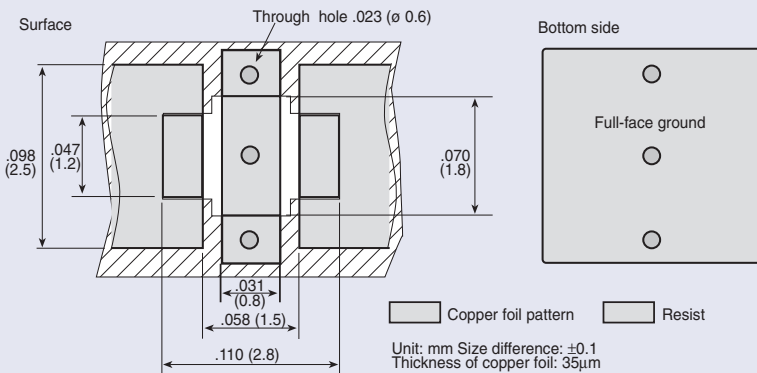

Note: Exclusively for reflow soldering

MSM Tape and Reel Packaging



Dimensions in inches (mm)

Surface Mount Low Pass Filters SSM & RSM Series

SSM



- Working Voltage 100 VDC
- Test Voltage 250 VDC
- Current Max. 10 Amps
- Insulation Resistance Min. 10^4 M Ω
- Terminations Silver Ni-Tin plated
- Soldering Conditions Max. 250°C -5 sec.
- Marking None
- Packaging Bulk or tape and reel

Note: Insertion loss shown for the following SSM values* only:

- 101Z
- 501P
- 202P

*Additional IL charts available by request.

RSM



- Working Voltage 100 VDC
- Test Voltage 250 VDC
- Current Max. 10 Amps
- Insulation Resistance Min. 10^4 M Ω
- Terminations Silver Ni-Tin plated
- Soldering Conditions Max. 250°C -5 sec.
- Marking None
- Packaging Bulk or tape and reel

Note: Insertion loss shown for the following RSM values only:

- 152P
- 402Z

Pi Insertion Loss

Typical SMT Applications



Shielded or Partition Applications



* Capacitance values for insertion loss curves are displayed left to right in the order shown.

SSM



RSM



Dimensions in inches (mm)

Surface Mount Low Pass Filters SSM & RSM Series

SSM & RSM Ordering Information

Example: **SSM1-101Z-05T 1**

| | | | | | | | |
|-----------------------------|------------------------------|----------|--------------------|----------|-----------------------------|---|---|
| SSM | 1 | - | 101Z | - | 05 | T | 1 |
| Style | Circuit Configuration | | Capacitance | | Current Rating | Packaging | Tape and Reel |
| SSM (Square) RSM (Round) | 1 - Pi | | | | 05 - 5 Amps 10 - 10 Amps | T - Tape and reel packaging B - Bulk packaging | 1 - 1,000 pieces 6 - 6,000 pieces <i>Note: Tape and reel packaging - 1,000 pieces (7") and 6,000 pieces (13")</i> |

| Code | Value | Tolerance |
|------|---------|-----------|
| 101Z | 100 pF | +80/-20% |
| 501P | 500 pF | +100/-0% |
| 152P | 1500 pF | +100/-0% |
| 202P | 2000 pF | +100/-0% |
| 402E | 4000 pF | ±25 |
| 402Z | 4000 pF | +80/-20% |

† Also available through API's authorized distributors.
 € Also available through API's authorized European distributors/agents.
 † SSM1-152P-05-T1 €

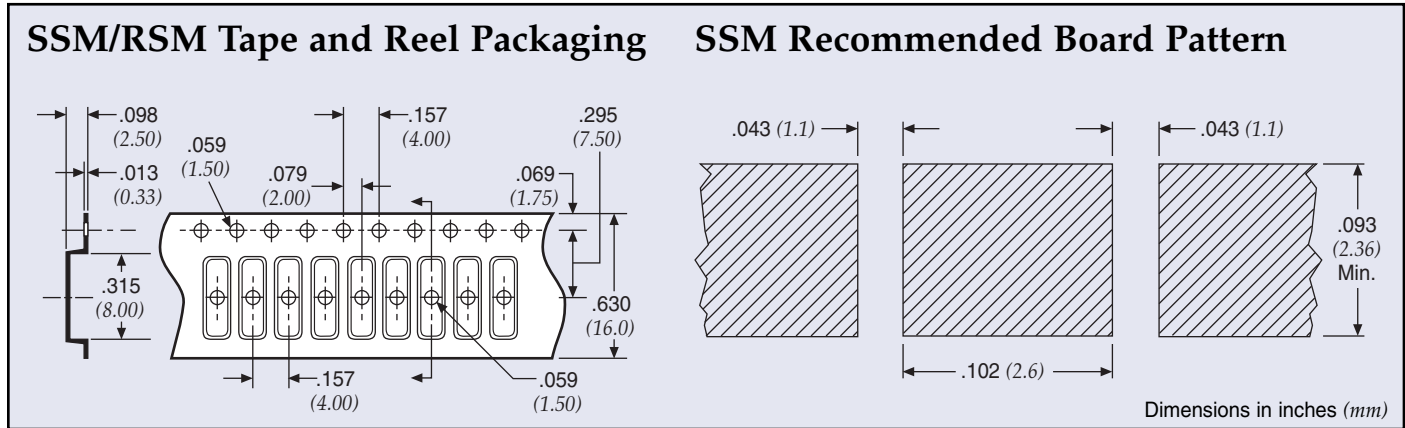

Surface Mount Low Pass Filters PSM Series

PSM Ordering Information

Example: **PSM4-402Z-20T0**

| PSM | 4 | - | 402Z | - | 20 | T | 0 | | | | | | | | | | | | | | | | | | | | | | | | | | | | | | | | | |
|--|------------------------------|-----------|---|------|-----------------------|------------------|----------------------|-------|------|------|--------|------|------|--------|----------|------|--------|----------|------|--------|------|------|---------|------|------|---------|------|------|---------|----------|------|---------|---------|--------|--------|----------|--|--|---|---|
| Style | Circuit Configuration | | Capacitance | | Current Rating | Packaging | Tape and Reel | | | | | | | | | | | | | | | | | | | | | | | | | | | | | | | | | |
| PSM (Power) | 1 - Pi 4 - Feed-through | | <table border="1"> <thead> <tr> <th>Code</th> <th>Value*</th> <th>Tolerance</th> </tr> </thead> <tbody> <tr><td>680M</td><td>68 pF</td><td>±20%</td></tr> <tr><td>101M</td><td>100 pF</td><td>±20%</td></tr> <tr><td>131P</td><td>130 pF</td><td>+100/-0%</td></tr> <tr><td>471P</td><td>470 pF</td><td>+100/-0%</td></tr> <tr><td>821M</td><td>820 pF</td><td>±20%</td></tr> <tr><td>102M</td><td>1000 pF</td><td>±20%</td></tr> <tr><td>152M</td><td>1500 pF</td><td>±20%</td></tr> <tr><td>252P</td><td>2500 pF</td><td>+100/-0%</td></tr> <tr><td>402Z</td><td>4000 pF</td><td>+80/20%</td></tr> <tr><td>103Z**</td><td>.01 μF</td><td>+80/-20%</td></tr> </tbody> </table> | Code | Value* | Tolerance | 680M | 68 pF | ±20% | 101M | 100 pF | ±20% | 131P | 130 pF | +100/-0% | 471P | 470 pF | +100/-0% | 821M | 820 pF | ±20% | 102M | 1000 pF | ±20% | 152M | 1500 pF | ±20% | 252P | 2500 pF | +100/-0% | 402Z | 4000 pF | +80/20% | 103Z** | .01 μF | +80/-20% | | 10 - 10 Amps (Pi) 20 - 20 Amps (Feed-through) | T - Tape and reel packaging B - Bulk packaging | 0 - 500 pieces 2 - 2,000 pieces <i>Note: Tape and reel packaging - 500 pieces (7") and 2,000 pieces (13")</i> |
| Code | Value* | Tolerance | | | | | | | | | | | | | | | | | | | | | | | | | | | | | | | | | | | | | | |
| 680M | 68 pF | ±20% | | | | | | | | | | | | | | | | | | | | | | | | | | | | | | | | | | | | | | |
| 101M | 100 pF | ±20% | | | | | | | | | | | | | | | | | | | | | | | | | | | | | | | | | | | | | | |
| 131P | 130 pF | +100/-0% | | | | | | | | | | | | | | | | | | | | | | | | | | | | | | | | | | | | | | |
| 471P | 470 pF | +100/-0% | | | | | | | | | | | | | | | | | | | | | | | | | | | | | | | | | | | | | | |
| 821M | 820 pF | ±20% | | | | | | | | | | | | | | | | | | | | | | | | | | | | | | | | | | | | | | |
| 102M | 1000 pF | ±20% | | | | | | | | | | | | | | | | | | | | | | | | | | | | | | | | | | | | | | |
| 152M | 1500 pF | ±20% | | | | | | | | | | | | | | | | | | | | | | | | | | | | | | | | | | | | | | |
| 252P | 2500 pF | +100/-0% | | | | | | | | | | | | | | | | | | | | | | | | | | | | | | | | | | | | | | |
| 402Z | 4000 pF | +80/20% | | | | | | | | | | | | | | | | | | | | | | | | | | | | | | | | | | | | | | |
| 103Z** | .01 μF | +80/-20% | | | | | | | | | | | | | | | | | | | | | | | | | | | | | | | | | | | | | | |
| <p>† Also available through API's authorized distributors.</p> <p>* Other capacitance values available as special order.</p> <p>** Available in Feed-through circuit only.</p> | | | | | | | | | | | | | | | | | | | | | | | | | | | | | | | | | | | | | | | | |

Technical Notes

- Soldering recommendations supplied upon request
- Reflow temperature limit is 250°C
- Unit weight is approximately 0.4 grams
- Tape and reel packaging available for automated assembly

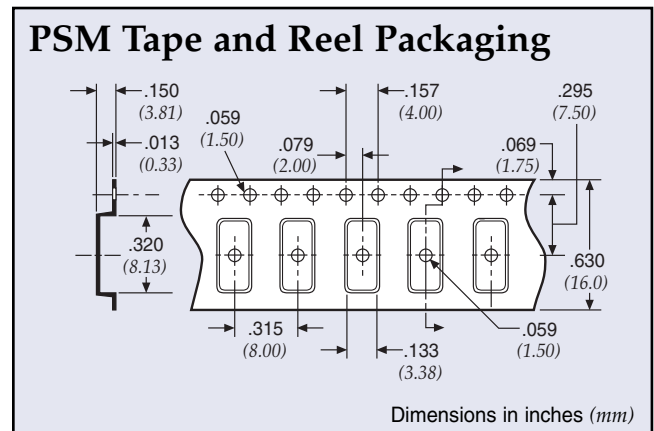

PSM Recommended Board Pattern



Mini Surface Mount Power Filters MSP Series

Features

- Designed for 10A DC power lines
- Offers high insertion loss in a wide frequency band by combining feed-through capacitors, multilayer ceramic capacitors and ferrite bead inductors with high self resonance frequency.
- Compact EMI package with plus and minus lines

Applications

- Electronic measuring instruments
- Industrial equipment
- Automotive electronics
- Switching power supplies
- DC-DC converters



Circuit Schematic



Dimensions

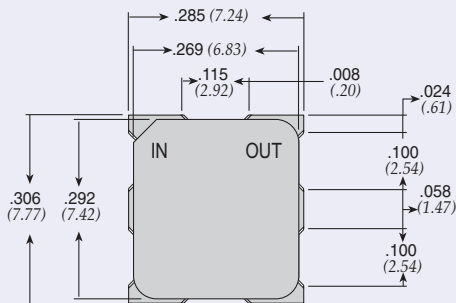

Dimensions in inches (mm)

Insertion Loss

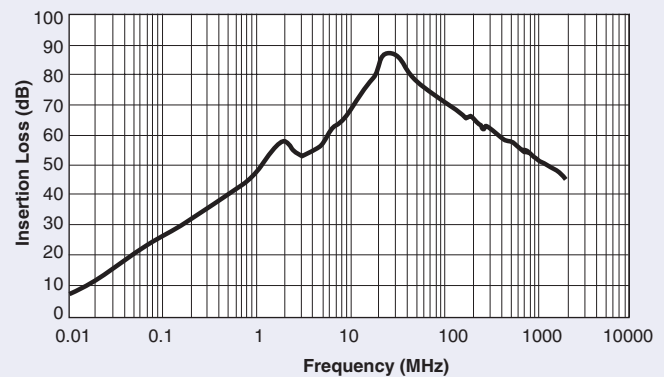

Specifications

| Model | Rated Voltage | Rated Current | Max. DCR | Temperature Range |
|-------------|---------------|---------------|----------|-------------------|
| MSP-007-050 | 50VDC | 10A | 5 MΩ | -25°C ~ +105°C |

Miniature PCB Power Filters MPC Series



Tested and found to be
IAW VDE 0565 Part 3

61-MPC Series

Rugged construction design enables parts to perform in industrial environments. The 61-MPC series is ideally suited for products that must conform to FCC part 15 regulations. Agency approvals: UL recognized, CSA certified, TUV approved (tested and found to be in accordance with VDE 0565 Part 30). Applications include:

- Personal computers and peripherals
- Measuring instruments
- Home appliances and vacuum cleaners
- Monitor and display units
- Switching power supplies
- Available lead free/RoHs compliant

11-MPC Series

Power filters are available in PCB mount, bolt-in, fast-on tab or solder lug. The 11-MPC series is ideally suited for products that have been limited board space and require a low cost alternative. Available in both metal and plastic cases. Applications include:

- Personal computers and peripherals
- Digital equipment
- Measuring instruments and medical equipment
- TV & VCR monitors and display units
- Available lead free/RoHs compliant

MPC-010/-015 Series

The compact design of the MPC-010 and -015 series power filters integrates a feed-through capacitor, multilayer ceramic capacitor and ferrite bead inductors. This series is ideally suited for dense PCB's and where both positive and negative lines have reduced EMI in one housing. Applications include:

- DC power lines on industrial equipment
- Measuring instruments
- Home appliances and vacuum cleaners
- Monitor and display units
- Switching power supplies
- Available lead free/RoHs compliant



Circuit Diagrams

Circuit 1



Circuit 2



Circuit 3



Circuit 4



Circuit 5



Miniature PCB Power Filters MPC Series

Specifications

| Model | Rated Voltage (@ 50/60Hz) | Rated Current | Leakage Current (Max.) | Inductance (L ₁) | Temperature Rise (Max.) | Circuit Diagram | Figure |
|-----------------|---------------------------|---------------|------------------------|------------------------------|-------------------------|-----------------|--------|
| 61-MPC-010-1-11 | 250VAC | 1A | 0.1mA | 11mH | 40°C | 1 | A |
| 61-MPC-016-1-11 | | 1.6A | | 6.0mH | | | |
| 61-MPC-025-1-11 | | 2.5A | | 2.4mH | | | |
| 61-MPC-036-1-11 | | 3.6A | | 1.2mH | | | |
| 11-MPC-001-2-B | 120/250VAC | 1A | 5uA | — | 30°C | 2 | C |
| 11-MPC-001-5-A | | | 3 | | | B | |
| 11-MPC-001-5-B | | | | | | C | |
| 11-MPC-002-5-B | | 2A | 4 | | | E | |
| 11-MPC-002-5-D | | | F | | | | |
| 11-MPC-003-5-E | | 3A | 3 | | | C | |
| 11-MPC-006-5-B | | | D | | | | |
| 11-MPC-006-5-C | | 6A | 4 | | | C | |
| 11-MPC-016-5-B | 16A | | 0.2mA | 4 | C | | |
| MPC-010-050 | 50 VDC | 10A | — | — | — | 5 | G |
| MPC-010-250 | 250 VDC | | | | | | |
| MPC-015-050 | 50VDC | | | | | | |

Note: Test voltage: 1500VAC one minute, line to ground. Insulation resistance: 300 MΩ min. at 500VDC. Voltage drop: 1V max. at rated current. Weight: 17.5g

Figure A



Figure B

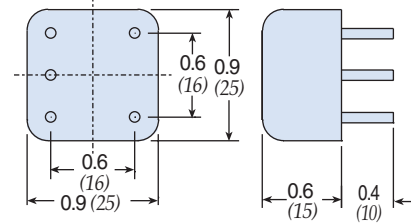

Figure C



Figure D

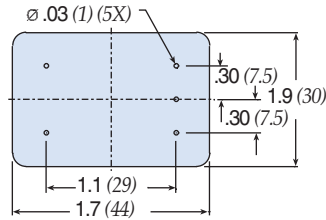

Figure E

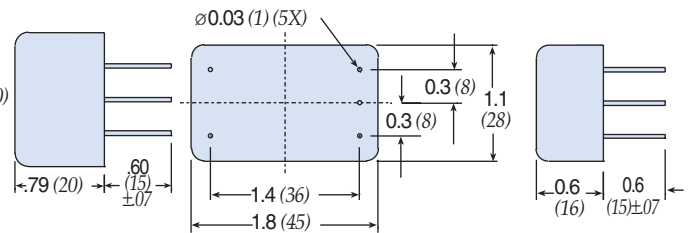

Figure F



Figure G



Dimensions in inches (mm)

Miniature PCB Power Filters MPC Series

61-MPC Series

Common Mode



61-MPC



61-MPC



Temperature Characteristics

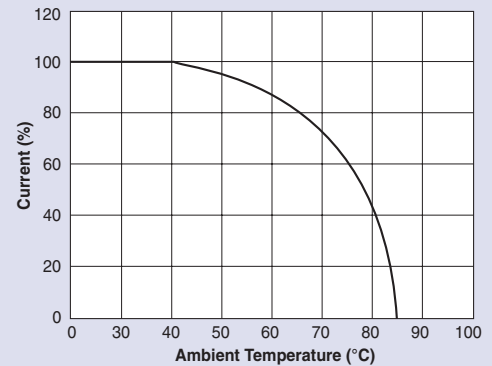

Normal Mode



61-MPC



Miniature PCB Power Filters MPC Series

11-MPC Series

Common Mode



11-MPC-001;-002



11-MPC-003;-006;-016



Normal Mode



11-MPC-001;-002



11-MPC-003;-006;-016



MPC-010 & 015 Series





Компания «ЭлектроПласт» предлагает заключение долгосрочных отношений при поставках импортных электронных компонентов на взаимовыгодных условиях!

Наши преимущества:

- Оперативные поставки широкого спектра электронных компонентов отечественного и импортного производства напрямую от производителей и с крупнейших мировых складов;
- Поставка более 17-ти миллионов наименований электронных компонентов;
- Поставка сложных, дефицитных, либо снятых с производства позиций;
- Оперативные сроки поставки под заказ (от 5 рабочих дней);
- Экспресс доставка в любую точку России;
- Техническая поддержка проекта, помощь в подборе аналогов, поставка прототипов;
- Система менеджмента качества сертифицирована по Международному стандарту ISO 9001;
- Лицензия ФСБ на осуществление работ с использованием сведений, составляющих государственную тайну;
- Поставка специализированных компонентов (Xilinx, Altera, Analog Devices, Intersil, Interpoint, Microsemi, Aeroflex, Peregrine, Syfer, Eurofarad, Texas Instrument, Miteq, Cobham, E2V, MA-COM, Hittite, Mini-Circuits, General Dynamics и др.);

Помимо этого, одним из направлений компании «ЭлектроПласт» является направление «Источники питания». Мы предлагаем Вам помощь Конструкторского отдела:

- Подбор оптимального решения, техническое обоснование при выборе компонента;
- Подбор аналогов;
- Консультации по применению компонента;
- Поставка образцов и прототипов;
- Техническая поддержка проекта;
- Защита от снятия компонента с производства.



Как с нами связаться

Телефон: 8 (812) 309 58 32 (многоканальный)

Факс: 8 (812) 320-02-42

Электронная почта: org@eplast1.ru

Адрес: 198099, г. Санкт-Петербург, ул. Калинина, дом 2, корпус 4, литера А.