

# Surface Mount EMI Filters

*our family of surface mount filters is designed to provide a range of high performance EMI filtering options with a minimal PCB footprint*



## Advantages of a Surface Mount Filter

With many years of experience in the design and manufacture of filters, API Technologies has a unique perspective on EMI and how to control it. We provide an integrated approach to EMC problems with services such as customer consulting, diagnostic testing, design and manufacturing. By offering a variety of custom assemblies, we are able to unite your specific requirements with our high performance filters.

API's Spectrum Control line of surface mount EMI filters are ideal for a wide range of PCB applications, including: automotive electronics, digital A/V equipment, computers, peripherals, telecommunications, switching power supplies and high current buss lines.

**Three Terminal Chips** offer superior ability to withstand transient voltages and surges, and deliver excellent filtering performance in high current applications while providing exceptional solderability and resistance to solder heat... **SM2-SM7**

**SA Series Arrays** incorporate four lines in one compact footprint. These arrays are nonpolar and designed to minimize residual inductance, thereby ensuring large insertion loss in a wide band and better cross talk control... **SM8-SM9**

**MSM Mini-Surface Mount** offers a multilayer electrode structure, high temperature construction and 10 Amps current ratings. The filter chips provide extreme elimination of residual inductance and the self-resonant frequency extends the microwave band... **SM11**

**SSM Square Surface Mount** square mechanical geometry enhances SMT soldering in applications up to 10 Amps. These filters come in a Pi circuit configuration and are designed to address EMI/RFI on crowded printed circuit boards... **SM12-SM13**

**PSM Power Surface Mount** are the first high temperature surface mount filter designed to effectively filter EMI/RFI at currents up to 20 Amps. These filters come in either a Feed-through or Pi circuit configuration and offer superior high frequency noise suppression... **SM14-SM15**

**MSP Mini Surface Mount Power Filters** offers a multilayer electrode structure, high temperature construction and 10 Amps current ratings. The filter chips provide extreme elimination of residual inductance and the self-resonant frequency extends to the microwave band... **SM16**

**MPC Series Miniature PCB Power Filters** are designed to fit a wide range of environments. These filters are ideal for personal computers and peripherals, home appliances, measuring instruments and medical equipment, and are all available lead free... **SM17-SM20**

**High Frequency PCB Filters** provide EMI filtering to protect low power digital circuits. With mounting directly on the printed circuit board, filtering begins at the source of the problem... **SM21**



## Surface Mount EMI Filters Three Terminal Chips

### Features

- Excellent performance in high current applications
- Non-polar, surface mountable
- Superior filtering characteristics
- Superb ability to withstand transient voltages and surge
- Offers exceptional solderability and resistance to solder heat
- Available in 0603, 0805, 1205 and 1806 body size
- Two amp current rating available
- Available lead free/RoHS Compliant

### Applications

- Cellular telephones and base stations
- Telecommunication equipment
- Industrial electronic interface or programmable controllers
- Electronic automotive equipment
- Computer and peripheral equipment



### Circuit Schematic



### Typical Electrical Characteristics

*Capacitance Range* . . . . . COG (NPO) 22 pF to 470 pF  
 X7R 470 pF to 47,000 pF  
 YV5 100,000 pF and 220,000 pF

*Capacitance Tolerance* . . . . . COG (NPO) +50/-20%  
 X7R +50/-20%  
 Y5V +80/-20%

*Temperature Coefficient* . . . . . COG (NPO) 0 ±30 ppm/°C, -55 to +125°C  
 X7R +/-15%, -55 to +125°C  
 Y5V -25 to +85°C

*Insulation Resistance* . . . . . up to 22,000 pF 10000 Megohms  
 47,000 pF 5000 Megohms

*DC Resistance* . . . . . 0.4 Amp or less 0.3 ohm max.  
 1 Amp 0.08 ohm max.  
 2 Amp 0.04 ohm max.

*Rated Voltage* . . . . . up to 100 VDC

*Rated Current* . . . . . up to 2 Amps

## Surface Mount EMI Filters Three Terminal Chips

### Selection Guide

Part Number	Body Size	Capacitance (in picofarad)	Capacitance Tolerance	Temp. Charact.	Rated Voltage (Volts DC)	Rated Current (Amps DC)	IR (Megohms Min.)	DC Resistance (ohm Max.)	Operating Temp.
SF0603C220SBNB-*	0603	22	+50/-20%	COG	50	0.3	10,000	0.3	-55/+125°C
SF0603C470SBNB-*	0603	47	+50/-20%	COG	50	0.3	10,000	0.3	-55/+125°C
SF0603C101SBNB-*	0603	100	+50/-20%	COG	50	0.3	10,000	0.3	-55/+125°C
SF0603C221SBNB-*	0603	220	+50/-20%	COG	50	0.3	10,000	0.3	-55/+125°C
SF0603X471SBNB-*	0603	470	+50/-20%	X7R	50	0.3	10,000	0.3	-55/+125°C
SF0603X102SBNB-*	0603	1,000	+50/-20%	X7R	50	0.3	10,000	0.3	-55/+125°C
SF0603X222SBNB-*	0603	2,200	+50/-20%	X7R	50	0.3	10,000	0.3	-55/+125°C
SF0603X223SANC-*	0603	22,000	+50/-20%	X7R	25	0.5	10,000	0.15	-55/+125°C
<b>SF0603Y104MAND-*</b>	<b>0603</b>	<b>100,000</b>	<b>±20%</b>	<b>Y5V†</b>	<b>25</b>	<b>1</b>	<b>1,000</b>	<b>0.08</b>	<b>-25/+85°C</b>
SF0805C220SBNC-*	0805	22	+50/-20%	COG	50	0.4	10,000	0.3	-55/+125°C
SF0805C470SBNC-*	0805	47	+50/-20%	COG	50	0.4	10,000	0.3	-55/+125°C
SF0805C101SBNC-*	0805	100	+50/-20%	COG	50	0.4	10,000	0.3	-55/+125°C
SF0805C221SBNC-*	0805	220	+50/-20%	COG	50	0.4	10,000	0.3	-55/+125°C
SF0805X471SBNC-*	0805	470	+50/-20%	X7R	50	0.4	10,000	0.3	-55/+125°C
SF0805X102SBNC-*	0805	1,000	+50/-20%	X7R	50	0.4	10,000	0.3	-55/+125°C
SF0805X222SBNC-*	0805	2,200	+50/-20%	X7R	50	0.4	10,000	0.3	-55/+125°C
<b>SF0805X223SBND-*</b>	<b>0805</b>	<b>22,000</b>	<b>+50/-20%</b>	<b>X7R</b>	<b>50</b>	<b>1.0</b>	<b>10,000</b>	<b>0.08</b>	<b>-55/+125°C</b>
SF1205C220SBNB-*	1205	22	+50/-20%	COG	50	0.3	10,000	0.3	-55/+125°C
SF1205C470SBNB-*	1205	47	+50/-20%	COG	50	0.3	10,000	0.3	-55/+125°C
SF1205C101SBNB-*	1205	100	+50/-20%	COG	50	0.3	10,000	0.3	-55/+125°C
SF1205C221SBNB-*	1205	220	+50/-20%	COG	50	0.3	10,000	0.3	-55/+125°C
SF1205X471SBNB-*	1205	470	+50/-20%	X7R	50	0.3	10,000	0.3	-55/+125°C
SF1205X102SBNB-*	1205	1,000	+50/-20%	X7R	50	0.3	10,000	0.3	-55/+125°C
SF1205X222SBNB-*	1205	2,200	+50/-20%	X7R	50	0.3	10,000	0.3	-55/+125°C
SF1205X223SBNB-*	1205	22,000	+50/-20%	X7R	50	0.3	10,000	0.3	-55/+125°C
<b>SF1205X473SBND-*</b>	<b>1205</b>	<b>47,000</b>	<b>+50/-20%</b>	<b>X7R</b>	<b>50</b>	<b>1.0</b>	<b>5,000</b>	<b>0.08</b>	<b>-55/+125°C</b>
SF1806C220SDNB-*	1806	22	+50/-20%	COG	100	0.3	10,000	0.3	-55/+125°C
SF1806C470SDNB-*	1806	47	+50/-20%	COG	100	0.3	10,000	0.3	-55/+125°C
SF1806C101SDNB-*	1806	100	+50/-20%	COG	100	0.3	10,000	0.3	-55/+125°C
SF1806C221SDNB-*	1806	220	+50/-20%	COG	100	0.3	10,000	0.3	-55/+125°C
SF1806C471SDNB-*	1806	470	+50/-20%	COG	100	0.3	10,000	0.3	-55/+125°C
SF1806X102SDNB-*	1806	1,000	+50/-20%	X7R	100	0.3	10,000	0.3	-55/+125°C
SF1806X222SDNB-*	1806	2,200	+50/-20%	X7R	100	0.3	10,000	0.3	-55/+125°C
SF1806X103SDNB-*	1806	10,000	+50/-20%	X7R	100	0.3	10,000	0.3	-55/+125°C
SF1806X223SDNB-*	1806	22,000	+50/-20%	X7R	100	0.3	10,000	0.3	-55/+125°C
<b>2 AMP FILTER SF1806Y224ZBNE-*</b>	<b>1806</b>	<b>220,000</b>	<b>+80/-20%</b>	<b>Y5V†</b>	<b>50</b>	<b>2.0</b>	<b>1,000</b>	<b>0.04</b>	<b>-25/+85°C</b>

Bold Letter = High Current Applications  
† = Temperature Characteristic is +30/-80%

\* = Denotes Packaging Style. Replace with T for Tape and Reel or B for Bulk

# Surface Mount EMI Filters Three Terminal Chips

## Insertion Loss (Per MIL-STD-220)

### SF0603 Series



### SF0805 Series



### SF1205 Series

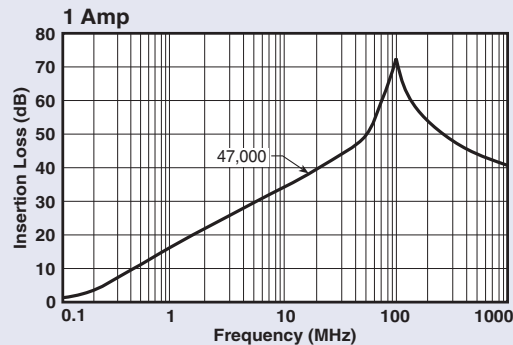

### SF1806 Series

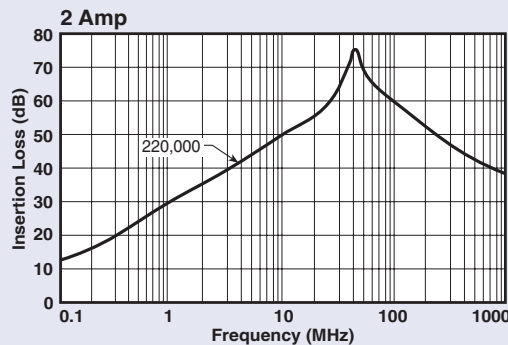

## Surface Mount EMI Filters Three Terminal Chips



### Mechanical Dimensions

Dimensions in inches (mm)

Body Style/Size	Body Length (L)	Body Width (W)	Body Thickness (T)	End Terminal Length (LE)	Middle Terminal Length (LM)
SF0603	0.063 +/-0.006 (1.60 +/-0.15)	0.031 +/-0.006 (0.80 +/-0.15)	0.023 +/-0.006 (0.6 +/-0.15)	0.008 +/-0.006 (0.2 +/-0.15)	0.020 +/-0.006 (0.5 +/-0.15)
SF0805	0.079 +/-0.008 (2.0 +/-0.2)	0.049 +/-0.008 (1.25 +/-0.2)	0.032 +/-0.008 (0.8 +/-0.2)	0.012 +/-0.008 (0.3 +/-0.2)	0.024 +/-0.008 (0.6 +/-0.2)
SF1205	0.126 +/-0.008 (3.2 +/-0.2)	0.049 +/-0.008 (1.25 +/-0.2)	0.028 +/-0.008 (0.7 +/-0.2)	0.016 +/-0.012 (0.4 +/-0.3)	0.043 +/-0.012 (1.1 +/-0.3)
SF1806	0.177 +/-0.012 (4.5 +/-0.3)	0.063 +/-0.012 (1.6 +/-0.3)	0.039 +/-0.012 (1.0 +/-0.3)	0.020 +/-0.012 (0.5 +/-0.3)	0.055 +/-0.012 (1.4 +/-0.3)

### Ordering Information

Example: **SF0805C221SBNCT**

This part number represents a three terminal chip with a body size of 0805 with a COG (NPO) dielectric. The capacitance is 220 pF with a capacitance tolerance of +50%/-20%. Voltage rating is 50 Volts DC. It has nickel barrier, solder plated terminations and a current rating of 0.4 Amp, (400 milliamps). The parts are taped and reeled.

SF	0805	C	221	S	B	N	C	T
Style	Size	Ceramic	Capacitance Code	Capacitance Tolerance	Rated Voltage (Vdc)	Termination	Current Rating	Packaging
SF	0603 0805 1205 1806	C - COG X - X7R Y - Y5V	First two numbers are significant, the third number refers to number of zeroes	S - +50%/-20% Z - +80%/-20%	A - 25 B - 50 D - 100	N - Ni Barrier, Solder Plated	B - 0.3 A C - 0.4 A D - 1 A E - 2 A F - 3 A G - 4 A H - 5 A I - 6 A	T - Tape & Reel B - Bulk

# Surface Mount EMI Filters Three Terminal Chips Soldering Specifications

## Soldering Instructions

### Reflow Soldering



Board Pattern Dimensions in inches (mm)

Body Style/Size	Dimension		
	A	B	C
SF0603	0.020 (0.5)	0.047 (1.2)	0.031 (0.8)
SF0805	0.024 (0.6)	0.059 (1.5)	0.039 (1.0)
SF1205	0.051 (1.3)	0.091 (2.3)	0.047 (1.2)
SF1806	0.079 (2.0)	0.138 (3.5)	0.051 (1.3)

### Reflow Soldering



## General Soldering Notes

1. High soldering temperatures and long soldering times can cause leaching of the termination and adversely affect adhesion. These conditions can also decrease capacitance value. Use the above recommended solder temperature cycle.
2. Due to the mechanical characteristic of ceramic composition, aggressive thermal shock will degrade performance. Preheat the assembly before soldering using the above solder temperature profile as a guide.

### Flow Soldering



Board Pattern Dimensions in inches (mm)

Body Style/Size	Dimension					
	A	B	C	D	E	F
SF0603	0.020 (0.5)	0.031 (0.8)	0.047 (1.2)	0.031 (0.8)	0.071 (1.8)	0.016 (0.4)
SF0805	0.024 (0.6)	0.031 (0.8)	0.059 (1.5)	0.039 (1.0)	0.087 (2.2)	0.024 (0.6)
SF1205	0.051 (1.3)	0.059 (1.5)	0.091 (2.3)	0.047 (1.2)	0.118 (3.0)	0.024 (0.6)
SF1806	0.059 (1.5)	0.079 (1.5)	0.138 (3.5)	0.051 (1.3)	0.118 (3.0)	0.024 (0.6)

### Flow Soldering



3. Use mild flux (less than 0.2% by weight of Chlorine), preferable rosin based. If water soluble, wash thoroughly to assure all residue is removed from the underside of components.
4. Ultrasonic Cleaning  
When using an ultrasonic cleaning method, the following range is recommended:  
Frequency: Not to exceed 28kHz  
Output Power: Not to exceed 20W/liter  
Cleaning Time: 5 minutes max

Surface Mount EMI Filters  
**Three Terminal Chips**  
**Soldering Specifications**

**Package Quantities**

Body Style/Size	Tape and Reel
SF0603	4,000 units/reel
SF0805	4,000 units/reel
SF1205	4,000 units/reel
SF1806	2,000 units/reel

**Package Information**  
**Paper Tape Dimensions**  
**SF0805 and SF1205 Bodies**



Dimensions in inches (mm)

Body Style/Size	Chip Cavity		Tape			Holes			Hole Diameter		Thickness	
	Length A	Width B	Width W	Center to End F	Indexing to End E	Center to Center C	Indexing to Center C1	Indexing to Indexing C2	Indexing D1	Overall T (Max.)	Carrier Tape T1 (Max.)	
SF0603	0.039 +/-0.00? (1.0 +/-0.?)	0.075 +/-0.00? (1.9 +/-0.?)	0.315 +/-0.012 (8.0 +/-0.3)	0.138 +/-0.002 (3.5 +/-0.05)	0.069 +/-0.004 (1.75 +/-0.1)	0.157 +/-0.004 (4.0 +/-0.1)	0.079 +/-0.004 (2.0 +/-0.1)	0.157 +/-0.008 (4.0 +/-0.1)	0.059 +0.004/-0 (1.5 +0.1/-0)	0.043 (1.1)	0.039 (1.0)	
SF0805	0.064 +/-0.008 (1.62 +/-0.2)	0.091 +/-0.008 (2.3 +/-0.2)	0.315 +/-0.012 (8.0 +/-0.3)	0.138 +/-0.002 (3.5 +/-0.05)	0.069 +/-0.004 (1.75 +/-0.1)	0.157 +/-0.004 (4.0 +/-0.1)	0.079 +/-0.004 (2.0 +/-0.1)	0.157 +/-0.008 (4.0 +/-0.1)	0.059 +0.004/-0 (1.5 +0.1/-0)	0.043 (1.1)	0.039 (1.0)	
SF1205	0.067 +/-0.008 (1.70 +/-0.2)	0.138 +/-0.008 (3.5 +/-0.2)	0.315 +/-0.012 (8.0 +/-0.3)	0.138 +/-0.002 (3.5 +/-0.05)	0.069 +/-0.004 (1.75 +/-0.1)	0.157 +/-0.004 (4.0 +/-0.1)	0.079 +/-0.004 (2.0 +/-0.1)	0.157 +/-0.008 (4.0 +/-0.1)	0.059 +0.004/-0 (1.5 +0.1/-0)	0.043 (1.1)	0.039 (1.0)	

**Plastic Reel Dimensions**

Dimensions in inches (mm)

Body Style/Size	Diameter (Max.)	Width (Max.)
SF0603	7.00 (180)	0.46 (11.5)
SF0805	7.00 (180)	0.46 (11.5)
SF1205	7.00 (180)	0.46 (11.5)
SF1806	7.00 (180)	0.61 (11.5)

**Package Information**  
**Tape and Reel Specification**  
**Plastic Carrier Tape Dimensions**  
**SF1806 Body**

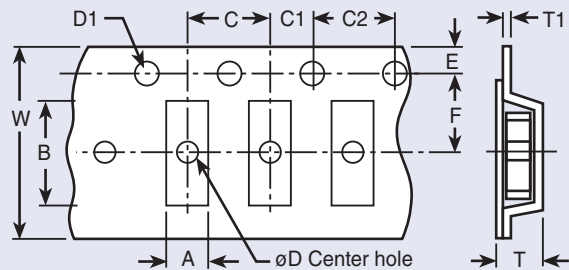

Dimensions in inches (mm)

Body Style/Size	Chip Cavity		Tape			Holes			Hole Diameter		Thickness	
	Length A	Width B	Width W	Center to End F	Indexing to End E	Center to Center C	Indexing to Center C1	Indexing to Indexing C2	Center D (Min.)	Indexing D1	Overall T (Max.)	Tape T1 (Max.)
SF1806	0.071 +/-0.008 (1.80 +/-0.2)	0.185 +/-0.008 (4.70 +/-0.2)	0.472 +/-0.008 (12.0 +/-0.2)	0.217 +/-0.002 (5.5 +/-0.05)	0.069 +/-0.004 (1.75 +/-0.1)	0.157 +/-0.004 (4.0 +/-0.1)	0.079 +/-0.004 (2.0 +/-0.1)	0.157 +/-0.008 (4.0 +/-0.1)	0.059 (1.5)	0.059 +0.004/-0 (1.5 +0.1/-0)	0.098 (2.5)	0.024 (0.6)

## Surface Mount Filter Arrays SA Series

### Features

- The filter's structure minimizes residual inductance with a high self resonant frequency, ensuring large insertion loss in a wide band.
- The common ground electrode built into the chip ensures complete grounding of all lines at the ground on both ends. The filter is designed to control cross talk.
- An optimum constant can be selected from the capacity range of 22-22,000 pF to best suit the frequency.
- Solder plated nickel barrier terminations offer good solderability and resistance to soldering heat.
- Available lead free/RoHs compliant

### Applications

- Noise reduction for DC lines on computers
- Computer peripheral equipment
- Digital TV & VTR
- Cellular telephones
- Automotive electronics

### Typical Electrical Characteristics

Rated Voltage . . . . . 25 VDC to 50 VDC

Rated Current . . . . . 0.3 Amps

IR . . . . . 10,000 MΩ Min.

DC Resistance . . . . . 0.3 Ω Max.

Temperature Range . . . . . -55°C to +125°C

Capacitance Range . . . . . 22 pF to 22,000 pF

Capacitance Tolerance . . . . . ±20%

### Specifications

Part Number	Rated Voltage (@ 50/60Hz)	Rated Current	Temperature Characteristic	IR	DC Resistance	Operating Temp	Capacitance (pF)
SA1206C220	50 VDC	0.3A DC	C	10,000 MΩ min.	0.3Ω max.	-55/+125°C	22
SA1206C470			C				47
SA1206C101			C				100
SA1206C221			C				220
SA1206R471			U				470
SA1206R102			R				1,000
SA1206R222			R				2,200
SA1206R223	25 VDC		R				22,000



### Circuit Schematic





## Surface Mount Filter Arrays SA Series

### Ordering Information

<b>SA</b>	<b>1206</b>	<b>C</b>	<b>220</b>	<b>M</b>	<b>B</b>	<b>N</b>	<b>B</b>
Style	Size	Temperature Characteristics	Capacitance	Capacitance tolerance	Rated Voltage (Vdc)	Termination	Packaging
SA Series	1206	<b>C</b> +/- 30 ppm/°C <b>R</b> +/- 15% <b>U</b> -750 +/- 120 ppm/°C	22 pF 47 pF 100 pF 220 pF 470 pF 1,000 pF 2,200 pF 22,000 pF	<b>M</b> = ± 20%	<b>A</b> = 25 <b>B</b> = 50	<b>N</b> = Ni Barrier Solder Plated	<b>T</b> - Tape and reel 4,000 pc/reel <b>B</b> - Bulk pack 1,000 pcs/bag

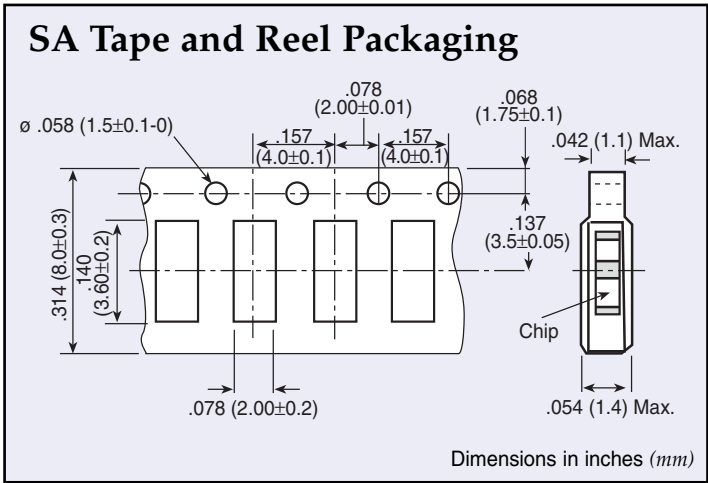

### Recommended Board Pattern

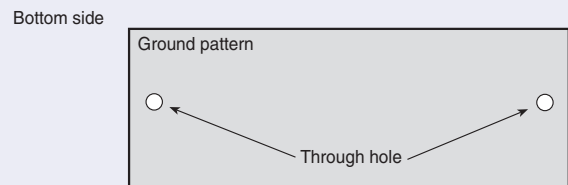
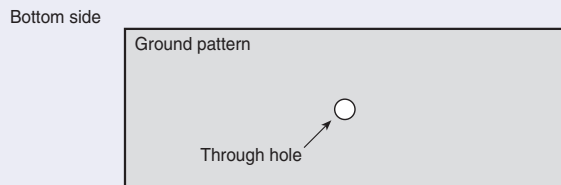
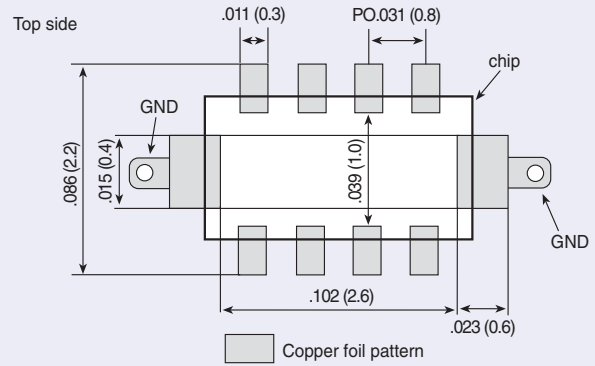
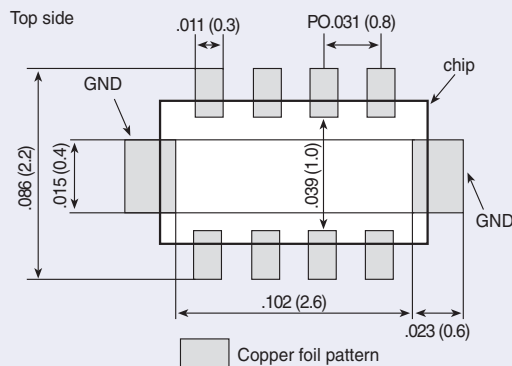

Dimensions in inches (mm)

## Surface Mount Low Pass Filters MSM, SSM, RSM & PSM Series

### MSM - Miniature Surface Mount Chip Capacitors



The MSM series filters feature high temperature construction and have current ratings up to 10 Amps. The filter chips will hardly allow residual inductance and the self-resonant frequency extends to the microwave band. Applications include telecommunication equipment, computer and peripheral equipment and digital AV equipment, medical equipment, DC power supply lines.

- Miniature footprint help in dense circuit configuration
- Rated at 10 Amps
- Packaged in tape and reel or bulk form
- Operating temperature ranges of -25°C to +85°C and -55°C to +125°C
- Available lead free/RoHs compliant

### SSM - Square Surface Mount Filters



The SSM series filters feature high temperature construction and have current ratings up to 10 Amps. This filter chip series is nonpolar and surface mountable with excellent performance characteristics and comes in a Pi circuit configuration. Applications include telecommunication equipment, computer and peripheral equipment, digital AV equipment, power amplifiers, power supplies and high current bus lines.

- Square mechanical geometry enhances SMT soldering
- Rated to 10 Amps
- Packaged in tape and reel or bulk form
- Operating temperature range of -55°C to +125°C
- Available lead free/RoHs compliant

### RSM - Round Surface Mount Filters



The RSM series filters feature high temperature construction and have current ratings up to 10 Amps. This filter chip series is nonpolar and surface mountable with excellent performance characteristics and comes in a Pi circuit configuration. Applications include telecommunication equipment, computer and peripheral equipment, digital AV equipment, power amplifiers, power supplies and high current bus lines.

- Round mechanical geometry enhances SMT soldering
- Rated to 10 Amps
- Packaged in tape and reel or bulk form
- Operating temperature range of -55°C to +125°C
- Available lead free/RoHs compliant

### PSM - Power Surface Mount Filters



The PSM series filters feature high temperature construction and have current ratings up to 20 Amps. This filter series is nonpolar and surface mountable with excellent performance characteristics and comes in either a Feed-through or Pi circuit configuration. Applications include telecommunication equipment, computer and peripheral equipment, digital AV equipment, power amplifiers, power supplies and high current bus lines.

- Provides time and costs saving compared to through-hole filters
- Rated to 20 Amps
- Packaged in tape and reel or bulk form
- Operating temperature range of -55°C to +125°C
- Available lead free/RoHs compliant

## Surface Mount Low Pass Filters MSM Series

### MSM



Working Voltage ..... 50 VDC  
 Test Voltage ..... 150 VDC  
 Current Rating ..... 10 Amps max.  
 Insulation Resistance ..... 1.0 MΩ  
 Terminations ..... Ni-Barrier  
 Soldering Conditions ..... Max. 250°C-5 sec.

### Insertion Loss



### MSM

Dimensions in inches (mm)

### MSM Ordering Information

**MSM**

Style

MSM  
(Miniature)

**4**

Circuit  
Configuration  
4 - Feed-Through

**T**

Temperature  
Characteristic  
R - +/-15%  
T - +22/-33%  
V - +22/-82%

**470M**

Capacitance

Value	Tolerance
47 pF	+50/- 20%

**10**

Current  
Rating  
10 Amps

**T**

Packaging

T - Tape and Reel  
2,000 pcs/reel  
B - Bulk pack  
1,000pcs/reel

### Specifications

Part Number	Temperature Characteristics	Capacitance	Capacitance Tolerance	Current Rating	Rated Rating	Temperature Range
MSM4T470M10	T	47pF	+50/-20%	10A	50VDC	-55/+125°C
MSM4R151M10	R	150pF				-55/+125°C
MSM4R271M10	R	270pF				-55/+125°C
MSM4V102M10	V	1000pF				-25/+85°C

### MSM Recommended Board Pattern



Note: Exclusively for reflow soldering

### MSM Tape and Reel Packaging



Dimensions in inches (mm)

## Surface Mount Low Pass Filters SSM & RSM Series

### SSM



- Working Voltage . . . . . 100 VDC
- Test Voltage . . . . . 250 VDC
- Current . . . . . Max. 10 Amps
- Insulation Resistance . . . . . Min.  $10^4$  M $\Omega$
- Terminations . . . . . Silver Ni-Tin plated
- Soldering Conditions . . . . . Max. 250°C -5 sec.
- Marking . . . . . None
- Packaging . . . . . Bulk or tape and reel

**Note:** Insertion loss shown for the following SSM values\* only:

- 101Z
- 501P
- 202P

\*Additional IL charts available by request.

### RSM



- Working Voltage . . . . . 100 VDC
- Test Voltage . . . . . 250 VDC
- Current . . . . . Max. 10 Amps
- Insulation Resistance . . . . . Min.  $10^4$  M $\Omega$
- Terminations . . . . . Silver Ni-Tin plated
- Soldering Conditions . . . . . Max. 250°C -5 sec.
- Marking . . . . . None
- Packaging . . . . . Bulk or tape and reel

**Note:** Insertion loss shown for the following RSM values only:

- 152P
- 402Z

## Pi Insertion Loss

### Typical SMT Applications



### Shielded or Partition Applications



\* Capacitance values for insertion loss curves are displayed left to right in the order shown.

### SSM



### RSM



Dimensions in inches (mm)

## Surface Mount Low Pass Filters SSM & RSM Series

### SSM & RSM Ordering Information

Example: **SSM1-101Z-05T 1**

<b>SSM</b>	<b>1</b>	<b>-</b>	<b>101Z</b>	<b>-</b>	<b>05</b>	<b>T</b>	<b>1</b>																					
<b>Style</b>	<b>Circuit Configuration</b>		<b>Capacitance</b>		<b>Current Rating</b>	<b>Packaging</b>	<b>Tape and Reel</b>																					
SSM (Square) RSM (Round)	1 - Pi				05 - 5 Amps 10 - 10 Amps	T - Tape and reel packaging B - Bulk packaging	1 - 1,000 pieces 6 - 6,000 pieces <i>Note: Tape and reel packaging - 1,000 pieces (7") and 6,000 pieces (13")</i>																					
			<table border="1" style="width: 100%; border-collapse: collapse;"> <thead> <tr> <th>Code</th> <th>Value</th> <th>Tolerance</th> </tr> </thead> <tbody> <tr> <td>101Z</td> <td>100 pF</td> <td>+80/-20%</td> </tr> <tr> <td>501P</td> <td>500 pF</td> <td>+100/-0%</td> </tr> <tr> <td>152P</td> <td>1500 pF</td> <td>+100/-0%</td> </tr> <tr> <td>202P</td> <td>2000 pF</td> <td>+100/-0%</td> </tr> <tr> <td>402E</td> <td>4000 pF</td> <td>±25</td> </tr> <tr> <td>402Z</td> <td>4000 pF</td> <td>+80/-20%</td> </tr> </tbody> </table>	Code	Value	Tolerance	101Z	100 pF	+80/-20%	501P	500 pF	+100/-0%	152P	1500 pF	+100/-0%	202P	2000 pF	+100/-0%	402E	4000 pF	±25	402Z	4000 pF	+80/-20%				
Code	Value	Tolerance																										
101Z	100 pF	+80/-20%																										
501P	500 pF	+100/-0%																										
152P	1500 pF	+100/-0%																										
202P	2000 pF	+100/-0%																										
402E	4000 pF	±25																										
402Z	4000 pF	+80/-20%																										

† Also available through API's authorized distributors.  
 € Also available through API's authorized European distributors/agents.  
 † SSM1-152P-05-T1 €



## Surface Mount Low Pass Filters PSM Series

### PSM

### Feed-Through

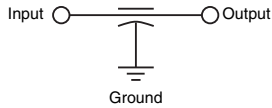

### Pi

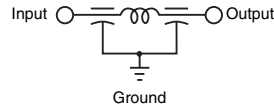

- Voltage Rating DC . . . . . 200 VDC @ -55°C to +125°C  
 DWV . . . . . 700 VDC  
 Current Rating . . . . . 20 Amps (Feed-through) max.  
 . . . . . 10 Amps (Pi) max.  
 Insulation Resistance . . . . . 1.0 GΩ @ 25°C  
 Dissipation Factor . . . . . 4.0% maximum  
 D.C.R. . . . . Max. .0005Ω, typ. .0002Ω

\* AC rated parts available. Please consult factory.

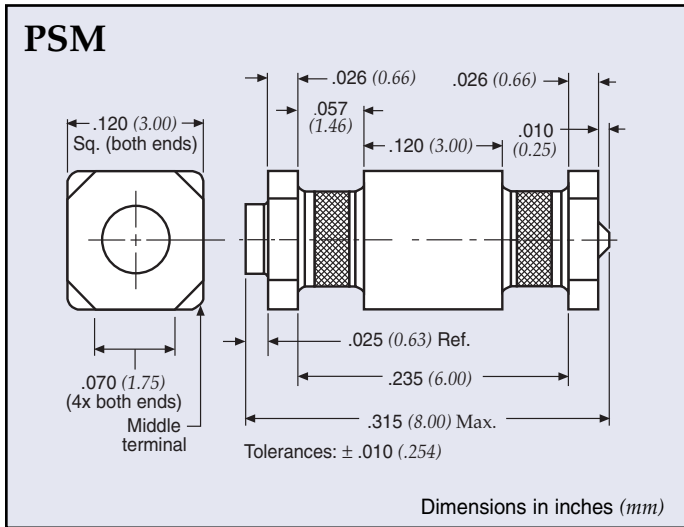

## Feed-Through Insertion Loss

### Typical SMT Applications

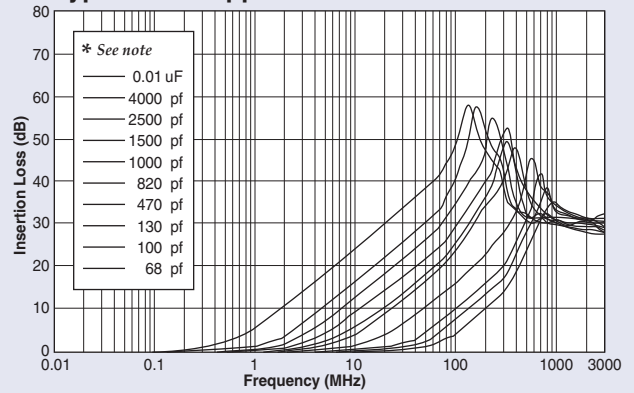

### Shielded or Partition Applications

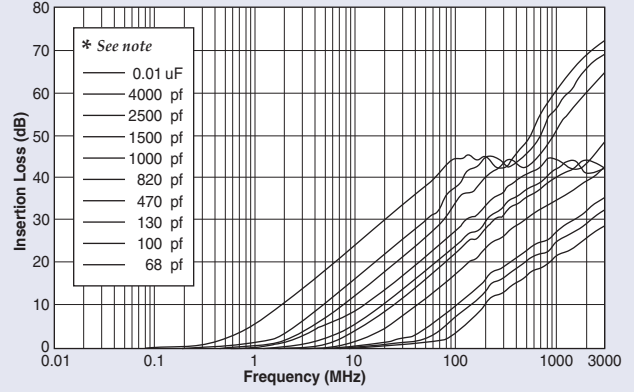

\* Capacitance values for insertion loss curves are displayed left to right in the order shown.

## Pi Insertion Loss

### Typical SMT Applications

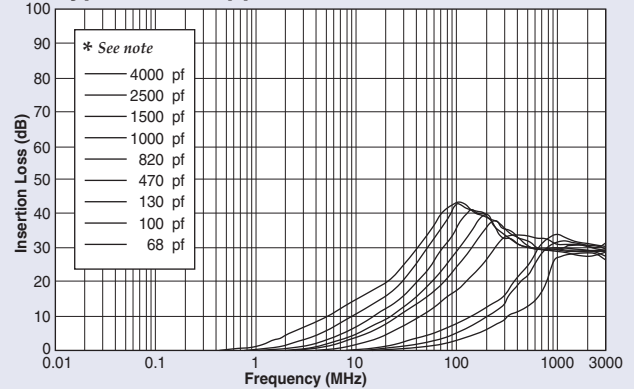

### Shielded or Partition Applications

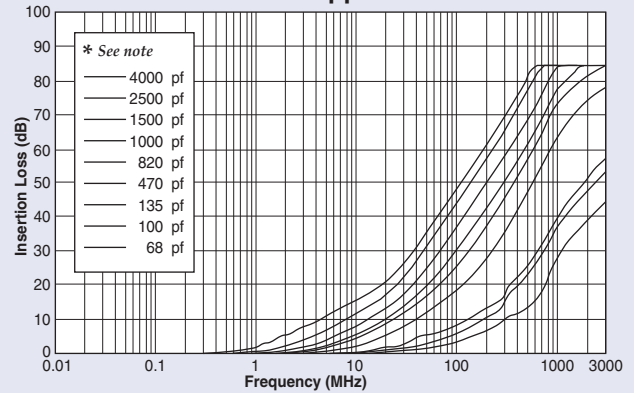

## Surface Mount Low Pass Filters PSM Series

### PSM Ordering Information

Example: **PSM4-402Z-20T0**

<b>PSM</b>	<b>4</b>	<b>402Z</b>	<b>20</b>	<b>T</b>	<b>0</b>																																
Style	Circuit Configuration	Capacitance	Current Rating	Packaging	Tape and Reel																																
PSM (Power)	1 - Pi 4 - Feed-through		10 - 10 Amps (Pi) 20 - 20 Amps (Feed-through)	T - Tape and reel packaging B - Bulk packaging	0 - 500 pieces 2 - 2,000 pieces <i>Note: Tape and reel packaging - 500 pieces (7") and 2,000 pieces (13")</i>																																
† Also available through API's authorized distributors.		<table border="1"> <thead> <tr> <th>Code</th> <th>Value*</th> <th>Tolerance</th> </tr> </thead> <tbody> <tr><td>680M</td><td>68 pF</td><td>±20%</td></tr> <tr><td>101M</td><td>100 pF</td><td>±20%</td></tr> <tr><td>131P</td><td>130 pF</td><td>+100/-0%</td></tr> <tr><td>471P</td><td>470 pF</td><td>+100/-0%</td></tr> <tr><td>821M</td><td>820 pF</td><td>±20%</td></tr> <tr><td>102M</td><td>1000 pF</td><td>±20%</td></tr> <tr><td>152M</td><td>1500 pF</td><td>±20%</td></tr> <tr><td>252P</td><td>2500 pF</td><td>+100/-0%</td></tr> <tr><td>402Z</td><td>4000 pF</td><td>+80/20%</td></tr> <tr><td>103Z**</td><td>.01 μF</td><td>+80/-20%</td></tr> </tbody> </table>	Code	Value*	Tolerance	680M	68 pF	±20%	101M	100 pF	±20%	131P	130 pF	+100/-0%	471P	470 pF	+100/-0%	821M	820 pF	±20%	102M	1000 pF	±20%	152M	1500 pF	±20%	252P	2500 pF	+100/-0%	402Z	4000 pF	+80/20%	103Z**	.01 μF	+80/-20%	* Other capacitance values available as special order. ** Available in Feed-through circuit only.	
Code	Value*	Tolerance																																			
680M	68 pF	±20%																																			
101M	100 pF	±20%																																			
131P	130 pF	+100/-0%																																			
471P	470 pF	+100/-0%																																			
821M	820 pF	±20%																																			
102M	1000 pF	±20%																																			
152M	1500 pF	±20%																																			
252P	2500 pF	+100/-0%																																			
402Z	4000 pF	+80/20%																																			
103Z**	.01 μF	+80/-20%																																			

### Technical Notes

- Soldering recommendations supplied upon request
- Reflow temperature limit is 250°C
- Unit weight is approximately 0.4 grams
- Tape and reel packaging available for automated assembly

### PSM Tape and Reel Packaging



### PSM Recommended Board Pattern



## Mini Surface Mount Power Filters MSP Series

### Features

- Designed for 10A DC power lines
- Offers high insertion loss in a wide frequency band by combining feed-through capacitors, multilayer ceramic capacitors and ferrite bead inductors with high self resonance frequency.
- Compact EMI package with plus and minus lines

### Applications

- Electronic measuring instruments
- Industrial equipment
- Automotive electronics
- Switching power supplies
- DC-DC converters



### Circuit Schematic



### Dimensions



Dimensions in inches (mm)

### Insertion Loss



### Specifications

Model	Rated Voltage	Rated Current	Max. DCR	Temperature Range
MSP-007-050	50VDC	10A	5 MΩ	-25°C ~ +105°C



## Miniature PCB Power Filters MPC Series



Tested and found to be  
IAW VDE 0565 Part 3

### 61-MPC Series

Rugged construction design enables parts to perform in industrial environments. The 61-MPC series is ideally suited for products that must conform to FCC part 15 regulations. Agency approvals: UL recognized, CSA certified, TUV approved (tested and found to be in accordance with VDE 0565 Part 30). Applications include:

- Personal computers and peripherals
- Measuring instruments
- Home appliances and vacuum cleaners
- Monitor and display units
- Switching power supplies
- Available lead free/RoHs compliant

### 11-MPC Series

Power filters are available in PCB mount, bolt-in, fast-on tab or solder lug. The 11-MPC series is ideally suited for products that have been limited board space and require a low cost alternative. Available in both metal and plastic cases. Applications include:

- Personal computers and peripherals
- Digital equipment
- Measuring instruments and medical equipment
- TV & VCR monitors and display units
- Available lead free/RoHs compliant

### MPC-010/-015 Series

The compact design of the MPC-010 and -015 series power filters integrates a feed-through capacitor, multilayer ceramic capacitor and ferrite bead inductors. This series is ideally suited for dense PCB's and where both positive and negative lines have reduced EMI in one housing. Applications include:

- DC power lines on industrial equipment
- Measuring instruments
- Home appliances and vacuum cleaners
- Monitor and display units
- Switching power supplies
- Available lead free/RoHs compliant



## Circuit Diagrams

**Circuit 1**

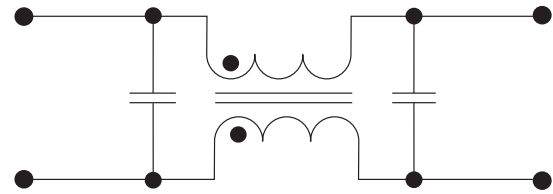

**Circuit 2**

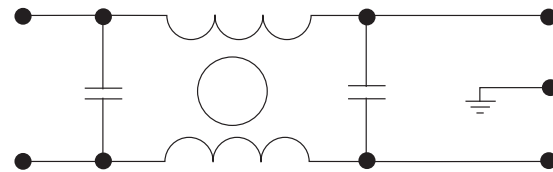

**Circuit 3**

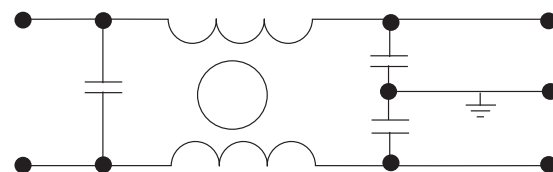

**Circuit 4**

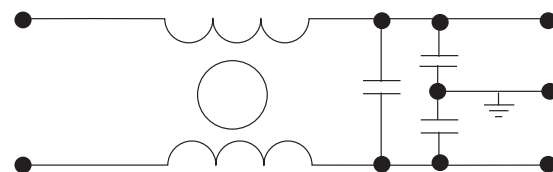

**Circuit 5**

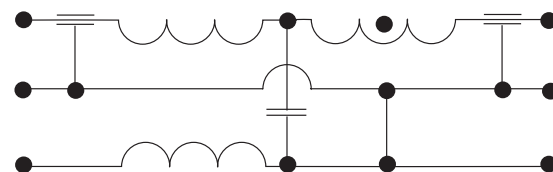

# Miniature PCB Power Filters MPC Series

## Specifications

Model	Rated Voltage (@ 50/60Hz)	Rated Current	Leakage Current (Max.)	Inductance (L <sub>1</sub> )	Temperature Rise (Max.)	Circuit Diagram	Figure
61-MPC-010-1-11	250VAC	1A	0.1mA	11mH	40°C	1	A
61-MPC-016-1-11		1.6A		6.0mH			
61-MPC-025-1-11		2.5A		2.4mH			
61-MPC-036-1-11		3.6A		1.2mH			
11-MPC-001-2-B	120/250VAC	1A	5uA	—	30°C	2	C
11-MPC-001-5-A			3			B	
11-MPC-001-5-B						C	
11-MPC-002-5-B		2A	4			E	
11-MPC-002-5-D			F				
11-MPC-003-5-E		3A	3			C	
11-MPC-006-5-B			D				
11-MPC-006-5-C		6A	4			C	
11-MPC-016-5-B	16A		0.2mA	4	C		
MPC-010-050	50 VDC	10A	—	—	—	5	G
MPC-010-250	250 VDC						
MPC-015-050	50VDC						

Note: Test voltage: 1500VAC one minute, line to ground. Insulation resistance: 300 MΩ min. at 500VDC. Voltage drop: 1V max. at rated current. Weight: 17.5g

**Figure A**

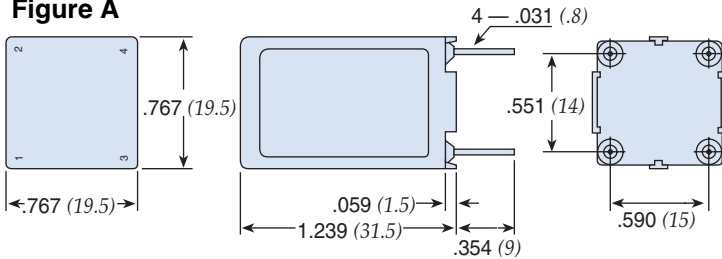

**Figure B**



**Figure C**



**Figure D**

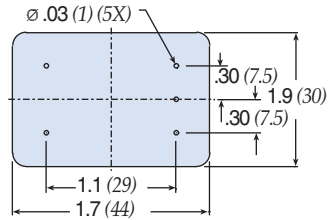

**Figure E**



**Figure F**



**Figure G**



Dimensions in inches (mm)

# Miniature PCB Power Filters MPC Series

## 61-MPC Series

### Common Mode



#### 61-MPC



#### 61-MPC



### Temperature Characteristics



### Normal Mode



#### 61-MPC



# Miniature PCB Power Filters MPC Series

## 11-MPC Series

### Common Mode

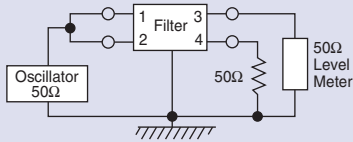

#### 11-MPC-001;-002



#### 11-MPC-003;-006;-016

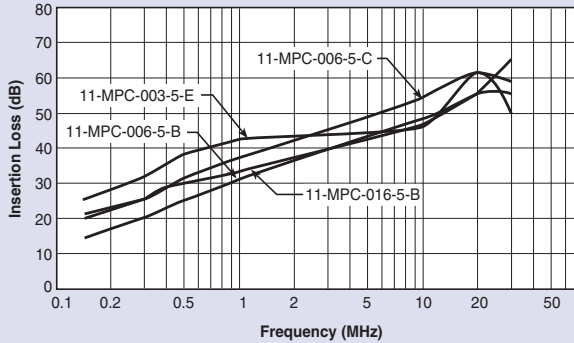

### Normal Mode

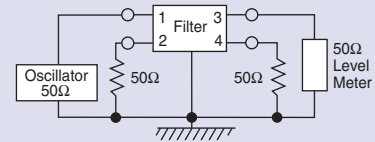

#### 11-MPC-001;-002

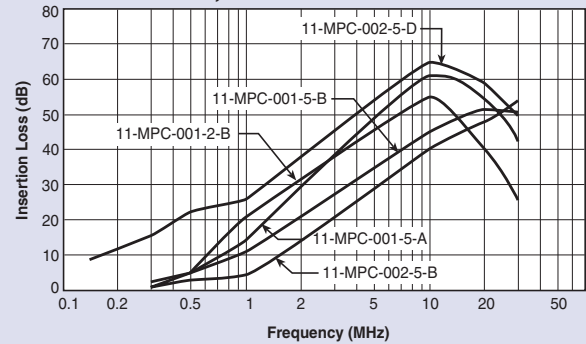

#### 11-MPC-003;-006;-016

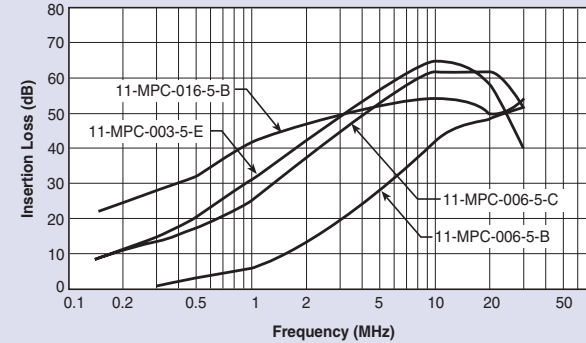

## MPC-010 & 015 Series

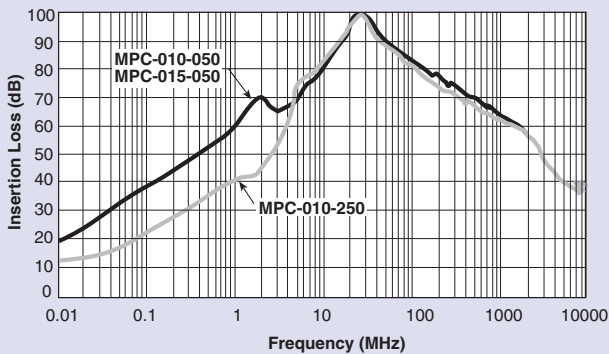

## Through-hole Filters High Frequency PCB Filters

API Technologies' Spectrum Control line of high frequency PCB filter provides EMI filtering to protect low power digital circuits, while meeting most government and industrial specifications for EMI control. With low assembly and installation costs, the PCB filter helps keep your project on budget. By mounting the PCB filter at the source of the problem, we eliminate the need for additional filtering at other points in the circuit. The filter mounts directly to a printed circuit board with no mounting bracket or plate needed, providing you with a lower total installed cost. In addition, the PCB filter can be flow-soldered with other components.

API's PCB filter has built-in standoffs, which allow for cleaning or coating beneath the filter, and the filter is encapsulated for environmental protection.

### Features

- Provides EMI filtering to protect low power digital circuits - helps equipment meet FCC and VDE specifications
- Mounts directly to printed circuit board with no bracket or plate for lower applied costs - can be flow soldered with other components
- Encapsulated for environmental protection
- Mounts on PCB to begin filtering at the source of the problem
- Built-in standoffs permit cleaning or coating under the filter

### Circuit Schematic



### Typical Electrical Characteristics

Current . . . . . Max. 10A DC; 0.3A RF

Operating Voltage . . . . . Max. 50 VDC, -25°C to +85°C

Capacitance . . . . . 800 pF min.

Dissipation Factor . . . . . 0.1 Max.

Dielectric

Withstanding Voltage . . . . . 125 VDC for 5 seconds

Insulation Resistance . . . . . Min. 100 MegOhms at 100 VDC for 2 minutes and 25°C

Direct Current

Resistance . . . . . 0.002 ohms Max.

Minimum No-Load

Insertion Loss . . . . . Per MIL-STD-220 at 25°C; PCB mounted, 50 ohm strip line

- 3dB @ 8 MHz
- 10dB @ 25 MHz
- 15dB @ 50 MHz
- 20dB @ 100 MHz-1GHz

### Preformed to Recommended Mounting Configuration Part Number 842448-2

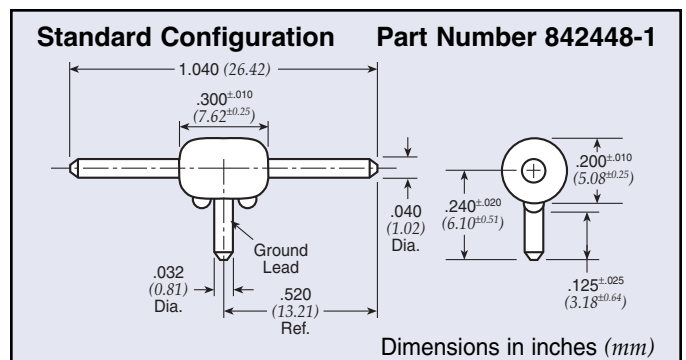
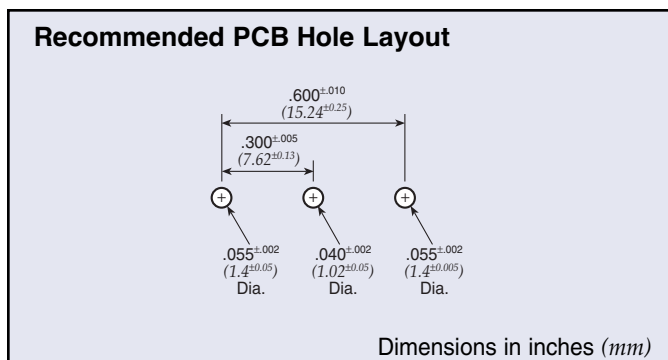
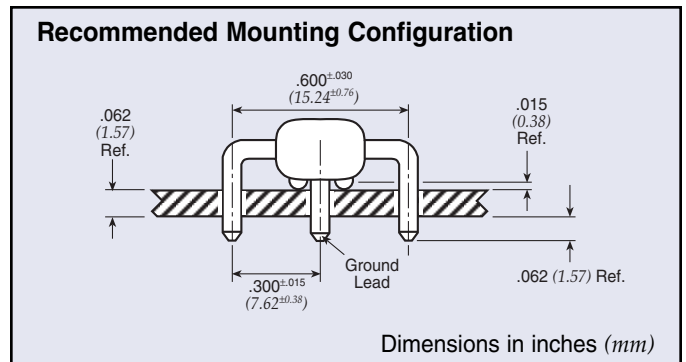



Компания «ЭлектроПласт» предлагает заключение долгосрочных отношений при поставках импортных электронных компонентов на взаимовыгодных условиях!

Наши преимущества:

- Оперативные поставки широкого спектра электронных компонентов отечественного и импортного производства напрямую от производителей и с крупнейших мировых складов;
- Поставка более 17-ти миллионов наименований электронных компонентов;
- Поставка сложных, дефицитных, либо снятых с производства позиций;
- Оперативные сроки поставки под заказ (от 5 рабочих дней);
- Экспресс доставка в любую точку России;
- Техническая поддержка проекта, помощь в подборе аналогов, поставка прототипов;
- Система менеджмента качества сертифицирована по Международному стандарту ISO 9001;
- Лицензия ФСБ на осуществление работ с использованием сведений, составляющих государственную тайну;
- Поставка специализированных компонентов (Xilinx, Altera, Analog Devices, Intersil, Interpoint, Microsemi, Aeroflex, Peregrine, Syfer, Eurofarad, Texas Instrument, Miteq, Cobham, E2V, MA-COM, Hittite, Mini-Circuits, General Dynamics и др.);

Помимо этого, одним из направлений компании «ЭлектроПласт» является направление «Источники питания». Мы предлагаем Вам помощь Конструкторского отдела:

- Подбор оптимального решения, техническое обоснование при выборе компонента;
- Подбор аналогов;
- Консультации по применению компонента;
- Поставка образцов и прототипов;
- Техническая поддержка проекта;
- Защита от снятия компонента с производства.



#### Как с нами связаться

**Телефон:** 8 (812) 309 58 32 (многоканальный)

**Факс:** 8 (812) 320-02-42

**Электронная почта:** [org@eplast1.ru](mailto:org@eplast1.ru)

**Адрес:** 198099, г. Санкт-Петербург, ул. Калинина, дом 2, корпус 4, литера А.