

## HA Varistor Series



### Agency Approvals

Agency	Agency Approval	Agency File Number
	UL1449	E320116
	22.2-1	91788

### Additional Information



Datasheet



Resources



Samples

### Description

HA Series transient surge suppressors are industrial high energy Metal-Oxide Varistors (MOVs). They are designed to provide secondary surge protection in the outdoor and service entrance environment (distribution panels) of buildings, and also in industrial applications for motor controls and power supplies used in the oil-drilling, mining, and transportation fields.

The design of the HA Series of MOVs provide rigid terminals for screw mounting. Also available in a clipped lead version for through hole board placement or to accommodate soldered leads designation "HC."

See Ratings and Specifications Table for part number and brand information.

### Features

- Lead-free, Halogen-Free and RoHS compliant.
- Wide operating voltage range  
 $V_{M(AC)RMS}$   
110V to 750V
- Two disc sizes available  
32mm and 40mm
- High energy absorption capability  
 $W_{TM} = 170J$  to 1050J
- High peak pulse current capability,  $ITM = 25,000A$  to 40,000A
- Rigid terminals for secure mounting
- Available in trimmed version for through hole board mounting – Designation "HC"
- No derating up to 85°C ambient

### Absolute Maximum Ratings

• For ratings of individual members of a series, see Device Ratings and Specifications chart

Continuous	HA Series	Units
Steady State Applied Voltage:		
AC Voltage Range ( $V_{M(AC)RMS}$ )	110 to 750	V
DC Voltage Range ( $V_{M(DC)}$ )	148 to 970	V
Transients:		
Peak Pulse Current ( $I_{TM}$ ) For 8/20 $\mu$ s Current Wave (See Figure 2)	25,000 to 40,000	A
Single Pulse Energy Range For 2ms Current Squarewave ( $W_{TM}$ )	160 to 1050	J
Operating Ambient Temperature Range ( $T_A$ )	-55 to +85	°C
Storage Temperature Range ( $T_{STG}$ )	-55 to +125	°C
Temperature Coefficient ( $\alpha^v$ ) of Clamping Voltage ( $V_C$ ) at Specified Test Current	<0.01	%/°C
Hi-Pot Encapsulation (COATING Isolation Voltage Capability) (Dielectric must withstand indicated DC voltage for one minute per MIL-STD 202, Method 301)	2500	V
COATING Insulation Resistance	1000	M $\Omega$

*CAUTION: Stresses above those listed in "Absolute Maximum Ratings" may cause permanent damage to the device. This is a stress only rating and operation of the device at these or any other conditions above those indicated in the operational sections of this specification is not implied.*

### HA Series Ratings & Specifications

Part Number Device Branding	Maximum Rating (85°C)				Specifications (25°C)				
	Continuous		Transient		Varistor Voltage at 1mA DC Test Current			Maximum Clamping Volt $V_C$ at 200A Current (8/20 $\mu$ s)	Typical Capacitance $f = 1$ MHz
	$V_{RMS}$	$V_{DC}$	Energy (2ms)	Peak Current 8 x 20 $\mu$ s					
	$V_{M(AC)}$	$V_{M(DC)}$	$W_{TM}$	$I_{TM}$	Min	$V_{N(DC)}$	Max	$V_C$	C
(V)	(V)	Energy	(A)	(V)	(V)	(V)	(A)	(pF)	
V111HA32 V111HA40	110 110	148 148	160 220	25000 40000 <sup>1</sup>	156 156	173 173	190 190	293 288	5450 11600
V131HA32 V131HA40	130 130	175 175	200 270	25000 40000 <sup>2</sup>	184.5 184.5	205 205	225.5 225.5	350 345	4700 10000
V141HA32 V141HA40	140 140	188 188	210 290	25000 40000 <sup>3</sup>	198 198	220 220	242 242	380 375	4230 9000
V151HA32 V151HA40	150 150	200 200	220 300	25000 40000 <sup>4</sup>	216 216	240 240	264 264	410 405	4000 8000
V181HA32 V181HA40	180 180	240 240	240 330	25000 40000	254 254	282 282	310 310	475 468	3200 6800
V201HA32 V201HA40	200 200	265 265	260 350	25000 40000	283 283	314 314	345 345	540 533	3180 6350
V251HA32 V251HA40	250 250	330 330	330 370	25000 40000	351 351	390 390	429 429	650 630	2500 5000
V271HA32 V271HA40	275 275	369 369	360 400	25000 40000	387 387	430 430	473 473	710 690	2200 4500
V301HA32 V301HA40	300 300	410 410	370 430	25000 40000	423 423	470 470	517 517	795 780	2050 4100
V321HA32 V321HA40	320 320	420 420	390 460	25000 40000	459 459	510 510	561 561	845 825	1900 3800
V331HA32 V331HA40	330 330	435 435	385 475	25000 40000	467 467	518.5 518.5	570 570	860 843	1870 3750
V351HA32 V351HA40	350 350	460 460	390 500	25000 40000	495 495	549.5 549.5	604 604	910 894	1800 3600
V391HA32 V391HA40	385 385	510 510	395 550	25000 40000	545 545	604 604	663 663	1020 1000	1750 3500
V421HA32 V421HA40	420 420	560 560	400 600	25000 40000	612 612	680 680	748 748	1120 1100	1500 3000
V441HA32 V441HA40	440 440	585 585	420 630	25000 40000	622 622	690 690	758 758	1200 1147	1450 2900
V481HA32 V481HA40	480 480	640 640	450 650	25000 40000	675 675	750 750	825 825	1290 1230	1300 2700
V511HA32 V511HA40	510 510	675 675	500 700	25000 40000	738 738	820 820	902 902	1355 1295	1200 2500
V551HA32 V551HA40	550 550	710 710	530 755	25000 40000	778 778	863.5 863.5	949 949	1515 1430	1190 2390
V571HA32 V571HA40	575 575	730 730	550 770	25000 40000	819 819	910 910	1001 1001	1570 1480	1100 2200
V661HA32 V661HA40	660 660	850 850	600 900	25000 40000	945 945	1050 1050	1155 1155	1820 1720	1000 2000
V681HA32 V681HA40	680 680	875 875	610 925	25000 40000	962 962	1067.5 1067.5	1173 1173	1830 1780	850 1900
V751HA32 V751HA40	750 750	970 970	700 1050	25000 40000	1080 1080	1200 1200	1320 1320	2050 2000	800 1800

NOTE: Average power dissipation of transients not to exceed 2.0W per varistor

1. 40kA capability depends on applications rated up to 97Vrms. 30kA applies if > 97 Vrms.
2. 40kA capability depends on applications rated up to 115Vrms. 30kA applies if > 115 Vrms.
3. 40kA capability depends on applications rated up to 123Vrms. 30kA applies if > 123 Vrms.
4. 40kA capability depends on applications rated up to 132Vrms. 30kA applies if > 132Vrms.

**Power Dissipation Ratings**

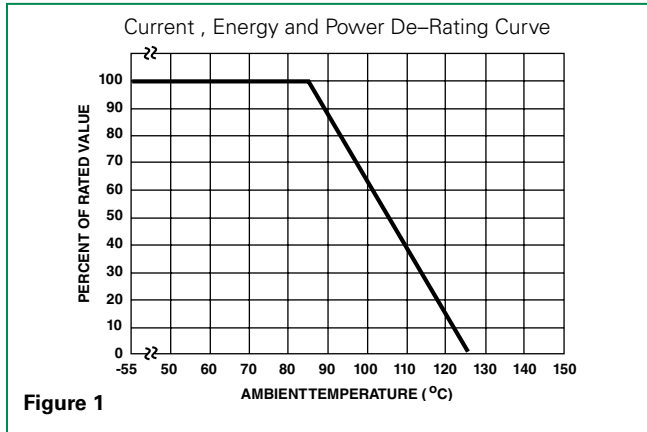

**Figure 1**

Should transients occur in rapid succession, the average power dissipation required is simply the energy (watt-seconds) per pulse times the number of pulses per second. The power so developed must be within the specifications shown on the Device Ratings and Specifications table for the specific device. Furthermore, the operating values need to be derated at high temperatures as shown in above. Because varistors can only dissipate a relatively small amount of average power they are, therefore, not suitable for repetitive applications that involve substantial amounts for average power dissipation.

**Peak Pulse Current Test Waveform**

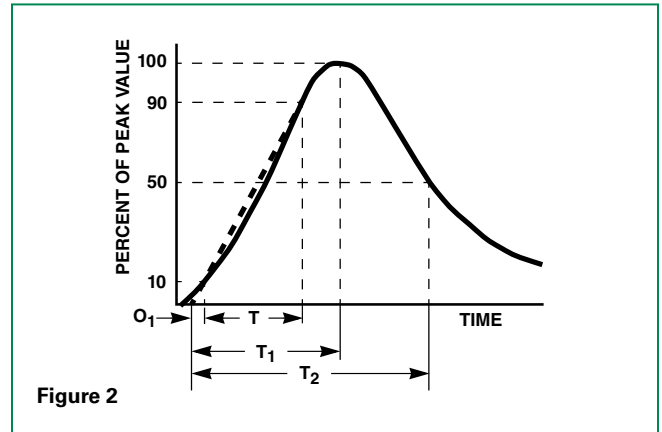

**Figure 2**

$O_1$  = Virtual Origin of Wave  
 $T$  = Time from 10% to 90% of Peak  
 $T_1$  = Rise Time =  $1.25 \times T$   
 $T_2$  = Decay Time

**Example** - For an  $8/20 \mu s$  Current Waveform:

$8 \mu s = T_1 = \text{Rise Time}$   
 $20 \mu s = T_2 = \text{Decay Time}$

**Maximum Clamping Voltage for 32mm Parts**

V111HA32-V751HA32

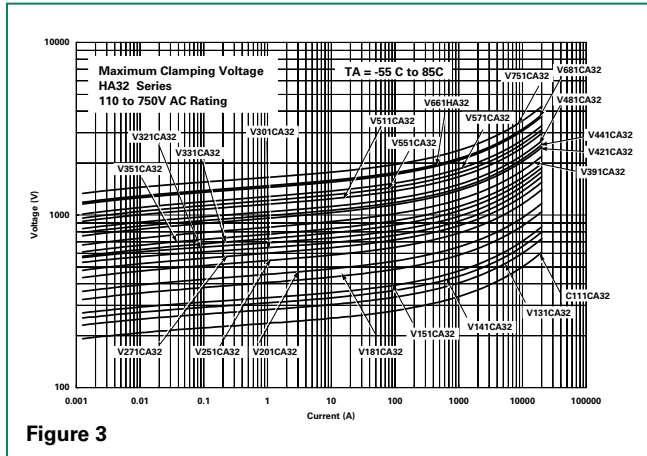

**Figure 3**

**Maximum Clamping Voltage for 40mm Parts**

V111HA40-V751HA40

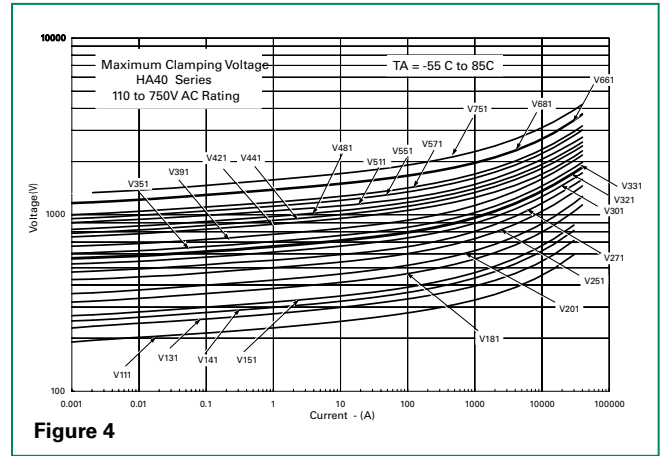

**Figure 4**

**Repetitive Surge Capability for 32mm Parts**

V111HA32 – V751HA32

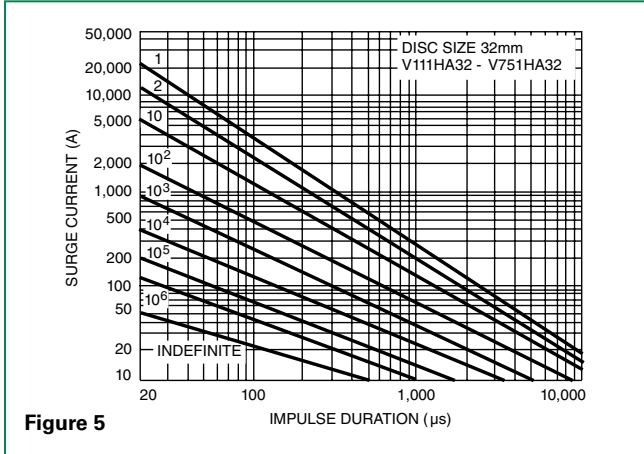

Figure 5

**Repetitive Surge Capability for 40mm Parts**

V111HA40 – V751HA40

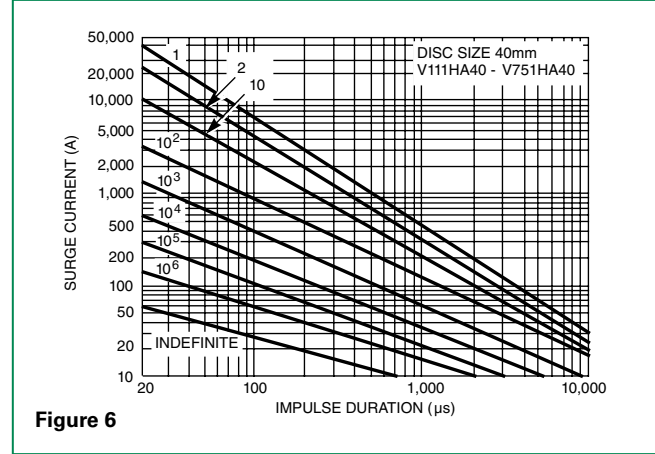

Figure 6

**Wave Solder Profile**

**Non Lead-free Profile**

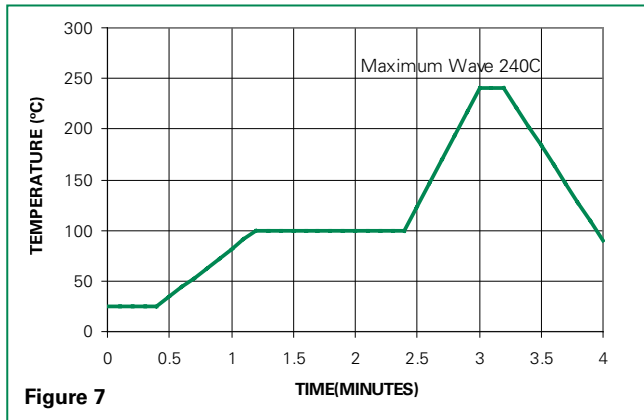

Figure 7

**Lead-free Profile**

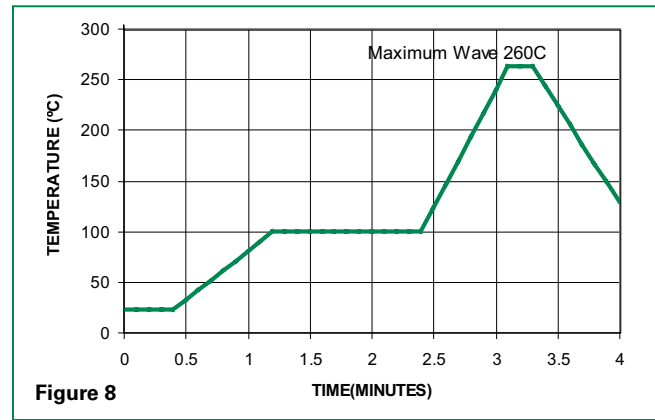

Figure 8

**Physical Specifications**

<b>Lead Material</b>	Tin-plated Copper
<b>Soldering Characteristics</b>	Solderability per MIL-STD-202, Method 208
<b>Insulating Material</b>	Cured, flame retardant epoxy polymer meets UL94V-0 requirements.
<b>Device Labeling</b>	LF, Part Number and date code

**Environmental Specifications**

<b>Operating Temperature</b>	-55°C to +85°C/
<b>Storage Temperature</b>	-55°C to +125°C
<b>Humidity Aging</b>	+85°C, 85% RH, 1000 hours +/- 10% typical resistance change
<b>Thermal Shock</b>	+85°C to -40°C 5 times +/- 10% typical resistance change
<b>Solvent Resistance</b>	MIL-STD-202, Method 215
<b>Moisture Sensitivity</b>	Level 1, J-STD-020

**Dimensions**

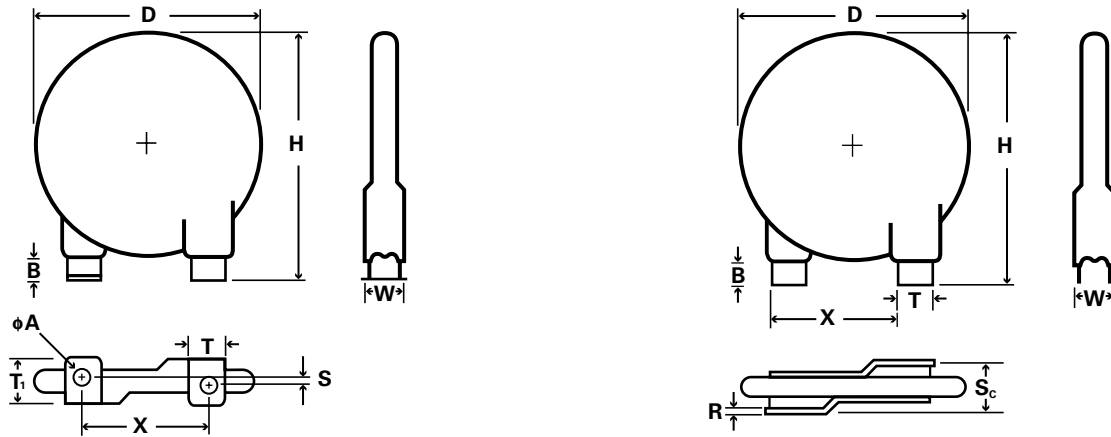

**HA Series Outline Specifications**

(Dimensions in Millimeters)

	D	H	B	X	T	T1	φA	s
	Max	Max	Min	Nom	Nom	Max	Max	Offset
HA32	35.5	50.00	3.0	25	9.3	10.4	4.2	Depends on Device Voltage (See Table Below)
HA40	42.5	57.00	3.0	25	9.3	10.4	4.2	

**HC Series Outline Specifications**

(Dimensions in Millimeters)

	D	H	B	X	T	R	s
	Max	Max	Min	Nom	Nom	Max	Offset
HC32	35.5	50.00	5.0	25	9.30	1.0	Depends on Device Voltage (See Table Below)
HC40	42.5	57.00	5.0	25	9.30	1.0	

**HA Series Maximum Thickness and Terminal Offsets**

(Dimensions in Millimeters)

Voltage	Thickness "W"		Dimension "S" (-/+1mm)	
	HA32	HA40	HA32	HA40
V111 - V351	9.00	9.00	3.90	3.90
V391 - V511	11.00	11.00	2.60	2.60
V551 - V751	13.00	13.00	1.00	1.00

**HC Series Maximum Thickness and Terminal Offsets**

(Dimensions in Millimeters)

Voltage	Thickness "W"		Dimension "S <sub>c</sub> " (-/+1mm)	
	HC32	HC40	HC32	HC40
V111 - V351	9.00	9.00	6.00	6.00
V391 - V511	11.00	11.00	7.30	8.10
V551 - V751	13.00	13.00	8.90	10.00

**Part Numbering System**

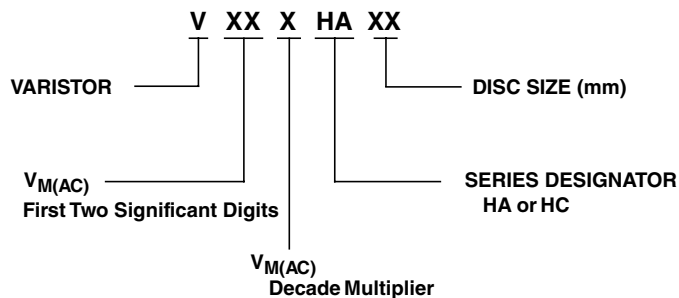



Компания «ЭлектроПласт» предлагает заключение долгосрочных отношений при поставках импортных электронных компонентов на взаимовыгодных условиях!

Наши преимущества:

- Оперативные поставки широкого спектра электронных компонентов отечественного и импортного производства напрямую от производителей и с крупнейших мировых складов;
- Поставка более 17-ти миллионов наименований электронных компонентов;
- Поставка сложных, дефицитных, либо снятых с производства позиций;
- Оперативные сроки поставки под заказ (от 5 рабочих дней);
- Экспресс доставка в любую точку России;
- Техническая поддержка проекта, помощь в подборе аналогов, поставка прототипов;
- Система менеджмента качества сертифицирована по Международному стандарту ISO 9001;
- Лицензия ФСБ на осуществление работ с использованием сведений, составляющих государственную тайну;
- Поставка специализированных компонентов (Xilinx, Altera, Analog Devices, Intersil, Interpoint, Microsemi, Aeroflex, Peregrine, Syfer, Eurofarad, Texas Instrument, Miteq, Cobham, E2V, MA-COM, Hittite, Mini-Circuits, General Dynamics и др.);

Помимо этого, одним из направлений компании «ЭлектроПласт» является направление «Источники питания». Мы предлагаем Вам помощь Конструкторского отдела:

- Подбор оптимального решения, техническое обоснование при выборе компонента;
- Подбор аналогов;
- Консультации по применению компонента;
- Поставка образцов и прототипов;
- Техническая поддержка проекта;
- Защита от снятия компонента с производства.



#### Как с нами связаться

**Телефон:** 8 (812) 309 58 32 (многоканальный)

**Факс:** 8 (812) 320-02-42

**Электронная почта:** [org@eplast1.ru](mailto:org@eplast1.ru)

**Адрес:** 198099, г. Санкт-Петербург, ул. Калинина, дом 2, корпус 4, литера А.