

EB20

11

B

J23

Poles & Circuits

11	SPDT	ON	(ON)
65	SPDT	ON	ON
61	DPDT	ON	(ON)
85	DPDT	ON	ON

() = Momentary

Contacts, Ratings, & Terminals

No Code	Silver Contacts; Solder Lug Terminals 3A @ 125V AC
G	Gold Contacts; Solder Lug Terminals 0.4VA max @ 28V AC/DC max
P	Silver Contacts; Straight PC Terminals; 3A @ 125V AC
PG	Gold Contacts; Straight PC Terminals 0.4VA max @ 28V AC/DC max

Cap Colors

A	Black
B	White
C	Red
E	Yellow
F	Green
G	Blue
H	Gray

Cap Extensions & Bezel Types

Low Rise		High Rise		Description
Momentary	Alternate	Momentary	Alternate	
J20	J30	J40	J50	Without Bezel
J21	J31	J41	J51	Bezel without LED
J22	J32	J42	J52	Bezel with 1 Round LED
J23	J33	J43	J53	Bezel with 2 Round LEDs
J24	J34	J44	J54	Bezel with 2 Rectangular LEDs

IMPORTANT:

Switches are supplied without UL, cULus & CSA marking unless specified.

UL, cULus & CSA recognized only when ordered with marking on the switch.

Specific models, ratings, & ordering instructions are noted on the General Specifications page.



DESCRIPTION FOR TYPICAL ORDERING EXAMPLE WITHOUT BEZEL

EB2011-A-J40

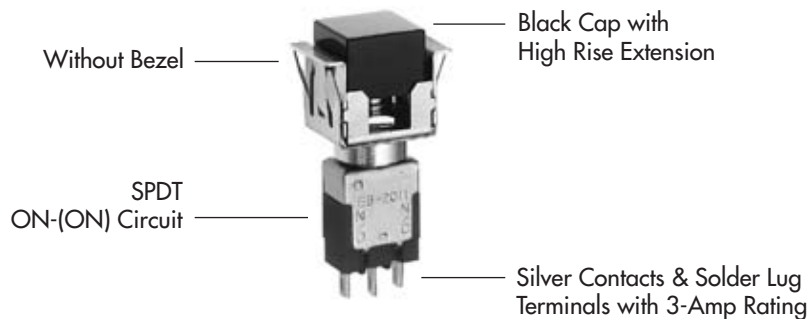

ORDERING EXAMPLES

A				C F			
Bezel Colors				Led Colors			
Bezel without LEDs							
A	Black	F	Green				
B	White	G	Blue				
C	Red	H	Gray				
E	Yellow						
Bezel with 1 Round LED				1 LED			
A	Black			C	Red		
				F	Green		
Bezel with 2 Round or Rectangular LEDs				2 LEDs			
				Top LED		Bottom LED	
A	Black			C	Red	C	Red
				E	Yellow	E	Yellow
				F	Green	F	Green

DESCRIPTION FOR TYPICAL ORDERING EXAMPLE WITH BEZEL

EB2011-B-J23ACF

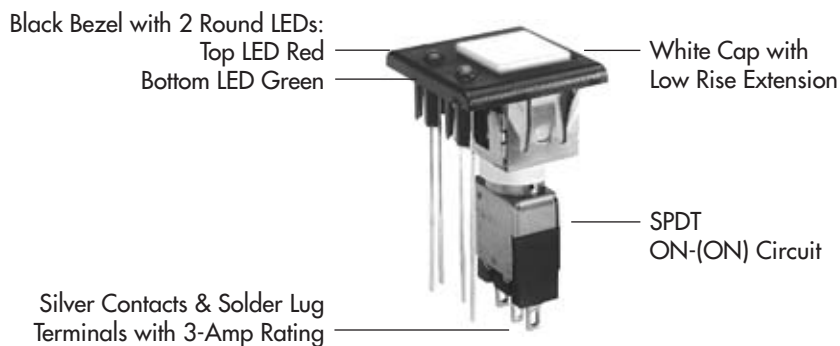

Toggles

Rockers

Pushbuttons

Illuminated PB

Programmable

Keylocks

Rotaries

Slides

Tactiles

Tilt

Touch

Indicators

Accessories

Supplement

POLES & CIRCUITS

		Plunger Position () = Momentary		Connected Terminals		Throw & Switch Schematics
Pole	Model	Normal 	Down 	Normal 	Down 	
SP	EB2011 EB2065	ON ON	(ON) ON	2-3	2-1	SPDT
DP	EB2061 EB2085	ON ON	(ON) ON	2-3 5-6	2-1 5-4	DPDT

Note: Terminal numbers are not actually on the switch.

CONTACT MATERIALS, RATINGS, & TERMINALS



Solder Lug
Silver Contacts

Power Level

3A @ 125V AC



Solder Lug
Gold Contacts

Logic Level

0.4VA maximum @ 28V AC/DC maximum

Complete explanation of operating range in Supplement section.

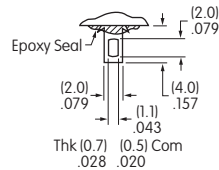

Straight PC
Silver Contacts

Power Level

3A @ 125V AC



Straight PC
Gold Contacts

Logic Level

0.4VA maximum @ 28V AC/DC maximum

Complete explanation of operating range in Supplement section.

PCB Footprints

Single Pole

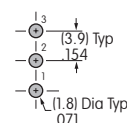

Double Pole

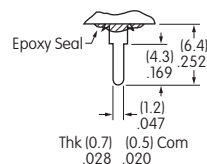
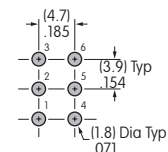

CAP COLORS

Factory Assembled on the Switch:
 Square snap-on cap AT465, snap-in moulder
 AT529, and optional bezels which follow.

- | | | | |
|----------------|----------------|---------------|-----------------|
| A Black | B White | C Red | E Yellow |
| F Green | G Blue | H Gray | |

CAP EXTENSIONS & BEZEL TYPES

Cap Extension without Bezel

J20

Low Rise Momentary

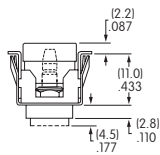

J30

Low Rise Alternate

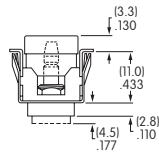

J40

High Rise Momentary

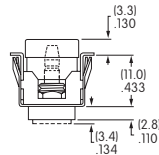

J50

High Rise Alternate

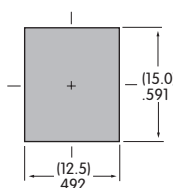
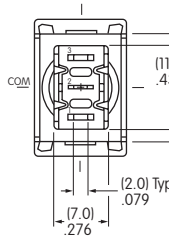
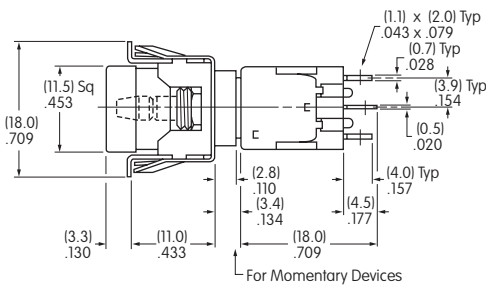
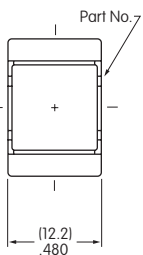
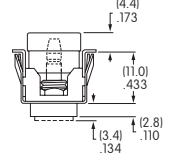

Maximum Panel Thickness
 .039" ~ .157" (1.0mm ~ 4.0mm)
 Cutout applies to SP & DP



High Rise

Single Pole

EB2011-A-J40

Cap Extension with Bezel

J21

Low Rise Momentary

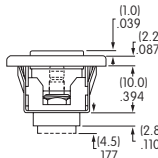

J31

Low Rise Alternate

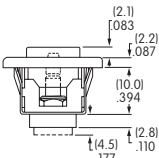

J41

High Rise Momentary

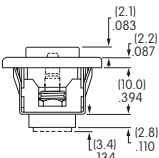

J51

High Rise Alternate

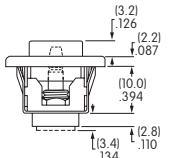

AT207 Bezel without LED

- | | | |
|-----------------|----------------|----------------------------|
| E Yellow | F Green | Material:
Polycarbonate |
| A Black | G Blue | |
| B White | H Gray | Finish:
Glossy |
| C Red | | |

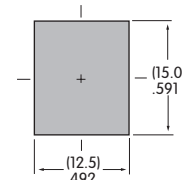
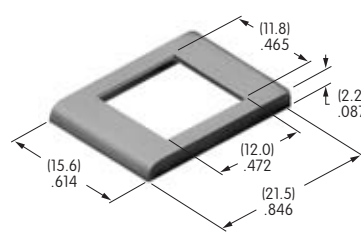

Maximum Panel Thickness
 .039" ~ .126" (1.0mm ~ 3.2mm)
 Cutout applies to SP & DP

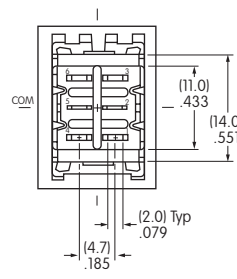
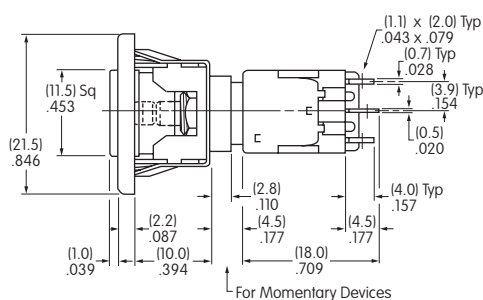
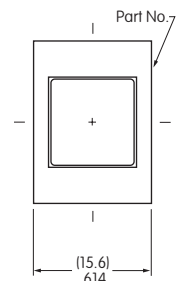

Low Rise

Double Pole

EB2061-B-J21A

CAP EXTENSIONS & BEZEL TYPES

Cap Extension with Bezel

J22

Low Rise Momentary

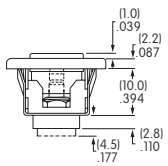

J32

Low Rise Alternate

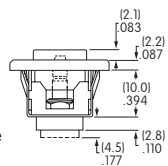

J42

High Rise Momentary

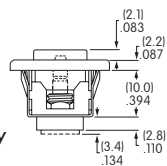

J52

High Rise Alternate

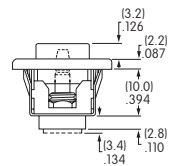

AT208 Bezel with 1 Round LED (AT070 LED)

A Black

Material: Polycarbonate
Finish: Glossy

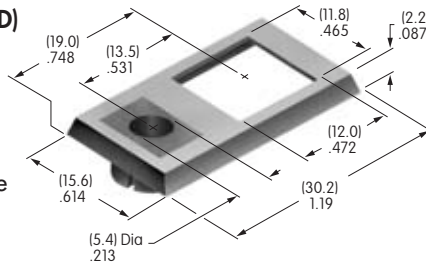

Maximum Panel Thickness
.039" ~ .126"
(1.0mm ~ 3.2mm)
Cutout applies to SP & DP

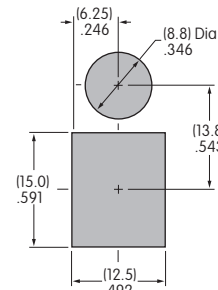

LED colors and specifications on next to last page of this EB section.

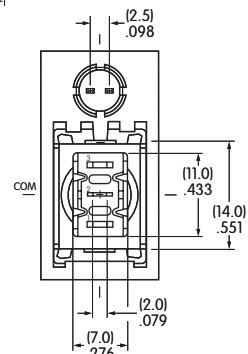
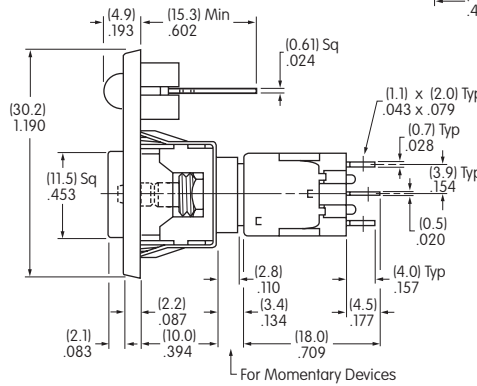
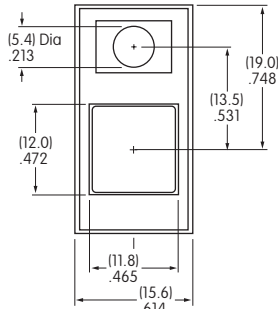

EB2011-B-J42AC

High Rise

Single Pole

Cap Extension with Bezel

J23

Low Rise Momentary

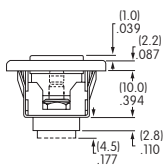

J33

Low Rise Alternate

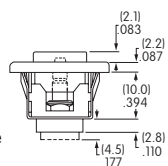

J43

High Rise Momentary

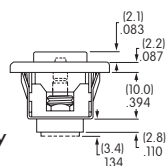

J53

High Rise Alternate

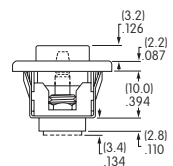

AT212 Bezel with 2 Round LEDs (AT617 LEDs)

A Black

Material: Polycarbonate
Finish: Glossy

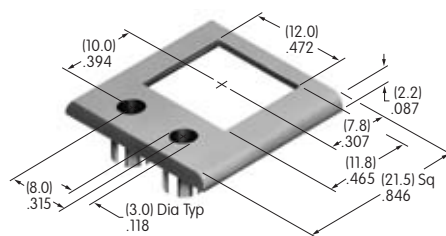

Maximum Panel Thickness
.039" ~ .126" (1.0mm ~ 3.2mm)
Cutout applies to SP & DP

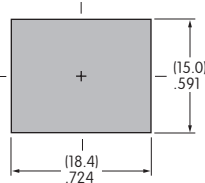

LED colors and specifications on next to last page of this EB section.

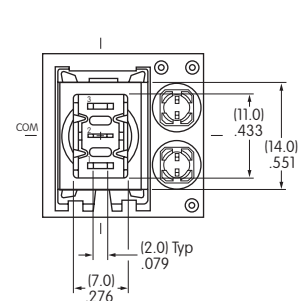
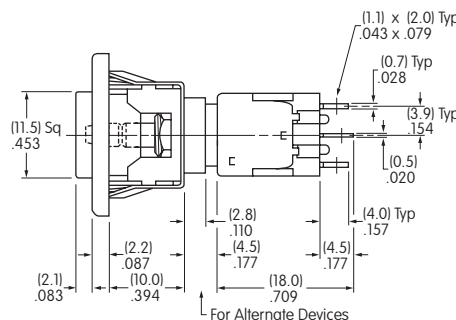
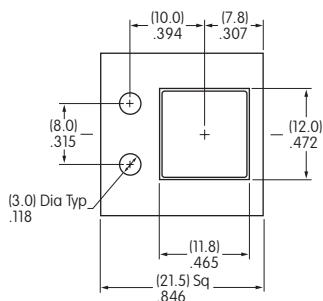

EB2065-B-J33ACF

Low Rise

Single Pole

CAP EXTENSIONS & BEZEL TYPES

Cap Extension with Bezel

J24

Low Rise Momentary

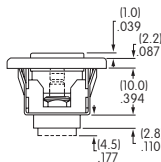

J34

Low Rise Alternate

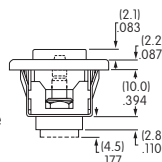

J44

High Rise Momentary

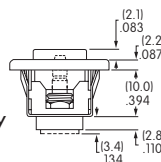

J54

High Rise Alternate

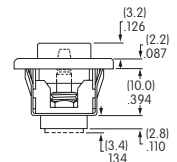

AT213 Bezel with 2 Rectangular LEDs (AT618 LEDs)

A

Black

Material: Polycarbonate
Finish: Glossy

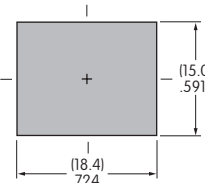
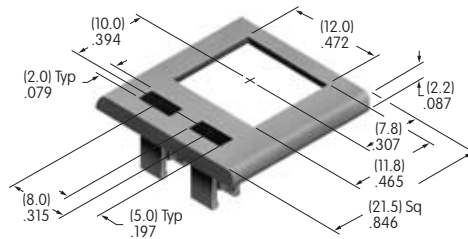

Maximum Panel Thickness
.039" ~ .126" (1.0mm ~ 3.2mm)
Cutout applies to SP & DP

LED colors and specifications on next page of this EB section.

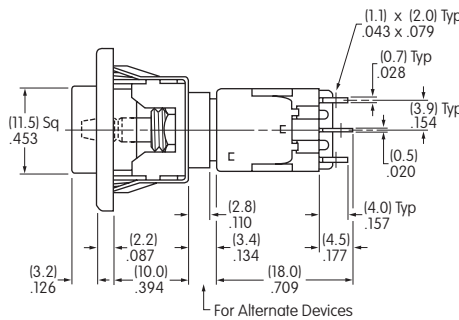
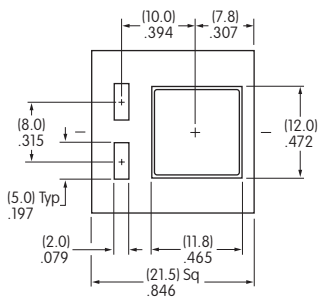

High Rise

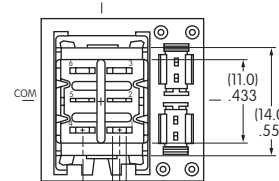

Double Pole



EB2085-B-J54ACF

LED COLORS & SPECIFICATIONS

Bezel Orientation on Switch

AT070 LED
For Bezel AT208
with 1 LED

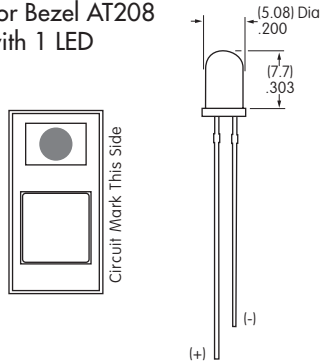

AT617 LED
For Bezel AT212
with 2 Round LEDs

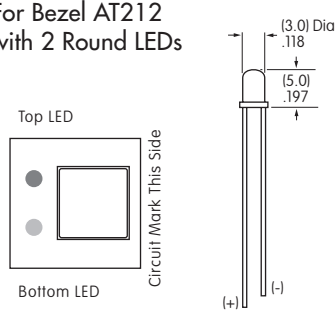

AT618 LED
For Bezel AT213
with 2 Rectangular LEDs

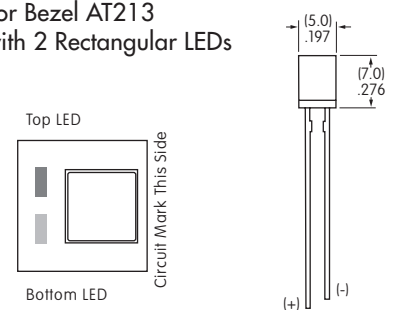

Note: Lead lengths may differ from manufacturing lot to lot. The longer lead is the anode (+).

		AT070		AT617			AT618		
		C	F	C	E	F	C	E	F
	Color	Red	Green	Red	Yellow	Green	Red	Yellow	Green
Maximum Forward Current	I_{FM}	25mA	30mA	30mA	30mA	25mA	25mA	30mA	25mA
Typical Forward Current	I_F	20mA	20mA	20mA	20mA	20mA	20mA	20mA	20mA
Forward Voltage	V_F	2.8V	2.1V	2.0V	2.1V	2.2V	2.25V	2.1V	2.2V
Maximum Reverse Voltage	V_{RM}	4V	5V	5V	5V	5V	5V	5V	5V
Current Reduction Rate Above 25°C	ΔI_F	0.33 mA/°C	0.40 mA/°C	0.40 mA/°C	0.40 mA/°C	0.33 mA/°C	0.33 mA/°C	0.40 mA/°C	0.33 mA/°C
Ambient Temperature Range (when used with a bezel)		-10° ~ +70°C		-15° ~ +70°C			-25° ~ +70°C		

The electrical specifications shown are determined at a basic temperature of 25°C.
LED circuit is independent of switch operation. LED is colored in OFF state.

If the source voltage is greater than the rated voltage of the LED, a ballast resistor must be connected in series with the lamp.
The ballast resistor calculation and more lamp detail are shown in the Supplement section.

LEGENDS

NKK Switches can provide custom legends for caps. Contact factory for more information.

Suggested Printable Area for Cap

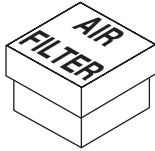
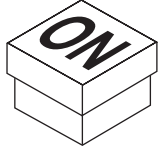

Recommended Print Method:

Screen Print or Pad Print

Epoxy based ink is recommended.

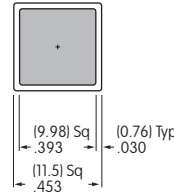

AT465

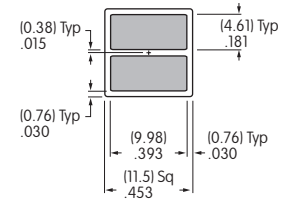

AT465

Shaded areas are printable areas.

Toggles

Rockers

C Pushbuttons

Illuminated PB

Programmable

Keylocks

Rotaries

Slides

Tactiles

Tilt

Touch

Indicators

Accessories

Supplement



Компания «ЭлектроПласт» предлагает заключение долгосрочных отношений при поставках импортных электронных компонентов на взаимовыгодных условиях!

Наши преимущества:

- Оперативные поставки широкого спектра электронных компонентов отечественного и импортного производства напрямую от производителей и с крупнейших мировых складов;
- Поставка более 17-ти миллионов наименований электронных компонентов;
- Поставка сложных, дефицитных, либо снятых с производства позиций;
- Оперативные сроки поставки под заказ (от 5 рабочих дней);
- Экспресс доставка в любую точку России;
- Техническая поддержка проекта, помощь в подборе аналогов, поставка прототипов;
- Система менеджмента качества сертифицирована по Международному стандарту ISO 9001;
- Лицензия ФСБ на осуществление работ с использованием сведений, составляющих государственную тайну;
- Поставка специализированных компонентов (Xilinx, Altera, Analog Devices, Intersil, Interpoint, Microsemi, Aeroflex, Peregrine, Syfer, Eurofarad, Texas Instrument, Miteq, Cobham, E2V, MA-COM, Hittite, Mini-Circuits, General Dynamics и др.);

Помимо этого, одним из направлений компании «ЭлектроПласт» является направление «Источники питания». Мы предлагаем Вам помощь Конструкторского отдела:

- Подбор оптимального решения, техническое обоснование при выборе компонента;
- Подбор аналогов;
- Консультации по применению компонента;
- Поставка образцов и прототипов;
- Техническая поддержка проекта;
- Защита от снятия компонента с производства.



Как с нами связаться

Телефон: 8 (812) 309 58 32 (многоканальный)

Факс: 8 (812) 320-02-42

Электронная почта: org@eplast1.ru

Адрес: 198099, г. Санкт-Петербург, ул. Калинина, дом 2, корпус 4, литера А.