

EB20

11

B

J23

#### Poles & Circuits

11	SPDT	ON	(ON)
65	SPDT	ON	ON
61	DPDT	ON	(ON)
85	DPDT	ON	ON

( ) = Momentary

#### Contacts, Ratings, & Terminals

<b>No Code</b>	Silver Contacts; Solder Lug Terminals 3A @ 125V AC
<b>G</b>	Gold Contacts; Solder Lug Terminals 0.4VA max @ 28V AC/DC max
<b>P</b>	Silver Contacts; Straight PC Terminals; 3A @ 125V AC
<b>PG</b>	Gold Contacts; Straight PC Terminals 0.4VA max @ 28V AC/DC max

#### Cap Colors

<b>A</b>	Black
<b>B</b>	White
<b>C</b>	Red
<b>E</b>	Yellow
<b>F</b>	Green
<b>G</b>	Blue
<b>H</b>	Gray

#### Cap Extensions & Bezel Types

Low Rise		High Rise		Description
Momentary	Alternate	Momentary	Alternate	
J20	J30	J40	J50	Without Bezel
J21	J31	J41	J51	Bezel without LED
J22	J32	J42	J52	Bezel with 1 Round LED
J23	J33	J43	J53	Bezel with 2 Round LEDs
J24	J34	J44	J54	Bezel with 2 Rectangular LEDs

#### IMPORTANT:

Switches are supplied without UL, cULus & CSA marking unless specified.

**UL, cULus & CSA recognized only when ordered with marking on the switch.**

Specific models, ratings, & ordering instructions are noted on the General Specifications page.



#### DESCRIPTION FOR TYPICAL ORDERING EXAMPLE WITHOUT BEZEL

**EB2011-A-J40**

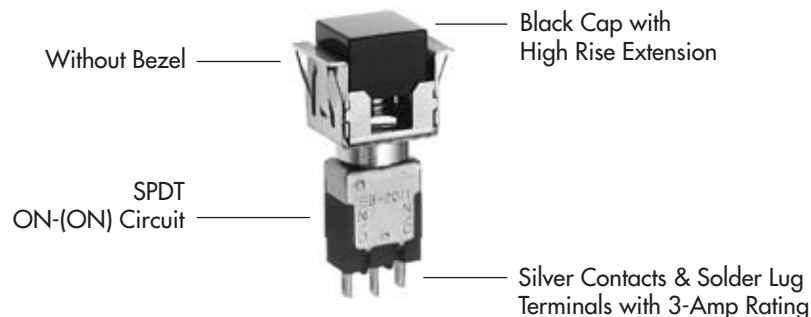

ORDERING EXAMPLES

<b>A</b>				<b>C F</b>			
<b>Bezel Colors</b>				<b>Led Colors</b>			
<b>Bezel without LEDs</b>							
<b>A</b>	Black	<b>F</b>	Green				
<b>B</b>	White	<b>G</b>	Blue				
<b>C</b>	Red	<b>H</b>	Gray				
<b>E</b>	Yellow						
<b>Bezel with 1 Round LED</b>				<b>1 LED</b>			
<b>A</b>	Black			<b>C</b>	Red		
				<b>F</b>	Green		
<b>Bezel with 2 Round or Rectangular LEDs</b>				<b>2 LEDs</b>			
				<b>Top LED</b>		<b>Bottom LED</b>	
<b>A</b>	Black			<b>C</b>	Red	<b>C</b>	Red
				<b>E</b>	Yellow	<b>E</b>	Yellow
				<b>F</b>	Green	<b>F</b>	Green

DESCRIPTION FOR TYPICAL ORDERING EXAMPLE WITH BEZEL

**EB2011-B-J23ACF**

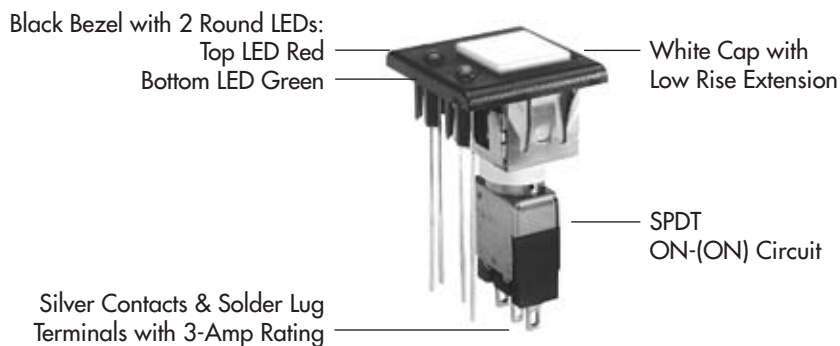

Toggles

Rockers

Pushbuttons

Illuminated PB

Programmable

Keylocks

Rotaries

Slides

Tactiles

Tilt







Touch

Indicators

Accessories

Supplement

## POLES & CIRCUITS

		Plunger Position ( ) = Momentary		Connected Terminals		Throw & Switch Schematics
Pole	Model	Normal 	Down 	Normal 	Down 	Note: Terminal numbers are not actually on the switch.
SP	EB2011 EB2065	ON ON	(ON) ON	2-3	2-1	SPDT 
DP	EB2061 EB2085	ON ON	(ON) ON	2-3 5-6	2-1 5-4	DPDT 

## CONTACT MATERIALS, RATINGS, & TERMINALS



Solder Lug  
Silver Contacts

Power Level

3A @ 125V AC



Solder Lug  
Gold Contacts

Logic Level

0.4VA maximum @ 28V AC/DC maximum

Complete explanation of operating range in Supplement section.

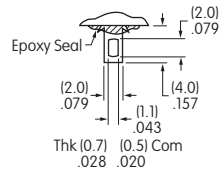

Straight PC  
Silver Contacts

Power Level

3A @ 125V AC



Straight PC  
Gold Contacts

Logic Level

0.4VA maximum @ 28V AC/DC maximum

Complete explanation of operating range in Supplement section.

### PCB Footprints

Single Pole

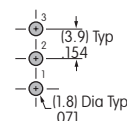

Double Pole

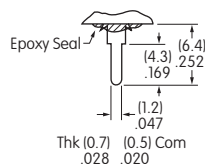
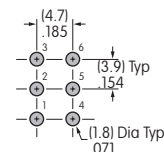

## CAP COLORS

Factory Assembled on the Switch:  
 Square snap-on cap AT465, snap-in moulder  
 AT529, and optional bezels which follow.

- |                |                |               |                 |
|----------------|----------------|---------------|-----------------|
| <b>A</b> Black | <b>B</b> White | <b>C</b> Red  | <b>E</b> Yellow |
| <b>F</b> Green | <b>G</b> Blue  | <b>H</b> Gray |                 |

## CAP EXTENSIONS & BEZEL TYPES

Cap Extension without Bezel

**J20**

Low Rise Momentary

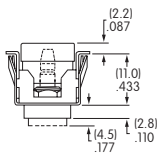

**J30**

Low Rise Alternate

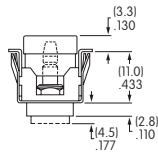

**J40**

High Rise Momentary

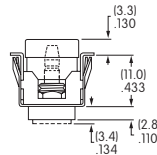

**J50**

High Rise Alternate

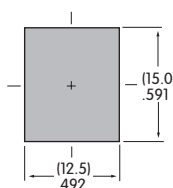
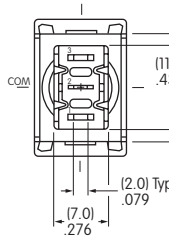
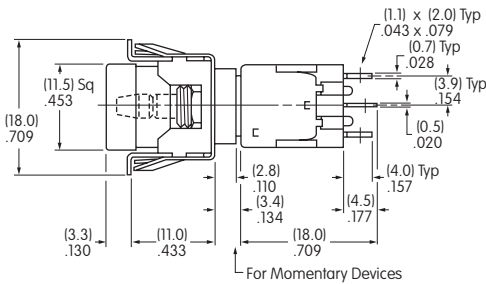
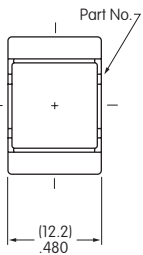
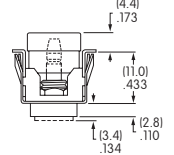

Maximum Panel Thickness  
 .039" ~ .157" (1.0mm ~ 4.0mm)  
 Cutout applies to SP & DP



High Rise

Single Pole

**EB2011-A-J40**

Cap Extension with Bezel

**J21**

Low Rise Momentary

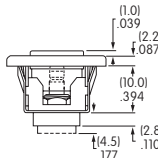

**J31**

Low Rise Alternate

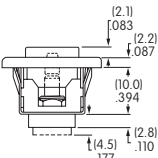

**J41**

High Rise Momentary

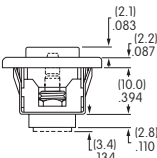

**J51**

High Rise Alternate

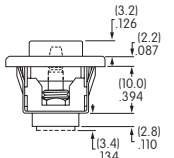

AT207 Bezel without LED

- |                 |                |                            |
|-----------------|----------------|----------------------------|
| <b>E</b> Yellow | <b>F</b> Green | Material:<br>Polycarbonate |
| <b>A</b> Black  | <b>G</b> Blue  |                            |
| <b>B</b> White  | <b>H</b> Gray  | Finish:<br>Glossy          |
| <b>C</b> Red    |                |                            |

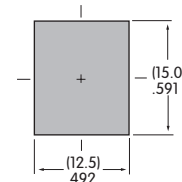
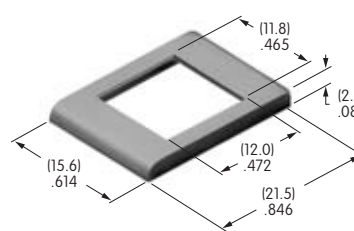

Maximum Panel Thickness  
 .039" ~ .126" (1.0mm ~ 3.2mm)  
 Cutout applies to SP & DP

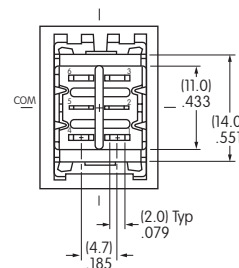
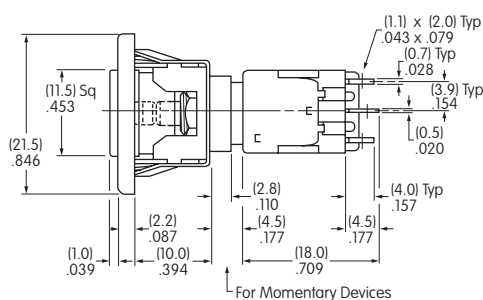
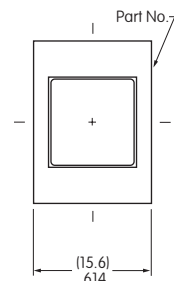

Low Rise

Double Pole

**EB2061-B-J21A**

## CAP EXTENSIONS & BEZEL TYPES

**Cap Extension with Bezel**

**J22**  
Low Rise  
Momentary

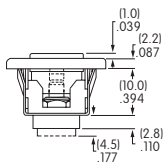

**J32**  
Low Rise  
Alternate

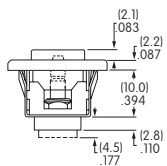

**J42**  
High Rise  
Momentary

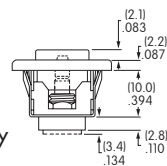

**J52**  
High Rise  
Alternate

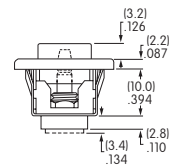

**AT208 Bezel with 1 Round LED (AT070 LED)**

**A** Black

Material: Polycarbonate  
Finish: Glossy

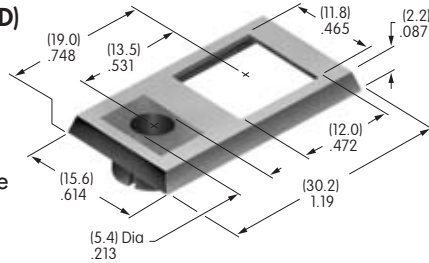

Maximum Panel Thickness  
.039" ~ .126"  
(1.0mm ~ 3.2mm)  
Cutout applies to SP & DP

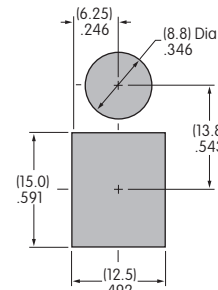

LED colors and specifications on next to last page of this EB section.

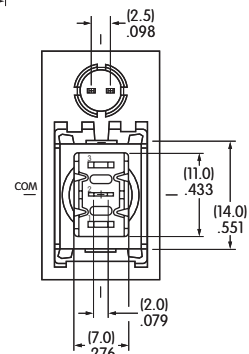
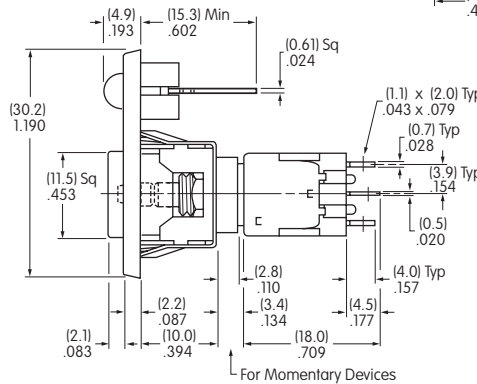
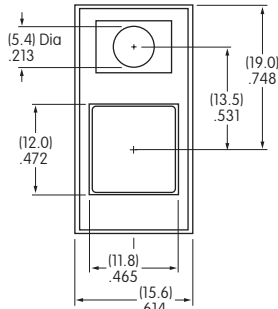

**EB2011-B-J42AC**

High Rise

Single Pole

**Cap Extension with Bezel**

**J23**  
Low Rise  
Momentary

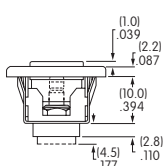

**J33**  
Low Rise  
Alternate

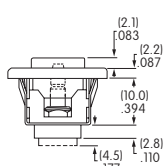

**J43**  
High Rise  
Momentary

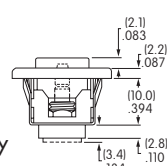

**J53**  
High Rise  
Alternate

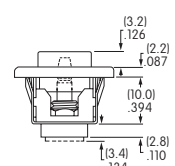

**AT212 Bezel with 2 Round LEDs (AT617 LEDs)**

**A** Black

Material: Polycarbonate  
Finish: Glossy

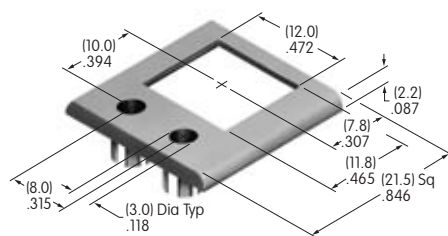

Maximum Panel Thickness  
.039" ~ .126" (1.0mm ~ 3.2mm)  
Cutout applies to SP & DP

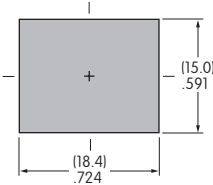

LED colors and specifications on next to last page of this EB section.

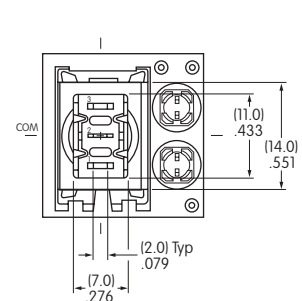
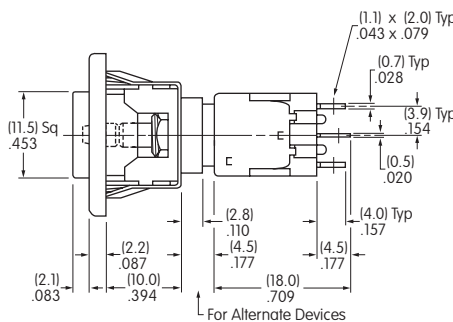
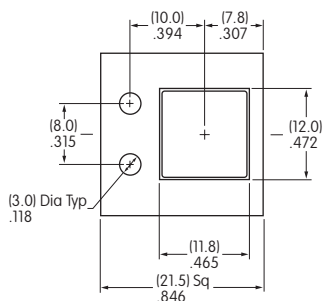

**EB2065-B-J33ACF**

Low Rise

Single Pole

## CAP EXTENSIONS & BEZEL TYPES

Cap Extension with Bezel

**J24**  
Low Rise Momentary

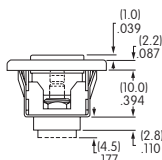

**J34**  
Low Rise Alternate

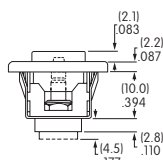

**J44**  
High Rise Momentary

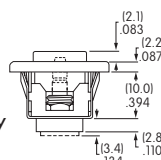

**J54**  
High Rise Alternate

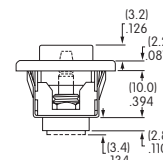

AT213 Bezel with 2 Rectangular LEDs (AT618 LEDs)

**A** Black

Material: Polycarbonate  
Finish: Glossy

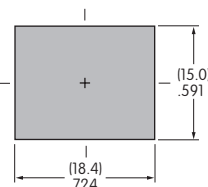
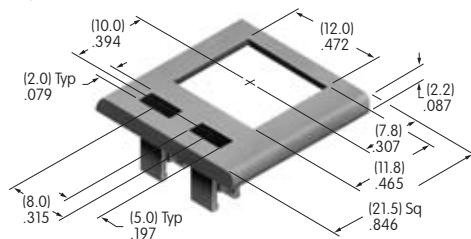

Maximum Panel Thickness  
.039" ~ .126" (1.0mm ~ 3.2mm)  
Cutout applies to SP & DP

LED colors and specifications on next page of this EB section.

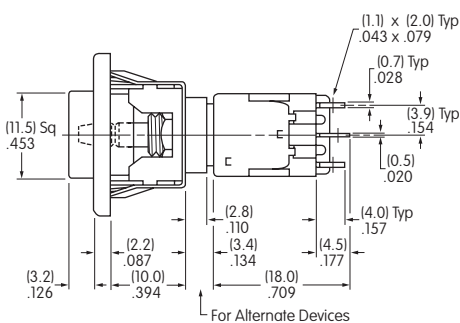
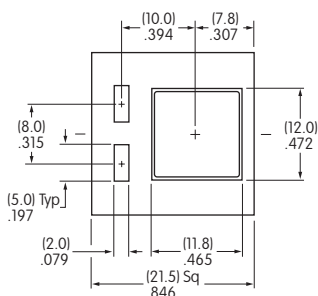

High Rise

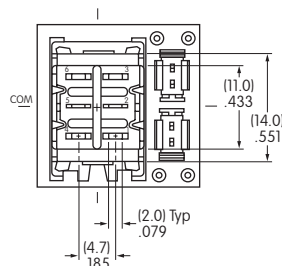

Double Pole



EB2085-B-J54ACF

Toggle  
Rockers  
Pushbuttons  
Illuminated PB  
Programmable  
Keylocks  
Rotaries  
Slides  
Tactiles  
Tilt  
Touch  
Indicators  
Accessories  
Supplement

### LED COLORS & SPECIFICATIONS

#### Bezel Orientation on Switch

**AT070 LED**  
For Bezel AT208  
with 1 LED

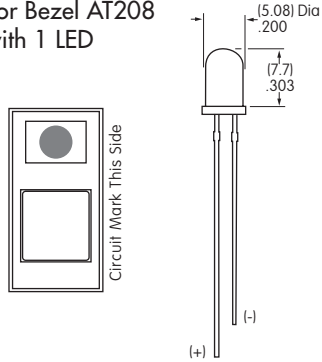

**AT617 LED**  
For Bezel AT212  
with 2 Round LEDs

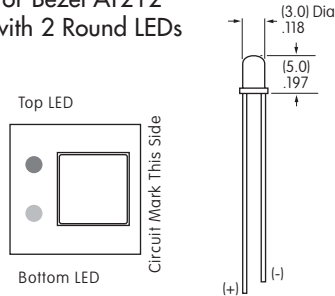

**AT618 LED**  
For Bezel AT213  
with 2 Rectangular LEDs

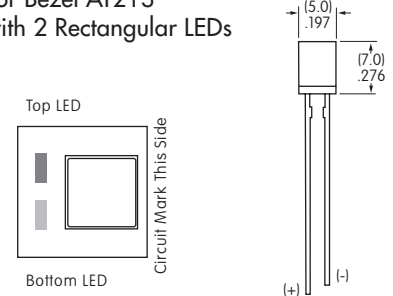

Note: Lead lengths may differ from manufacturing lot to lot. The longer lead is the anode (+).

		AT070		AT617			AT618		
		C	F	C	E	F	C	E	F
	Color	Red	Green	Red	Yellow	Green	Red	Yellow	Green
Maximum Forward Current	$I_{FM}$	25mA	30mA	30mA	30mA	25mA	25mA	30mA	25mA
Typical Forward Current	$I_F$	20mA	20mA	20mA	20mA	20mA	20mA	20mA	20mA
Forward Voltage	$V_F$	2.8V	2.1V	2.0V	2.1V	2.2V	2.25V	2.1V	2.2V
Maximum Reverse Voltage	$V_{RM}$	4V	5V	5V	5V	5V	5V	5V	5V
Current Reduction Rate Above 25°C	$\Delta I_F$	0.33 mA/°C	0.40 mA/°C	0.40 mA/°C	0.40 mA/°C	0.33 mA/°C	0.33 mA/°C	0.40 mA/°C	0.33 mA/°C
Ambient Temperature Range (when used with a bezel)		-10° ~ +70°C		-15° ~ +70°C			-25° ~ +70°C		

The electrical specifications shown are determined at a basic temperature of 25°C.  
LED circuit is independent of switch operation. LED is colored in OFF state.

If the source voltage is greater than the rated voltage of the LED, a ballast resistor must be connected in series with the lamp.  
The ballast resistor calculation and more lamp detail are shown in the Supplement section.

## LEGENDS

NKK Switches can provide custom legends for caps. Contact factory for more information.

### Suggested Printable Area for Cap



#### Recommended Print Method:

Screen Print or Pad Print

Epoxy based ink is recommended.

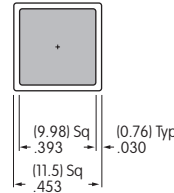

AT465

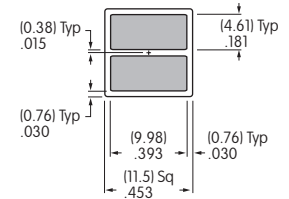

AT465

Shaded areas are printable areas.

Toggles

Rockers

**C** Pushbuttons

Illuminated PB

Programmable

Keylocks

Rotaries

Slides

Tactiles

Tilt

Touch

Indicators

Accessories

Supplement





Компания «ЭлектроПласт» предлагает заключение долгосрочных отношений при поставках импортных электронных компонентов на взаимовыгодных условиях!

Наши преимущества:

- Оперативные поставки широкого спектра электронных компонентов отечественного и импортного производства напрямую от производителей и с крупнейших мировых складов;
- Поставка более 17-ти миллионов наименований электронных компонентов;
- Поставка сложных, дефицитных, либо снятых с производства позиций;
- Оперативные сроки поставки под заказ (от 5 рабочих дней);
- Экспресс доставка в любую точку России;
- Техническая поддержка проекта, помощь в подборе аналогов, поставка прототипов;
- Система менеджмента качества сертифицирована по Международному стандарту ISO 9001;
- Лицензия ФСБ на осуществление работ с использованием сведений, составляющих государственную тайну;
- Поставка специализированных компонентов (Xilinx, Altera, Analog Devices, Intersil, Interpoint, Microsemi, Aeroflex, Peregrine, Syfer, Eurofarad, Texas Instrument, Miteq, Cobham, E2V, MA-COM, Hittite, Mini-Circuits, General Dynamics и др.);

Помимо этого, одним из направлений компании «ЭлектроПласт» является направление «Источники питания». Мы предлагаем Вам помощь Конструкторского отдела:

- Подбор оптимального решения, техническое обоснование при выборе компонента;
- Подбор аналогов;
- Консультации по применению компонента;
- Поставка образцов и прототипов;
- Техническая поддержка проекта;
- Защита от снятия компонента с производства.



#### Как с нами связаться

**Телефон:** 8 (812) 309 58 32 (многоканальный)

**Факс:** 8 (812) 320-02-42

**Электронная почта:** [org@eplast1.ru](mailto:org@eplast1.ru)

**Адрес:** 198099, г. Санкт-Петербург, ул. Калинина, дом 2, корпус 4, литера А.