

The PowerMod® connector family offers minimum size and high power. The high performance contacts and insulator are rated for 30 amps continuous. Applications requiring lower operating temperatures can be de-rated using our current-temperature chart.

The one row female PowerMod connectors are offered in 3, 4, 6 and 8 circuit sizes. The connectors are available with straight crimp, straight PCB or right angle PCB contacts.

APP connectors are manufactured using the finest materials and world-class manufacturing processes. They embody the highest quality in the industry and meet all applicable industry standards.

### FEATURES

- **High performance contacts**  
*Rated to 30 amps per IEC 512-3*
- **Mechanically polarized housings**  
*Only mate one-way, ensuring proper mating*
- **High reliability positive retention latches**  
*Are made from stainless steel to provide optimum performance*
- **PCB, panel or cable mounting**  
*A wide variety of contact styles with optional mounting brackets, panel clips and back-shell hoods provide broad design flexibility*



### SPECIFICATIONS

Electrical		Mechanical	
Current Rating		Mating Cycles No Load per IEC 512-5	1,000
IEC 512-3, UL 1977 (Amperes)	30	Mating / Unmating Force per IEC 512-13	10 oz (3N) avg.
UL / CSA Voltage Rating (AC/DC)	600	Contact Retention per IEC 512-8	18 lb (80N) Crimp 9 lb (40N) PCB Connector
Creepage / Clearance Distance	3.2 mm (.125") Min		
Contact Resistance per IEC 512-2	3 milliohms	Materials	
Dielectric Withstanding Voltage (AC)	2,200	Insulator	PPS UL94 V-0, material group IIIa
Contact Wire Range (AWG)	#24 to #12	Socket Body	Copper alloy, 200 μ inch Sn Bright over Ni
(mm²) *	0.25 to 4.0	Socket Contact	BeCu, 30 μ inch Au over Ni
Operating Temperature (°C)	-55° to 180°	Retention Clips	Stainless steel
(°F)	-67° to 356°	Hoods	PBT UL94 V-0



\* Stranding, IEC class 5 or lower

### ORDERING INFORMATION

#### PowerMod Part Number Plan - One Row Female

Series	Rows	# Poles	Gender	Contact	Latch	Mounting	Customized Connector			
PM	1	03	F	BA	L	CH	-	X	X	X
1							Consult factory for options			
03, 04, 06, 08 Poles							OO - None SB - R/A PCB Snap Bracket HB - R/A PCB Bracket with Hole ST - Self-tapping screws for straight PCB mount SP - Push in fastener for straight PCB mount CH - With clam-shell hood PC - Panel Clip MC - Mounting Clip SC - Screw for 1.6mm panel mount			
F - Female							L - Connector with latch (standard for contact type OO) O - No latch			
OO - None (Crimp contacts ordered separately) BA - Straight PCB Solder Standard Length-RoHS RA - R/A PCB Solder Standard Length-RoHS										

#### Tooling

Part Number	Mil-Standard	Description
TM0001	M22520/1-01	AF8 hand tool
TP0001	N/A	WA27F pneumatic crimp tool
Turret & Locator for TM0001 & TP0001		
TL0001	N/A	For pin contacts
TL0002	N/A	For socket contacts
TL0004	M22520/1-03	For pin & socket contacts
PM1000G1	N/A	Pneumatic four indent hand tool with locator
PM1001G1	N/A	Semi automatic loose piece crimp machine
PM1002G1	N/A	Contact insertion tool
PM1003G1	N/A	Contact extraction tool

HEADQUARTERS: Anderson Power Products®, 13 Pratts Junction Road, Sterling, MA 01564-2305 USA T:978-422-3600 F:978-422-3700

EUROPE: Anderson Power Products® Ltd., Unit 3, Europa Court, Europa Boulevard, Westbrook, Warrington, Cheshire, WA5 7TN United Kingdom T: +44 (0) 1925 428390 F: +44 (0) 1925 428399

ASIA/ PACIFIC: IDEAL AndersonAsia Pacific Ltd., Unit 922-928 Topsail Plaza, 11 On Sum Street, Shatin N.T., Hong Kong T: +(852) 2636 0836 F: +(852) 2635 9036

CHINA: IDEAL Anderson Technologies (Shenzhen) Ltd., Block A8 Tantou Western Industrial Park, Songgang Baoan District, Shenzhen, PR. China 518105 T: +(86) 755 2768 2118 F: +(86) 755 2768 2218

TAIWAN: IDEAL Anderson Asia Pacific Ltd., Taiwan Branch, 4F.-2, No.116, Dadun 20th St., Situn District, Taichung City 407, Taiwan (R.O.C.) T: +(886) 4 2310 6451 F: +(886) 4 2310 6460

[www.andersonpower.com](http://www.andersonpower.com)

# One Row Cable Connector (female)

## TEMPERATURE CHARTS

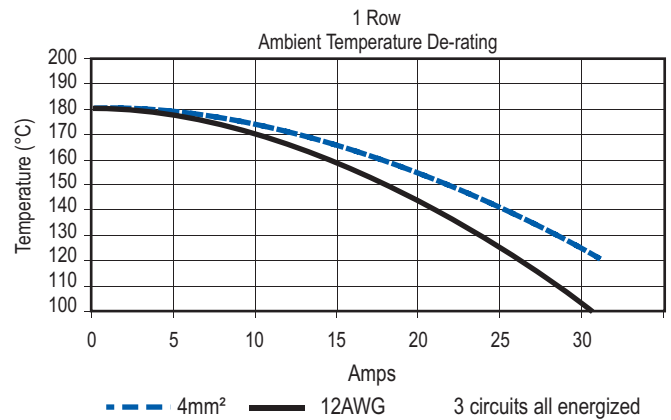
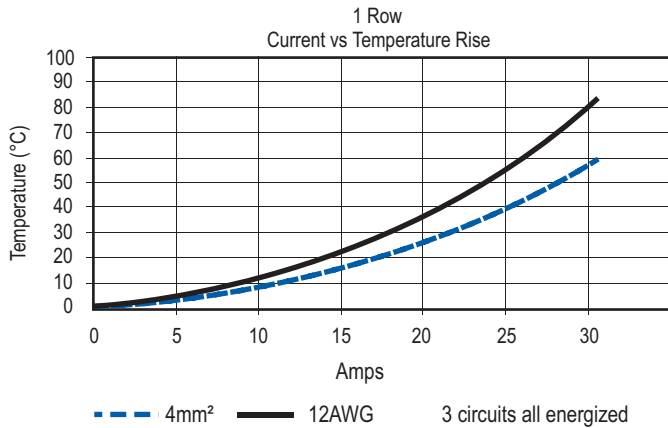

## DIMENSIONS - mm(in.)

### Cable Connector

ROWS CONTACTS	-A-	
	mm	in.
1 - 03	28.5	1.12
1 - 04	33.5	1.32
1 - 06	43.5	1.71
1 - 08	53.5	2.11

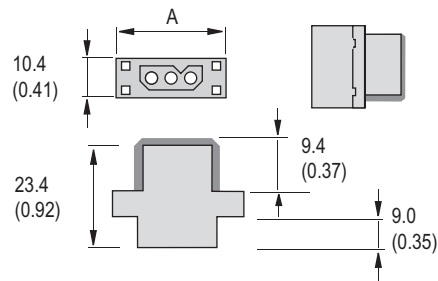

See accessory section for panel clip and mounting clip cut-out dimensions.

## ORDERING INFORMATION

### Cable Connector

Part Number	Description
PM103FOOLOO	1x3 FEMALE Cable Connector
PM104FOOLOO	1x4 FEMALE Cable Connector
PM106FOOLOO	1x6 FEMALE Cable Connector
PM108FOOLOO	1x8 FEMALE Cable Connector

### Panel Mount With Mounting Clip

Part Number	Description
PM103FOOLMC	1x3 FEMALE Cable Connector
PM104FOOLMC	1x4 FEMALE Cable Connector
PM106FOOLMC	1x6 FEMALE Cable Connector
PM108FOOLMC	1x8 FEMALE Cable Connector

### With Clam Shell Hood & Strain Relief

Part Number	Description
PM103FOOLCH	1x3 FEMALE Cable Connector
PM104FOOLCH	1x4 FEMALE Cable Connector
PM106FOOLCH	1x6 FEMALE Cable Connector
PM108FOOLCH	1x8 FEMALE Cable Connector

### Panel Mount With Screws

Part Number	Description
PM103FOOLSC	1x3 FEMALE Cable Connector
PM104FOOLSC	1x4 FEMALE Cable Connector
PM106FOOLSC	1x6 FEMALE Cable Connector
PM108FOOLSC	1x8 FEMALE Cable Connector

### With Snap-in Panel Clip

Part Number	Description
PM103FOOLPC	1x3 FEMALE Cable Connector
PM104FOOLPC	1x4 FEMALE Cable Connector
PM106FOOLPC	1x6 FEMALE Cable Connector
PM108FOOLPC	1x8 FEMALE Cable Connector

### Crimp Contacts

Part Number	Description	Wire	
		AWG	sq. mm
PM16S2024S32	Socket	#24 / 20	0.50 / 0.75
PM16S1620S32	Socket	#20 / 16	0.50 / 1.5
PM16S1416S32	Socket	#16 / 14	1.5 / 2.5
PM16S12S32	Socket	#12	2.5 / 4.0

HEADQUARTERS: Anderson Power Products®, 13 Pratts Junction Road, Sterling, MA 01564-2305 USA T:978-422-3600 F:978-422-3700

EUROPE: Anderson Power Products® Ltd., Unit 3, Europa Court, Europa Boulevard, Westbrook, Warrington, Cheshire, WA5 7TN United Kingdom T: +44 (0) 1925 428390 F: +44 (0) 1925 428399

ASIA / PACIFIC: IDEALAnderson Asia Pacific Ltd., Unit 922-928 Topsail Plaza, 11 On Sum Street, Shatin N.T., Hong Kong T: +(852) 2636 0836 F: +(852) 2635 9036

CHINA: IDEALAnderson Technologies (Shenzhen) Ltd., Block A8 Tantou Western Industrial Park, Songgang Baoan District, Shenzhen, P.R. China 518105 T: +(86) 755 2768 2118 F: +(86) 755 2768 2218

TAIWAN: IDEALAnderson Asia Pacific Ltd., Taiwan Branch, 4F.-2, No.116, Dadun 20th St., Situn District, Taichung City 407, Taiwan (R.O.C.) T: +(886) 4 2310 6451 F: +(886) 4 2310 6460

www.andersonpower.com

# One Row Right Angle PCB (female)

## DIMENSIONS - mm(in.)

### 1 Row - PCB Right Angle Connector

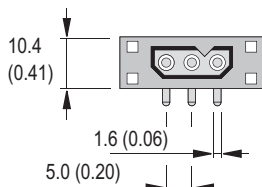
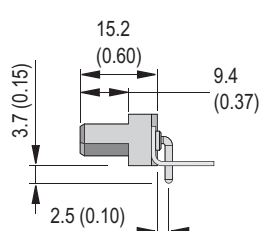
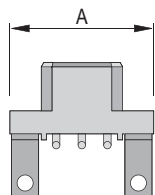
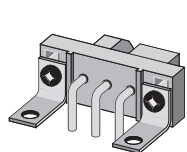

### 1 Row - PCB Hole Layout For Right Angle Connector

ROWS CONTACTS	A		L1		L2	
	mm	in.	mm	in.	mm	in.
1 - 03	28.5	1.12	10	0.39	22.3	0.88
1 - 04	33.5	1.32	15	0.59	27.3	1.07
1 - 06	43.5	1.71	25	0.98	37.3	1.47
1 - 08	53.5	2.11	35	1.38	47.3	1.86

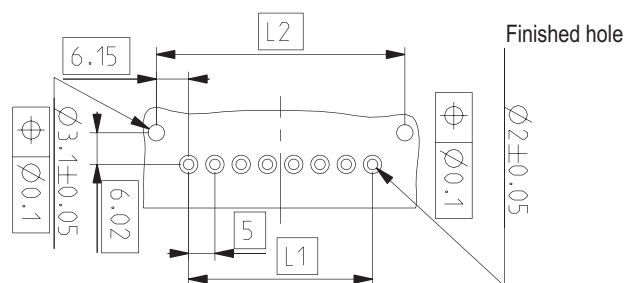

## ORDERING INFORMATION

### With Latch

Part Number	Description
PM103FRALOO	1x3 FEMALE Right Angle PCB Solder
PM104FRALOO	1x4 FEMALE Right Angle PCB Solder
PM106FRALOO	1x6 FEMALE Right Angle PCB Solder
PM108FRALOO	1x8 FEMALE Right Angle PCB Solder

### Snap Bracket & Latch

Part Number	Description
PM103FRALSB	1x3 FEMALE Right Angle PCB Solder
PM104FRALSB	1x4 FEMALE Right Angle PCB Solder
PM106FRALSB	1x6 FEMALE Right Angle PCB Solder
PM108FRALSB	1x8 FEMALE Right Angle PCB Solder

### Bracket With Hole & Latch

Part Number	Description
PM103FRALHB	1x3 FEMALE Right Angle PCB Solder
PM104FRALHB	1x4 FEMALE Right Angle PCB Solder
PM106FRALHB	1x6 FEMALE Right Angle PCB Solder
PM108FRALHB	1x8 FEMALE Right Angle PCB Solder

### No Latch

Part Number	Description
PM103FRAOOO	1x3 FEMALE Right Angle PCB Solder
PM104FRAOOO	1x4 FEMALE Right Angle PCB Solder
PM106FRAOOO	1x6 FEMALE Right Angle PCB Solder
PM108FRAOOO	1x8 FEMALE Right Angle PCB Solder

### Snap Bracket & No Latch

Part Number	Description
PM103FRAOSB	1x3 FEMALE Right Angle PCB Solder
PM104FRAOSB	1x4 FEMALE Right Angle PCB Solder
PM106FRAOSB	1x6 FEMALE Right Angle PCB Solder
PM108FRAOSB	1x8 FEMALE Right Angle PCB Solder

### Bracket With Hole & No Latch

Part Number	Description
PM103FRAOHB	1x3 FEMALE Right Angle PCB Solder
PM104FRAOHB	1x4 FEMALE Right Angle PCB Solder
PM106FRAOHB	1x6 FEMALE Right Angle PCB Solder
PM108FRAOHB	1x8 FEMALE Right Angle PCB Solder

PCB contacts and mounting accessories are designed for a board thickness of 1.60mm (.063) with a contact protrusion of 2.10 (.083). Other contact lengths are available upon request.

# One Row Straight PCB (female)

## DIMENSIONS - mm(in.)

### 1 Row - PCB Straight Solder Connector

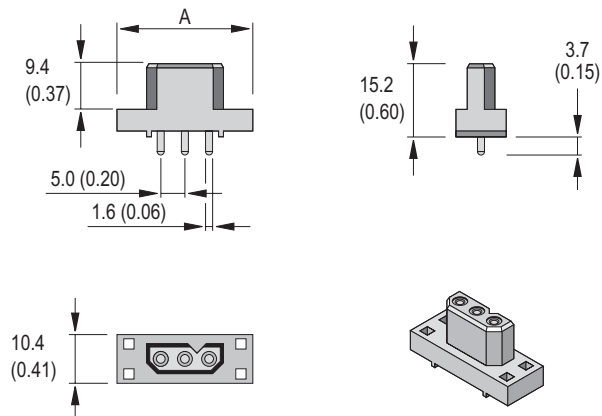

### 1 Row - PCB Hole Layout For Straight Solder Connector

ROWS CONTACTS	A		L1		L2	
	mm	in.	mm	in.	mm	in.
1 - 03	28.5	1.12	10	0.39	22.3	0.88
1 - 04	33.5	1.32	15	0.59	27.3	1.07
1 - 06	43.5	1.71	25	0.98	37.3	1.47
1 - 08	53.5	2.11	35	1.38	47.3	1.86

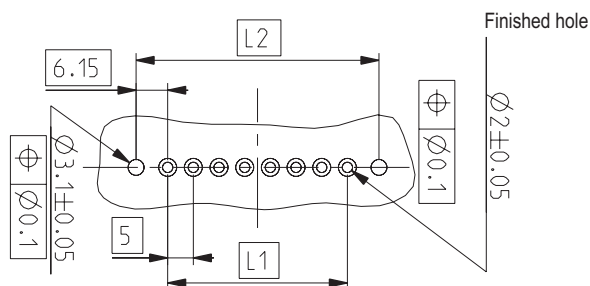

## ORDERING INFORMATION

### With Latch

Part Number	Description
PM103FBALOO	1x3 FEMALE Straight PCB Solder
PM104FBALOO	1x4 FEMALE Straight PCB Solder
PM106FBALOO	1x6 FEMALE Straight PCB Solder
PM108FBALOO	1x8 FEMALE Straight PCB Solder

### No Latch

Part Number	Description
PM103FBAOOO	1x3 FEMALE Straight PCB Solder
PM104FBAOOO	1x4 FEMALE Straight PCB Solder
PM106FBAOOO	1x6 FEMALE Straight PCB Solder
PM108FBAOOO	1x8 FEMALE Straight PCB Solder

### Push On PCB Fastener & Latch

Part Number	Description
PM103FBALSP	1x3 FEMALE Straight PCB Solder
PM104FBALSP	1x4 FEMALE Straight PCB Solder
PM106FBALSP	1x6 FEMALE Straight PCB Solder
PM108FBALSP	1x8 FEMALE Straight PCB Solder

### Push On PCB Fastener & No Latch

Part Number	Description
PM103FBAOSP	1x3 FEMALE Straight PCB Solder
PM104FBAOSP	1x4 FEMALE Straight PCB Solder
PM106FBAOSP	1x6 FEMALE Straight PCB Solder
PM108FBAOSP	1x8 FEMALE Straight PCB Solder

### Self-tapping Screws For PCB Mount & Latch

Part Number	Description
PM103FBALST	1x3 FEMALE Straight PCB Solder
PM104FBALST	1x4 FEMALE Straight PCB Solder
PM106FBALST	1x6 FEMALE Straight PCB Solder
PM108FBALST	1x8 FEMALE Straight PCB Solder

### Self-tapping Screws For PCB Mount & No Latch

Part Number	Description
PM103FBAOST	1x3 FEMALE Straight PCB Solder
PM104FBAOST	1x4 FEMALE Straight PCB Solder
PM106FBAOST	1x6 FEMALE Straight PCB Solder
PM108FBAOST	1x8 FEMALE Straight PCB Solder

PCB contacts and mounting accessories are designed for a board thickness of 1.60mm (.063) with a contact protrusion of 2.10 (.083). Other contact lengths are available upon request.

All Data Subject To Change Without Notice

DS-PM1RF REV09

# Mouser Electronics

Authorized Distributor

Click to View Pricing, Inventory, Delivery & Lifecycle Information:

[Anderson Power Products:](#)

[PM104FBALSP](#)



Компания «ЭлектроПласт» предлагает заключение долгосрочных отношений при поставках импортных электронных компонентов на взаимовыгодных условиях!

Наши преимущества:

- Оперативные поставки широкого спектра электронных компонентов отечественного и импортного производства напрямую от производителей и с крупнейших мировых складов;
- Поставка более 17-ти миллионов наименований электронных компонентов;
- Поставка сложных, дефицитных, либо снятых с производства позиций;
- Оперативные сроки поставки под заказ (от 5 рабочих дней);
- Экспресс доставка в любую точку России;
- Техническая поддержка проекта, помощь в подборе аналогов, поставка прототипов;
- Система менеджмента качества сертифицирована по Международному стандарту ISO 9001;
- Лицензия ФСБ на осуществление работ с использованием сведений, составляющих государственную тайну;
- Поставка специализированных компонентов (Xilinx, Altera, Analog Devices, Intersil, Interpoint, Microsemi, Aeroflex, Peregrine, Syfer, Eurofarad, Texas Instrument, Miteq, Cobham, E2V, MA-COM, Hittite, Mini-Circuits, General Dynamics и др.);

Помимо этого, одним из направлений компании «ЭлектроПласт» является направление «Источники питания». Мы предлагаем Вам помощь Конструкторского отдела:

- Подбор оптимального решения, техническое обоснование при выборе компонента;
- Подбор аналогов;
- Консультации по применению компонента;
- Поставка образцов и прототипов;
- Техническая поддержка проекта;
- Защита от снятия компонента с производства.



#### Как с нами связаться

**Телефон:** 8 (812) 309 58 32 (многоканальный)

**Факс:** 8 (812) 320-02-42

**Электронная почта:** [org@eplast1.ru](mailto:org@eplast1.ru)

**Адрес:** 198099, г. Санкт-Петербург, ул. Калинина, дом 2, корпус 4, литера А.