



## **SMT inductors**

SIMID series, SIMID 2220-H

**Series/Type:** B82442H

**Date:** October 2012

SMD

Size 2220 (EIA) or 5650 (IEC)  
Rated inductance 1 ... 10000  $\mu$ H  
Rated current 35 ... 2500 mA



### Construction

- Upright ferrite drum core
- Laser-welded winding
- Flame-retardant molding

### Features

- Temperature range up to +150 °C
- Current handling capability up to 2.5 A
- High L values
- Qualified to AEC-Q200
- Suitable for lead-free reflow soldering as referenced in JEDEC J-STD 020D
- RoHS-compatible

### Applications

- Filtering of supply voltages, coupling, decoupling
- DC/DC converters
- Automotive electronics
- Telecommunications
- Consumer electronics
- Industrial electronics

### Terminals

- Base material CuSn6
- Layer composition Cu, Ag, Sn (lead-free)<sup>1)</sup>
- Electro-plated

### Marking

- Marking on component:  
Manufacturer, L value (in nH),  
tolerance of L value (coded), date of manufacture (YWWD)
- Minimum data on reel:  
Manufacturer, ordering code, L value, quantity, date of packing

### Delivery mode and packing unit

- 12-mm blister tape, wound on 330-mm  $\varnothing$  reel
- Packing unit: 1500 pcs./reel

<sup>1)</sup> Ni-barrier-plated terminals on request (B82442H\*50).

**SIMID 2220-H**

**SMD**

**Dimensional drawing and layout recommendation**

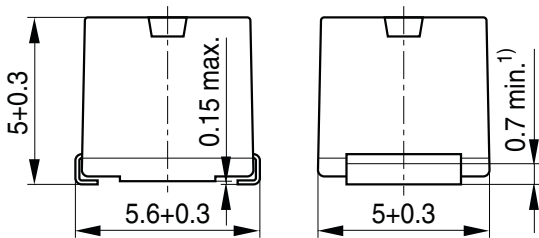

A	B	C	D
4.5	2.0	4.0	8.0

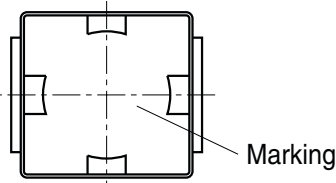

1) Soldering area

IND0088-3-E

Dimensions in mm

**Taping and packing**

Blister tape

Reel

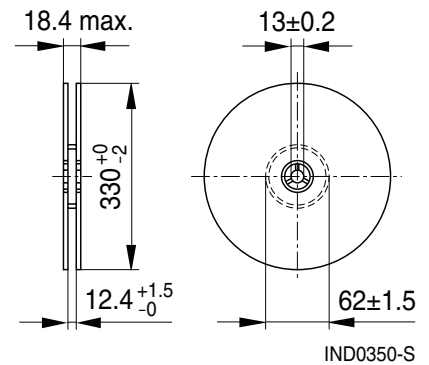
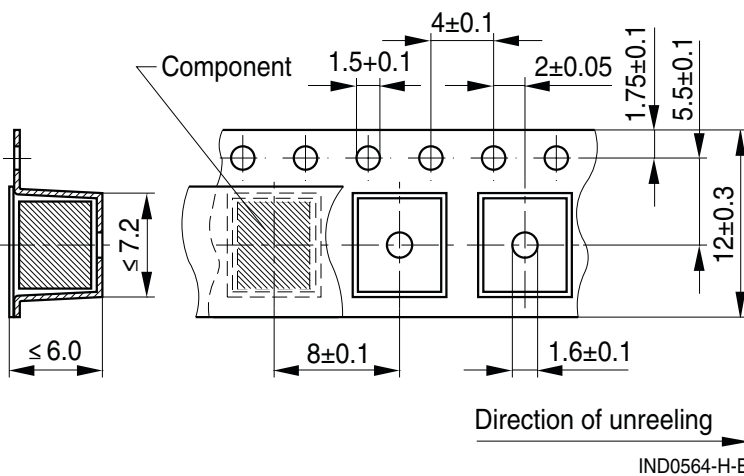

Dimensions in mm

**SMD**
**Technical data and measuring conditions**

Rated inductance $L_R$	Measured with impedance analyzer Agilent 4294A at frequency $f_L$ , 0.1 V, +20 °C
Q factor $Q_{\min}$	Measured with impedance analyzer Agilent 4294A at frequency $f_Q$ , +20 °C
Rated temperature $T_R$	+85 °C
Rated current $I_R$	Maximum permissible DC with inductance decrease $L/L_0 \leq 10\%$ and temperature increase of $\leq 40$ K at rated temperature
Self-resonance frequency $f_{\text{res},\min}$	Measured with impedance analyzer Agilent 4294A, +20 °C
DC resistance $R_{\max}$	Measured at +20 °C
Solderability (lead-free)	Sn95.5Ag3.8Cu0.7: +(245 ±5) °C, (5 ±0.3) s Wetting of soldering area $\geq 90\%$ (based on IEC 60068-2-58)
Resistance to soldering heat	+260 °C, 40 s (as referenced in JEDEC J-STD 020D)
Climatic category	55/150/56 (to IEC 60068-1)
Storage conditions	Mounted: -55 °C ... +150 °C Packaged: -25 °C ... +40 °C, $\leq 75\%$ RH
Weight	Approx. 0.4 g

**Characteristics and ordering codes**

L <sub>R</sub> μH	Tolerance	Q <sub>min</sub>	f <sub>L</sub> ; f <sub>Q</sub> MHz	I <sub>R</sub> mA	R <sub>max</sub> Ω	f <sub>res,min</sub> MHz	Ordering code <sup>1)2)</sup>
1.0	±10% △ K	10	7.96	2500	0.024	95	B82442H1102K000
1.2		10	7.96	2350	0.028	70	B82442H1122K000
1.5		10	7.96	2200	0.032	55	B82442H1152K000
1.8		10	7.96	2000	0.040	47	B82442H1182K000
2.2		10	7.96	1800	0.048	42	B82442H1222K000
2.7		10	7.96	1700	0.056	37	B82442H1272K000
3.3		10	7.96	1550	0.064	34	B82442H1332K000
3.9		10	7.96	1450	0.072	32	B82442H1392K000
4.7		10	7.96	1350	0.088	29	B82442H1472K000
5.6		10	7.96	1250	0.104	26	B82442H1562K000
6.8		10	7.96	1130	0.120	24	B82442H1682K000
8.2		10	7.96	1050	0.144	22	B82442H1822K000
10		10	2.52	1000	0.168	19	B82442H1103K000
12		10	2.52	880	0.20	17	B82442H1123K000
15		10	2.52	810	0.24	16	B82442H1153K000
18		10	2.52	740	0.29	14	B82442H1183K000
22		10	2.52	670	0.35	13	B82442H1223K000
27		10	2.52	620	0.42	11.5	B82442H1273K000
33	±5% △ J	10	2.52	560	0.50	10.5	B82442H1333+000
39	±10% △ K	10	2.52	520	0.58	9.5	B82442H1393+000
47		10	2.52	480	0.68	8.5	B82442H1473+000
56		10	2.52	430	0.80	7.8	B82442H1563+000
68		10	2.52	400	0.96	7.0	B82442H1683+000
82		10	2.52	380	1.12	6.4	B82442H1823+000
100		20	0.796	350	1.28	6.0	B82442H1104+000
120		20	0.796	320	1.52	5.4	B82442H1124+000
150		20	0.796	290	1.76	4.8	B82442H1154+000

Closer tolerances on request.

Higher currents possible at temperatures <T<sub>R</sub> on request.

Sample kit available. Ordering code: B82442X001

For more information refer to chapter "Sample kits".

1) Replace the + by the code letter for the required inductance tolerance.

2) For Ni-barrier-plated terminals replace the last two digits "00" by "50".

**Characteristics and ordering code**

$L_R$ $\mu\text{H}$	Tolerance	$Q_{\min}$	$f_L; f_Q$ MHz	$I_R$ mA	$R_{\max}$ $\Omega$	$f_{\text{res,min}}$ MHz	Ordering code <sup>1)2)</sup>
180	$\pm 5\% \triangleq J$	20	0.796	270	2.24	4.4	B82442H1184+000
220	$\pm 10\% \triangleq K$	20	0.796	240	2.72	3.9	B82442H1224+000
270		20	0.796	220	3.36	3.6	B82442H1274+000
330		20	0.796	200	3.92	3.2	B82442H1334+000
390		20	0.796	180	4.64	2.9	B82442H1394+000
470		20	0.796	170	5.60	2.6	B82442H1474+000
560		20	0.796	150	6.80	2.4	B82442H1564+000
680		20	0.796	140	8.00	2.2	B82442H1684+000
820		20	0.796	130	10.4	2.0	B82442H1824+000
1000		30	0.252	120	12.0	1.8	B82442H1105+000
1200		30	0.252	105	13.6	1.5	B82442H1125+000
1500		30	0.252	100	16.0	1.4	B82442H1155+000
1800		30	0.252	85	24.0	1.3	B82442H1185+000
2200		30	0.252	75	28.0	1.2	B82442H1225+000
2700		30	0.252	65	44.0	1.1	B82442H1275+000
3300		30	0.252	55	48.0	1.0	B82442H1335+000
3900		30	0.252	53	56.0	1.0	B82442H1395+000
4700		30	0.252	50	62.4	0.9	B82442H1475+000
5600		30	0.252	46	68.0	0.8	B82442H1565+000
6800		30	0.252	42	88.0	0.7	B82442H1685+000
8200		30	0.252	39	100	0.6	B82442H1825+000
10000		30	0.0796	35	120	0.5	B82442H1106+000

Closer tolerances on request.

Higher currents possible at temperatures  $< T_R$  on request.

Sample kit available. Ordering code: B82442X001

For more information refer to chapter "Sample kits".

1) Replace the + by the code letter for the required inductance tolerance.

2) For Ni-barrier-plated terminals replace the last two digits "00" by "50".

**SMD**

**Impedance  $|Z|$  versus frequency  $f$**   
measured with impedance analyzer Agilent 4294A/E4991A, typical values at +20 °C



**Inductance  $L$  versus DC load current  $I_{DC}$**   
measured with LCR meter Agilent 4285A, typical values at +20 °C

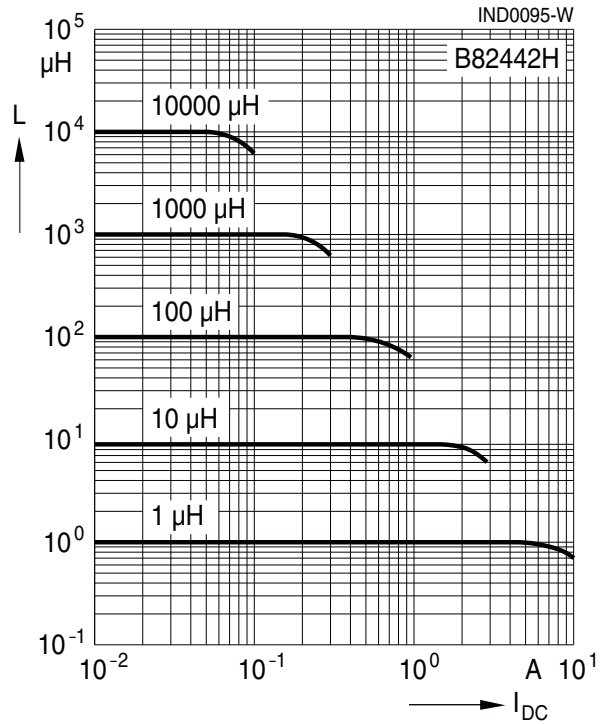

**Q factor versus frequency  $f$**   
measured with impedance analyzer Agilent 4294A/E4991A, typical values at +20 °C

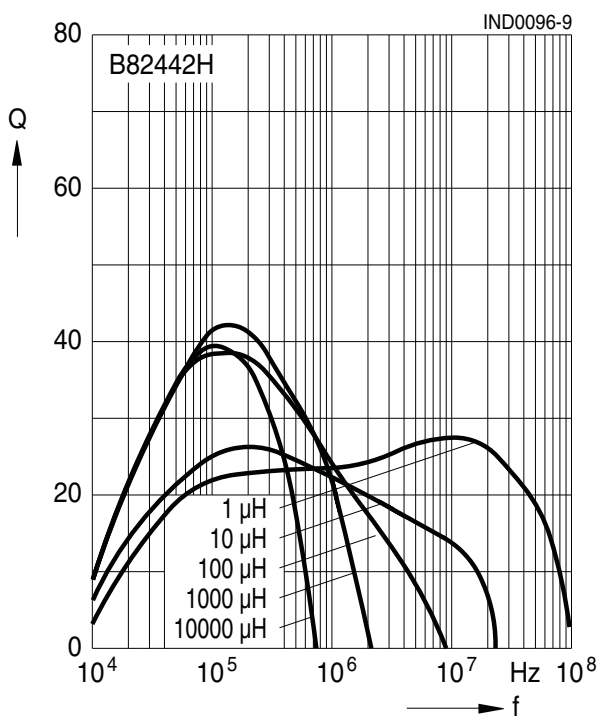

**Current derating  $I_{op}/I_R$  versus ambient temperature  $T_A$**   
(rated temperature  $T_R = +85$  °C)

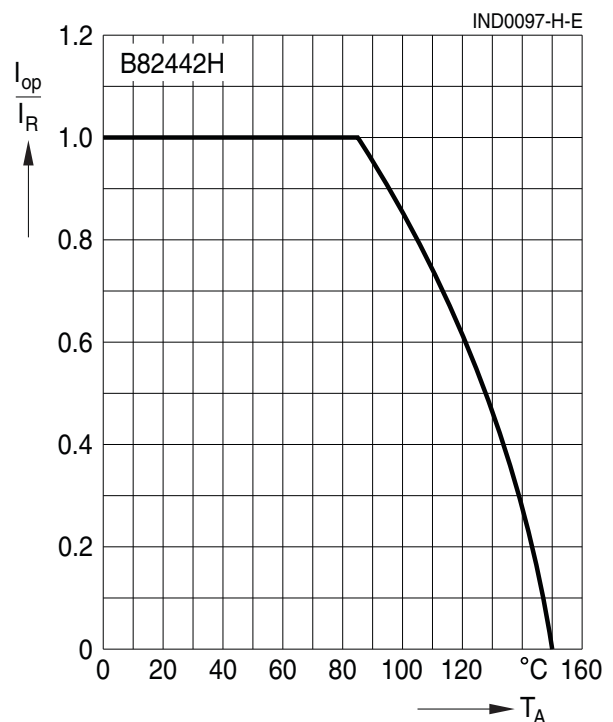

## Cautions and warnings

- Please note the recommendations in our Inductors data book (latest edition) and in the data sheets.
  - Particular attention should be paid to the derating curves given there.
  - The soldering conditions should also be observed. Temperatures quoted in relation to wave soldering refer to the pin, not the housing.
- If the components are to be washed varnished it is necessary to check whether the washing varnish agent that is used has a negative effect on the wire insulation, any plastics that are used, or on glued joints. In particular, it is possible for washing varnish agent residues to have a negative effect in the long-term on wire insulation.  
Washing processes may damage the product due to the possible static or cyclic mechanical loads (e.g. ultrasonic cleaning). They may cause cracks to develop on the product and its parts, which might lead to reduced reliability or lifetime.
- The following points must be observed if the components are potted in customer applications:
  - Many potting materials shrink as they harden. They therefore exert a pressure on the plastic housing or core. This pressure can have a deleterious effect on electrical properties, and in extreme cases can damage the core or plastic housing mechanically.
  - It is necessary to check whether the potting material used attacks or destroys the wire insulation, plastics or glue.
  - The effect of the potting material can change the high-frequency behaviour of the components.
- Ferrites are sensitive to direct impact. This can cause the core material to flake, or lead to breakage of the core.
- Even for customer-specific products, conclusive validation of the component in the circuit can only be carried out by the customer.



## Important notes

The following applies to all products named in this publication:

1. Some parts of this publication contain **statements about the suitability of our products for certain areas of application**. These statements are based on our knowledge of typical requirements that are often placed on our products in the areas of application concerned. We nevertheless expressly point out **that such statements cannot be regarded as binding statements about the suitability of our products for a particular customer application**. As a rule, EPCOS is either unfamiliar with individual customer applications or less familiar with them than the customers themselves. For these reasons, it is always ultimately incumbent on the customer to check and decide whether an EPCOS product with the properties described in the product specification is suitable for use in a particular customer application.
2. We also point out that **in individual cases, a malfunction of electronic components or failure before the end of their usual service life cannot be completely ruled out in the current state of the art, even if they are operated as specified**. In customer applications requiring a very high level of operational safety and especially in customer applications in which the malfunction or failure of an electronic component could endanger human life or health (e.g. in accident prevention or life-saving systems), it must therefore be ensured by means of suitable design of the customer application or other action taken by the customer (e.g. installation of protective circuitry or redundancy) that no injury or damage is sustained by third parties in the event of malfunction or failure of an electronic component.
3. **The warnings, cautions and product-specific notes must be observed.**
4. In order to satisfy certain technical requirements, **some of the products described in this publication may contain substances subject to restrictions in certain jurisdictions (e.g. because they are classed as hazardous)**. Useful information on this will be found in our Material Data Sheets on the Internet ([www.epcos.com/material](http://www.epcos.com/material)). Should you have any more detailed questions, please contact our sales offices.
5. We constantly strive to improve our products. Consequently, **the products described in this publication may change from time to time**. The same is true of the corresponding product specifications. Please check therefore to what extent product descriptions and specifications contained in this publication are still applicable before or when you place an order.

We also **reserve the right to discontinue production and delivery of products**. Consequently, we cannot guarantee that all products named in this publication will always be available. The aforementioned does not apply in the case of individual agreements deviating from the foregoing for customer-specific products.

6. Unless otherwise agreed in individual contracts, **all orders are subject to the current version of the “General Terms of Delivery for Products and Services in the Electrical Industry” published by the German Electrical and Electronics Industry Association (ZVEI)**.
7. The trade names EPCOS, BAOKE, Alu-X, CeraDiode, CeraLink, CSMP, CSSP, CTVS, DeltaCap, DigiSiMic, DSSP, FilterCap, FormFit, MiniBlue, MiniCell, MKD, MKK, MLSC, MotorCap, PCC, PhaseCap, PhaseCube, PhaseMod, PhiCap, SIFERRIT, SIFI, SIKOREL, SilverCap, SIMDAD, SiMic, SIMID, SineFormer, SIOV, SIP5D, SIP5K, ThermoFuse, WindCap are **trademarks registered or pending** in Europe and in other countries. Further information will be found on the Internet at [www.epcos.com/trademarks](http://www.epcos.com/trademarks).



Компания «ЭлектроПласт» предлагает заключение долгосрочных отношений при поставках импортных электронных компонентов на взаимовыгодных условиях!

Наши преимущества:

- Оперативные поставки широкого спектра электронных компонентов отечественного и импортного производства напрямую от производителей и с крупнейших мировых складов;
- Поставка более 17-ти миллионов наименований электронных компонентов;
- Поставка сложных, дефицитных, либо снятых с производства позиций;
- Оперативные сроки поставки под заказ (от 5 рабочих дней);
- Экспресс доставка в любую точку России;
- Техническая поддержка проекта, помощь в подборе аналогов, поставка прототипов;
- Система менеджмента качества сертифицирована по Международному стандарту ISO 9001;
- Лицензия ФСБ на осуществление работ с использованием сведений, составляющих государственную тайну;
- Поставка специализированных компонентов (Xilinx, Altera, Analog Devices, Intersil, Interpoint, Microsemi, Aeroflex, Peregrine, Syfer, Eurofarad, Texas Instrument, Miteq, Cobham, E2V, MA-COM, Hittite, Mini-Circuits, General Dynamics и др.);

Помимо этого, одним из направлений компании «ЭлектроПласт» является направление «Источники питания». Мы предлагаем Вам помощь Конструкторского отдела:

- Подбор оптимального решения, техническое обоснование при выборе компонента;
- Подбор аналогов;
- Консультации по применению компонента;
- Поставка образцов и прототипов;
- Техническая поддержка проекта;
- Защита от снятия компонента с производства.



#### Как с нами связаться

**Телефон:** 8 (812) 309 58 32 (многоканальный)

**Факс:** 8 (812) 320-02-42

**Электронная почта:** [org@eplast1.ru](mailto:org@eplast1.ru)

**Адрес:** 198099, г. Санкт-Петербург, ул. Калинина, дом 2, корпус 4, литера А.