

# SB® 350 Connectors - up to 500 Amps



The SB®350 is the largest connector in the series with power capabilities up to 450 amps with 4/0 AWG wire and 500 amps with a 350 mcm wire. Wires ranging from #1/0 (53.5 mm<sup>2</sup>) to 350 mcm (150 mm<sup>2</sup>) fit into the one piece housing available in standard PC or a chemical resistant PBT/PC blend. Silver plated wire or busbar contacts minimize electrical resistance while offering supreme durability and reliability.

- **Up to 350 mcm (150 mm<sup>2</sup>) Wires**  
*Allows UL rated currents up to 500 amps*
- **Chemical Resistant Housing Option**  
*Extends temperature range down to -40°C, while offering enhanced UV and chemical resistance*
- **Same Housings Used for Wire and Busbar Contacts**  
*Enables color-coded mechanically keyed wire to busbar connections*

## | SB®350 ORDERING INFORMATION |

### SB®350 Standard Housings

The largest SB® housings work with wire contacts up to 350 mcm [150 mm<sup>2</sup>] as well as busbar contacts. GerBottom View derless design mates with itself. Mechanical keys are color coded. NOTE: SB®350 Black and Blue Housings have the same keying features and can be intermated.

Description	--- Part Numbers ---	
Minimum Quantity .....	50	25 ...
Yellow	914-BK	914
Orange	932-BK	932
Red	913-BK	913
Gray	906-BK	906
Blue	912-BK	912
Green	931-BK	931
Black	2-7250G8	-

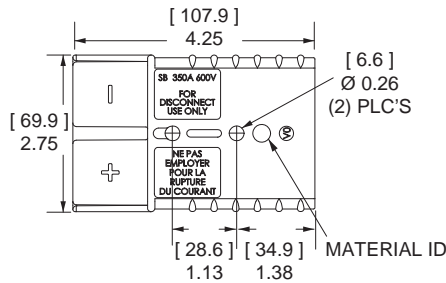

P = Chemical Resistant

### SB®350 Chemical Resistant Housings

Same features as the Standard SB®350 but molded in a chemical resistant PBT/ PC blend. Suitable for use to -40°C.

Description	--- Part Numbers ---	
Minimum Quantity .....	50	25 ....
Red	P913-BK	P913
Gray	P906-BK	P906

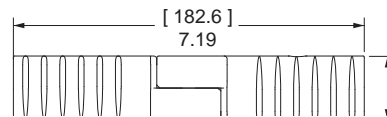

Mated Length

### SB®350 Silver Plated Wire Contacts

Silver plated contacts offer superior electrical performance and durability up to 10,000 mating cycles. See reducing bushings in accessory section for smaller wires.

AWG	mm <sup>2</sup>	Mating Force	Dimensions			- A -		- B -		- C -	
			- Loose Piece Part Numbers -			inches	mm	inches	mm	inches	mm
			200	150	50						
300mcm	152	High	-	910-BK	910 *	0.75	19.05	0.87	22.10	3.04	77.2
4/0	107.2	High	908-BK	-	908 *	0.64	16.26	0.75	19.05	3.03	77.0
3/0	85	High	916-BK	-	916 *	0.58	14.73	0.70	17.78	3.00	76.2
2/0	67.4	High	907-BK	-	907 *	0.49	12.45	0.64	16.26	2.96	75.2
1/0	53.5	High	917-BK	-	917 *	0.44	11.18	0.51	12.95	2.91	73.9

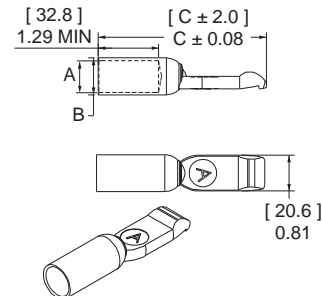

\* Sold as pairs. 2 parts shipped for every 1 part ordered.

© 2018 Anderson Power Products, Inc. All rights reserved. APP®, Anderson Power Products®, A®, SB® and the APP Logo are registered trademarks of Anderson Power Products, Inc.

## SB®350 Silver Plated Busbar Contacts

Use 2 busbar contacts per housing to provide a quick disconnect input or output busbar connection. Busbar contacts are for mating with wire contacts only. Part number 350BBS includes lock nuts. Locknuts must be ordered separately for B01998P1.

Type	Thread	Mating Force	- Loose Piece Part Numbers -	
Minimum Quantity			50	10
Busbar	3/8-16	High	B01998P1	350BBS
Lock Nut	3/8-16	-	H1216P9	110G73

NOTE: Has not been tested by UL.

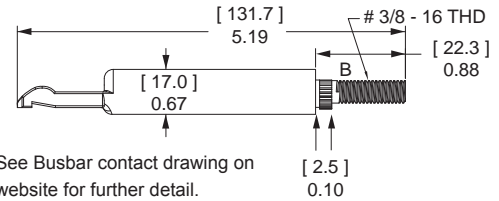

See Busbar contact drawing on website for further detail.

## SB® 350 CONNECTOR SPECIFICATIONS |

Electrical		
<b>Current Rating Amperes</b> <sup>1</sup>	<b>UL 1977</b>	<b>CSA</b>
Wire to Wire (4/0 AWG)	450	
Wire to Wire (350 mcm)	500	325
<b>Voltage Rating AC/DC</b>		
UL 1977	600	
<b>Dielectric Withstanding Voltage</b>		
Volts AC	2,200	
<b>Avg. Mated Contact Resistance Milliohms</b> <sup>1</sup>		
2 1/2" of 300mcm wire	0.050	
<b>Hot Plug Current Rating Amperes - Wire &amp; Busbar</b>		
250 cycles at 120V DC	100A	

Mechanical		
<b>Wire Size Range</b>	<b>AWG</b>	<b>mm<sup>2</sup></b>
Wire Contacts with Bushings	1/0 to 350 mcm	53.5 to 150
<b>Max. Wire Insulation Diameter</b>	<b>in.</b>	<b>mm</b>
	1.100	27.900
<b>Operating Temperature</b> <sup>2</sup>	<b>°F</b>	<b>°C</b>
Standard	-4° to 221°	-20° to 105°
Chemical Resistant	-40 to 221°	-40° to 105°
<b>Mating Cycles No Load by Plating</b>	<b>Silver (Ag)</b>	
Wire and Busbar Contacts	10,000	
<b>Avg. Mating / Unmating Force</b>	<b>Lbf.</b>	<b>N</b>
2 Pole	30	133
<b>Min. Contact / Spring Retention Force</b>		
lbf	150	
N	667	

Materials	
<b>Housing</b>	
Standard Plastic Resin	Polycarbonate
Chem. Resistant Resin	Polycarbonate / PBT blend
Contact Retention Spring	Stainless Steel
<b>Housing Flammability Rating</b>	
UL94	V-0
Glow Wire	960°C (GWFI) / 800°C (GWIT)
<b>Wire &amp; Busbar Contacts</b> <sup>4</sup>	
Base	Copper Alloy
Plating	Silver
<b>Contact Termination Methods</b>	
Crimp <sup>3</sup>	Wire Contacts
Hand Solder	Wire Contacts
Wrench / Socket	Busbar Contacts

NOTE 1: See IEC 60664-1 for working voltage.

<sup>1</sup> Based on: 105°C rated or better cable of the largest size, Properly calibrated APP recommended tooling, and a 25°C ambient temperature. UL rating not to exceed the maximum operating temperature. CSA rating below a 30°C temperature rise.

<sup>2</sup> Limited by the thermal properties of the connector plastic housing.

<sup>3</sup> Use APP recommended tooling only. Alternate tools may adversely affect the performance of our connectors along with UL and CSA recognition.

<sup>4</sup> Has not been tested by UL.



## | IEC INFORMATION |

Connector Series	Configurations	Creepage/Clearance per IEC 60950-1	Material Group
SB®350	Unmated	5.66 mm	IIa
	Mated	5.66 mm	

Attributes	SB350
<b>AMP Rating AC/DC</b>	350
<b>Voltage Rating AC/DC (Steady State)</b>	500 V AC/DC (Operational)
<b>Breaking Capacity - AMP Rating /Cycles</b>	100 Amp / 10 cycles
<b>Voltage Rating (Breaking Capacity)</b>	125 VDC
Finger Safety - Mated only	IEC 60529 - IP20
Wire Size tested	120 mm <sup>2</sup>
Contact Series Tested	908
Climatic Testing (Cold, Heat & MFG)	IEC 60512 Test -11j, 11i & 11g,
Cycle Life	IEC 60512 Test 9a - 5000 Cycles
Mechanical Strength Impact	IEC 60512-5 @ 29.5 Inches - dropped 8 times
Temperature Range	-20 °C to 105 °C -4 °F to 221 °F

Protection
<b>Touch Safety with Wire Contacts</b>
IEC 60529
IP10

NOTE 2: Refer to the Constructional Data form for additional information on our website., [www.andersonpower.com](http://www.andersonpower.com)



# SB® 350 CONNECTOR TEMPERATURE CHARTS | Temperature rise charts are based on a 25°C ambient temperature.

For Temperature Rise Above 60°C, Consult the Extended Temperature Rise Charts in the Appropriate Product Section on the Website.

Current - Temperature Derating per IEC 60512-5-2 Test 5B

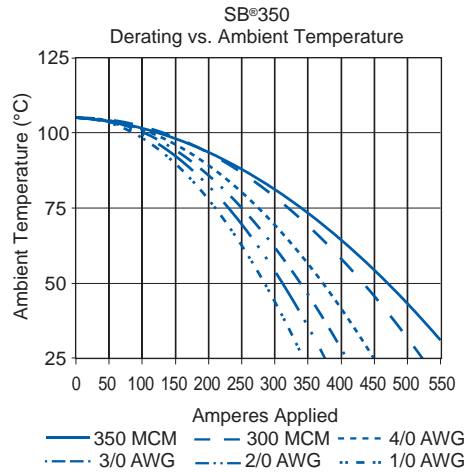
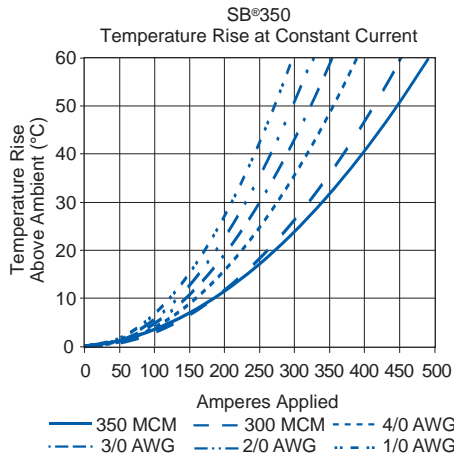

## SB® 350 ACCESSORIES

### Cable Clamps

Durable metal cable clamps securely hold cables to prevent accidental strain or pulls from dislodging wire or contacts from the housing. Cable clamps are recommended for solder terminated wires.

Description	Cable Size		- Part Numbers -
	Min / Max Inches O.D.	Min / Max mm O.D.	
Minimum Quantity .....			10 .....
Bolt On for Discrete Conductor	1.00 to 0.35	25.4 to 8.8	996G1
Discrete Conductor w/ Integral Handle	0.76 to 0.32	19.3 to 8.2	911

The given wire O.D. information is an estimate. Cable clamps should be evaluated for performance with the actual wire to be used.

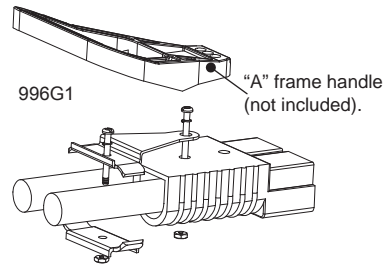

### Handles

Handles are made out of durable PC plastic. Hardware to attach to connector body included in kits.

Description	----- Part Numbers -----	
Minimum Quantity ....	100	25 ...
Gray Handle Kit	-	995G2
Red Handle Kit	-	995G4
Handle Only, Gray	3-5074P1	-
Handle Only, Red	3-5074P3	-
Handle Only, Black	3-5074P5	-
Hardware Bag	-	106G7

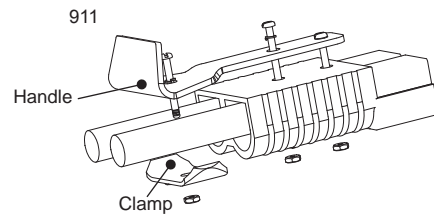
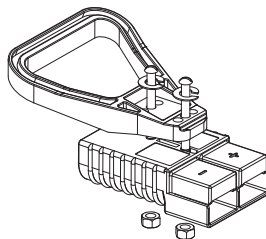

### Dust Cover

Prevents dust and dirt from entering the mating interface of the connector when unmated. NOTE: Not a Hermetic Seal.

Description	----- Part Numbers -----	
Minimum Quantity .....	500	50 ...
Dust Cover with Lanyard Strap, Red	113890P3	134G3

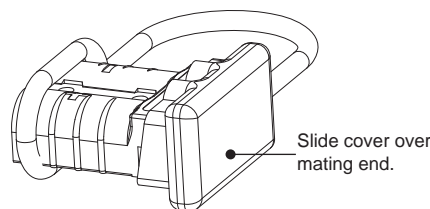

### SB®350 Lockout

Works with standard lockout - tagout equipment to prevent access to the mating interface of the connector. Made from durable PC plastic.

Description	--- Part Number ---	
Minimum Quantity .....	25	.....
Red Lockout - Tagout Kit	SB350-LOCKOUT	

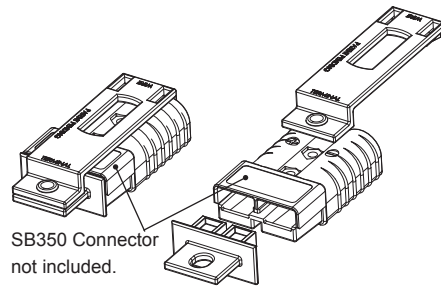

### Manual Release Bracket - Mounting Side

Works with the Locking Side to ease mating and unmating connectors.

Description	----- Part Numbers -----		
Minimum Quantity .....	66	25	10 ...
Bracket and Hardware Kit	-	-	922G1
Bracket Only	B00229P1	-	-
Hardware Bag	-	106G6	-

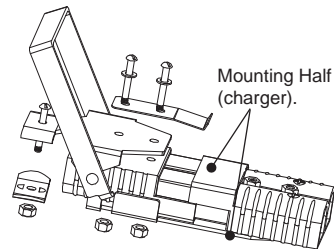

### Manual Release Bracket - Locking Side with Cable Clamp

Works with the Mounting Side to ease mating and unmating connectors.

Description	Cable Size		- Part Numbers -
	Min / Max Inches O.D.	Min / Max mm O.D.	
Minimum Quantity .....			10 .....
Bracket and Hardware Kit w/ Clamp Kit	0.94 to 0.61	23.7 to 15.5	919

The given wire O.D. information is an estimate. Cable clamps should be evaluated for performance with the actual wire to be used.

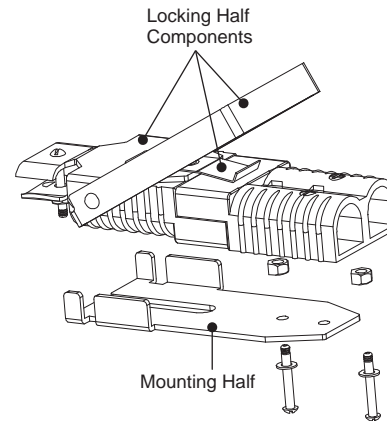

### Manual Release Bracket - Locking Side no Cable Clamp

Works with the Battery side to ease mating and unmating connectors.

Description	- Part Numbers -
Minimum Quantity .....	10 .....
Bracket and Hardware Kit No Clamp Kit	919G1

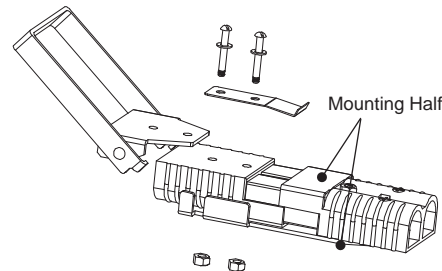

### Reducing Bushings: for Use with Contact # 907

Use with contact part number 907-BK to allow a smaller wire to be used with the connector. Electrical capability is derated with smaller wire.

Contact Barrel Size	Wire Size	--- Part Numbers ---	
Minimum Quantity .....		500	100 ...
2/0 AWG [67.4 mm <sup>2</sup> ]	1/0 AWG [53.5 mm <sup>2</sup> ]	5918-BK	5918

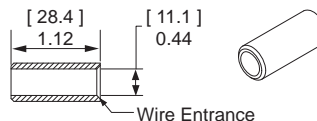

SB®

# - Tooling Information

Wire Size		Loose Piece Part Numbers	Loose Piece Contact Crimp Tools				Number of Crimps
AWG	mm²	Silver Plating	Hand Tool	Pneumatic Bench Tool	Die	Locator	
<b>SB®50</b>							
#6	13.3	1307	1309G4	1387G1	1388G6	1389G6	Single
		5900					
#8	8.4	5952					
#10 / 12	5.3 / 3.3	5953			1388G7	1389G7	
		5915					
<b>SB®120</b>							
#1	42.4	1323G1	1368 Series	1387G1	1388G3	1389G4	Single
#2	33.6	1319			1388G4		
#4	21.2	1319G4					
#6	13.3	1319G6					
<b>SB®175</b>							
1/0	53.5	1382	1368 Series	1387G2	1303G13	1304G32	Double
#1	42.4	1347					
#2	33.6	1383					
#4	21.1	1384					
#6	13.3	1348		1387G1	1388G4	1389G3	Single
<b>SB®350</b>							
300mcm	152	910	1368 Series	1387G2	N/A		Double
4/0	107.2	908			1303G3	1304G31	
3/0	85	916			1303G12		
2/0	67.4	907					
1/0	53.5	917					

NOTE: See website for the most current information.

SECTION 3  
SB®

# Mouser Electronics

Authorized Distributor

Click to View Pricing, Inventory, Delivery & Lifecycle Information:

## Anderson Power Products:

[5918](#) [134G3](#) [2-7250G8](#) [906](#) [912](#) [913](#) [914](#) [919G1](#) [P906](#) [P913](#) [SB350-LOCKOUT](#) [916-BK](#) [917-BK](#) [908-BK](#)  
[913-BK](#) [912-BK](#) [931-BK](#) [932-BK](#) [P906-BK](#)



Компания «ЭлектроПласт» предлагает заключение долгосрочных отношений при поставках импортных электронных компонентов на взаимовыгодных условиях!

Наши преимущества:

- Оперативные поставки широкого спектра электронных компонентов отечественного и импортного производства напрямую от производителей и с крупнейших мировых складов;
- Поставка более 17-ти миллионов наименований электронных компонентов;
- Поставка сложных, дефицитных, либо снятых с производства позиций;
- Оперативные сроки поставки под заказ (от 5 рабочих дней);
- Экспресс доставка в любую точку России;
- Техническая поддержка проекта, помощь в подборе аналогов, поставка прототипов;
- Система менеджмента качества сертифицирована по Международному стандарту ISO 9001;
- Лицензия ФСБ на осуществление работ с использованием сведений, составляющих государственную тайну;
- Поставка специализированных компонентов (Xilinx, Altera, Analog Devices, Intersil, Interpoint, Microsemi, Aeroflex, Peregrine, Syfer, Eurofarad, Texas Instrument, Miteq, Cobham, E2V, MA-COM, Hittite, Mini-Circuits, General Dynamics и др.);

Помимо этого, одним из направлений компании «ЭлектроПласт» является направление «Источники питания». Мы предлагаем Вам помощь Конструкторского отдела:

- Подбор оптимального решения, техническое обоснование при выборе компонента;
- Подбор аналогов;
- Консультации по применению компонента;
- Поставка образцов и прототипов;
- Техническая поддержка проекта;
- Защита от снятия компонента с производства.



#### Как с нами связаться

**Телефон:** 8 (812) 309 58 32 (многоканальный)

**Факс:** 8 (812) 320-02-42

**Электронная почта:** [org@eplast1.ru](mailto:org@eplast1.ru)

**Адрес:** 198099, г. Санкт-Петербург, ул. Калинина, дом 2, корпус 4, литера А.