

CCS020M12CM2

1.2kV, 80 mΩ Silicon Carbide Six-Pack (Three Phase) Module

C2M MOSFET and Z-Rec[®] Diode

V_{DS}	1.2 kV
$E_{sw, Total} @ 20A, 150\text{ }^{\circ}C$	0.48 mJ
$R_{DS(on)}$	80 mΩ

Features

- Ultra Low Loss
- High-Frequency Operation
- Zero Reverse Recovery Current from Diode
- Zero Turn-off Tail Current from MOSFET
- Normally-off, Fail-safe Device Operation
- Ease of Paralleling
- Copper Baseplate and Aluminum Nitride Insulator

System Benefits

- Enables Compact and Lightweight Systems
- High Efficiency Operation
- Mitigates Over-voltage Protection
- Reduced Thermal Requirements
- Reduced System Cost

Applications

- Solar Inverter
- 3-Phase PFC
- Regen Drive
- UPS and SMPS
- Motor Drive

Package



Part Number	Package	Marking
CCS020M12CM2	Six-Pack	CCS020M12CM2

Maximum Ratings ($T_C = 25\text{ }^{\circ}C$ unless otherwise specified)

Symbol	Parameter	Value	Unit	Test Conditions	Notes
V_{DSmax}	Drain - Source Voltage	1.2	kV		
V_{GSmax}	Gate - Source Voltage	-10/+25	V	Absolute maximum values	
V_{GSop}	Gate - Source Voltage	-5/20	V	Recommended operational values	
I_D	Continuous MOSFET Drain Current	29.5	A	$V_{GS} = 20\text{ V}, T_C = 25\text{ }^{\circ}C$	Fig. 25
		20		$V_{GS} = 20\text{ V}, T_C = 90\text{ }^{\circ}C$	
$I_{D(pulse)}$	Pulsed Drain Current	80	A	Pulse width t_p limited by $T_{J(max)}$	
I_F	Continuous Diode Forward Current	46	A	$V_{GS} = -5\text{ V}, T_C = 25\text{ }^{\circ}C$	
		27		$V_{GS} = -5\text{ V}, T_C = 90\text{ }^{\circ}C$	
T_{Jmax}	Junction Temperature	-40 to +150	$^{\circ}C$		
T_C, T_{STG}	Case and Storage Temperature Range	-40 to +125	$^{\circ}C$		
V_{isol}	Case Isolation Voltage	4.5	kV	AC, 50 Hz, 1 min	
L_{Stray}	Stray Inductance	30	nH	Measured between terminals 25, 26 and 27, 28	
P_D	Power Dissipation	167	W	$T_C = 25\text{ }^{\circ}C, T_J = 150\text{ }^{\circ}C$	Fig. 26



Electrical Characteristics ($T_c = 25^\circ\text{C}$ unless otherwise specified)

Symbol	Parameter	Min.	Typ.	Max.	Unit	Test Conditions	Note
$V_{(BR)DSS}$	Drain - Source Breakdown Voltage	1.2			kV	$V_{GS} = 0\text{ V}, I_D = 100\ \mu\text{A}$	
$V_{GS(th)}$	Gate Threshold Voltage	1.7	2.2		V	$V_{DS} = 10\text{ V}, I_D = 1\text{ mA}$	Fig. 7
			1.6			$V_{DS} = 10\text{ V}, I_D = 1\text{ mA}, T_J = 150^\circ\text{C}$	
I_{DSS}	Zero Gate Voltage Drain Current		1	100	μA	$V_{DS} = 1.2\text{ kV}, V_{GS} = 0\text{V}$	
I_{DSS}	Zero Gate Voltage Drain Current		10	250	μA	$V_{DS} = 1.2\text{ kV}, V_{GS} = 0\text{V}, T_J = 150^\circ\text{C}$	
I_{GSS}	Gate-Source Leakage Current		1	250	nA	$V_{GS} = 20\text{ V}, V_{DS} = 0\text{V}$	
$R_{DS(on)}$	On State Resistance		80	98	m Ω	$V_{GS} = 20\text{ V}, I_{DS} = 20\text{ A}$	Fig. 4-6
			145	208		$V_{GS} = 20\text{ V}, I_{DS} = 20\text{ A}, T_J = 150^\circ\text{C}$	
g_{fs}	Transconductance		9.8		S	$V_{DS} = 20\text{ V}, I_{DS} = 20\text{ A}$	Fig. 8
			8.5			$V_{DS} = 20\text{ V}, I_D = 20\text{ A}, T_J = 150^\circ\text{C}$	
C_{iss}	Input Capacitance		900		pF	$V_{DS} = 800\text{ V}, f = 1\text{ MHz}, V_{AC} = 25\text{ mV}$	Fig. 16,17
C_{oss}	Output Capacitance		181				
C_{rss}	Reverse Transfer Capacitance		5.9				
E_{on}	Turn-On Switching Energy		0.41		mJ	$V_{DD} = 800\text{ V}, V_{GS} = -5\text{V}/+20\text{V}$ $I_D = 20\text{ A}, R_{G(ext)} = 2.5\ \Omega$ Load = 412 $\mu\text{H}, T_J = 150^\circ\text{C}$ Note: IEC 60747-8-4 Definitions	Fig. 22
E_{off}	Turn-Off Switching Energy		0.07		mJ		
$R_{G(int)}$	Internal Gate Resistance		3.8		Ω	$f = 1\text{ MHz}, V_{AC} = 25\text{ mV}$	
Q_{GS}	Gate-Source Charge		16.1		nC	$V_{DD} = 800\text{ V}, V_{GS} = -5\text{V}/+20\text{V},$ $I_D = 20\text{ A},$ Per JEDEC24 pg 27	Fig. 15
Q_{GD}	Gate-Drain Charge		20.7				
Q_G	Total Gate Charge		61.5				
$t_{d(on)}$	Turn-on delay time		10		ns	$V_{DD} = 800\text{V}, V_{GS} = -5/+20\text{V},$ $I_D = 20\text{ A}, R_{G(ext)} = 2.5\ \Omega,$ Timing relative to V_{DS} Note: IEC 60747-8-4, pg 83 Resistive load	Fig. 24
$t_{r(on)}$	V_{SD} fall time 90% to 10%		14		ns		
$t_{d(off)}$	Turn-off delay time		22.4		ns		
$t_{r(off)}$	V_{SD} rise time 10% to 90%		53		ns		
V_{SD}	Diode Forward Voltage		1.5	1.7	V	$I_F = 20\text{ A}, V_{GS} = 0, T_J = 25^\circ\text{C}$	Fig. 10
			1.8	2.3		$I_F = 20\text{ A}, V_{GS} = 0, T_J = 150^\circ\text{C}$	Fig. 11
Q_C	Total Capacitive Charge		0.27		μC	$I_{SD} = 20\text{ A}, V_{DS} = 800\text{V}$ $di/dt = 1500\text{ A}/\mu\text{s}, V_{GS} = -5\text{V}$	

Thermal Characteristics

Symbol	Parameter	Min.	Typ.	Max.	Unit	Test Conditions	Note
R_{thJCM}	Thermal Resistance Junction-to-Case for MOSFET		0.7	0.75	$^\circ\text{C}/\text{W}$		Fig. 27
R_{thJCD}	Thermal Resistance Junction-to-Case for Diode		0.8	0.85			Fig. 28

Additional Module Data

Symbol	Condition	Max.	Unit	Test Condition
W	Weight	180	g	
M	Mounting Torque	5.0	Nm	To Heatsink and terminals
	Clearance Distance	14.09	mm	Terminal to terminal
	Creepage Distance	14.11	mm	Terminal to terminal
		17.46	mm	Terminal to baseplate

Typical Performance

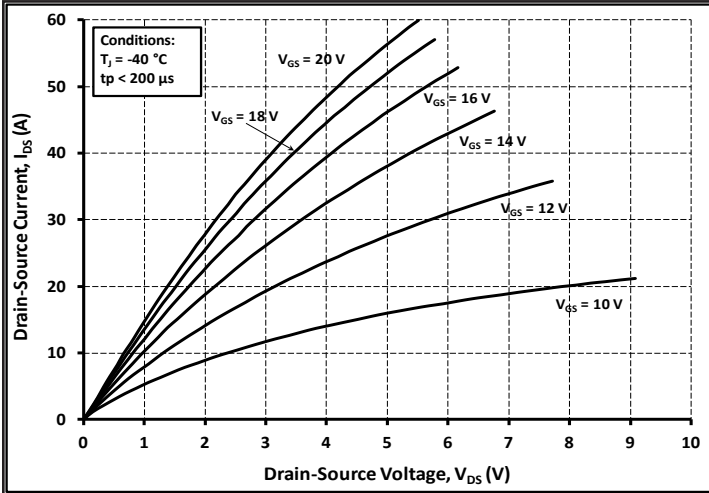

Figure 1. Output Characteristics $T_j = -40\text{ }^\circ\text{C}$

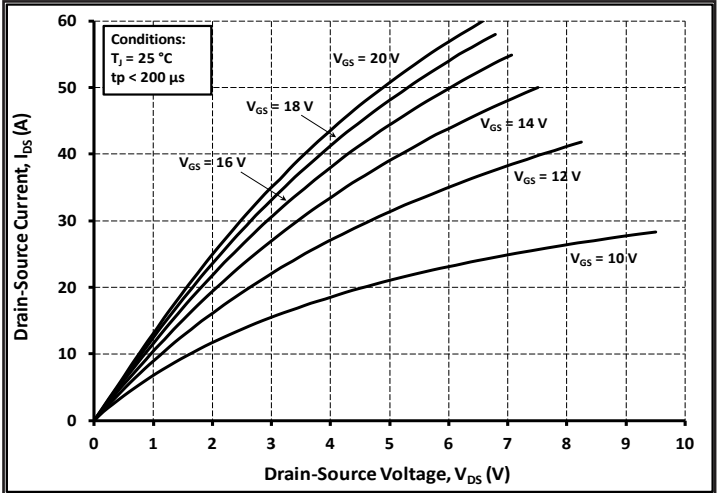

Figure 2. Output Characteristics $T_j = 25\text{ }^\circ\text{C}$

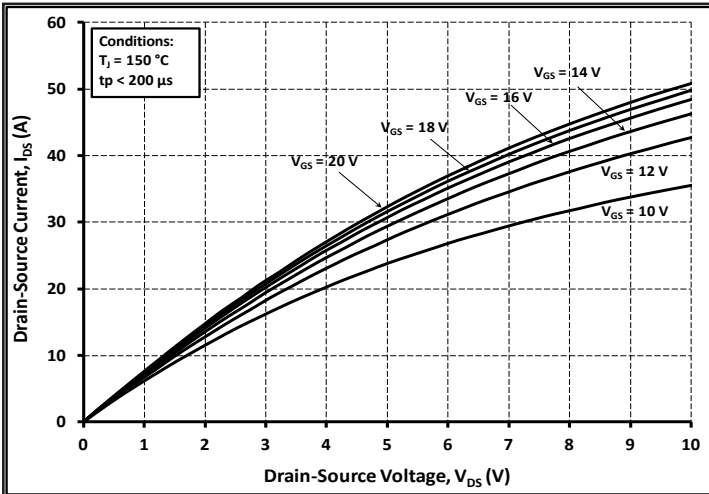

Figure 3. Output Characteristics $T_j = 150\text{ }^\circ\text{C}$

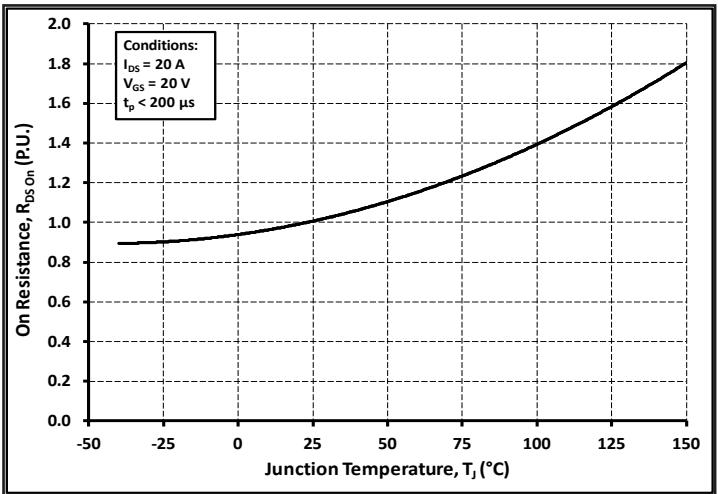

Figure 4. Normalized On-Resistance vs. Temperature

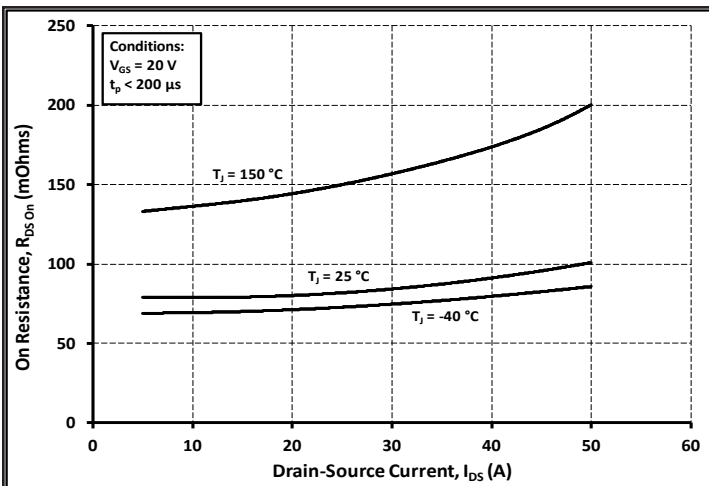

Figure 5. On-Resistance vs. Drain Current For Various Temperatures

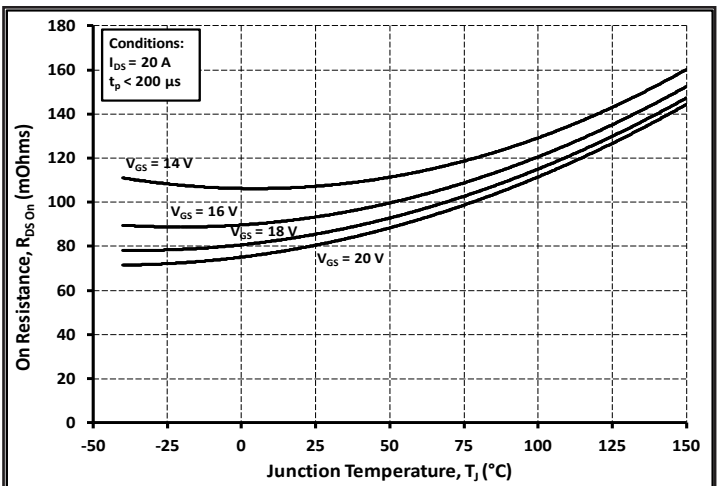

Figure 6. On-Resistance vs. Temperature for Various Various Gate-Source Voltages

Typical Performance

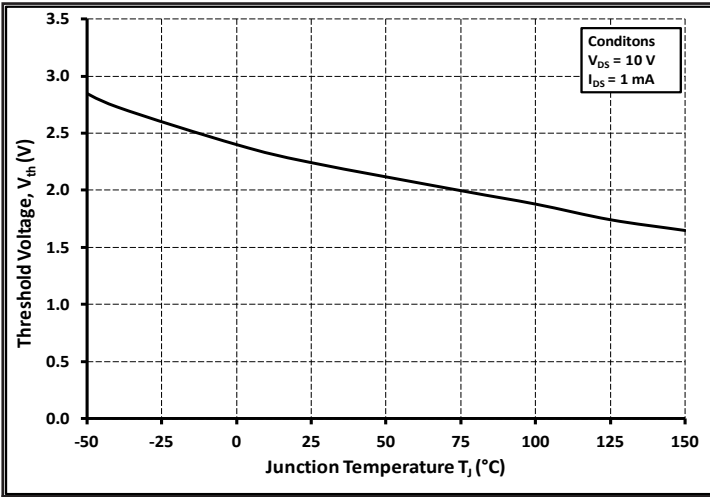

Figure 7. Threshold Voltage vs. Temperature

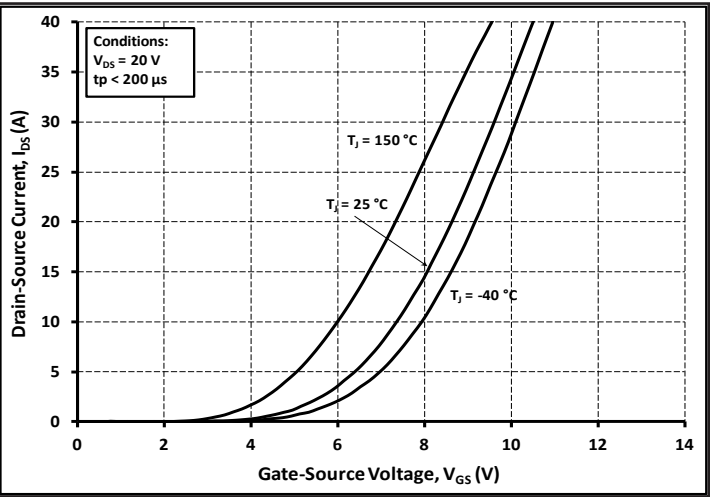

Figure 8. Transfer Characteristic for Various Junction Temperatures

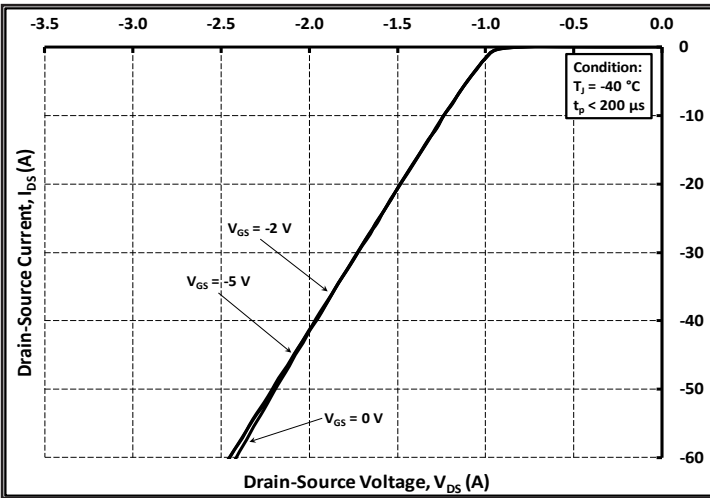

Figure 9. Diode Characteristic at -40 °C

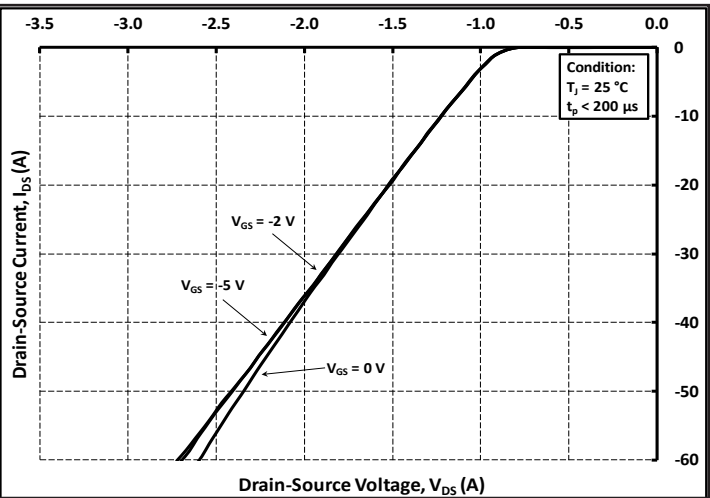

Figure 10. Diode Characteristic at 25 °C

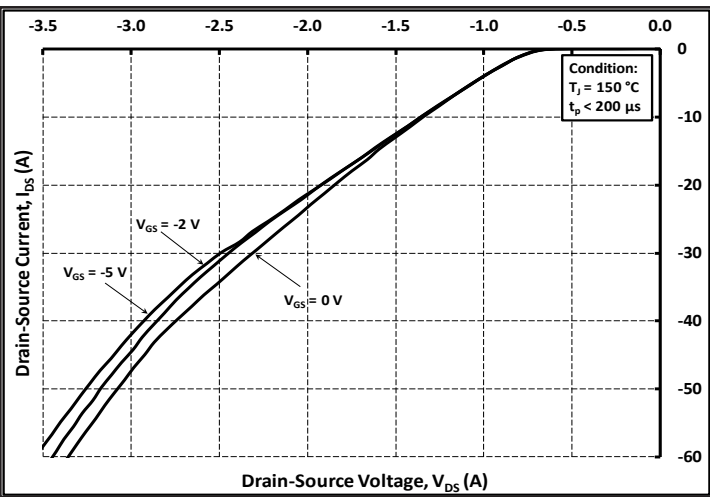

Figure 11. Diode Characteristic at 150 °C

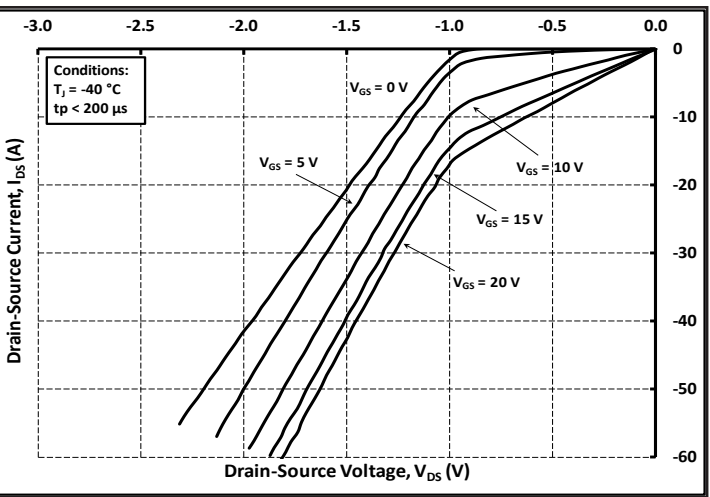

Figure 12. 3rd Quadrant Characteristic at -40 °C

Typical Performance

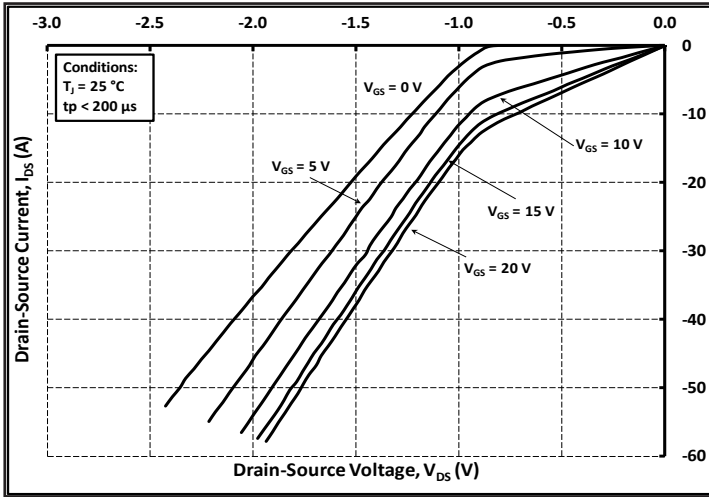

Figure 13. 3rd Quadrant Characteristic at 25 °C

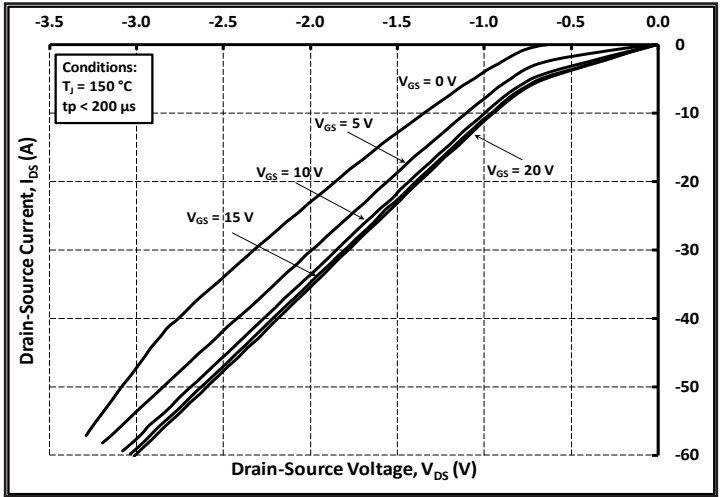

Figure 14. 3rd Quadrant Characteristic at 150 °C

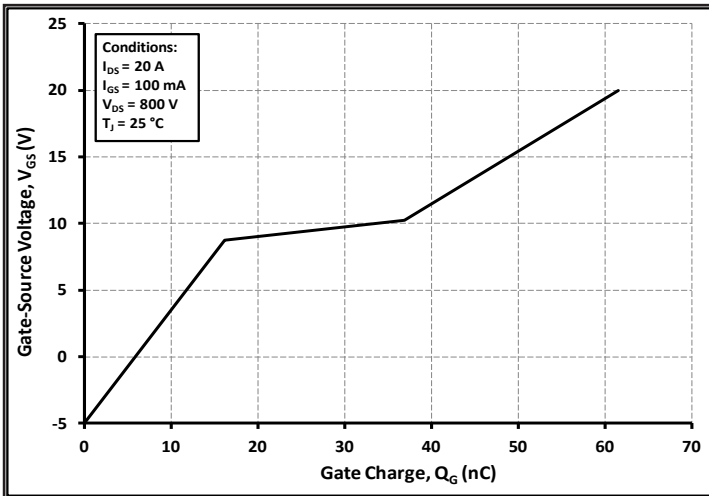

Figure 15. Gate Charge Characteristics

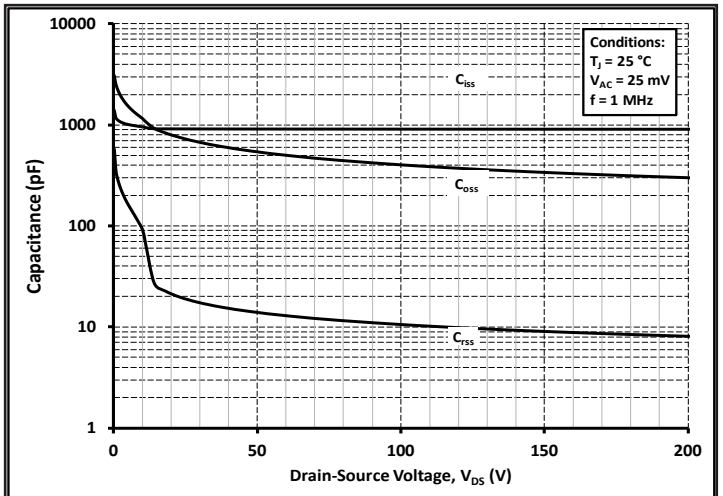

Figure 16. Capacitances vs. Drain-Source Voltage (0 - 200 V)

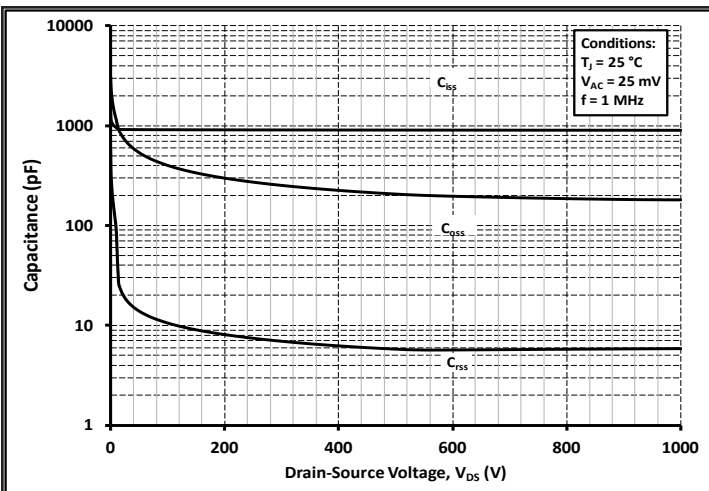

Figure 17. Capacitances vs. Drain-Source Voltage (0 - 1 kV)

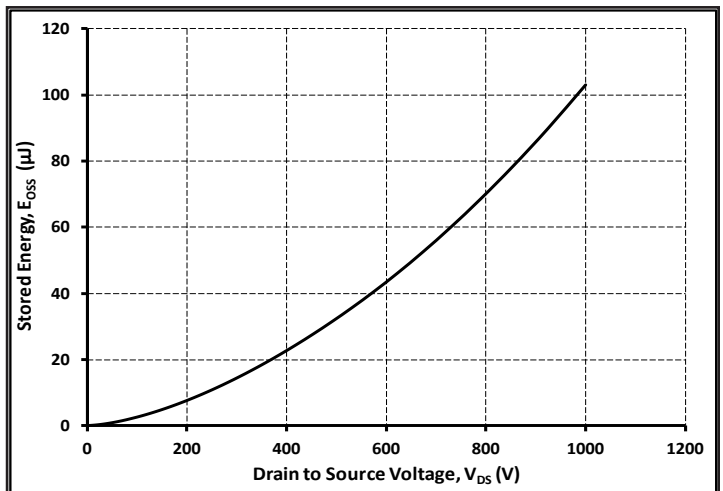

Figure 18. Output Capacitor Stored Energy

Typical Performance

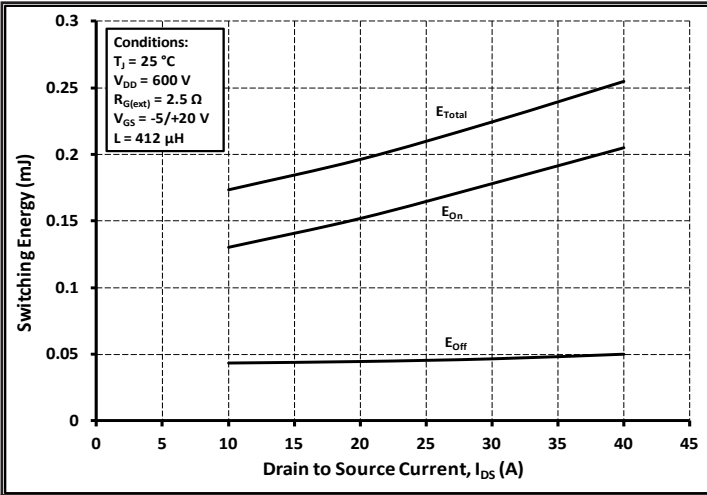

Figure 19. Inductive Switching Energy vs. Drain Current For $V_{DS} = 600\text{V}$

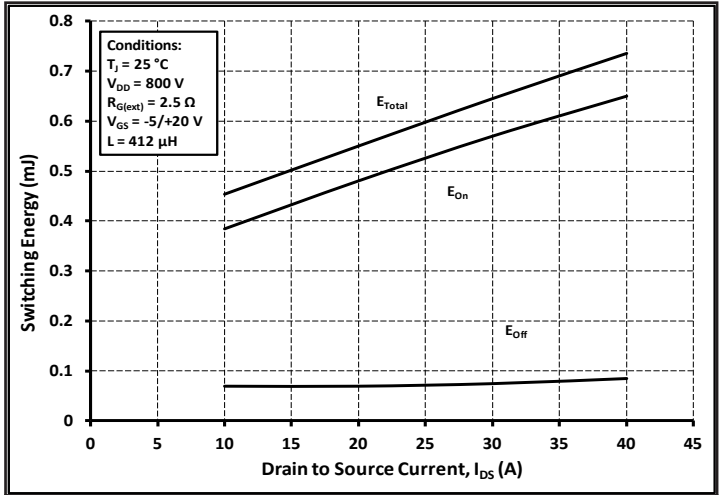

Figure 20. Inductive Switching Energy vs. Drain Current For $V_{DS} = 800\text{V}$

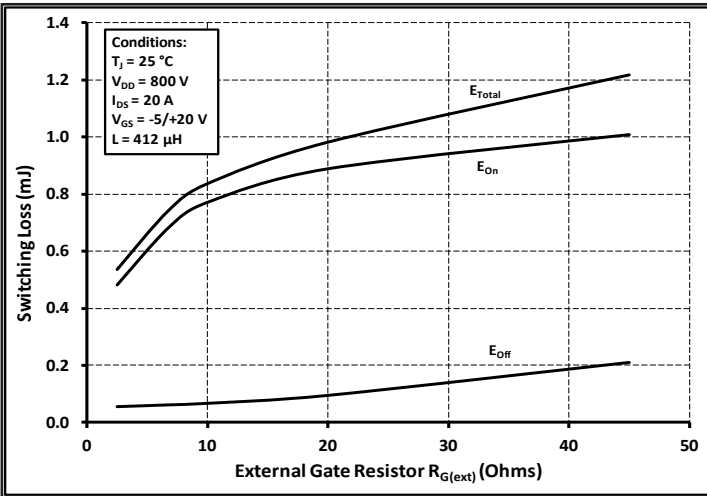

Figure 21. Inductive Switching Energy vs. $R_{G(ext)}$

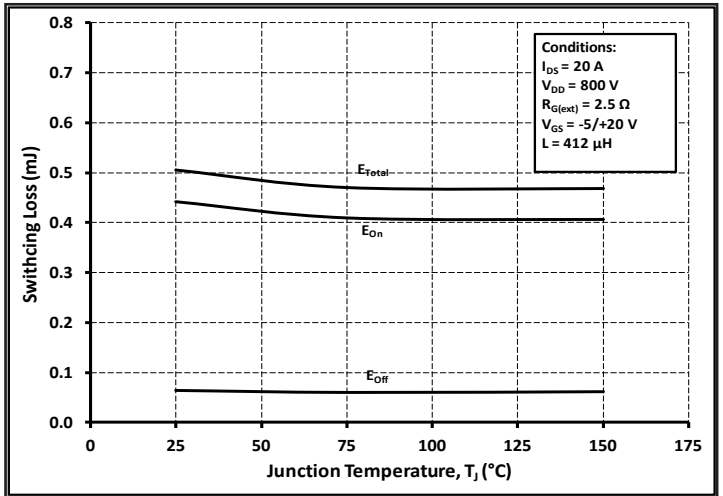

Figure 22. Inductive Switching Energy vs. Temperature

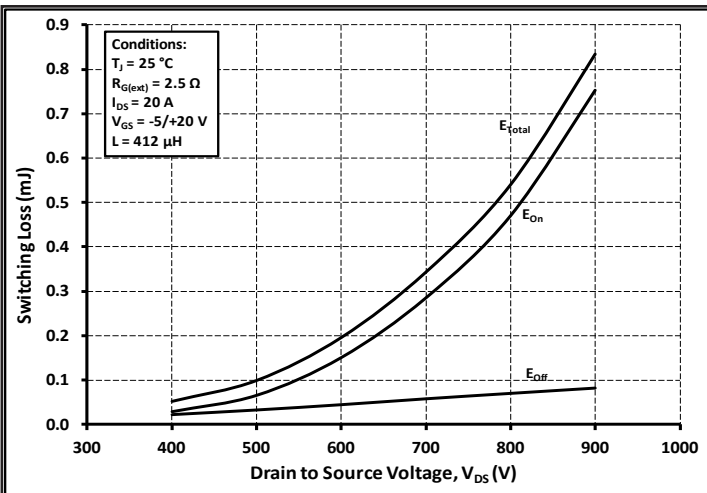

Figure 23. Inductive Switching Energy vs. V_{DS}

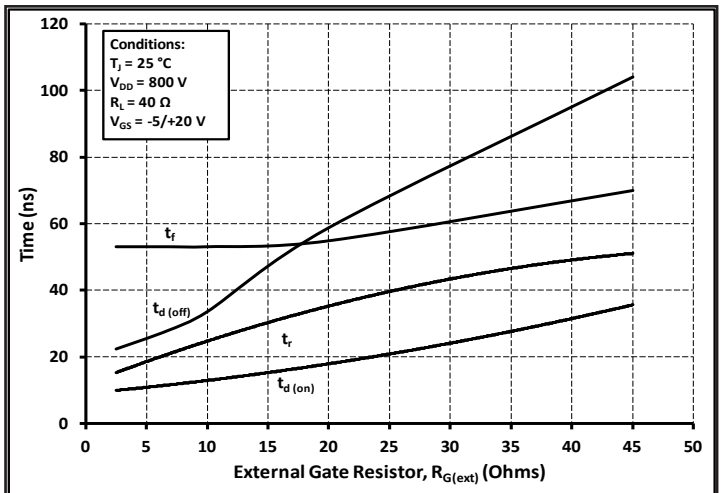

Figure 24. Timing vs. $R_{G(ext)}$

Typical Performance

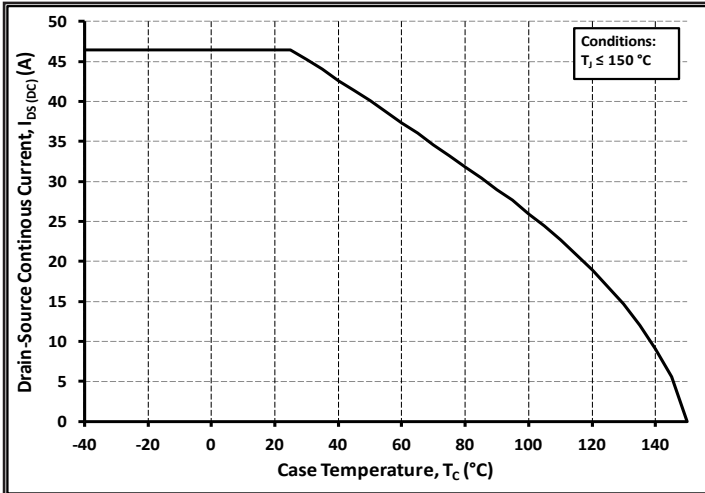

Figure 25. Continuous Drain Current Derating vs. Case Temperature

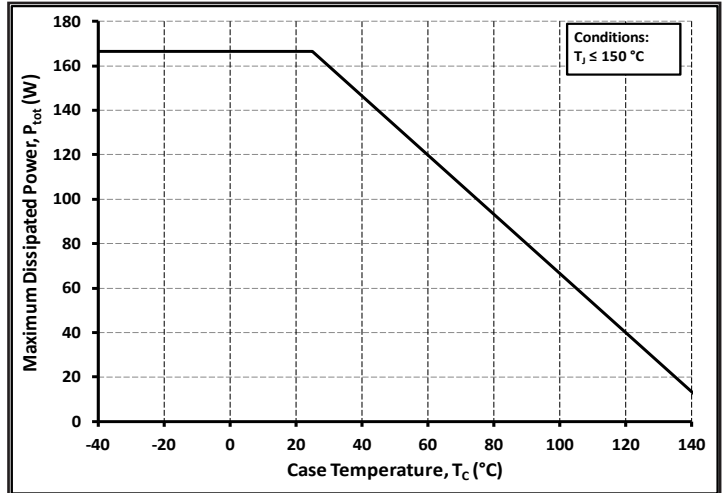

Figure 26. Maximum Power Dissipation (MOSFET) Derating vs Case Temperature

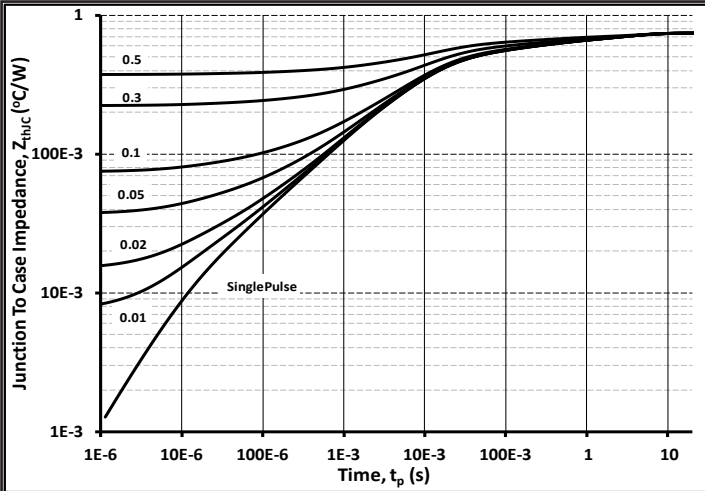

Figure 27. MOSFET Junction to Case Thermal Impedance

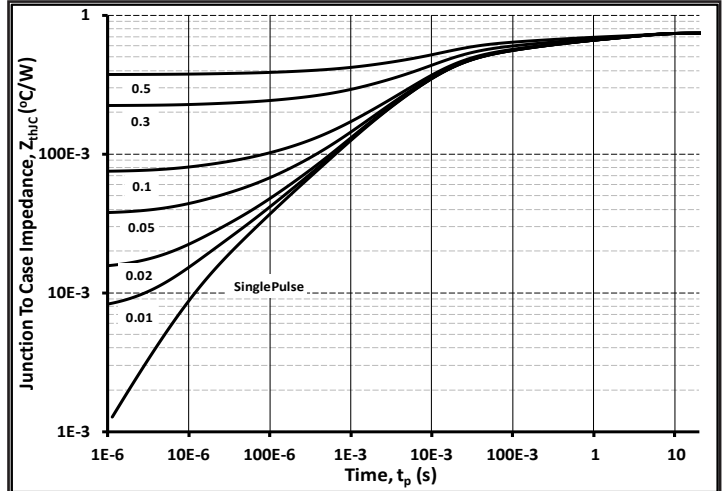

Figure 28. Diode Junction to Case Thermal Impedance

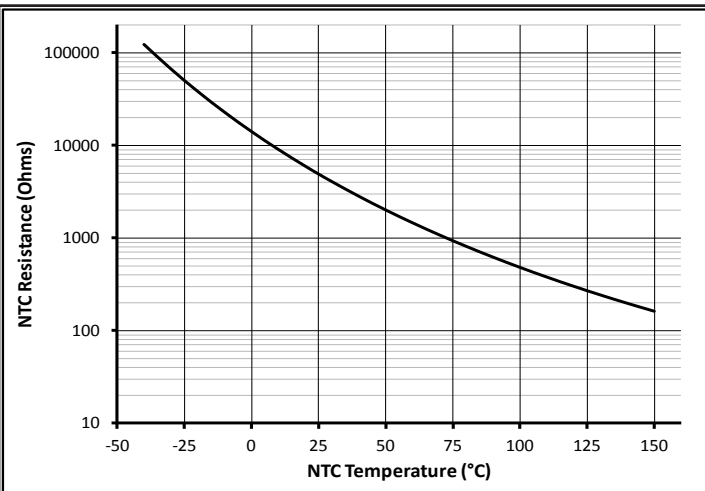

Figure 29. NTC Resistance vs NTC Temperature

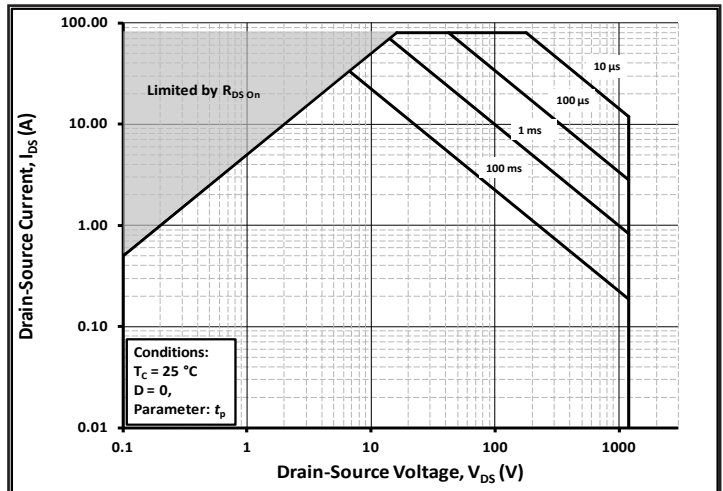

Figure 30. MOSFET Safe Operating Area

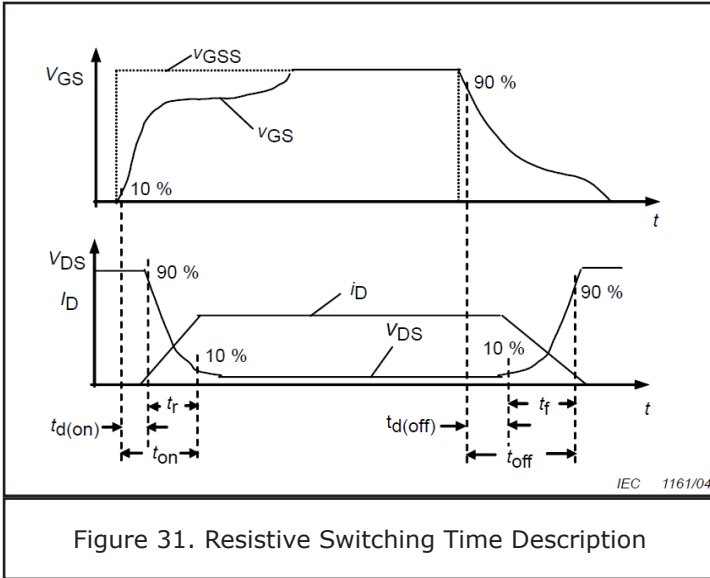
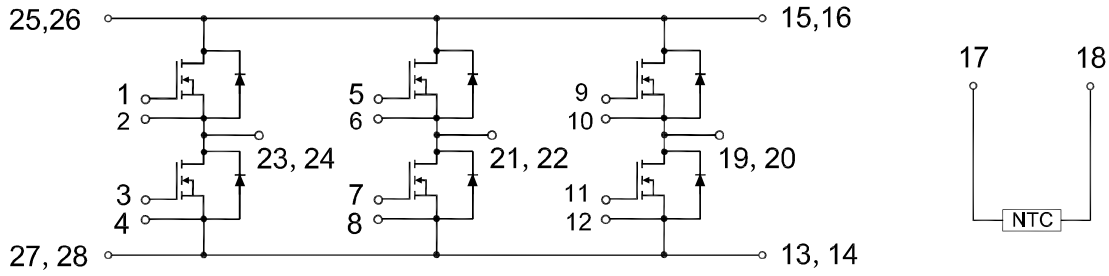

Figure 31. Resistive Switching Time Description

NTC Characteristics

Symbol	Condition	Typ.	Max.	Unit
R_{25}	$T_c = 25\text{ }^\circ\text{C}$	5		$k\Omega$
Delta R/R	$T_c = 100\text{ }^\circ\text{C}, R_{100} = 481\ \Omega$		± 5	%
P_{25}	$T_c = 25\text{ }^\circ\text{C}$		20	mW
$B_{25/50}$	$R_2 = R_{25} \exp[B_{25/50}(1/T_2 - 1/(298.15K))]$	3380		K
$B_{25/80}$	$R_2 = R_{25} \exp[B_{25/80}(1/T_2 - 1/(298.15K))]$	3440		K

Schematic



Package Dimensions (mm)

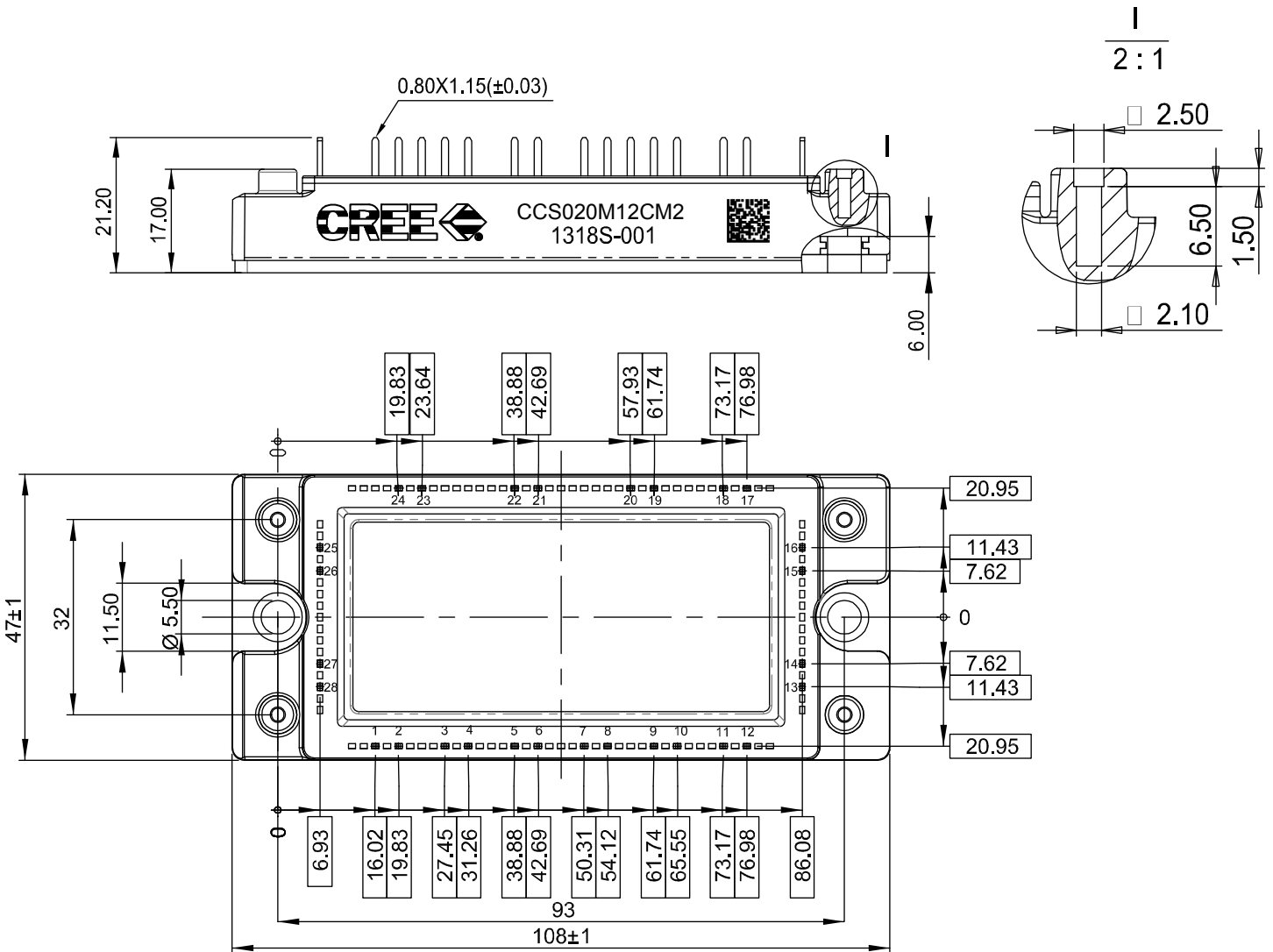



Notes

- **RoHS Compliance**

The levels of RoHS restricted materials in this product are below the maximum concentration values (also referred to as the threshold limits) permitted for such substances, or are used in an exempted application, in accordance with EU Directive 2011/65/EC (RoHS2), as implemented January 2, 2013. RoHS Declarations for this product can be obtained from your Cree representative or from the Product Documentation sections of www.cree.com.

- **REACH Compliance**

REACH substances of high concern (SVHCs) information is available for this product. Since the European Chemical Agency (ECHA) has published notice of their intent to frequently revise the SVHC listing for the foreseeable future, please contact a Cree representative to insure you get the most up-to-date REACH SVHC Declaration. REACH banned substance information (REACH Article 67) is also available upon request.

- This product has not been designed or tested for use in, and is not intended for use in, applications implanted into the human body nor in applications in which failure of the product could lead to death, personal injury or property damage, including but not limited to equipment used in the operation of nuclear facilities, life-support machines, cardiac defibrillators or similar emergency medical equipment, aircraft navigation or communication or control systems, air traffic control systems.

Module Application Note:

The SiC MOSFET module switches at speeds beyond what is customarily associated with IGBT based modules. Therefore, special precautions are required to realize the best performance. The interconnection between the gate driver and module housing needs to be as short as possible. This will afford the best switching time and avoid the potential for device oscillation. Also, great care is required to insure minimum inductance between the module and link capacitors to avoid excessive V_{DS} overshoots.

Please Refer to application note: Design Considerations when using Cree SiC Modules Part 1 and Part 2. [CPWR-AN12, CPWR-AN13]



Компания «ЭлектроПласт» предлагает заключение долгосрочных отношений при поставках импортных электронных компонентов на взаимовыгодных условиях!

Наши преимущества:

- Оперативные поставки широкого спектра электронных компонентов отечественного и импортного производства напрямую от производителей и с крупнейших мировых складов;
- Поставка более 17-ти миллионов наименований электронных компонентов;
- Поставка сложных, дефицитных, либо снятых с производства позиций;
- Оперативные сроки поставки под заказ (от 5 рабочих дней);
- Экспресс доставка в любую точку России;
- Техническая поддержка проекта, помощь в подборе аналогов, поставка прототипов;
- Система менеджмента качества сертифицирована по Международному стандарту ISO 9001;
- Лицензия ФСБ на осуществление работ с использованием сведений, составляющих государственную тайну;
- Поставка специализированных компонентов (Xilinx, Altera, Analog Devices, Intersil, Interpoint, Microsemi, Aeroflex, Peregrine, Syfer, Eurofarad, Texas Instrument, Miteq, Cobham, E2V, MA-COM, Hittite, Mini-Circuits, General Dynamics и др.);

Помимо этого, одним из направлений компании «ЭлектроПласт» является направление «Источники питания». Мы предлагаем Вам помощь Конструкторского отдела:

- Подбор оптимального решения, техническое обоснование при выборе компонента;
- Подбор аналогов;
- Консультации по применению компонента;
- Поставка образцов и прототипов;
- Техническая поддержка проекта;
- Защита от снятия компонента с производства.



Как с нами связаться

Телефон: 8 (812) 309 58 32 (многоканальный)

Факс: 8 (812) 320-02-42

Электронная почта: org@eplast1.ru

Адрес: 198099, г. Санкт-Петербург, ул. Калинина, дом 2, корпус 4, литера А.