

600mA* Step-down DC/DC Converter with Synchronous Rectifier

NO.EA-155-111124

OUTLINE

The RP500x Series are CMOS-based 600mA* step-down DC/DC Converters with synchronous rectifier.

Each of these ICs consists of an oscillator, a switching control circuit, a reference voltage unit, an error amplifier, a soft-start circuit, protection circuits, UVLO circuit, switching transistors, and so on. A low ripple, high efficiency step-down DC/DC converter can be easily composed of this IC with only an inductor and capacitors.

In terms of the output voltage, since the feedback resistances are built-in, the voltage is fixed internally. 0.1V step output can be set by laser-trim and 1.5% or 24mV tolerance depending on the output voltage is guaranteed. Mode alternative circuit works automatically for improving the efficiency. Considering fixed noise frequency, PWM fixed control type is also available.

As protection circuits, the current limit circuit which limits peak current of Lx at each clock cycle, and the latch type protection circuit which works if the term of the over-current condition keeps on a certain time exist. The latch-type protection circuit works to latch an internal driver with keeping it disable. To release the condition of the protection, after disabling this IC with a chip enable circuit, enable it again, or restart this IC with power-on or make the supply voltage at UVLO detector threshold level or lower than UVLO.

Since packages are WLCSP-6-P2, DFN1616-6, DFN(PLP)1820-6, SOT-23-6W, high density mounting on boards is possible.

*)This is an approximate value, because output current depends on conditions and external parts.

FEATURES

- Supply Current Typ. 400 μ A (at PWM mode)
Typ. 100 μ A (at VFM mode)
- Standby Current Max. 5 μ A
- Input Voltage Range 2.55V to 5.50V
- Output Voltage Range 1.1V to 3.3V (0.1V steps)
(For other voltages, please refer to MARK INFORMATIONS.)
- Output Voltage Accuracy $\pm 1.5\%$ ($V_{OUT} \geq 1.6V$), $\pm 24mV$ ($V_{OUT} < 1.6V$)
- Temperature-Drift Coefficient of Output Voltage ... Typ. $\pm 100ppm/^{\circ}C$
- Oscillator Frequency Typ. 1.2MHz
- Oscillator Maximum Duty Cycle Min. 100%
- Built-in Driver ON Resistance Typ. Pch. 0.3 Ω , Nch. 0.38 Ω ($V_{IN} = 3.6V$)
- UVLO Detector Threshold Typ. 2.2V
- Soft Start Time Typ. 120 μ s
- Lx Current Limit Typ. 900mA
- Latch type Protection Circuit Typ. 1.5ms
- Two choices of Switching Mode Automatic PWM/VFM mode change / PWM fixed
- Packages WLCSP-6-P2, DFN1616-6, DFN(PLP)1820-6, SOT-23-6W

APPLICATIONS

- Power source for battery-powered equipment.
- Power source for hand-held communication equipment, cameras, VCRs, camcorders.
- Power source for HDD, portable equipment.

RP500x

BLOCK DIAGRAMS

RP500xxx1A/2A



*) only RP500xxx1A for automatic PWM/VFM mode change

RP500xxx3A/4A



*) only RP500xxx3A for automatic PWM/VFM mode change

* RP500Z (WLCSP-6-P2) is the non-promotion product. As of March in 2014.

RP500x

SELECTION GUIDE

The output voltage, switching mode, and auto discharge function for the ICs can be selected at the user's request.

Product Name	Package	Quantity per Reel	Pb Free	Halogen Free
RP500Zxx*A-E2-F	WLCSP-6-P2	5,000 pcs	Yes	Yes
RP500Lxx*A-TR	DFN1616-6	5,000 pcs	Yes	Yes
RP500Kxx*A-TR	DFN(PLP)1820-6	5,000 pcs	Yes	Yes
RP500Nxx*A-TR-FE	SOT-23-6W	3,000 pcs	Yes	Yes

xx: The output voltage can be designated in the range from 1.1V(11) to 3.3V(33) in 0.1V steps^{*1}.
(For other voltages, please refer to MARK INFORMATIONS.)

* : The switching mode, and auto discharge function can be designated.

Code	Modulation method	Auto discharge function
1	PWM/VFM auto switching	No
2	PWM fixed	No
3	PWM/VFM auto switching	Yes
4	PWM fixed	Yes

(The RP500Kxx3A does not exist. Please use RP500Lxx3A.)

*1) 0.05V step is also available as a custom code.

PIN CONFIGURATIONS



PIN DESCRIPTIONS

• WLCSP-6-P2, SOT-23-6W

Pin No	Symbol	Pin Description
1	V_{OUT}	Output Pin
2	PGND	Ground Pin
3	Lx	Lx Switching Pin
4	V_{IN}	Input Pin
5	AGND	Ground Pin
6	CE	Chip Enable Pin ("H" Active)

• DFN1616-6, DFN(PLP)1820-6

Pin No	Symbol	Pin Description
1	CE	Chip Enable Pin ("H" Active)
2	AGND	Ground Pin
3	V_{IN}	Input Pin
4	Lx	Lx Switching Pin
5	PGND	Ground Pin
6	V_{OUT}	Output Pin

*) Tab is GND level. (They are connected to the reverse side of this IC.)
 The tab is better to be connected to the GND, but leaving it open is also acceptable.

* RP500Z (WLCSP-6-P2) is the non-promotion product. As of March in 2014.

RP500x

ABSOLUTE MAXIMUM RATINGS

AGND=PGND=0V

Symbol	Item	Rating	Unit
V_{IN}	Input Voltage	-0.3 to 6.5	V
V_{Lx}	Lx pin Voltage	-0.3 to $V_{IN}+0.3$	V
V_{CE}	CE Pin Input Voltage	-0.3 to 6.5	V
V_{OUT}	Output Voltage	-0.3 to 6.5	V
I_{Lx}	Lx Pin Output Current	800	mA
P_D	Power Dissipation (WLCSP-6-P2) *	650	mW
	Power Dissipation (DFN1616-6) *	640	
	Power Dissipation (DFN(PLP)1820-6) *	880	
	Power Dissipation (SOT-23-6W) *	430	
T_{opt}	Operating Temperature Range	-40 to 85	°C
T_{stg}	Storage Temperature Range	-55 to 125	°C

*) For Power Dissipation, please refer to PACKAGE INFORMATION.

ABSOLUTE MAXIMUM RATINGS

Electronic and mechanical stress momentarily exceeded absolute maximum ratings may cause the permanent damages and may degrade the life time and safety for both device and system using the device in the field. The functional operation at or over these absolute maximum ratings is not assured.

RP500x

ELECTRICAL CHARACTERISTICS

• RP500x

T_{opt}=25°C

Symbol	Item	Conditions	Min.	Typ.	Max.	Unit	
V _{IN}	Operating Input Voltage		2.55		5.5	V	
V _{OUT}	Output Voltage	V _{IN} =V _{CE} =3.6V or Set V _{OUT} +1V	V _{OUT} ≥ 1.6V	×0.985	×1.015	V	
			V _{OUT} < 1.6V	-24	24	mV	
ΔV _{OUT} /ΔT _{opt}	Output Voltage Temperature Coefficient	-40°C ≤ T _{opt} ≤ 85°C		±100		ppm /°C	
f _{osc}	Oscillator Frequency	V _{IN} =V _{CE} =3.6V or Set V _{OUT} +1V	0.96	1.2	1.44	MHz	
I _{DD1}	Supply Current 1	V _{IN} =V _{CE} =5.5V, V _{OUT} =0V		400	500	μA	
I _{DD2}	Supply Current 2	V _{IN} =V _{CE} =V _{OUT} =5.5V	PWM/VFM		100	160	μA
			PWM fixed		400	500	
I _{standby}	Standby Current	V _{IN} =5.5V, V _{CE} =0V		0	5	μA	
R _{ONP}	ON Resistance of Pch Tr.	V _{IN} =3.6V, I _{LX} =-100mA		0.3		Ω	
R _{ONN}	ON Resistance of Nch Tr.	V _{IN} =3.6V, I _{LX} =-100mA		0.38		Ω	
I _{LXleakH}	Lx Leakage Current "H"	V _{IN} =V _{LX} =5.5V, V _{CE} =0V	-1	0	5	μA	
I _{LXleakL}	Lx Leakage Current "L"	V _{IN} =5.5V, V _{CE} =V _{LX} =0V	-5	0	1	μA	
I _{VOUTH}	V _{OUT} "H" Input Current *1	V _{IN} =V _{OUT} =5.5V, V _{CE} =0V	-1	0	1	μA	
I _{VOUTL}	V _{OUT} "L" Input Current	V _{IN} =5.5V, V _{CE} =V _{OUT} =0V	-1	0	1	μA	
I _{CEH}	CE "H" Input Current	V _{IN} =V _{CE} =5.5V	-1	0	1	μA	
I _{CEL}	CE "L" Input Current	V _{IN} =5.5V, V _{CE} =0V	-1	0	1	μA	
V _{CEH}	CE Input Voltage "H"	V _{IN} =5.5V	1.0			V	
V _{CEL}	CE Input Voltage "L"	V _{IN} =5.5V			0.4	V	
Maxduty	Oscillator Maximum Duty Cycle		100			%	
t _{start}	Soft-start Time	V _{IN} =V _{CE} =3.6V or Set V _{OUT} +1V		120	150	μs	
I _{LXlim}	Lx Current Limit	V _{IN} =V _{CE} =3.6V or Set V _{OUT} +1V	600	900		mA	
t _{prot}	Protection Delay Time	V _{IN} =V _{CE} =3.6V or Set V _{OUT} +1V	0.5	1.5	5.0	ms	
V _{UVLO1}	UVLO Detector Threshold	V _{IN} =V _{CE}	2.1	2.2	2.3	V	
V _{UVLO2}	UVLO Released Voltage	V _{IN} =V _{CE}	2.2	2.3	2.4	V	
R _{LOW}	Low Output Nch Tr. ON Resistance *2	V _{IN} =3.6V, V _{CE} =0V		80		Ω	

Test circuit is "OPEN LOOP" and AGND=PGND=0V unless otherwise noted.

*1) without auto discharge version only

*2) with auto discharge version only

RECOMMENDED OPERATING CONDITIONS (ELECTRICAL CHARACTERISTICS)

All of electronic equipment should be designed that the mounted semiconductor devices operate within the recommended operating conditions. The semiconductor devices cannot operate normally over the recommended operating conditions, even if when they are used over such conditions by momentary electronic noise or surge. And the semiconductor devices may receive serious damage when they continue to operate over the recommended operating conditions.

TEST CIRCUITS



Output Voltage



Oscillator Frequency



Supply Current 1,2



Standby Current



CE "H"/"L" Input Current



VOUT "H"/"L" Current

* RP500Z (WLCSP-6-P2) is the non-promotion product. As of March in 2014.

RP500x



Lx Leakage Current



CE Input Voltage



**Pch • Nch transistor ON resistance /
Output Delay for Protection / Lx Current limit**



Soft-start Time



UVLO Detector Threshold • Released Voltage

TYPICAL APPLICATION



Symbol	Parts Recommendation		
C _{IN}	10µF	Ceramic	C2012JB0J106K (TDK)
C _{OUT}	10µF	Ceramic	C2012JB0J106K (TDK)
L	4.7µH	VLF3010AT-4R7MR30	

TECHNICAL NOTES

When using these ICs, consider the following points:

- Set the same level as AGND and PGND.
- Set external components such as an inductor, C_{IN}, C_{OUT} as close as possible to the IC, in particular, minimize the wiring to V_{IN} pin and PGND pin. Reinforce the V_{IN}, PGND, and V_{OUT} lines sufficiently. Large switching current may flow in these lines. If the impedance of V_{IN} and PGND lines is too large, the internal voltage level in this IC may shift caused by the switching current, and the operation might be unstable. The wiring between V_{OUT} and load and between L and V_{OUT} should be separated.
- Use an external capacitor C_{IN} between V_{IN} and GND, and C_{OUT} with a capacity of 10µF or more ceramic type.
- Choose an inductor with inductance range from 4.7µH to 10µH. The phase compensation has been made by these values with output capacitors. The recommendation characteristics of the inductor are low DC resistance, large enough permissible current, and strong against the magnetic saturation. Inductance value may shift depending on an inductor. If the inductance value at an actual load current is low, L_x peak current may increase and may overlap the L_x current limit. As a result, over current protection may work.
- Over current protection circuit may be affected by self-heating and heat radiation environment.

*The performance of power source circuits using these ICs extremely depends upon the peripheral circuits. Pay attention in the selection of the peripheral circuits. In particular, design the peripheral circuits in a way that the values such as voltage, current, and power of each component, PCB patterns and the IC do not exceed their respected rated values. (such as the voltage, current, and power)

RP500x

Operation of step-down DC/DC converter and Output Current

The DC/DC converter charges energy in the inductor when Lx transistor is ON, and discharges the energy from the inductor when Lx transistor is OFF and controls with less energy loss, so that a lower output voltage than the input voltage is obtained. The operation will be explained with reference to the following diagrams:



- Step 1: Pch Tr. turns on and current $I_L (=i_1)$ flows, and energy is charged into CL. At this moment, I_L increases from $I_{Lmin} (=0)$ to reach I_{Lmax} in proportion to the on-time period (t_{on}) of Pch Tr.
- Step 2: When Pch Tr. turns off, Synchronous rectifier Nch Tr. turns on in order that L maintains I_L at I_{Lmax} , and current $I_L (=i_2)$ flows.
- Step 3: $I_L (=i_2)$ decreases gradually and reaches $I_L = I_{Lmin} = 0$ after a time period of t_{open} , and Nch Tr. turns off. Provided that in the continuous mode, next cycle starts before I_L becomes to 0 because t_{off} time is not enough. In this case, I_L value increases from this $I_{Lmin} (>0)$.

In the case of PWM control system, the output voltage is maintained by controlling the on-time period (t_{on}), with the oscillator frequency (f_{osc}) being maintained constant.

The maximum value (I_{Lmax}) and the minimum value (I_{Lmin}) of the current flowing through the inductor are the same as those when Pch Tr. turns on and off.

The difference between I_{Lmax} and I_{Lmin} , which is represented by ΔI :

$$\Delta I = I_{Lmax} - I_{Lmin} = V_{OUT} \times t_{open} / L = (V_{IN} - V_{OUT}) \times t_{on} / L \dots\dots\dots \text{Equation 1}$$

wherein,

$$T = 1 / f_{osc} = t_{on} + t_{off}$$

$$\text{duty (\%)} = t_{on} / T \times 100 = t_{on} \times f_{osc} \times 100$$

$$t_{open} \leq t_{off}$$

In Equation 1, $V_{OUT} \times t_{open} / L$ and $(V_{IN} - V_{OUT}) \times t_{on} / L$ respectively show the change of the current at "ON", and the change of the current at "OFF".

Discontinuous mode and Continuous mode

When the output current (I_{OUT}) is relatively small, $t_{open} < t_{off}$ as illustrated in the following diagram. In this case, the energy is charged in the inductor during the time period of t_{on} and is discharged in its entirety during the time period of t_{off} , therefore I_{Lmin} becomes to zero ($I_{Lmin}=0$). When I_{OUT} is gradually increased, eventually, t_{open} becomes to t_{off} ($t_{open}=t_{off}$), and when I_{OUT} is further increased, I_{Lmin} becomes larger than zero ($I_{Lmin}>0$). The former mode is referred to as the discontinuous mode and the latter mode is referred to as continuous mode.

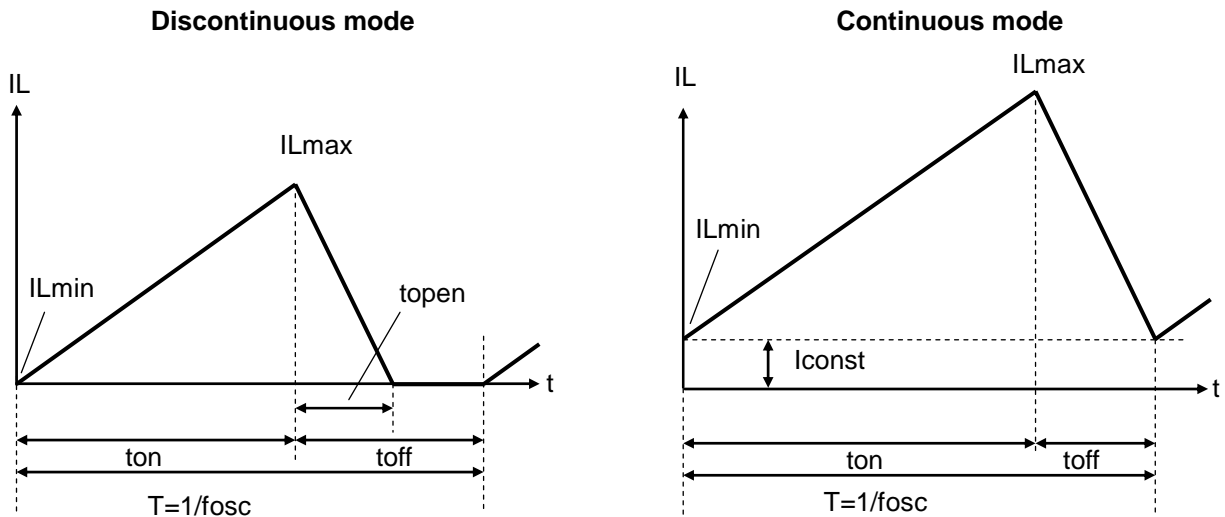

In the continuous mode, when Equation 1 is solved for t_{on} and assumed that the solution is t_{onc} ,

$$t_{onc} = T \times V_{OUT} / V_{IN} \dots\dots\dots \text{Equation 2}$$

When $t_{on} < t_{onc}$, the mode is the discontinuous mode, and when $t_{on} = t_{onc}$, the mode is the continuous mode.

Output Current and selection of External components

The relation between the output current and external components is as follows:

When Pch Tr. of L_x is ON:

(Wherein, Ripple Current p-p value is described as I_{RP} , ON resistance of Pch Tr. and Nch Tr. of L_x are respectively described as R_{ONP} and R_{ONN} , and the DC resistor of the inductor is described as R_L .)

$$V_{IN} = V_{OUT} + (R_{ONP} + R_L) \times I_{OUT} + L \times I_{RP} / t_{on} \dots\dots\dots \text{Equation 3}$$

When Pch Tr. of L_x is "OFF" (Nch Tr. is "ON"):

$$L \times I_{RP} / t_{off} = R_{ONN} \times I_{OUT} + V_{OUT} + R_L \times I_{OUT} \dots\dots\dots \text{Equation 4}$$

Put Equation 4 to Equation 3 and solve for ON duty of Pch transistor, $D_{ON} = t_{on} / (t_{off} + t_{on})$,

$$D_{ON} = (V_{OUT} + R_{ONN} \times I_{OUT} + R_L \times I_{OUT}) / (V_{IN} + R_{ONN} \times I_{OUT} - R_{ONP} \times I_{OUT}) \dots\dots\dots \text{Equation 5}$$

* RP500Z (WLCSP-6-P2) is the non-promotion product. As of March in 2014.

RP500x

Ripple Current is as follows:

$$I_{RP} = (V_{IN} - V_{OUT} - R_{ONP} \times I_{OUT} - R_L \times I_{OUT}) \times D_{ON} / f_{osc} / L \dots \dots \dots \text{Equation 6}$$

wherein, peak current that flows through L, and Lx Tr. is as follows:

$$I_{Lx\max} = I_{OUT} + I_{RP} / 2 \dots \dots \dots \text{Equation 7}$$

Consider $I_{Lx\max}$, condition of input and output and select external components.

*The above explanation is directed to the calculation in an ideal case in continuous mode.

TIMING CHART

(1) Soft Start Time

- In the case of starting this IC with CE

In the case of starting this IC with CE, the operation can be as in the timing chart below.

When the voltage of CE pin (V_{CE}) is beyond the threshold level, the operation of the IC starts. The threshold voltage of CE pin is in between CE "H" input voltage (V_{CEH}) and CE "L" input voltage (V_{CEL}) described in the electrical characteristics table. Soft-start circuit operates, and after the certain time, the reference voltage inside the IC (V_{REF}) is rising gradually up to the constant value.

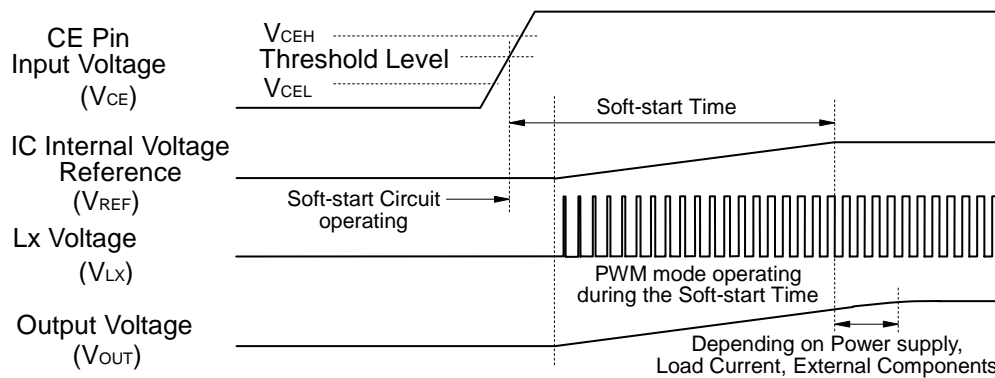

Soft-start time is the time interval from soft start circuit starting point to the reference voltage level reaching point up to this constant level.

*Soft start time is not always equal to the turn-on speed of DC/DC converter.

The power supply capacity for this IC, load current, inductance and capacitance values affect the turn-on speed.

- In the case of starting with power supply

In the case of starting with power supply, when the input voltage (V_{IN}) is larger than UVLO released voltage (V_{UVLO2}), soft start circuit operates, and after that, the same explanation above is applied to the operation.

Soft-start time is the time interval from soft start circuit starting point to the reference voltage level reaching point up to this constant level.



*Turn-on speed is affected by next conditions;

- Input Voltage (V_{IN}) rising speed depending on the power supplier to the IC and input capacitor C_{IN} .
- Output Capacitor C_{OUT} value and load current value.

RP500x

(2) Under Voltage Lockout (UVLO) Circuit

The step-down DC/DC converter stops and ON duty becomes 100%, if input voltage (V_{IN}) becomes less than the set output voltage (Set V_{OUT}), the output voltage (V_{OUT}) gradually drops according to the input voltage (V_{IN}). If the input voltage drops more and becomes less than UVLO detector threshold (V_{UVLO1}), the under voltage lockout circuit (UVLO) operates, the IC internal reference voltage (V_{REF}) stops, switching transistors turn off and the output voltage drops according to the load and output capacitor C_{OUT} value. To restart the normal operation, the input voltage (V_{IN}) must be more than the UVLO released voltage (V_{UVLO2}).

The timing chart below describes the operation with varying the input voltage (V_{IN}).

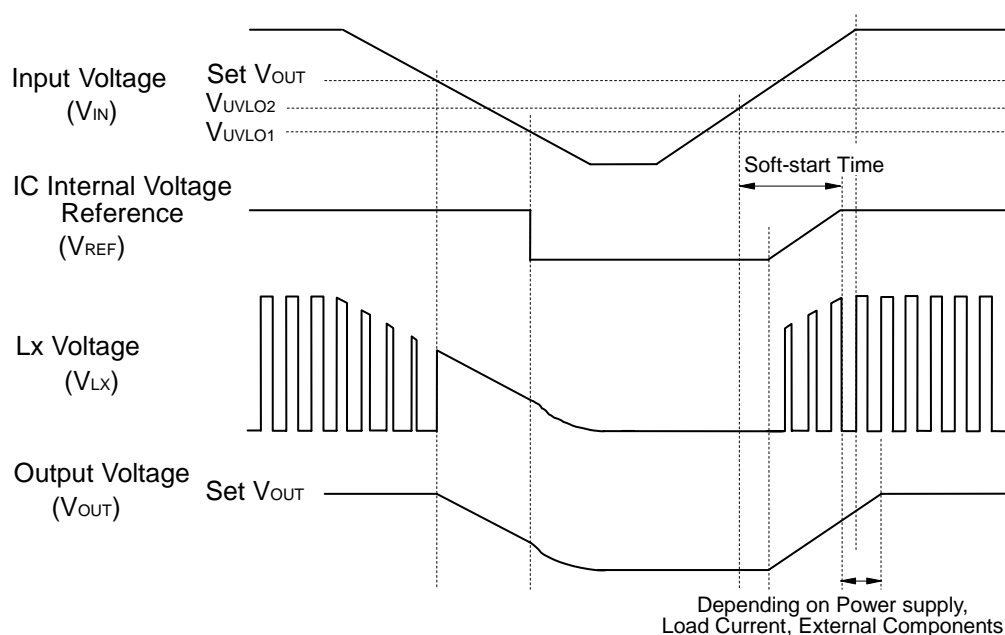

*Actually, the waveform of V_{OUT} at UVLO working and releasing varies depending on the initial voltage of C_{OUT} and load current situation.

(3) Over Current Protection Circuit, Latch Type Protection Circuit

Over current protection circuit supervises the coil peak current (the current flowing Pch transistor) at each switching cycle, and if the current beyond the Lx current limit (I_{Lxlim}), Pch transistor is turned off. the Lx current limit of RP500x is Typ.900mA.

Further, if the over current status continues equal or longer than protection delay time, or, when the Lx limit current is exceeded even once when the driver operates by duty 100%, a built-in driver is latched in the OFF state and the operation of DC/DC converter stops.

*Lx current limit and protection delay time is affected by self-heating and ambient environment. If the output is short and the input voltage (V_{IN}) is drastically dropped or becomes unstable, the protection operation and delay time may vary.



To release the condition of latch type protection, restart this IC by inputting "L" signal to CE pin, or restart this IC with power-on or make the supply voltage lower than UVLO detector threshold (V_{UVLO1}) level.

The timing chart shown below describes the changing process of input voltage rising, stable operating, operating with large current, reset with CE pin, stable operating, input voltage falling, input voltage recovering, and stable operating.

If too large current flows through the circuit because of short or other reasons, after the delay time of latch type protection a built-in driver is latched in the OFF state and V_{Lx} signal will be "L", then output will turn off. At the point (1), release the latch type protection is realized with CE reset as changed CE signal from "L" to "H".

At the point (2), release the latch type protection is realized with UVLO reset as make the supply voltage lower than UVLO detector threshold (V_{UVLO1}) level.

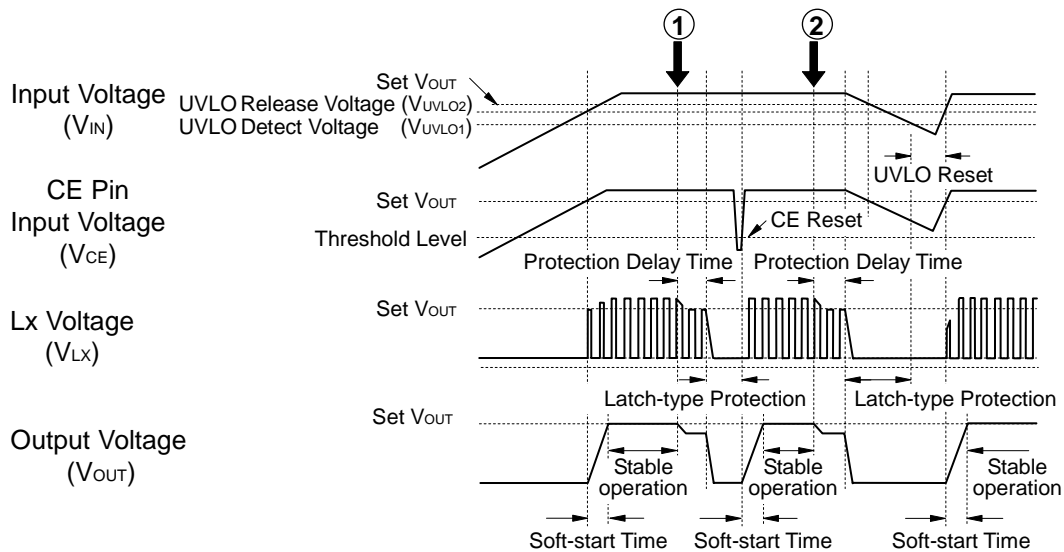

RP500x

TYPICAL CHARACTERISTICS

1) Output Voltage vs. Output Current

RP500x121A/123A

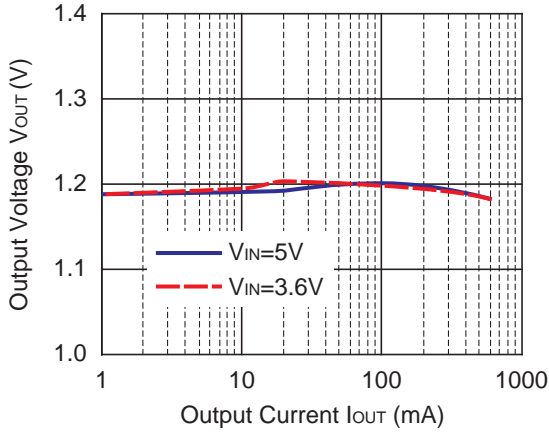

RP500x181A/183A



RP500x251A/253A

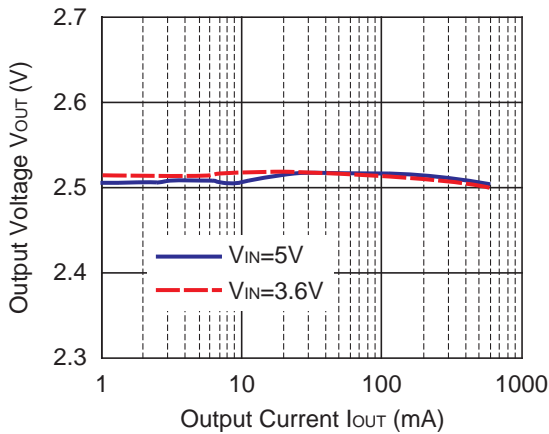

RP500x331A/333A



RP500x152A/154A

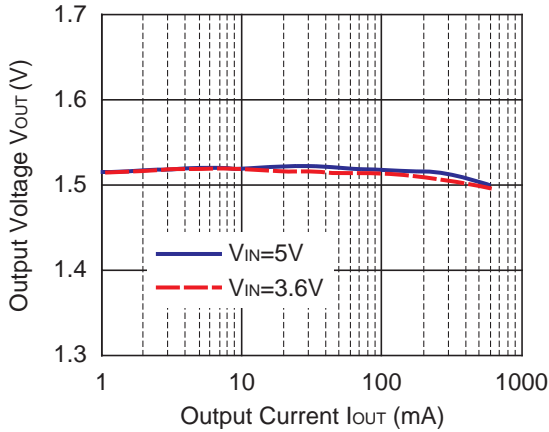

2) Output Voltage vs. Input Voltage

RP500x121A/123A



RP500x251A/253A



RP500x331A/333A



RP500x152A/154A



3) Efficiency vs. Output Current

RP500x121A/123A



RP500x181A/183A



* RP500Z (WLCSP-6-P2) is the non-promotion product. As of March in 2014.

RP500x

RP500x251A/253A



RP500x331A/333A



RP500x152A/154A



4) Supply Current 1, 2 vs. Temperature

RP500x15xA



5) Supply Current 1, 2 vs. Input Voltage

RP500x15xA



6) DC/DC Output Waveform ($C_{IN}=C_{OUT}=10\mu F$, $L=4.7\mu H$)

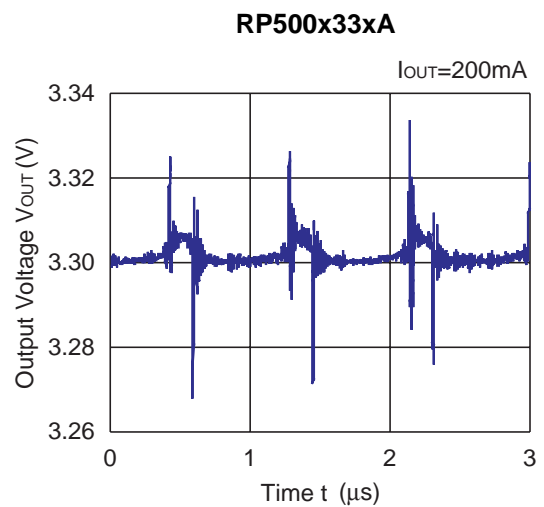
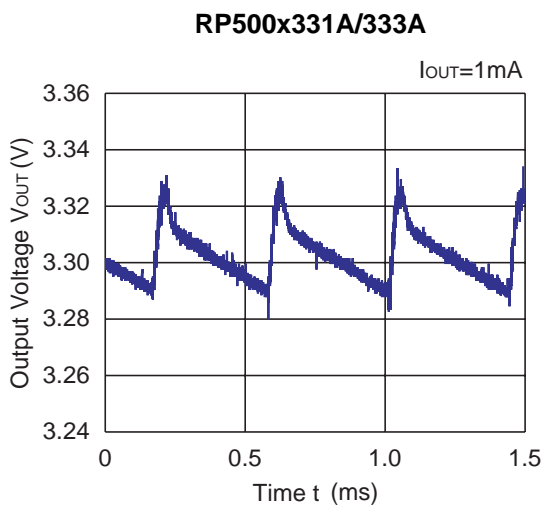
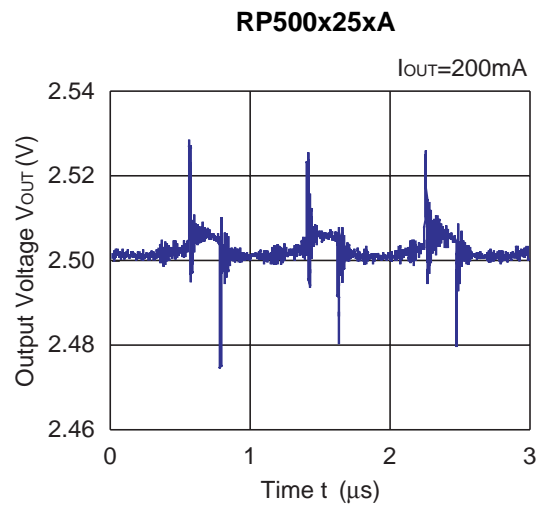
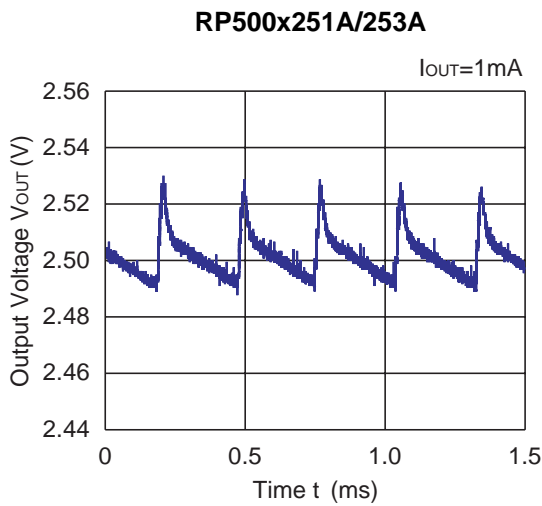
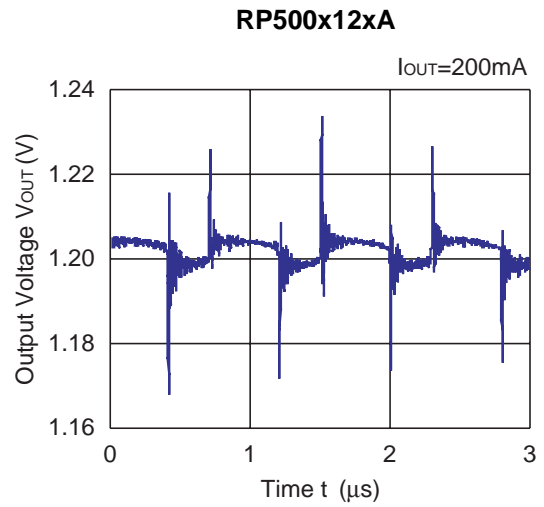
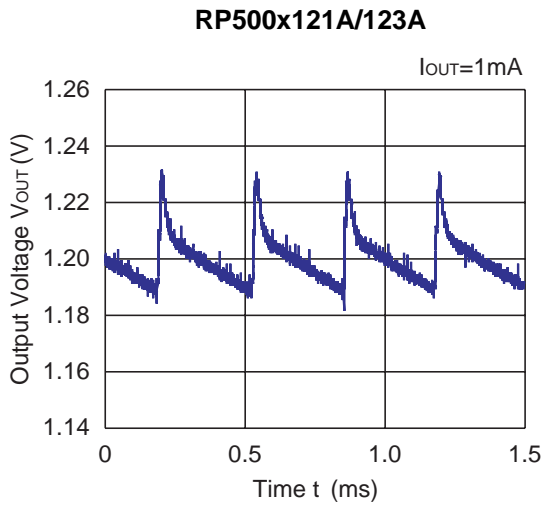

RP500x

7) Output Voltage vs. Temperature

RP500x15xA

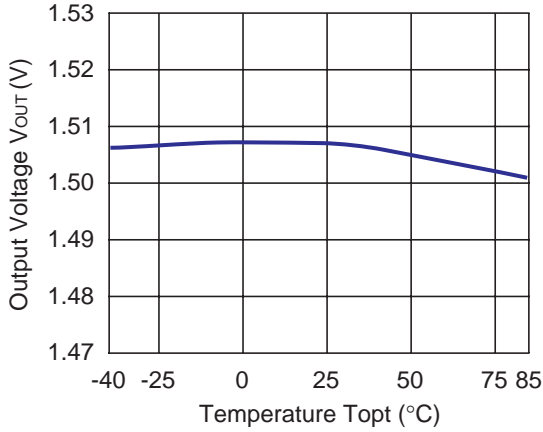

RP500x33xA

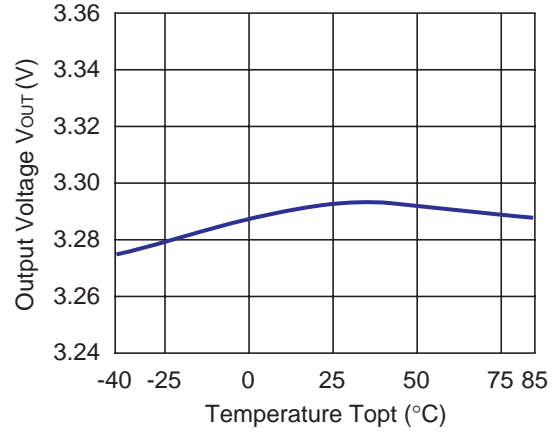

8) Oscillator Frequency vs. Temperature

RP500x15xA

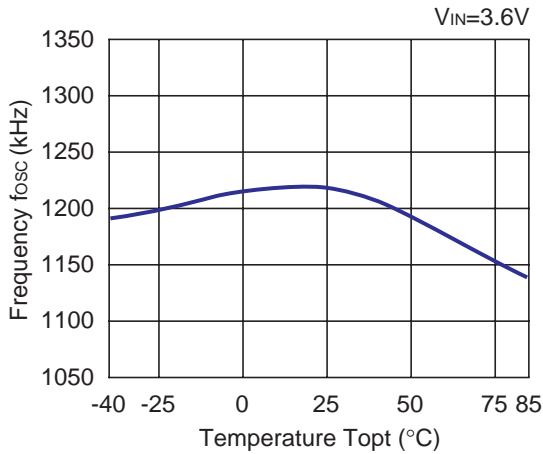

9) Oscillator Frequency vs. Input Voltage

RP500x15xA

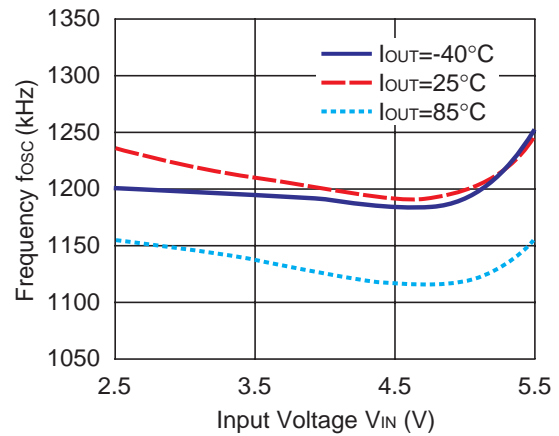

10) Soft-start Time vs. Temperature

RP500x16xA

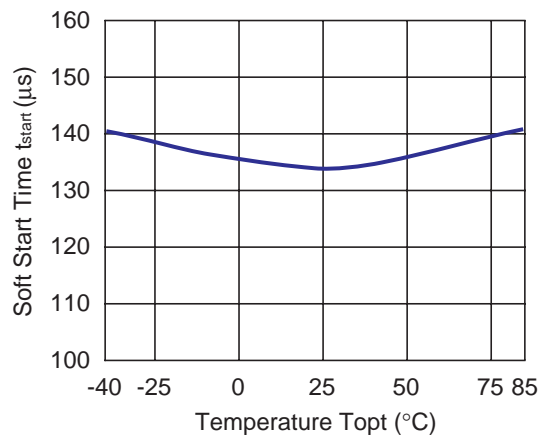

11) UVLO Detector Threshold/ Released Voltage vs. Temperature

RP500x15xA

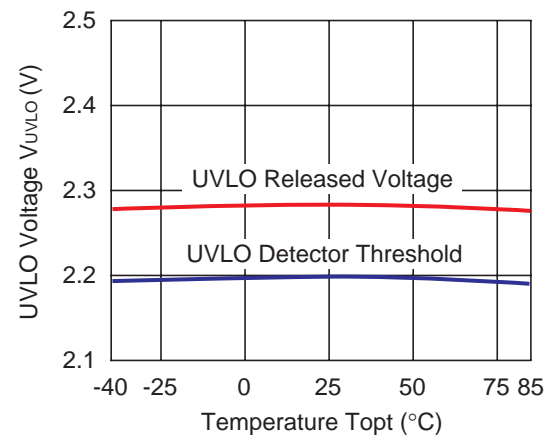

12) CE Input vs. Temperature



13) Lx Current Limit vs. Temperature



14) Nch Tr. ON Resistance vs. Temperature



15) Pch Tr. ON Resistance vs. Temperature



16) Turn on speed with CE pin (C_{IN}=C_{OUT}=Ceramic 10μF, L=4.7μH)



RP500x

RP500x331A/333A ($I_{OUT}=3.3mA$)



RP500x152A/154A ($I_{OUT}=1.5mA$)



17) Load Transient Response ($C_{IN}=C_{OUT}$ =Ceramic $10\mu F$, $L=4.7\mu H$)

RP500x121A/123A

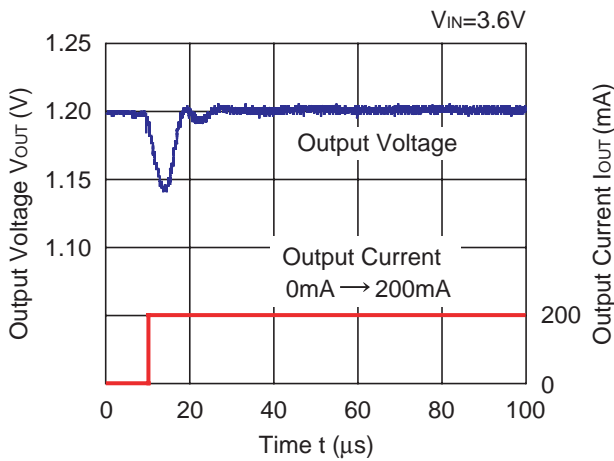

RP500x121A/123A

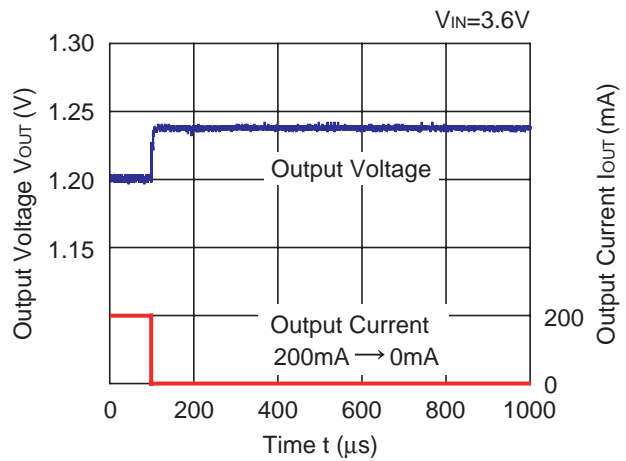

RP500x12xA

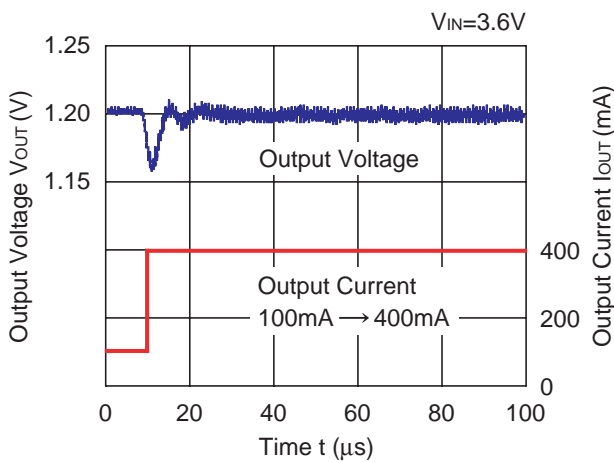

RP500x12xA

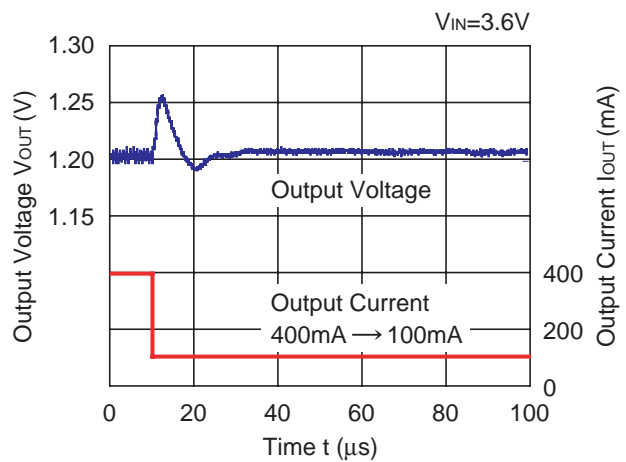

RP500x251A/253A

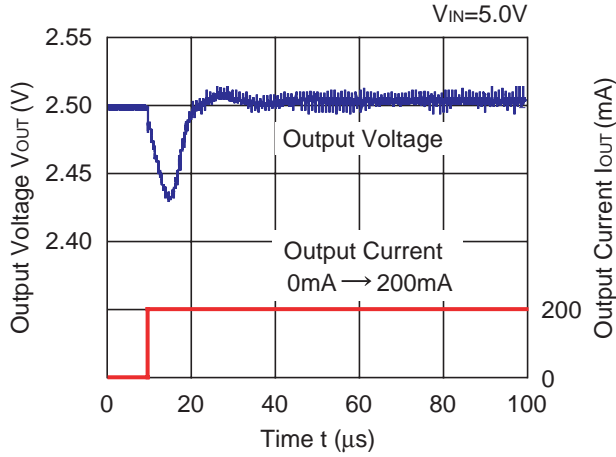

RP500x251A/253A

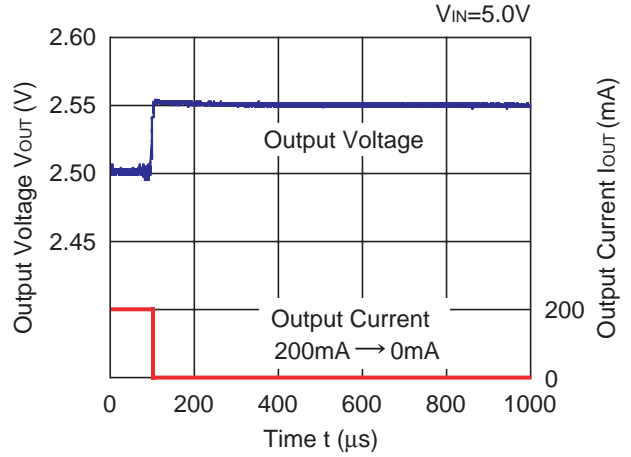

RP500x25xA

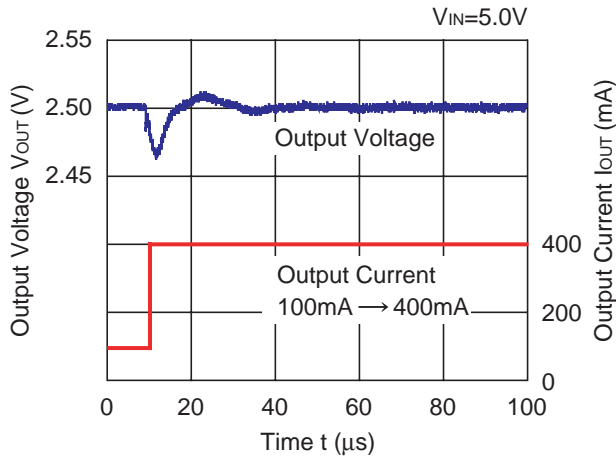

RP500x25xA

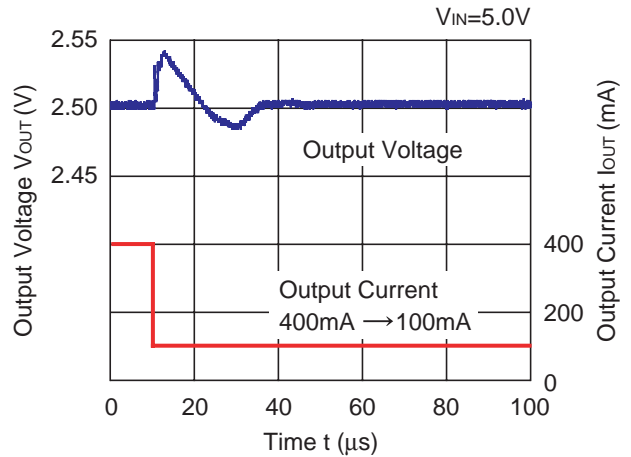

RP500x331A/333A

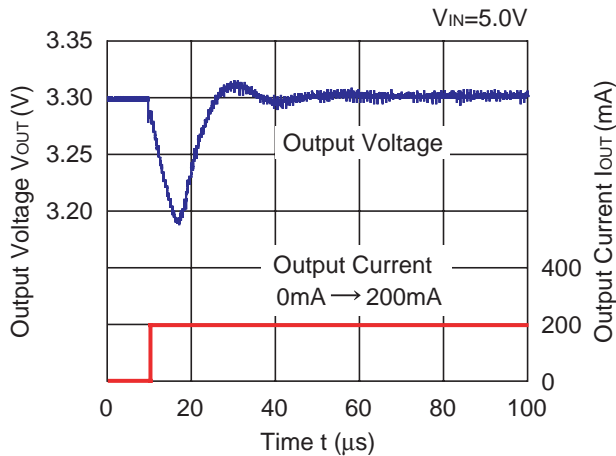

RP500x331A/333A

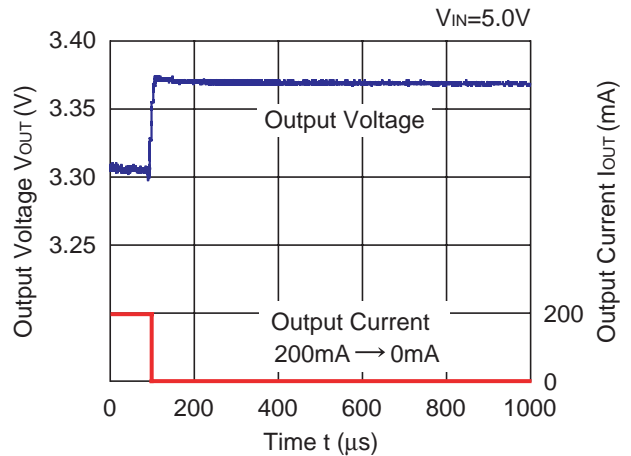

RP500x

RP500x33xA



RP500x33xA



RP500x152A/154A



RP500x152A/154A



RP500x15xA



RP500x15xA





1. The products and the product specifications described in this document are subject to change or discontinuation of production without notice for reasons such as improvement. Therefore, before deciding to use the products, please refer to Ricoh sales representatives for the latest information thereon.
2. The materials in this document may not be copied or otherwise reproduced in whole or in part without prior written consent of Ricoh.
3. Please be sure to take any necessary formalities under relevant laws or regulations before exporting or otherwise taking out of your country the products or the technical information described herein.
4. The technical information described in this document shows typical characteristics of and example application circuits for the products. The release of such information is not to be construed as a warranty of or a grant of license under Ricoh's or any third party's intellectual property rights or any other rights.
5. The products listed in this document are intended and designed for use as general electronic components in standard applications (office equipment, telecommunication equipment, measuring instruments, consumer electronic products, amusement equipment etc.). Those customers intending to use a product in an application requiring extreme quality and reliability, for example, in a highly specific application where the failure or misoperation of the product could result in human injury or death (aircraft, spacevehicle, nuclear reactor control system, traffic control system, automotive and transportation equipment, combustion equipment, safety devices, life support system etc.) should first contact us.
6. We are making our continuous effort to improve the quality and reliability of our products, but semiconductor products are likely to fail with certain probability. In order to prevent any injury to persons or damages to property resulting from such failure, customers should be careful enough to incorporate safety measures in their design, such as redundancy feature, fire containment feature and fail-safe feature. We do not assume any liability or responsibility for any loss or damage arising from misuse or inappropriate use of the products.
7. Anti-radiation design is not implemented in the products described in this document.
8. Please contact Ricoh sales representatives should you have any questions or comments concerning the products or the technical information.



Ricoh is committed to reducing the environmental loading materials in electrical devices with a view to contributing to the protection of human health and the environment.

Ricoh has been providing RoHS compliant products since April 1, 2006 and Halogen-free products since April 1, 2012.

RICOH RICOH ELECTRONIC DEVICES CO., LTD.

<http://www.e-devices.ricoh.co.jp/en/>

Sales & Support Offices

RICOH ELECTRONIC DEVICES CO., LTD.

Higashi-Shinagawa Office (International Sales)
3-32-3, Higashi-Shinagawa, Shinagawa-ku, Tokyo 140-8655, Japan
Phone: +81-3-5479-2857 Fax: +81-3-5479-0502

RICOH EUROPE (NETHERLANDS) B.V.

Semiconductor Support Centre
Prof. W.H. Keesomlaan 1, 1183 DJ Amstelveen, The Netherlands
Phone: +31-20-5474-309

RICOH ELECTRONIC DEVICES KOREA CO., LTD.

3F, Haesung Bldg. 504, Teheran-ro, Gangnam-gu, Seoul, 135-725, Korea
Phone: +82-2-2135-5700 Fax: +82-2-2051-5713

RICOH ELECTRONIC DEVICES SHANGHAI CO., LTD.

Room 403, No.2 Building, No.690 Bilbo Road, Pu Dong New District, Shanghai 201203,
People's Republic of China
Phone: +86-21-5027-3200 Fax: +86-21-5027-3299

RICOH ELECTRONIC DEVICES CO., LTD.

Taipei office
Room 109, 10F-1, No.51, Hengyang Rd., Taipei City, Taiwan (R.O.C.)
Phone: +886-2-2313-1621/1622 Fax: +886-2-2313-1623

Mouser Electronics

Authorized Distributor

Click to View Pricing, Inventory, Delivery & Lifecycle Information:

[Ricoch Electronics:](#)

[RP500N151A-TR-FE](#) [RP500N181A-TR-FE](#) [RP500N333A-TR-FE](#) [RP500K121A-TR](#) [RP500N251A-TR-FE](#)
[RP500K181A-TR](#) [RP500K184A-TR](#) [RP500K331A-TR](#) [RP500N121A-TR-FE](#) [RP500N331A-TR-FE](#)



Компания «ЭлектроПласт» предлагает заключение долгосрочных отношений при поставках импортных электронных компонентов на взаимовыгодных условиях!

Наши преимущества:

- Оперативные поставки широкого спектра электронных компонентов отечественного и импортного производства напрямую от производителей и с крупнейших мировых складов;
- Поставка более 17-ти миллионов наименований электронных компонентов;
- Поставка сложных, дефицитных, либо снятых с производства позиций;
- Оперативные сроки поставки под заказ (от 5 рабочих дней);
- Экспресс доставка в любую точку России;
- Техническая поддержка проекта, помощь в подборе аналогов, поставка прототипов;
- Система менеджмента качества сертифицирована по Международному стандарту ISO 9001;
- Лицензия ФСБ на осуществление работ с использованием сведений, составляющих государственную тайну;
- Поставка специализированных компонентов (Xilinx, Altera, Analog Devices, Intersil, Interpoint, Microsemi, Aeroflex, Peregrine, Syfer, Eurofarad, Texas Instrument, Miteq, Cobham, E2V, MA-COM, Hittite, Mini-Circuits, General Dynamics и др.);

Помимо этого, одним из направлений компании «ЭлектроПласт» является направление «Источники питания». Мы предлагаем Вам помощь Конструкторского отдела:

- Подбор оптимального решения, техническое обоснование при выборе компонента;
- Подбор аналогов;
- Консультации по применению компонента;
- Поставка образцов и прототипов;
- Техническая поддержка проекта;
- Защита от снятия компонента с производства.



Как с нами связаться

Телефон: 8 (812) 309 58 32 (многоканальный)

Факс: 8 (812) 320-02-42

Электронная почта: org@eplast1.ru

Адрес: 198099, г. Санкт-Петербург, ул. Калинина, дом 2, корпус 4, литера А.