

NL17SGU04

Unbuffered Inverter

The NL17SGU04 MiniGate™ is an advanced high-speed CMOS unbuffered inverter in ultra-small footprint.

The NL17SGU04 input structures provides protection when voltages up to 4.6 V are applied.

Features

- Wide Operating V_{CC} Range: 0.9 V to 3.6 V
- High Speed: $t_{PD} = 1.9$ ns (Typ) at $V_{CC} = 3.0$ V, $C_L = 15$ pF
- Low Power Dissipation: $I_{CC} = 0.5$ μ A (Max) at $T_A = 25^\circ$ C
- 4.6 V Overvoltage Tolerant (OVT) Input Pins
- Ultra-Small Packages
- NLV Prefix for Automotive and Other Applications Requiring Unique Site and Control Change Requirements; AEC-Q100 Qualified and PPAP Capable
- These Devices are Pb-Free, Halogen Free/BFR Free and are RoHS Compliant

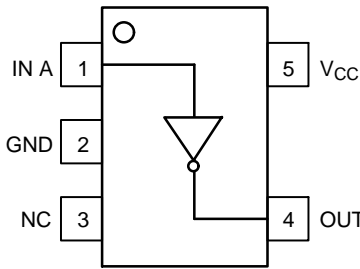

Figure 1. SOT-953
(Top Thru View)

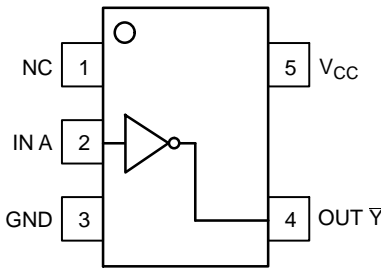

Figure 2. SC-88A
(Top View)

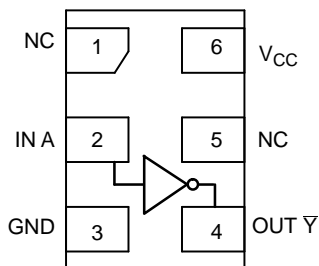

Figure 3. UDFN
(Top View)

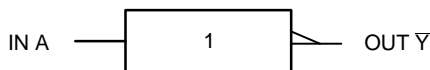

Figure 4. Logic Symbol



ON Semiconductor®

<http://onsemi.com>

MARKING DIAGRAMS

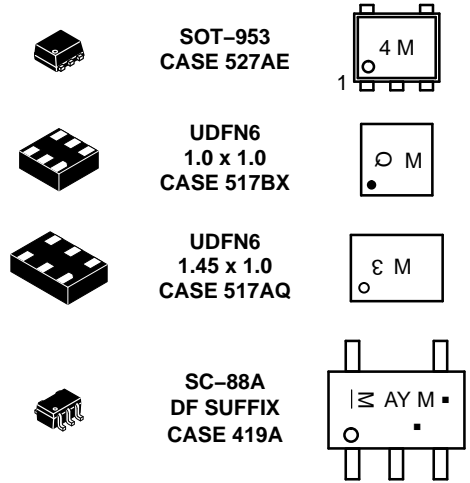

M = Date Code*
▪ = Pb-Free Package

(Note: Microdot may be in either location)

*Date Code orientation and/or position may vary depending upon manufacturing location.

PIN ASSIGNMENT

	SOT-953	SC-88A	UDFN6
1	IN A	NC	NC
2	GND	IN A	IN A
3	NC	GND	GND
4	OUT \bar{Y}	OUT \bar{Y}	OUT \bar{Y}
5	V_{CC}	V_{CC}	NC
6			V_{CC}

FUNCTION TABLE

A Input	\bar{Y} Output
L	H
H	L

ORDERING INFORMATION

See detailed ordering and shipping information on page 5 of this data sheet.

NL17SGU04

MAXIMUM RATINGS

Symbol	Parameter	Value	Unit
V _{CC}	DC Supply Voltage	-0.5 to +5.5	V
V _{IN}	DC Input Voltage	-0.5 to +4.6	V
V _{OUT}	DC Output Voltage Output at High or Low State Power-Down Mode (V _{CC} = 0 V)	-0.5 to V _{CC} +0.5 -0.5 to +4.6	V
I _{IK}	DC Input Diode Current V _{IN} < GND	-20	mA
I _{OK}	DC Output Diode Current V _{OUT} < GND	-20	mA
I _{OUT}	DC Output Source/Sink Current	±20	mA
I _{CC}	DC Supply Current per Supply Pin	±20	mA
I _{GND}	DC Ground Current per Ground Pin	±20	mA
T _{STG}	Storage Temperature Range	-65 to +150	°C
T _L	Lead Temperature, 1 mm from Case for 10 Seconds	260	°C
T _J	Junction Temperature Under Bias	+150	°C
MSL	Moisture Sensitivity	Level 1	
FR	Flammability Rating Oxygen Index: 28 to 34	UL 94 V-0 @ 0.125 in	
V _{ESD}	ESD Withstand Voltage Human Body Model (Note 2) Machine Model (Note 3)	>2000 >150	V
I _{LATCHUP}	Latchup Performance Above V _{CC} and Below GND at 125°C (Note 4)	±100	mA

Stresses exceeding those listed in the Maximum Ratings table may damage the device. If any of these limits are exceeded, device functionality should not be assumed, damage may occur and reliability may be affected.

1. Measured with minimum pad spacing on an FR4 board, using 10 mm-by-1 inch, 2-ounce copper trace with no air flow.
2. Tested to EIA/JESD22-A114-A.
3. Tested to EIA/JESD22-A115-A.
4. Tested to EIA/JESD78.

RECOMMENDED OPERATING CONDITIONS

Symbol	Characteristics	Min	Max	Unit
V _{CC}	Positive DC Supply Voltage	0.9	3.6	V
V _{IN}	Digital Input Voltage	0.0	3.6	V
V _{OUT}	Output Voltage Output at High or Low State Power-Down Mode (V _{CC} = 0 V)	0.0 0.0	V _{CC} 3.6	V
T _A	Operating Temperature Range	-55	+125	°C
Δt / ΔV	Input Transition Rise or Fall Rate V _{CC} = 3.3 V ± 0.3 V	0	10	ns/V

Functional operation above the stresses listed in the Recommended Operating Ranges is not implied. Extended exposure to stresses beyond the Recommended Operating Ranges limits may affect device reliability.

NL17SGU04

DC ELECTRICAL CHARACTERISTICS

Symbol	Parameter	Conditions	V _{CC} (V)	T _A = 25°C		T _A = -55°C to +125°C		Unit
				Min	Max	Min	Max	
V _{IH}	High-Level Input Voltage		0.9	V _{CC}		V _{CC}		V
			1.1 to 1.3	0.7xV _{CC}		0.7xV _{CC}		
			1.4 to 1.6	0.65xV _{CC}		0.65xV _{CC}		
			1.65 to 1.95	0.65xV _{CC}		0.65xV _{CC}		
			2.3 to 2.7	1.7		1.7		
			3.0 to 3.6	2.0		2.0		
V _{IL}	Low-Level Input Voltage		0.9		GND		GND	V
			1.1 to 1.3		0.3xV _{CC}		0.3xV _{CC}	
			1.4 to 1.6		0.35xV _{CC}		0.35xV _{CC}	
			1.65 to 1.95		0.35xV _{CC}		0.35xV _{CC}	
			2.3 to 2.7		0.7		0.7	
			3.0 to 3.6		0.8		0.8	
V _{OH}	High-Level Output Voltage	V _{IN} = V _{IH} or V _{IL}	I _{OH} = -20 μA	0.9	0.75		0.75	V
			I _{OH} = -0.3 mA	1.1 to 1.3	0.75xV _{CC}		0.75xV _{CC}	
			I _{OH} = -1.7 mA	1.4 to 1.6	0.75xV _{CC}		0.75xV _{CC}	
			I _{OH} = -3.0 mA	1.65 to 1.95	V _{CC} -0.45		V _{CC} -0.45	
			I _{OH} = -4.0 mA	2.3 to 2.7	2.0		2.0	
			I _{OH} = -8.0 mA	3.0 to 3.6	2.48		2.48	
V _{OL}	Low-Level Output Voltage	V _{IN} = V _{IH} or V _{IL}	I _{OL} = 20 μA	0.9		0.1	0.1	V
			I _{OL} = 0.3 mA	1.1 to 1.3		0.25xV _{CC}	0.25xV _{CC}	
			I _{OL} = 1.7 mA	1.4 to 1.6		0.25xV _{CC}	0.25xV _{CC}	
			I _{OL} = 3.0 mA	1.65 to 1.95		0.45	0.45	
			I _{OL} = 4.0 mA	2.3 to 2.7		0.4	0.4	
			I _{OL} = 8.0 mA	3.0 to 3.6		0.4	0.4	
I _{IN}	Input Leakage Current	0 ≤ V _{IN} ≤ 3.6 V	0 to 3.6		±0.1		±1.0	μA
I _{CC}	Quiescent Supply Current	V _{IN} = V _{CC} or GND	3.6		0.5		10.0	μA

Product parametric performance is indicated in the Electrical Characteristics for the listed test conditions, unless otherwise noted. Product performance may not be indicated by the Electrical Characteristics if operated under different conditions.

NL17SGU04

AC ELECTRICAL CHARACTERISTICS Input $t_r = t_f = 3.0$ ns

Symbol	Parameter	Test Condition	V_{CC} (V)	$T_A = 25^\circ\text{C}$			$T_A = -55^\circ\text{C to } +125^\circ\text{C}$		Unit
				Min	Typ	Max	Min	Max	
t_{PLH} , t_{PHL}	Propagation Delay, A to Y	$C_L = 10$ pF, $R_L = 1$ M Ω	0.9	-	8.0	10.3	-	13.3	ns
			1.1 to 1.3	-	6.0	9.4	-	12.2	
			1.4 to 1.6	-	3.2	8.5	-	10.0	
			1.65 to 1.95	-	2.6	6.2	-	6.7	
			2.3 to 2.7	-	2.0	3.9	-	4.4	
			3.0 to 3.6	-	1.7	3.1	-	3.7	
		$C_L = 15$ pF, $R_L = 1$ M Ω	0.9	-	19.5	11.7	-	14.5	ns
			1.1 to 1.3	-	7.0	9.2	-	12.2	
			1.4 to 1.6	-	3.5	6.3	-	10.2	
			1.65 to 1.95	-	3.0	5.9	-	7.1	
			2.3 to 2.7	-	2.3	4.4	-	5.0	
			3.0 to 3.6	-	1.9	3.4	-	3.9	
		$C_L = 30$ pF, $R_L = 1$ M Ω	0.9	-	10.0	12.5	-	15.6	ns
			1.1 to 1.3	-	9.0	11.6	-	13.8	
			1.4 to 1.6	-	6.0	9.1	-	12.9	
			1.65 to 1.95	-	4.5	8.2	-	9.6	
			2.3 to 2.7	-	3.2	5.7	-	6.1	
			3.0 to 3.6	-	2.5	4.4	-	4.8	
C_{IN}	Input Capacitance		0 to 3.6		3	-	-	pF	
C_O	Output Capacitance	$V_O = \text{GND}$	0		3	-	-	pF	
C_{PD}	Power Dissipation Capacitance (Note 5)	$f = 10$ MHz	0.9 to 3.6	-	4	-	-	pF	

Product parametric performance is indicated in the Electrical Characteristics for the listed test conditions, unless otherwise noted. Product performance may not be indicated by the Electrical Characteristics if operated under different conditions.

5. C_{PD} is defined as the value of the internal equivalent capacitance which is calculated from the operating current consumption without load. Average operating current can be obtained by the equation: $I_{CC(OPR)} = C_{PD} \cdot V_{CC} \cdot f_{in} + I_{CC}$. C_{PD} is used to determine the no-load dynamic power consumption; $P_D = C_{PD} \cdot V_{CC}^2 \cdot f_{in} + I_{CC} \cdot V_{CC}$.

NL17SGU04

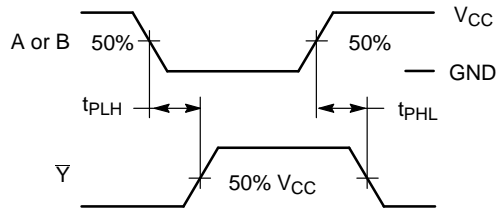
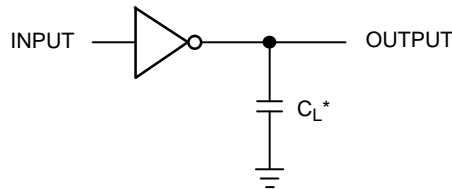

Figure 5. Switching Waveforms



*Includes all probe and jig capacitances
A 1-MHz square input wave is recommended for propagation delay tests.

Figure 6. Test Circuit

ORDERING INFORMATION

Device	Package	Shipping†
NL17SGU04P5T5G	SOT-953 (Pb-Free)	8000 / Tape & Reel
NL17SGU04DFT2G	SC-88A (Pb-Free)	3000 / Tape & Reel
NLV17SGU04DFT2G*	SC-88A (Pb-Free)	3000 / Tape & Reel
NL17SGU04AMUTCG (In Development)	UDFN6 1.45x1 mm (Pb-Free)	3000 / Tape & Reel
NL17SGU04CMUTCG (In Development)	UDFN6 1x1 mm (Pb-Free)	3000 / Tape & Reel

†For information on tape and reel specifications, including part orientation and tape sizes, please refer to our Tape and Reel Packaging Specifications Brochure, BRD8011/D.

*NLV Prefix for Automotive and Other Applications Requiring Unique Site and Control Change Requirements; AEC-Q100 Qualified and PPAP Capable.

NL17SGU04

PACKAGE DIMENSIONS

SOT-953
CASE 527AE
ISSUE E

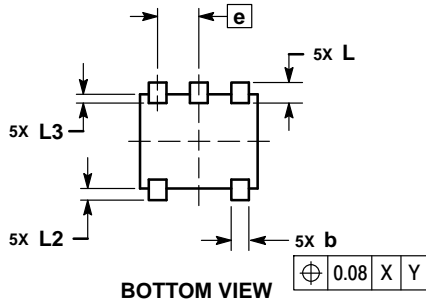
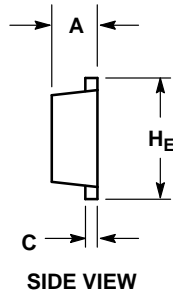
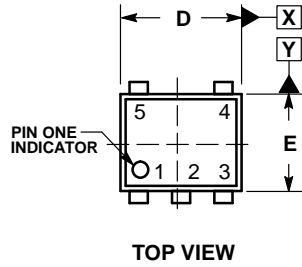

NOTES:

1. DIMENSIONING AND TOLERANCING PER ASME Y14.5M, 1994.
2. CONTROLLING DIMENSION: MILLIMETERS
3. MAXIMUM LEAD THICKNESS INCLUDES LEAD FINISH. MINIMUM LEAD THICKNESS IS THE MINIMUM THICKNESS OF THE BASE MATERIAL.
4. DIMENSIONS D AND E DO NOT INCLUDE MOLD FLASH, PROTRUSIONS, OR GATE BURRS.

DIM	MILLIMETERS		
	MIN	NOM	MAX
A	0.34	0.37	0.40
b	0.10	0.15	0.20
C	0.07	0.12	0.17
D	0.95	1.00	1.05
E	0.75	0.80	0.85
e	0.35 BSC		
HE	0.95	1.00	1.05
L	0.175 REF		
L2	0.05	0.10	0.15
L3	---	---	0.15

SOLDERING FOOTPRINT*

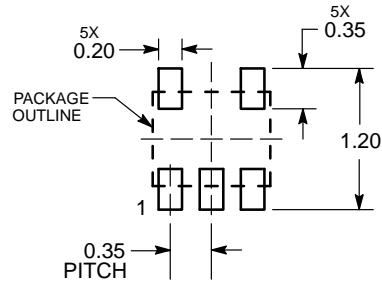

DIMENSIONS: MILLIMETERS

*For additional information on our Pb-Free strategy and soldering details, please download the ON Semiconductor Soldering and Mounting Techniques Reference Manual, SOLDERRM/D.

NL17SGU04

PACKAGE DIMENSIONS

UDFN6 1.0x1.0, 0.35P
CASE 517BX
ISSUE O



NOTES:

1. DIMENSIONING AND TOLERANCING PER ASME Y14.5M, 1994.
2. CONTROLLING DIMENSION: MILLIMETERS.
3. DIMENSION b APPLIES TO PLATED TERMINAL AND IS MEASURED BETWEEN 0.15 AND 0.20 MM FROM TERMINAL TIP.
4. PACKAGE DIMENSIONS EXCLUSIVE OF BURRS AND MOLD FLASH.

DIM	MILLIMETERS	
	MIN	MAX
A	0.45	0.55
A1	0.00	0.05
A3	0.13 REF	
b	0.12	0.22
D	1.00 BSC	
E	1.00 BSC	
e	0.35 BSC	
L	0.25	0.35
L1	0.30	0.40

RECOMMENDED SOLDERING FOOTPRINT*

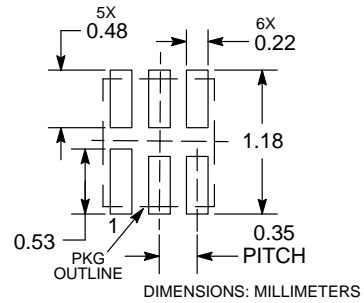

*For additional information on our Pb-Free strategy and soldering details, please download the ON Semiconductor Soldering and Mounting Techniques Reference Manual, SOLDERRM/D.

NL17SGU04

PACKAGE DIMENSIONS

UDFN6 1.45x1.0, 0.5P
CASE 517AQ
ISSUE O

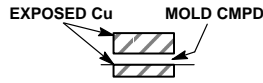
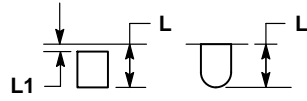

- NOTES:
1. DIMENSIONING AND TOLERANCING PER ASME Y14.5M, 1994.
 2. CONTROLLING DIMENSION: MILLIMETERS.
 3. DIMENSION b APPLIES TO PLATED TERMINAL AND IS MEASURED BETWEEN 0.15 AND 0.30 mm FROM THE TERMINAL TIP.

MILLIMETERS		
DIM	MIN	MAX
A	0.45	0.55
A1	0.00	0.05
A2	0.07 REF	
b	0.20	0.30
D	1.45 BSC	
E	1.00 BSC	
e	0.50 BSC	
L	0.30	0.40
L1	---	0.15

MOUNTING FOOTPRINT

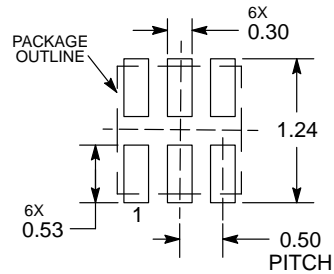

DIMENSIONS: MILLIMETERS

*For additional information on our Pb-Free strategy and soldering details, please download the ON Semiconductor Soldering and Mounting Techniques Reference Manual, SOLDERRM/D.

NL17SGU04

PACKAGE DIMENSIONS

SC-88A (SC-70-5/SOT-353)
CASE 419A-02
ISSUE L

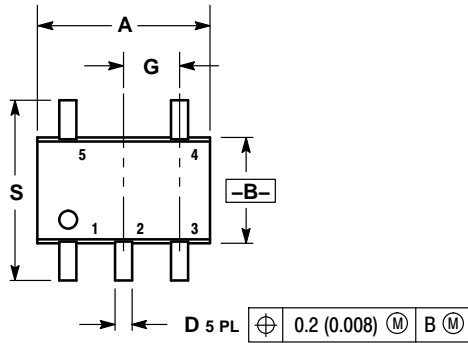

NOTES:

1. DIMENSIONING AND TOLERANCING PER ANSI Y14.5M, 1982.
2. CONTROLLING DIMENSION: INCH.
3. 419A-01 OBSOLETE. NEW STANDARD 419A-02.
4. DIMENSIONS A AND B DO NOT INCLUDE MOLD FLASH, PROTRUSIONS, OR GATE BURRS.

DIM	INCHES		MILLIMETERS	
	MIN	MAX	MIN	MAX
A	0.071	0.087	1.80	2.20
B	0.045	0.053	1.15	1.35
C	0.031	0.043	0.80	1.10
D	0.004	0.012	0.10	0.30
G	0.026 BSC		0.65 BSC	
H	---	0.004	---	0.10
J	0.004	0.010	0.10	0.25
K	0.004	0.012	0.10	0.30
N	0.008 REF		0.20 REF	
S	0.079	0.087	2.00	2.20

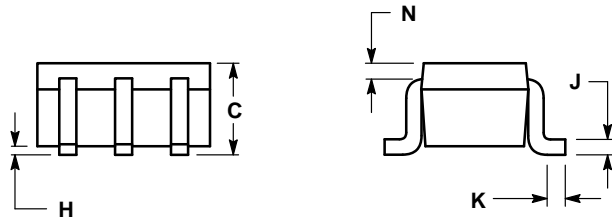

SOLDER FOOTPRINT*

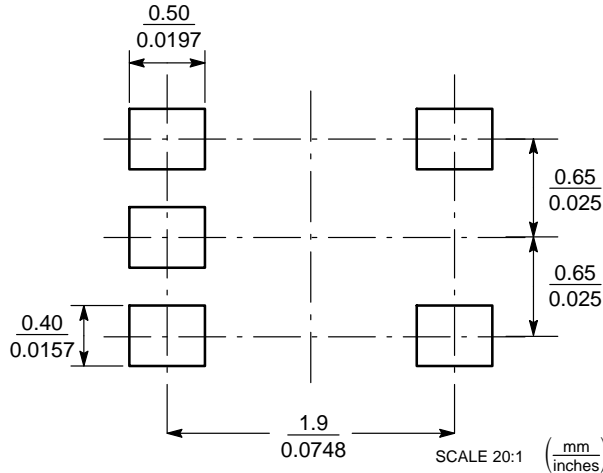

*For additional information on our Pb-Free strategy and soldering details, please download the ON Semiconductor Soldering and Mounting Techniques Reference Manual, SOLDERRM/D.

MiniGate is a trademark of Semiconductor Components Industries, LLC (SCILLC).

ON Semiconductor and are registered trademarks of Semiconductor Components Industries, LLC (SCILLC). SCILLC owns the rights to a number of patents, trademarks, copyrights, trade secrets, and other intellectual property. A listing of SCILLC's product/patent coverage may be accessed at www.onsemi.com/site/pdf/Patent-Marking.pdf. SCILLC reserves the right to make changes without further notice to any products herein. SCILLC makes no warranty, representation or guarantee regarding the suitability of its products for any particular purpose, nor does SCILLC assume any liability arising out of the application or use of any product or circuit, and specifically disclaims any and all liability, including without limitation special, consequential or incidental damages. "Typical" parameters which may be provided in SCILLC data sheets and/or specifications can and do vary in different applications and actual performance may vary over time. All operating parameters, including "Typicals" must be validated for each customer application by customer's technical experts. SCILLC does not convey any license under its patent rights nor the rights of others. SCILLC products are not designed, intended, or authorized for use as components in systems intended for surgical implant into the body, or other applications intended to support or sustain life, or for any other application in which the failure of the SCILLC product could create a situation where personal injury or death may occur. Should Buyer purchase or use SCILLC products for any such unintended or unauthorized application, Buyer shall indemnify and hold SCILLC and its officers, employees, subsidiaries, affiliates, and distributors harmless against all claims, costs, damages, and expenses, and reasonable attorney fees arising out of, directly or indirectly, any claim of personal injury or death associated with such unintended or unauthorized use, even if such claim alleges that SCILLC was negligent regarding the design or manufacture of the part. SCILLC is an Equal Opportunity/Affirmative Action Employer. This literature is subject to all applicable copyright laws and is not for resale in any manner.

PUBLICATION ORDERING INFORMATION

LITERATURE FULFILLMENT:
Literature Distribution Center for ON Semiconductor
P.O. Box 5163, Denver, Colorado 80217 USA
Phone: 303-675-2175 or 800-344-3860 Toll Free USA/Canada
Fax: 303-675-2176 or 800-344-3867 Toll Free USA/Canada
Email: orderlit@onsemi.com

N. American Technical Support: 800-282-9855 Toll Free
USA/Canada
Europe, Middle East and Africa Technical Support:
Phone: 421 33 790 2910
Japan Customer Focus Center
Phone: 81-3-5817-1050

ON Semiconductor Website: www.onsemi.com
Order Literature: <http://www.onsemi.com/orderlit>
For additional information, please contact your local Sales Representative



Компания «ЭлектроПласт» предлагает заключение долгосрочных отношений при поставках импортных электронных компонентов на взаимовыгодных условиях!

Наши преимущества:

- Оперативные поставки широкого спектра электронных компонентов отечественного и импортного производства напрямую от производителей и с крупнейших мировых складов;
- Поставка более 17-ти миллионов наименований электронных компонентов;
- Поставка сложных, дефицитных, либо снятых с производства позиций;
- Оперативные сроки поставки под заказ (от 5 рабочих дней);
- Экспресс доставка в любую точку России;
- Техническая поддержка проекта, помощь в подборе аналогов, поставка прототипов;
- Система менеджмента качества сертифицирована по Международному стандарту ISO 9001;
- Лицензия ФСБ на осуществление работ с использованием сведений, составляющих государственную тайну;
- Поставка специализированных компонентов (Xilinx, Altera, Analog Devices, Intersil, Interpoint, Microsemi, Aeroflex, Peregrine, Syfer, Eurofarad, Texas Instrument, Miteq, Cobham, E2V, MA-COM, Hittite, Mini-Circuits, General Dynamics и др.);

Помимо этого, одним из направлений компании «ЭлектроПласт» является направление «Источники питания». Мы предлагаем Вам помощь Конструкторского отдела:

- Подбор оптимального решения, техническое обоснование при выборе компонента;
- Подбор аналогов;
- Консультации по применению компонента;
- Поставка образцов и прототипов;
- Техническая поддержка проекта;
- Защита от снятия компонента с производства.



Как с нами связаться

Телефон: 8 (812) 309 58 32 (многоканальный)

Факс: 8 (812) 320-02-42

Электронная почта: org@eplast1.ru

Адрес: 198099, г. Санкт-Петербург, ул. Калинина, дом 2, корпус 4, литера А.