

**MAXIM**

# 3ppm/°C, Low-Power, Low-Dropout Voltage Reference

**MAX6133**

## General Description

The MAX6133 high-precision, low-power, low-dropout voltage reference features a low 3ppm/°C (max) temperature coefficient and a low dropout voltage (200mV, max). This series-mode device features bandgap technology for low-noise performance and excellent accuracy. Load regulation specifications are guaranteed for source currents up to 15mA. The laser-trimmed, high-stability thin-film resistors, together with post-package trimming, guarantee an excellent initial accuracy specification (0.04%, max). The MAX6133 is a series voltage reference and consumes only 40µA of supply current (virtually independent of supply voltage). Series-mode references save system power and use minimal external components compared to 2-terminal shunt references.

The MAX6133 is available in 8-pin µMAX and SO packages. The unique blend of tiny packaging and excellent precision performance make these parts ideally suited for portable and communication applications.

## Applications

Precision Regulators  
A/D and D/A Converters  
Power Supplies  
High-Accuracy Industrial and Process Control  
Hand-Held Instruments

## Features

- ◆ Low Temperature Coefficient  
3ppm/°C (max), SO  
5ppm/°C (max), µMAX
- ◆ Tiny 5mm × 3mm µMAX Package
- ◆ Low 200mV (max) Dropout Voltage
- ◆ Low 40µA Quiescent Current
- ◆ ±0.04% (max) Initial Accuracy
- ◆ Low 16µV<sub>P-P</sub> Noise (0.1Hz to 10Hz) (2.5V Output)
- ◆ 15mA Output Source-Current Capability
- ◆ Wide 2.7V to 12.6V Supply Voltage
- ◆ Excellent Line (30µV/V, max) and Load (0.05mV/mA, max) Regulation

## Selector Guide

SUFFIX	VOLTAGE OUTPUT
25	2.500V
30	3.000V
41	4.096V
50	5.000V

## Ordering Information

PART	TEMP RANGE	PIN-PACKAGE	MAXIMUM INITIAL ACCURACY (%)	MAXIMUM TEMPCO (ppm/°C, -40°C to +85°C)
MAX6133A_ _	-40°C to +125°C	8 µMAX	0.06	5
MAX6133AASA_ _	-40°C to +125°C	8 SO	0.04	3
MAX6133BASA_ _	-40°C to +125°C	8 SO	0.08	5

**Note:** Two-number part suffix indicates output voltage option.

## Typical Operating Circuit

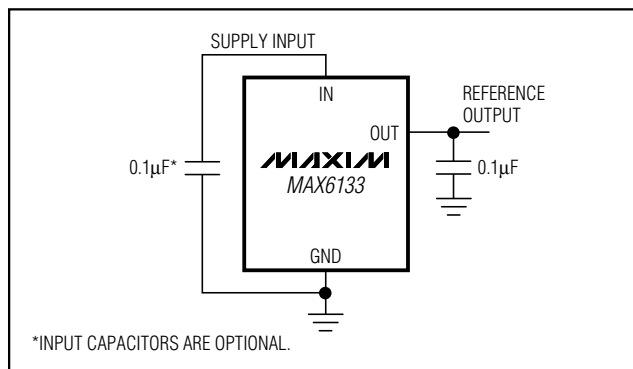

## Pin Configuration

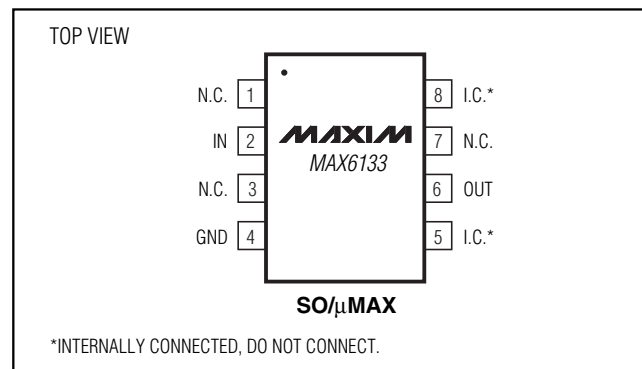
**MAXIM**

Maxim Integrated Products 1

**For pricing, delivery, and ordering information, please contact Maxim/Dallas Direct! at 1-888-629-4642, or visit Maxim's website at [www.maxim-ic.com](http://www.maxim-ic.com).**

# 3ppm/°C, Low-Power, Low-Dropout Voltage Reference

## ABSOLUTE MAXIMUM RATINGS

Voltage (with Respect to GND)  
 IN .....-0.3V to +13V  
 OUT .....-0.3V to +6V or ( $V_{IN} + 0.3V$ )  
 OUT Short Circuit to IN or GND Duration .....60s  
 Continuous Power Dissipation ( $T_A = +70^\circ\text{C}$ )  
 8-Pin  $\mu\text{MAX}$  (derate 5.5mW/°C above +70°C) .....362mW  
 8-Pin SO (derate 5.88mW/°C above +70°C) .....471mW

Operating Temperature Range .....-40°C to +125°C  
 Storage Temperature Range .....-65°C to +150°C  
 Junction Temperature .....+150°C  
 Lead Temperature (soldering, 10s) .....+300°C

Stresses beyond those listed under "Absolute Maximum Ratings" may cause permanent damage to the device. These are stress ratings only, and functional operation of the device at these or any other conditions beyond those indicated in the operational sections of the specifications is not implied. Exposure to absolute maximum rating conditions for extended periods may affect device reliability.

## ELECTRICAL CHARACTERISTICS—MAX6133\_25 ( $V_{OUT} = 2.500V$ )

( $V_{IN} = 5V$ ,  $C_{LOAD} = 0.1\mu\text{F}$ ,  $I_{OUT} = 0$ ,  $T_A = T_{MIN}$  to  $T_{MAX}$ . Typical values are at  $T_A = +25^\circ\text{C}$ , unless otherwise noted.)

PARAMETER	SYMBOL	CONDITIONS		MIN	TYP	MAX	UNITS
Output Voltage	$V_{OUT}$	$T_A = +25^\circ\text{C}$	A grade SO	2.4990	2.5000	2.5010	V
			B grade SO	2.4980	2.5000	2.5020	
			$\mu\text{MAX}$	2.4985	2.5000	2.5015	
Output Voltage Accuracy		$T_A = +25^\circ\text{C}$	A grade SO	-0.04		+0.04	%
			B grade SO	-0.08		+0.08	
			$\mu\text{MAX}$	-0.06		+0.06	
Output Voltage Temperature Coefficient (Note 1)	$TCV_{OUT}$	A grade SO	$T_A = -40^\circ\text{C}$ to $+85^\circ\text{C}$		1	3	ppm/°C
			$T_A = -40^\circ\text{C}$ to $+125^\circ\text{C}$		4	7	
		B grade SO	$T_A = -40^\circ\text{C}$ to $+85^\circ\text{C}$		3	5	
			$T_A = -40^\circ\text{C}$ to $+125^\circ\text{C}$		5	10	
		$\mu\text{MAX}$	$T_A = -40^\circ\text{C}$ to $+85^\circ\text{C}$		1	5	
			$T_A = -40^\circ\text{C}$ to $+125^\circ\text{C}$		2	7	
Input Voltage Range	$V_{IN}$	Inferred from line regulation		2.7		12.6	V
Line Regulation	$\Delta V_{OUT}/\Delta V_{IN}$	$2.7V \leq V_{IN} \leq 12.6V$			2	30	$\mu\text{V}/V$
Load Regulation	$\Delta V_{OUT}/\Delta I_{OUT}$	$-100\mu\text{A} \leq I_{OUT} \leq 15\text{mA}$			0.003	0.05	mV/mA
Dropout Voltage (Note 2)	$V_{DO}$	$\Delta V_{OUT} = 0.1\%$ , $I_{OUT} = 1\text{mA}$			0.02	0.2	V
		$\Delta V_{OUT} = 0.1\%$ , $I_{OUT} = 10\text{mA}$			0.2	0.4	
Quiescent Supply Current	$I_{IN}$	$T_A = +25^\circ\text{C}$			40	60	$\mu\text{A}$
		$T_A = -40^\circ\text{C}$ to $+125^\circ\text{C}$				85	
Output Short-Circuit Current	$I_{SC}$	Short to GND: $V_{OUT} = 0V$			90		mA
		Short to $V_{IN}$ : $V_{OUT} = V_{IN}$			-2		
Output Voltage Noise	$e_n$	$0.1\text{Hz} \leq f \leq 10\text{Hz}$			16		$\mu\text{V}_{P-P}$
		$10\text{Hz} \leq f \leq 1\text{kHz}$			12		$\mu\text{V}_{RMS}$
Turn-On Settling Time	$t_{ON}$	$V_{OUT}$ settles to $\pm 0.01\%$ of final value			500		$\mu\text{s}$
Thermal Hysteresis (Note 3)					120		ppm
Long-Term Stability		$\Delta t = 1000$ hours	SO		40		ppm
			$\mu\text{MAX}$		145		

# 3ppm/°C, Low-Power, Low-Dropout Voltage Reference

**MAX6133**

## ELECTRICAL CHARACTERISTICS—MAX6133\_30 (V<sub>OUT</sub> = 3.0000V)

(V<sub>IN</sub> = 5V, C<sub>LOAD</sub> = 0.1μF, I<sub>OUT</sub> = 0, T<sub>A</sub> = T<sub>MIN</sub> to T<sub>MAX</sub>. Typical values are at T<sub>A</sub> = +25°C, unless otherwise noted.)

PARAMETER	SYMBOL	CONDITIONS		MIN	TYP	MAX	UNITS
Output Voltage	V <sub>OUT</sub>	T <sub>A</sub> = +25°C	A grade SO	2.9988	3.0000	3.0012	V
			B grade SO	2.9976	3.0000	3.0024	
			μMAX	2.9982	3.0000	3.0018	
Output Voltage Accuracy		T <sub>A</sub> = +25°C	A grade SO	-0.04		+0.04	%
			B grade SO	-0.08		+0.08	
			μMAX	-0.06		+0.06	
Output Voltage Temperature Coefficient (Note 1)	TCV <sub>OUT</sub>	A grade SO	T <sub>A</sub> = -40°C to +85°C		1	3	ppm/°C
			T <sub>A</sub> = -40°C to +125°C		4	7	
		B grade SO	T <sub>A</sub> = -40°C to +85°C		3	5	
			T <sub>A</sub> = -40°C to +125°C		5	10	
		μMAX	T <sub>A</sub> = -40°C to +85°C		1	5	
			T <sub>A</sub> = -40°C to +125°C		2	7	
Input Voltage Range	V <sub>IN</sub>	Inferred from line regulation		3.2		12.6	V
Line Regulation	ΔV <sub>OUT</sub> /ΔV <sub>IN</sub>	3.2V ≤ V <sub>IN</sub> ≤ 12.6V			2	30	μV/V
Load Regulation	ΔV <sub>OUT</sub> /ΔI <sub>OUT</sub>	-100μA ≤ I <sub>OUT</sub> ≤ 15mA			0.003	0.06	mV/mA
Dropout Voltage (Note 2)	V <sub>DO</sub>	ΔV <sub>OUT</sub> = 0.1%, I <sub>OUT</sub> = 1mA			0.01	0.2	V
		ΔV <sub>OUT</sub> = 0.1%, I <sub>OUT</sub> = 10mA			0.2	0.4	
Quiescent Supply Current	I <sub>IN</sub>	T <sub>A</sub> = +25°C			40	60	μA
		T <sub>A</sub> = -40°C to +125°C				85	
Output Short-Circuit Current	I <sub>SC</sub>	Short to GND: V <sub>OUT</sub> = 0V			90		mA
		Short to V <sub>IN</sub> : V <sub>OUT</sub> = V <sub>IN</sub>			-2		
Output Voltage Noise	e <sub>n</sub>	0.1Hz ≤ f ≤ 10Hz			24		μV <sub>P-P</sub>
		10Hz ≤ f ≤ 1kHz			15		μV <sub>RMS</sub>
Turn-On Settling Time	t <sub>ON</sub>	V <sub>OUT</sub> settles to ±0.01% of final value			600		μs
Thermal Hysteresis (Note 3)					120		ppm
Long-Term Stability		Δt = 1000 hours	SO		40		ppm
			μMAX		145		

# 3ppm/°C, Low-Power, Low-Dropout Voltage Reference

## ELECTRICAL CHARACTERISTICS—MAX6133\_41 (V<sub>OUT</sub> = 4.096V)

(V<sub>IN</sub> = 5V, C<sub>LOAD</sub> = 0.1μF, I<sub>OUT</sub> = 0, T<sub>A</sub> = T<sub>MIN</sub> to T<sub>MAX</sub>. Typical values are at T<sub>A</sub> = +25°C, unless otherwise noted.)

PARAMETER	SYMBOL	CONDITIONS		MIN	TYP	MAX	UNITS
Output Voltage	V <sub>OUT</sub>	T <sub>A</sub> = +25°C	A grade SO	4.0943	4.0960	4.0977	V
			B grade SO	4.0927	4.0960	4.0993	
			μMAX	4.0935	4.0960	4.0985	
Output Voltage Accuracy		T <sub>A</sub> = +25°C	A grade SO	-0.04		+0.04	%
			B grade SO	-0.08		+0.08	
			μMAX	-0.06		+0.06	
Output Voltage Temperature Coefficient (Note 1)	TCV <sub>OUT</sub>	A grade SO	T <sub>A</sub> = -40°C to +85°C		1	3	ppm/°C
			T <sub>A</sub> = -40°C to +125°C		4	7	
		B grade SO	T <sub>A</sub> = -40°C to +85°C		3	5	
			T <sub>A</sub> = -40°C to +125°C		5	10	
		μMAX	T <sub>A</sub> = -40°C to +85°C		1	5	
			T <sub>A</sub> = -40°C to +125°C		2	7	
Input Voltage Range	V <sub>IN</sub>	Inferred from line regulation		4.2		12.6	V
Line Regulation	ΔV <sub>OUT</sub> /ΔV <sub>IN</sub>	4.2V ≤ V <sub>IN</sub> ≤ 12.6V			2	40	μV/V
Load Regulation	ΔV <sub>OUT</sub> /ΔI <sub>OUT</sub>	-100μA ≤ I <sub>OUT</sub> ≤ 15mA			0.003	0.08	mV/mA
Dropout Voltage (Note 2)	V <sub>DO</sub>	ΔV <sub>OUT</sub> = 0.1%, I <sub>OUT</sub> = 1mA			0.01	0.2	V
		ΔV <sub>OUT</sub> = 0.1%, I <sub>OUT</sub> = 10mA			0.2	0.4	
Quiescent Supply Current	I <sub>IN</sub>	T <sub>A</sub> = +25°C			45	65	μA
		T <sub>A</sub> = -40°C to +125°C				85	
Output Short-Circuit Current	I <sub>SC</sub>	Short to GND: V <sub>OUT</sub> = 0V			90		mA
		Short to V <sub>IN</sub> : V <sub>OUT</sub> = V <sub>IN</sub>			-2		
Output Voltage Noise	e <sub>n</sub>	0.1Hz ≤ f ≤ 10Hz			32		μV <sub>P-P</sub>
		10Hz ≤ f ≤ 1kHz			22		μV <sub>RMS</sub>
Turn-On Settling Time	t <sub>ON</sub>	V <sub>OUT</sub> settles to ±0.01% of final value			800		μs
Thermal Hysteresis (Note 3)					120		ppm
Long-Term Stability		Δt = 1000 hours	SO		40		ppm
			μMAX		145		

# 3ppm/°C, Low-Power, Low-Dropout Voltage Reference

MAX6133

## ELECTRICAL CHARACTERISTICS—MAX6133\_50 (V<sub>OUT</sub> = 5.000V)

(V<sub>IN</sub> = 5.5V, C<sub>LOAD</sub> = 0.1μF, I<sub>OUT</sub> = 0, T<sub>A</sub> = T<sub>MIN</sub> to T<sub>MAX</sub>. Typical values are at T<sub>A</sub> = +25°C, unless otherwise noted.)

PARAMETER	SYMBOL	CONDITIONS		MIN	TYP	MAX	UNITS
Output Voltage	V <sub>OUT</sub>	T <sub>A</sub> = +25°C	A grade SO	4.9980	5.0000	5.0020	V
			B grade SO	4.9960	5.0000	5.0040	
			μMAX	4.9970	5.0000	5.0030	
Output Voltage Accuracy		T <sub>A</sub> = +25°C	A grade SO	-0.04		+0.04	%
			B grade SO	-0.08		+0.08	
			μMAX	-0.06		+0.06	
Output Voltage Temperature Coefficient (Note 1)	TCV <sub>OUT</sub>	A grade SO	T <sub>A</sub> = -40°C to +85°C		1	3	ppm/°C
			T <sub>A</sub> = -40°C to +125°C		4	7	
		B grade SO	T <sub>A</sub> = -40°C to +85°C		3	5	
			T <sub>A</sub> = -40°C to +125°C		5	10	
		μMAX	T <sub>A</sub> = -40°C to +85°C		1	5	
			T <sub>A</sub> = -40°C to +125°C		2	7	
Input Voltage Range	V <sub>IN</sub>	Inferred from line regulation		5.2		12.6	V
Line Regulation	ΔV <sub>OUT</sub> /ΔV <sub>IN</sub>	5.2V ≤ V <sub>IN</sub> ≤ 12.6V			2	50	μV/V
Load Regulation	ΔV <sub>OUT</sub> /ΔI <sub>OUT</sub>	-100μA ≤ I <sub>OUT</sub> ≤ 15mA			0.01	0.10	mV/mA
Dropout Voltage (Note 2)	V <sub>DO</sub>	ΔV <sub>OUT</sub> = 0.1%, I <sub>OUT</sub> = 1mA			0.02	0.2	V
		ΔV <sub>OUT</sub> = 0.1%, I <sub>OUT</sub> = 10mA			0.2	0.4	
Quiescent Supply Current	I <sub>IN</sub>	T <sub>A</sub> = +25°C			40	60	μA
		T <sub>A</sub> = -40°C to +125°C				85	
Output Short-Circuit Current	I <sub>SC</sub>	Short to GND: V <sub>OUT</sub> = 0V			90		mA
		Short to V <sub>IN</sub> : V <sub>OUT</sub> = V <sub>IN</sub>			-2		
Output Voltage Noise	e <sub>n</sub>	0.1Hz ≤ f ≤ 10Hz			40		μV <sub>P-P</sub>
		10Hz ≤ f ≤ 1kHz			26		μV <sub>RMS</sub>
Turn-On Settling Time	t <sub>ON</sub>	V <sub>OUT</sub> settles to ±0.01% of final value			1000		μs
Thermal Hysteresis (Note 3)					120		ppm
Long-Term Stability		Δt = 1000 hours	SO		40		ppm
			μMAX		145		

**Note 1:** The MAX6133 is 100% drift-tested for T<sub>A</sub> = T<sub>MIN</sub> to T<sub>MAX</sub>, as specified.

**Note 2:** Dropout Voltage is the minimum voltage at which V<sub>OUT</sub> changes ≤ 0.1% from V<sub>OUT</sub> at V<sub>IN</sub> = 5V (V<sub>IN</sub> = 5.5V for V<sub>OUT</sub> = 5V).

**Note 3:** Thermal Hysteresis is defined as the change in the initial +25°C output voltage after cycling the device from T<sub>MAX</sub> to T<sub>MIN</sub>.

# 3ppm/°C, Low-Power, Low-Dropout Voltage Reference

## Typical Operating Characteristics

( $V_{IN} = 5V$ ,  $I_{OUT} = 0$ ,  $T_A = +25^\circ C$ , unless otherwise noted.) (Note 4)

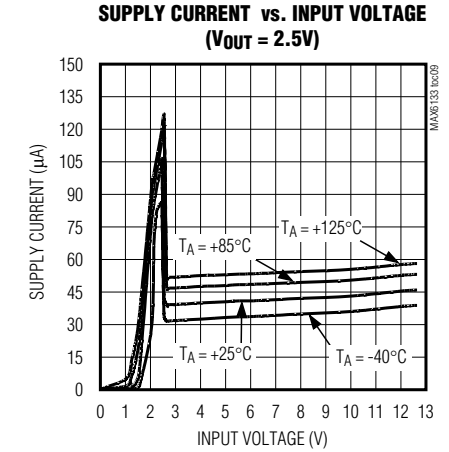
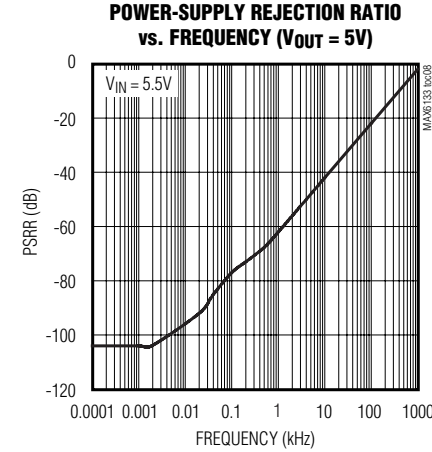
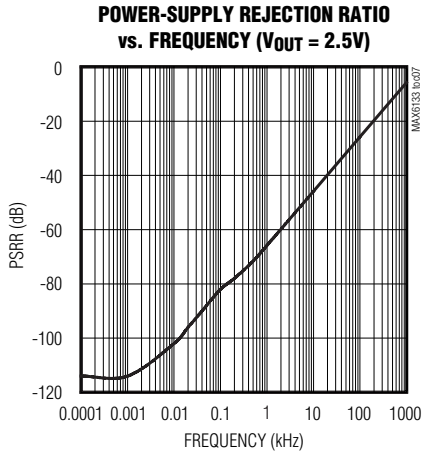
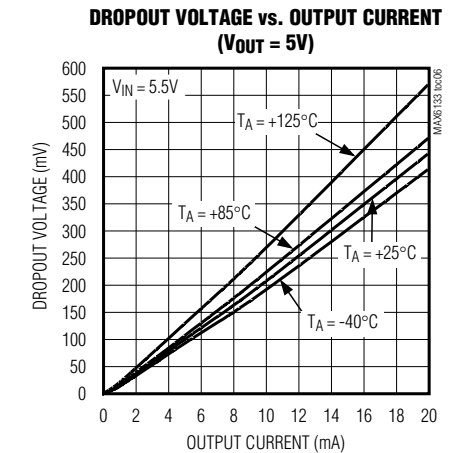
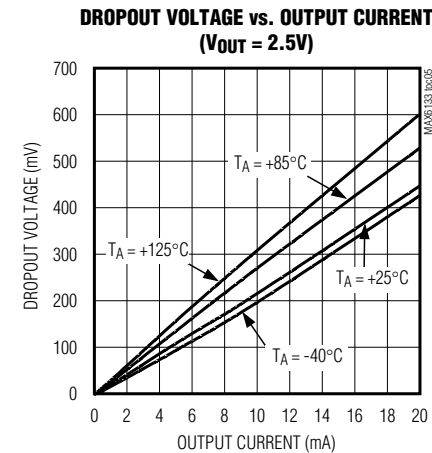
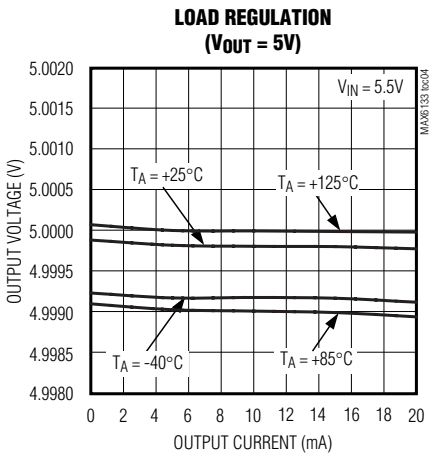
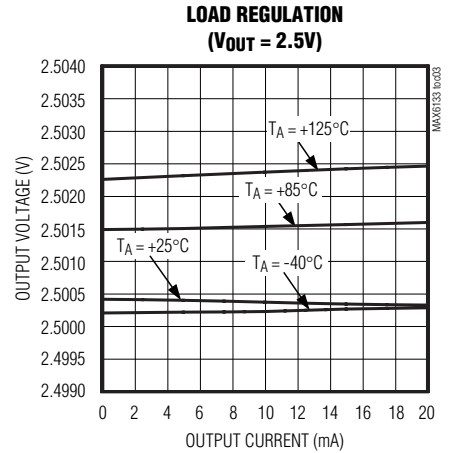
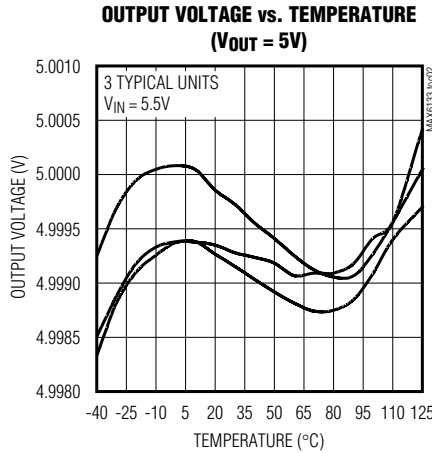
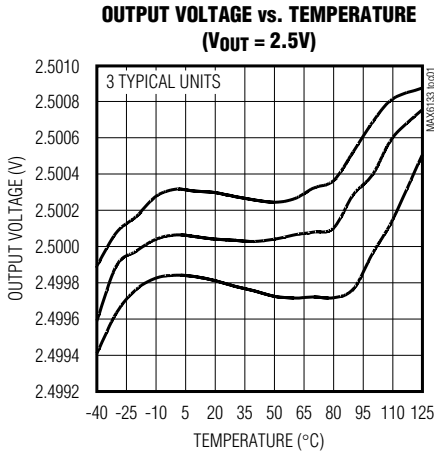

# 3ppm/°C, Low-Power, Low-Dropout Voltage Reference

MAX6133

## Typical Operating Characteristics (continued)

( $V_{IN} = 5V$ ,  $I_{OUT} = 0$ ,  $T_A = +25^\circ C$ , unless otherwise noted.) (Note 4)

**SUPPLY CURRENT vs. INPUT VOLTAGE**  
( $V_{OUT} = 5V$ )

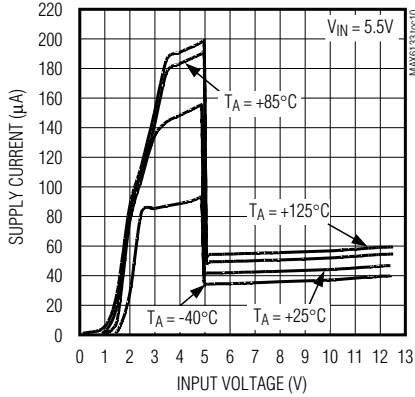

**0.1Hz TO 10Hz OUTPUT NOISE**  
( $V_{OUT} = 2.5V$ )

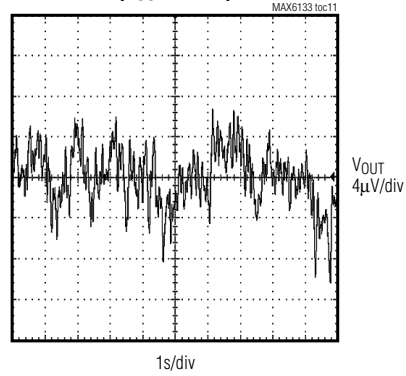

**0.1Hz TO 10Hz OUTPUT NOISE**  
( $V_{OUT} = 5V$ )

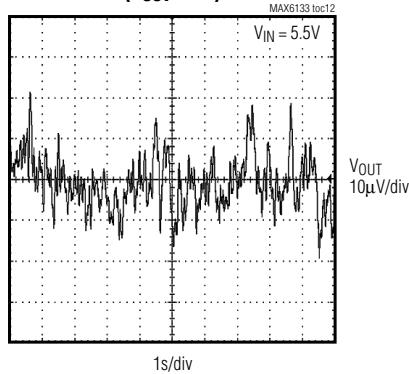

**LOAD TRANSIENT**  
( $V_{OUT} = 2.5V$ )

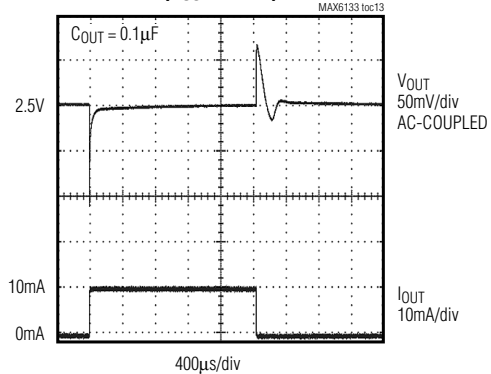

**LOAD TRANSIENT**  
( $V_{OUT} = 2.5V$ )

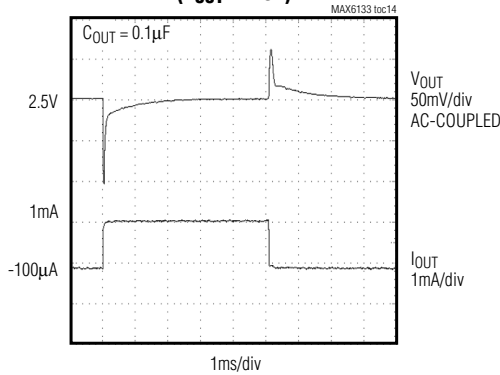

**LOAD TRANSIENT**  
( $V_{OUT} = 2.5V$ )

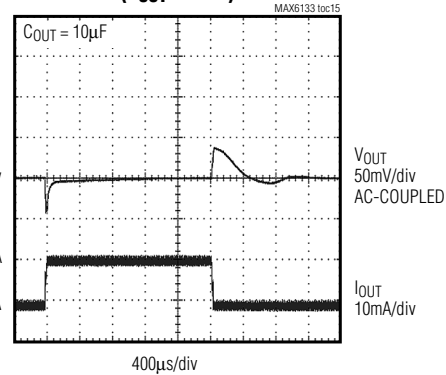

# 3ppm/°C, Low-Power, Low-Dropout Voltage Reference

## Typical Operating Characteristics (continued)

( $V_{IN} = 5V$ ,  $I_{OUT} = 0$ ,  $T_A = +25^\circ C$ , unless otherwise noted.) (Note 4)

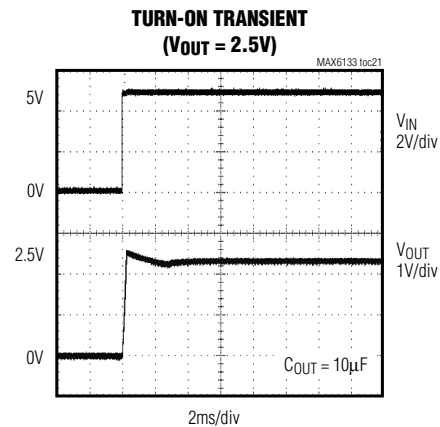
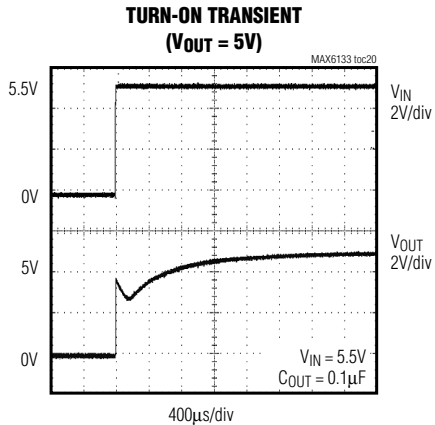
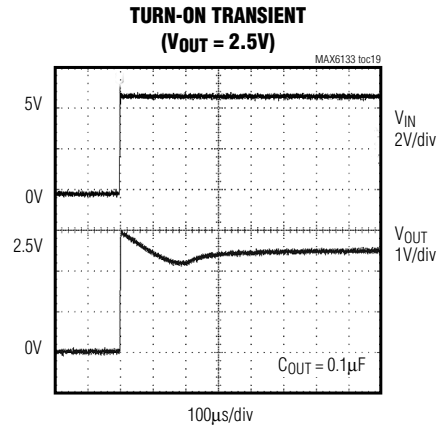
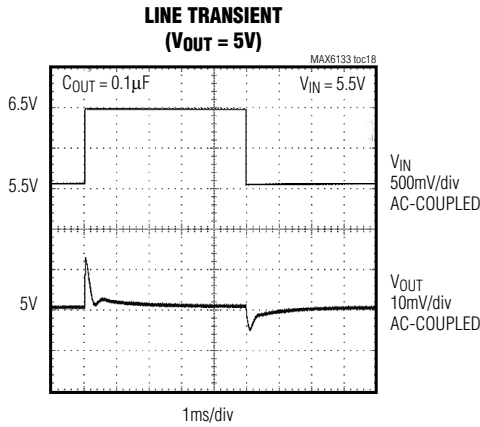
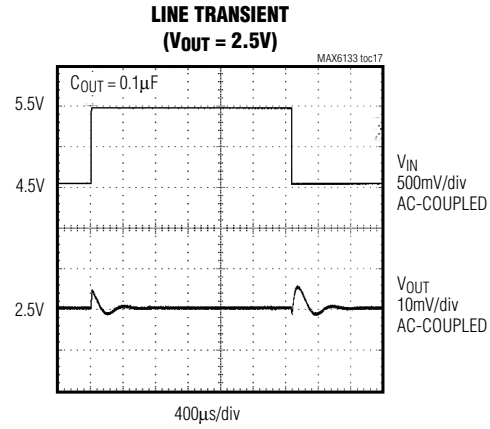
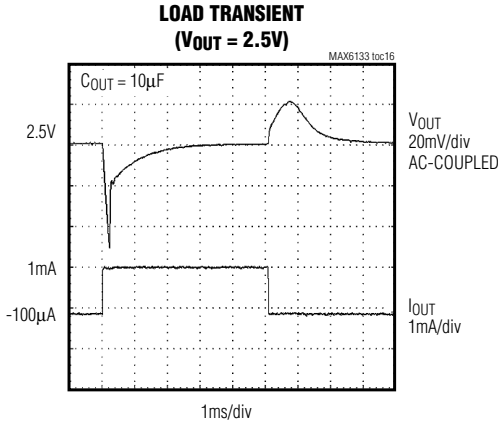



# 3ppm/°C, Low-Power, Low-Dropout Voltage Reference

MAX6133

## Typical Operating Characteristics (continued)

( $V_{IN} = 5V$ ,  $I_{OUT} = 0$ ,  $T_A = +25^\circ C$ , unless otherwise noted.) (Note 4)

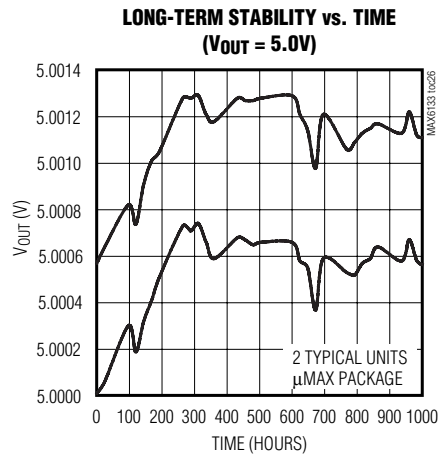
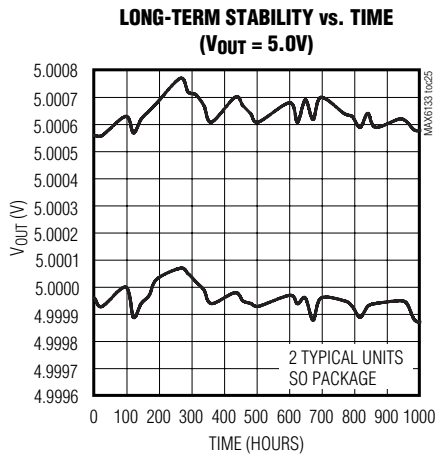
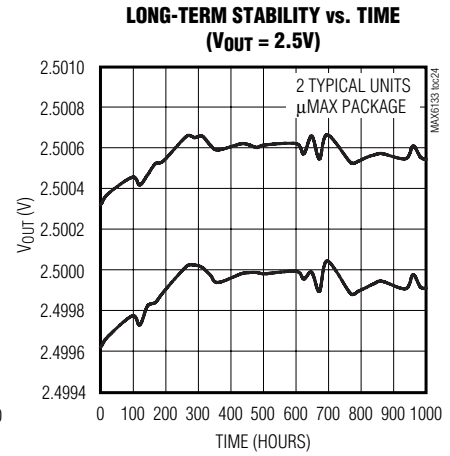
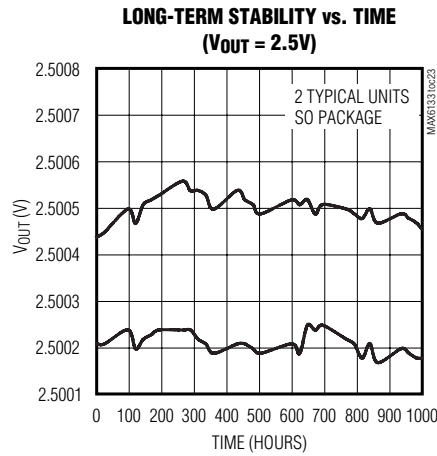
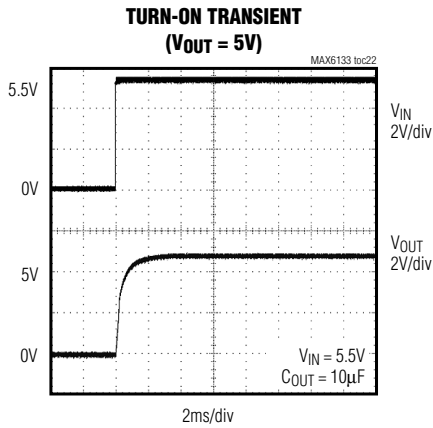

**Note 4:** Many of the MAX6133 *Typical Operating Characteristics* are extremely similar. The extremes of these characteristics are found in the MAX6133 (2.5V output) and the MAX6133 (5V output). The *Typical Operating Characteristics* of the remainder of the MAX6133 family typically lie between these two extremes and can be estimated based on their output voltages.

# 3ppm/°C, Low-Power, Low-Dropout Voltage Reference

## Pin Description

PIN	NAME	FUNCTION
1, 3, 7	N.C.	No Connection. Not connected internally. Leave unconnected or connect to GND.
2	IN	Positive Power-Supply Input
4	GND	Ground
5, 8	I.C.	Internally Connected. Do not connect externally.
6	OUT	Reference Output Voltage. Connect a 0.1μF minimum capacitor to GND.

## Applications Information

### Bypassing/Load Capacitance

For the best line-transient performance, decouple the input with a 0.1μF ceramic capacitor as shown in the *Typical Operating Circuit*. Place the capacitor as close to IN as possible. When transient performance is less important, no capacitor is necessary. The MAX6133 family requires a minimum output capacitance of 0.1μF for stability and is stable with capacitive loads (including the bypass capacitance) of up to 100μF. In applications where the load or the supply can experience step changes, a larger output capacitor reduces the amount of overshoot (undershoot) and improves the circuit's transient response. Place output capacitors as close to the device as possible.

### Supply Current

The quiescent supply current of the MAX6133 series reference is typically 40μA and is virtually independent of the supply voltage. In the MAX6133 family, the load current is drawn from the input only when required, so supply current is not wasted and efficiency is maximized at all input voltages. This improved efficiency reduces power dissipation and extends battery life. When the supply voltage is below the minimum-specified input voltage (as during turn-on), the devices can draw up to 150μA beyond the nominal supply current. The input voltage source must be capable of providing this current to ensure reliable turn-on.

### Thermal Hysteresis

Thermal hysteresis is the change in the output voltage at  $T_A = +25^\circ\text{C}$  before and after the device is cycled over its entire operating temperature range. Hysteresis is caused by differential package stress appearing across the bandgap core transistors. The typical thermal hysteresis value is 120ppm for both SO and μMAX packages.

### Turn-On Time

These devices typically turn on and settle to within 0.01% of their final value in  $<1\text{ms}$ . The turn-on time can increase up to 2ms with the device operating at the minimum dropout voltage and the maximum load.

### Low-Power, 14-Bit DAC with MAX6133 as a Reference

Figure 1 shows a typical application circuit for the MAX6133 providing both the power supply and precision reference voltage for a 14-bit high-resolution, serial-input, voltage-output digital-to-analog converter. The MAX6133 with a 2.5V output provides the reference voltage for the DAC.



Figure 1. 14-Bit High-Resolution DAC and Positive Reference From a Single 3V Supply

# 3ppm/°C, Low-Power, Low-Dropout Voltage Reference

**MAX6133**

## Negative Low-Power Voltage Reference

As shown in Figure 2, the MAX6133 can be used to develop a negative voltage reference using the MAX400, a rail-to-rail op-amp with low power, low noise, and low offset. The circuit only provides a good negative reference and is ideal for space- and cost-sensitive applications since it does not use resistors.



Figure 2. Negative Low-Power Voltage Reference

## Temperature Coefficient vs. Operating Temperature Range for a 1LSB Maximum Error

In a data converter application, the converter's reference voltage must stay within a certain limit to keep the error in the data converter smaller than the resolution limit through the operating temperature range. Figure 3 shows the maximum allowable reference-voltage temperature coefficient that keeps the conversion error to less than 1LSB. This is a function of the operating temperature range ( $T_{MAX} - T_{MIN}$ ) with the converter resolution as a parameter. The graph assumes the reference-voltage temperature coefficient as the only parameter affecting accuracy. In reality, the absolute static accuracy of a data converter is dependent on the combination of many parameters such as integral non-linearity, differential nonlinearity, offset error, gain error, as well as voltage reference changes.

## Chip Information

TRANSISTOR COUNT: 656

PROCESS: BiCMOS



Figure 3. Temperature Coefficient vs. Operating Temperature Range for a 1LSB Maximum Error

# 3ppm/°C, Low-Power, Low-Dropout Voltage Reference

## Package Information

(The package drawing(s) in this data sheet may not reflect the most current specifications. For the latest package outline information, go to [www.maxim-ic.com/packages](http://www.maxim-ic.com/packages).)

SOICN .EPS

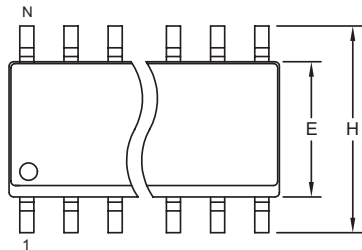

TOP VIEW

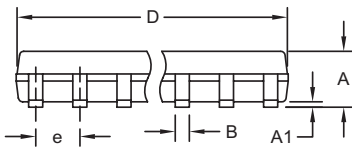

FRONT VIEW

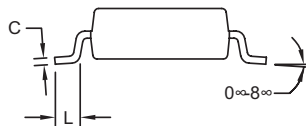

SIDE VIEW

DIM	INCHES		MILLIMETERS	
	MIN	MAX	MIN	MAX
A	0.053	0.069	1.35	1.75
A1	0.004	0.010	0.10	0.25
B	0.014	0.019	0.35	0.49
C	0.007	0.010	0.19	0.25
e	0.050 BSC		1.27 BSC	
E	0.150	0.157	3.80	4.00
H	0.228	0.244	5.80	6.20
L	0.016	0.050	0.40	1.27

VARIATIONS:

DIM	INCHES		MILLIMETERS		N	MS012
	MIN	MAX	MIN	MAX		
D	0.189	0.197	4.80	5.00	8	AA
D	0.337	0.344	8.55	8.75	14	AB
D	0.386	0.394	9.80	10.00	16	AC

NOTES:

1. D&E DO NOT INCLUDE MOLD FLASH.
2. MOLD FLASH OR PROTRUSIONS NOT TO EXCEED 0.15mm (.006").
3. LEADS TO BE COPLANAR WITHIN 0.10mm (.004").
4. CONTROLLING DIMENSION: MILLIMETERS.
5. MEETS JEDEC MS012.
6. N = NUMBER OF PINS.

<small>PROPRIETARY INFORMATION</small>	
<small>TITLE:</small> PACKAGE OUTLINE, .150" SOIC	
<small>APPROVAL</small>	<small>DOCUMENT CONTROL NO.</small> 21-0041
<small>REV.</small> B	<small>1/1</small>

# 3ppm/°C, Low-Power, Low-Dropout Voltage Reference

## Package Information (continued)

(The package drawing(s) in this data sheet may not reflect the most current specifications. For the latest package outline information, go to [www.maxim-ic.com/packages](http://www.maxim-ic.com/packages).)

**MAX6133**

8LUMAXD.EPS

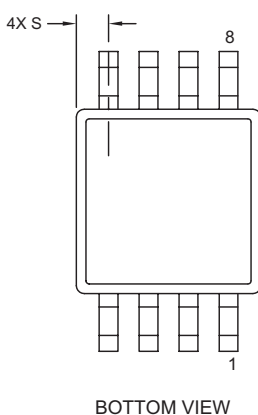
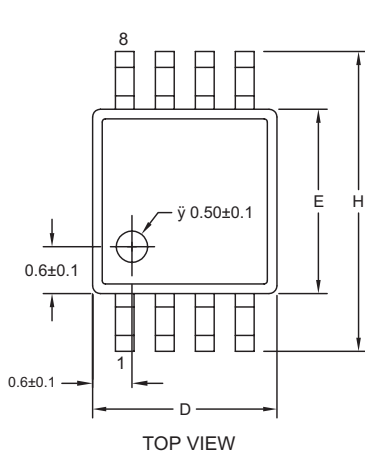

DIM	INCHES		MILLIMETERS	
	MIN	MAX	MIN	MAX
A	-	0.043	-	1.10
A1	0.002	0.006	0.05	0.15
A2	0.030	0.037	0.75	0.95
b	0.010	0.014	0.25	0.36
c	0.005	0.007	0.13	0.18
D	0.116	0.120	2.95	3.05
e	0.0256 BSC		0.65 BSC	
E	0.116	0.120	2.95	3.05
H	0.188	0.198	4.78	5.03
L	0.016	0.026	0.41	0.66
α	0°	6°	0°	6°
S	0.0207 BSC		0.5250 BSC	

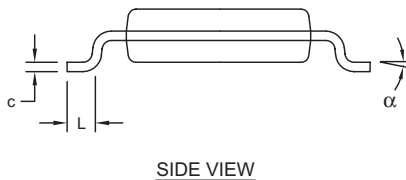
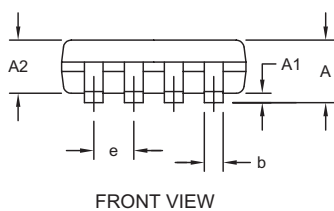

- NOTES:
1. D&E DO NOT INCLUDE MOLD FLASH.
  2. MOLD FLASH OR PROTRUSIONS NOT TO EXCEED 0.15MM (.006").
  3. CONTROLLING DIMENSION: MILLIMETERS.
  4. MEETS JEDEC MO-187C-AA.

<small>PROPRIETARY INFORMATION</small>	
<small>TITLE:</small> <b>PACKAGE OUTLINE, 8L uMAX/uSOP</b>	
<small>APPROVAL</small>	<small>DOCUMENT CONTROL NO.</small> <b>21-0036</b>
<small>REV.</small> <b>J</b>	<small>REV.</small> <b>1/1</b>

Maxim cannot assume responsibility for use of any circuitry other than circuitry entirely embodied in a Maxim product. No circuit patent licenses are implied. Maxim reserves the right to change the circuitry and specifications without notice at any time.

**Maxim Integrated Products, 120 San Gabriel Drive, Sunnyvale, CA 94086 408-737-7600** \_\_\_\_\_ **13**



Компания «ЭлектроПласт» предлагает заключение долгосрочных отношений при поставках импортных электронных компонентов на взаимовыгодных условиях!

Наши преимущества:

- Оперативные поставки широкого спектра электронных компонентов отечественного и импортного производства напрямую от производителей и с крупнейших мировых складов;
- Поставка более 17-ти миллионов наименований электронных компонентов;
- Поставка сложных, дефицитных, либо снятых с производства позиций;
- Оперативные сроки поставки под заказ (от 5 рабочих дней);
- Экспресс доставка в любую точку России;
- Техническая поддержка проекта, помощь в подборе аналогов, поставка прототипов;
- Система менеджмента качества сертифицирована по Международному стандарту ISO 9001;
- Лицензия ФСБ на осуществление работ с использованием сведений, составляющих государственную тайну;
- Поставка специализированных компонентов (Xilinx, Altera, Analog Devices, Intersil, Interpoint, Microsemi, Aeroflex, Peregrine, Syfer, Eurofarad, Texas Instrument, Miteq, Cobham, E2V, MA-COM, Hittite, Mini-Circuits, General Dynamics и др.);

Помимо этого, одним из направлений компании «ЭлектроПласт» является направление «Источники питания». Мы предлагаем Вам помощь Конструкторского отдела:

- Подбор оптимального решения, техническое обоснование при выборе компонента;
- Подбор аналогов;
- Консультации по применению компонента;
- Поставка образцов и прототипов;
- Техническая поддержка проекта;
- Защита от снятия компонента с производства.



#### Как с нами связаться

**Телефон:** 8 (812) 309 58 32 (многоканальный)

**Факс:** 8 (812) 320-02-42

**Электронная почта:** [org@eplast1.ru](mailto:org@eplast1.ru)

**Адрес:** 198099, г. Санкт-Петербург, ул. Калинина, дом 2, корпус 4, литера А.