

power light source

LUXEON® Rebel

Introduction

LUXEON® Rebel is an ultra-compact, surface-mount, high-power LED that delivers elevated standards for light output, flux density and manufacturability. Offering industry-leading flux density, lumens per package and power handling capabilities, LUXEON Rebel enables you to create never before possible lighting applications and:

- ♦ deliver more useable light and higher flux density
- ♦ optimize applications to reduce size and cost
- ♦ tightly pack the LEDs for color mixing applications
- ♦ engineer more robust applications
- ♦ utilize standard FR4 PCB technology
- ♦ simplify manufacturing through the use of surface mount technology.



LUXEON Rebel Technology Leadership

- ♦ 150°C Junction Temperature
- ♦ Industry leading lumen performance, > 100 lumens in cool white at 350mA
- ♦ 350mA — 1000mA drive current
- ♦ High efficacy, flux density and lumens per package
- ♦ Industry best moisture sensitivity level—JEDEC Level 1 unlimited floor life - no need for reconditioning
- ♦ Lead-free reflow solder JEDEC 020c compatible
- ♦ RoHS Compliant
- ♦ Autoclave compliant—JESD22 A-102
- ♦ Industry best lumen maintenance—50,000 hours life at 700 mA with 70% lumen maintenance
- ♦ Electrically isolated thermal pad
- ♦ Available in all colors.

Table of Contents

Product Nomenclature	.3
Average Lumen Maintenance Characteristics	.3
Environmental Compliance	.3
Visual Appearance of LUXEON Rebel	.3
Flux Characteristics for LUXEON Rebel	.4
Optical Characteristics	.6
Electrical Characteristics	.7
Absolute Maximum Ratings	.8
JEDEC Moisture Sensitivity	.8
Reflow Soldering Characteristics	.9
Mechanical Dimensions	.10
Pad Configuration	.11
Solder Pad Design	.11
Wavelength Characteristics	.12
Typical Light Output Characteristics over Temperature	.14
Typical Forward Current Characteristics	.15
Typical Relative Luminous Flux	.16
Current Derating Curves	.17
Typical Radiation Patterns	.20
Emitter Pocket Tape Packaging	.23
Emitter Reel Packaging	.24
Product Binning and Labeling	.25
Luminous Flux Bins	.26
Cool-White Bin Structure	.27
Neutral-White Bin Structure	.29
Warm-White Bin Structure	.30
Color Bins	.31
Forward Voltage Bins	.32

Product Nomenclature

LUXEON Rebel is tested and binned at 350mA.

The part number designation is explained as follows:

L X M L - A B C D - E F G H

Where:

- A — designates radiation pattern (value P for Lambertian)
- B — designates color (see LUXEON Rebel Binning and Labelling section)
- C — designates color variant (0 for direct colored variants, C for Cool-White, N for Neutral-White and W for Warm-White)
- D — designates test current (value 1 for 350 mA)
- E — reserved for future product offerings
- FGH — minimum luminous flux (lm) or radiometric power (mW) performance

Therefore products tested and binned at 350 mA follow the part numbering scheme:

L X M L - P x x 1 - x x x x

Average Lumen Maintenance Characteristics

Lifetime for solid-state lighting devices (LEDs) is typically defined in terms of lumen maintenance—the percentage of initial light output remaining after a specified period of time.

Philips Lumileds projects that cool-white, neutral-white, warm-white, green, cyan, blue and royal-blue LUXEON Rebel products will deliver, on average, 70% lumen maintenance (B50, L70) at 50,000 hours of operation at a forward current of 700 mA. This projection is based on constant current operation with junction temperature maintained at or below 135°C.

Philips Lumileds projects that red, red-orange and amber LUXEON Rebel products will deliver, on average, 70% lumen maintenance (B50, L70) at 50,000 hours of operation at a forward current of 350 mA. This projection is based on constant current operation with junction temperature maintained at or below 110°C.

This performance is based on independent test data, Philips Lumileds historical data from tests run on similar material systems, and internal LUXEON reliability testing. Observation of design limits included in this data sheet is required in order to achieve this projected lumen maintenance.

Environmental Compliance

Philips Lumileds is committed to providing environmentally friendly products to the solid-state lighting market. LUXEON Rebel is compliant to the European Union directives on the restriction of hazardous substances in electronic equipment, namely the RoHS directive. Philips Lumileds will not intentionally add the following restricted materials to the LUXEON Rebel: lead, mercury, cadmium, hexavalent chromium, polybrominated biphenyls (PBB) or polybrominated diphenyl ethers (PBDE).

Visual Appearance of LUXEON Rebel

All lighted LUXEON Rebel product will provide comparable Lambertian beam performance, suitable for use with commercially available optical systems. Without power, LED die within different reels may appear visually different. Please contact your Philips Lumileds or Future Electronics representative for further information.

Flux Characteristics for LUXEON Rebel – Thermal Pad Temperature = 25°C

Table 1.

Performance at Test Current				Typical Performance at Indicated Current	
Color	Part Number	Minimum Luminous Flux (lm) or Radiometric Power (mW) Φ_V ^{[1] [3]}	Test Current (mA)	Typical Luminous Flux (lm) or Radiometric Power (mW) Φ_V ^{[2] [3]}	Drive Current (mA)
Cool-White	LXML-PWC1-0040	40	350	80	700
	LXML-PWC1-0050	50	350	95	700
	LXML-PWC1-0070	70	350	130	700
	LXML-PWC1-0080	80	350	145	700
	LXML-PWC1-0090	90	350	160	700
	LXML-PWC1-0100	100	350	180	700
Neutral-White	LXML-PWN1-0040	40	350	80	700
	LXML-PWN1-0050	50	350	95	700
	LXML-PWN1-0070	70	350	130	700
	LXML-PWN1-0080	80	350	145	700
Warm-White	LXML-PWW1-0040	40	350	80	700
	LXML-PWW1-0050	50	350	95	700
	LXML-PWW1-0060	60	350	110	700
Green	LXML-PM01-0040	40	350	80	700
	LXML-PM01-0050	50	350	95	700
	LXML-PM01-0070	70	350	130	700
	LXML-PM01-0080	80	350	145	700
Cyan	LXML-PE01-0030	30	350	65	700
	LXML-PE01-0040	40	350	80	700
	LXML-PE01-0060	60	350	110	700
	LXML-PE01-0070	70	350	130	700
Blue	LXML-PB01-0008	8.2	350	19	700
	LXML-PB01-0010	10.7	350	22	700
	LXML-PB01-0013	13.9	350	27	700
	LXML-PB01-0018	18.1	350	38	700
	LXML-PB01-0023	23.5	350	48	700
Royal-Blue	LXML-PR01-0175	175 mW	350	325 mW	700
	LXML-PR01-0225	225 mW	350	400 mW	700
	LXML-PR01-0275	275 mW	350	525 mW	700

Notes for Table 1:

1. Minimum luminous flux or radiometric power performance guaranteed within published operating conditions. Philips Lumileds maintains a tolerance of $\pm 6.5\%$ on flux and power measurements.
2. Typical luminous flux or radiometric power performance when device is operated within published operating conditions.
3. LUXEON Rebel products with even higher luminous flux and radiometric power levels will become available in the future. Please consult Philips Lumileds or Future Electronics for more information.

Flux Characteristics for LUXEON Rebel Continued Thermal Pad Temperature = 25°C

Table 1. Continued

Performance at Test Current				Typical Performance at Indicated Current	
Color	Part Number	Minimum Luminous Flux (lm) Φ_v ^[1] ^[3]	Test Current (mA)	Typical Luminous Flux (lm) Φ_v ^[2] ^[3]	Drive Current (mA)
Red	LXML-PD01-0030	30	350	65	700
	LXML-PD01-0040	40	350	85	700
Red-Orange	LXML-PH01-0040	40	350	85	700
	LXML-PH01-0050	50	350	100	700
Amber	LXML-PL01-0023	23.5	350	50	700
	LXML-PL01-0030	30.0	350	65	700

Notes for Table 1:

1. Minimum luminous flux or radiometric power performance guaranteed within published operating conditions. Philips Lumileds maintains a tolerance of $\pm 6.5\%$ on flux and power measurements.
2. Typical luminous flux performance is when device is operated within published operating conditions.
3. LUXEON Rebel products with even higher luminous flux and levels will become available in the future. Please consult Philips Lumileds or Future Electronics for more information.

Optical Characteristics

Lambertian LUXEON Rebel at Test Current^[1] Thermal Pad Temperature = 25°C

Table 2.

Color	Dominant Wavelength ^[2] λ_D , Peak Wavelength ^[3] λ_P , or Color Temperature ^[4] CCT			Typical Spectral Half-width ^[6] (nm) $\Delta\lambda_{1/2}$	Typical Temperature Coefficient of Dominant Wavelength (nm/°C) $\Delta\lambda_P / \Delta T_J$	Typical Total Included Angle ^[7] (degrees) $\theta_{0.90V}$	Typical Viewing Angle ^[8] (degrees) $2\theta_{1/2}$
	Min.	Typ.	Max.				
Cool-White	4500 K	6500 K	10,000 K	N/A	N/A	160	140
Neutral-White	3500 K	4100 K	4500 K	N/A	N/A	160	140
Warm-White	2670 K	3100 K	3500 K	N/A	N/A	160	140
Green	520 nm	530 nm	550 nm	30	0.05	160	140
Cyan	490 nm	505 nm	520 nm	30	0.04	160	140
Blue	460 nm	470 nm	490 nm	33	0.05	160	140
Royal-Blue ^[9]	440 nm	455 nm	460 nm	24	0.04	160	140
Red	620.5 nm	627 nm	645 nm	29	0.05	160	140
Red-Orange	613.5 nm	617 nm	620.5 nm	28	0.08	160	140
Amber	584.5 nm	590 nm	597 nm	28	0.10	160	140

Notes for Table 2:

1. Test current is 350 mA for all LXML-Pxx1-0xxx products.
2. Dominant wavelength is derived from the CIE 1931 Chromaticity diagram and represents the perceived color. Philips Lumileds maintains a tolerance of ± 0.5 nm for dominant wavelength measurements.
3. Royal-Blue product is binned by radiometric power and peak wavelength rather than photometric lumens. Philips Lumileds maintains a tolerance of ± 2 nm for peak wavelength measurements.
4. CCT $\pm 5\%$ tester tolerance.
5. Typical CRI (Color Rendering Index) for Cool-White is 70, Neutral-White is 75 and Warm-White is 80.
6. Spectral width at $1/2$ of the peak intensity.
7. Total angle at which 90% of total luminous flux is captured.
8. Viewing angle is the off axis angle from lamp centerline where the luminous intensity is $1/2$ of the peak value.
9. All white, green, cyan, blue and royal-blue products are built with Indium Gallium Nitride (InGaN).
10. All red, red-orange, and amber are built with Aluminum Indium Gallium Phosphide (AlInGaP).
11. Cool-White, Neutral-White, Warm-White, Blue and Royal-Blue power light sources represented here are IEC825 class 2 for eye safety.

Electrical Characteristics

Electrical Characteristics at 350mA for LUXEON Rebel, Part Numbers LXML-Pxx1-0xxx, Thermal Pad Temperature = 25°C

Table 3.

Color	Forward Voltage V_f ^[1]			Typical Dynamic Resistance ^[2] (Ω) R_D	Typical Temperature Coefficient of Forward Voltage ^[3] (mV/°C) $\Delta V_f / \Delta T_J$	Typical Thermal Resistance Junction to Thermal Pad (°C/W) $R\theta_{J-C}$
	Min.	Typ.	Max.			
Cool-White	2.55	3.15	3.99	0.3	-3.0	10
Neutral-White	2.55	3.15	3.99	0.3	-3.0	10
Warm-White	2.55	3.15	3.99	0.3	-3.0	10
Green	2.55	3.15	3.99	0.3	-6.0	10
Cyan	2.55	3.15	3.99	0.3	-3.0	10
Blue	2.55	3.15	3.99	0.2	-3.0	10
Royal-Blue	2.55	3.15	3.99	0.2	-5.0	10
Red	2.31	2.9	3.51	1.65	-3.5	12
Red-Orange	2.31	2.9	3.51	1.5	-3.0	12
Amber	2.31	2.9	3.51	1.3	-2.5	12

Notes for Table 3:

1. Philips Lumileds maintains a tolerance of $\pm 0.06V$ on forward voltage measurements.
2. Dynamic resistance is the inverse of the slope in linear forward voltage model for LEDs. See figures 8 and 9.
3. Measured between $25^\circ C = T_J = 110^\circ C$ at $I_f = 350$ mA.

Typical Electrical Characteristics at 700mA for LUXEON Rebel, Part Numbers LXML-Pxx1-0xxx, Thermal Pad Temperature = 25°C

Table 4.

Color	Typical Forward Voltage V_f (V)
Cool-White	3.40
Neutral-White	3.40
Warm-White	3.40
Green	3.40
Cyan	3.40
Blue	3.40
Royal-Blue	3.40
Red	3.60
Red-Orange	3.60
Amber	3.60

Notes for Table 4:

1. Philips Lumileds maintains a tolerance of $\pm 0.06V$ on forward voltage measurements.
2. Dynamic resistance is the inverse of the slope in linear forward voltage model for LEDs. See figures 8 and 9.
3. Measured between $25^\circ C = T_J = 110^\circ C$ at $I_f = 700$ mA.

Absolute Maximum Ratings

Table 5.

Parameter	Cool-White / Neutral-White / Warm-White / Green / Cyan / Blue / Royal-Blue	Red / Red-Orange / Amber
DC Forward Current (mA)	1000	700
Peak Pulsed Forward Current (mA)	1000	700
Average Forward Current (mA)	1000	700
ESD Sensitivity	< 8000V Human Body Model (HBM) Class 2 JESD22-A114-B < 400V Machine Model (MM) Class 2 JESD22-A115-B	< 8000V Human Body Model (HBM) Class 2 JESD22-A114-B < 400V Machine Model (MM) Class 2 JESD22-A115-B
LED Junction Temperature ⁽¹⁾	150°C	135°C
Operating Case Temperature at 350mA	-40°C - 135°C	-40°C - 120°C
Storage Temperature	-40°C - 135°C	-40°C - 135°C
Soldering Temperature	JEDEC 020c 260°C	JEDEC 020c 260°C
Allowable Reflow Cycles	3	3
Autoclave Conditions	121°C at 2 ATM 100% Relative Humidity for 96 Hours Maximum	
Reverse Voltage (Vr)	See Note 2	See Note 2

Notes for Table 5:

1. Proper current derating must be observed to maintain junction temperature below the maximum.
2. LUXEON Rebel LEDs are not designed to be driven in reverse bias.

JEDEC Moisture Sensitivity

Table 6.

Level	Floor Life		Soak Requirements	
	Time	Conditions	Standard	
			Time (hours)	Conditions
1	unlimited	$\leq 30^{\circ}\text{C}$ / 85% RH	168 + 5/-0	85°C / 85% RH

Reflow Soldering Characteristics

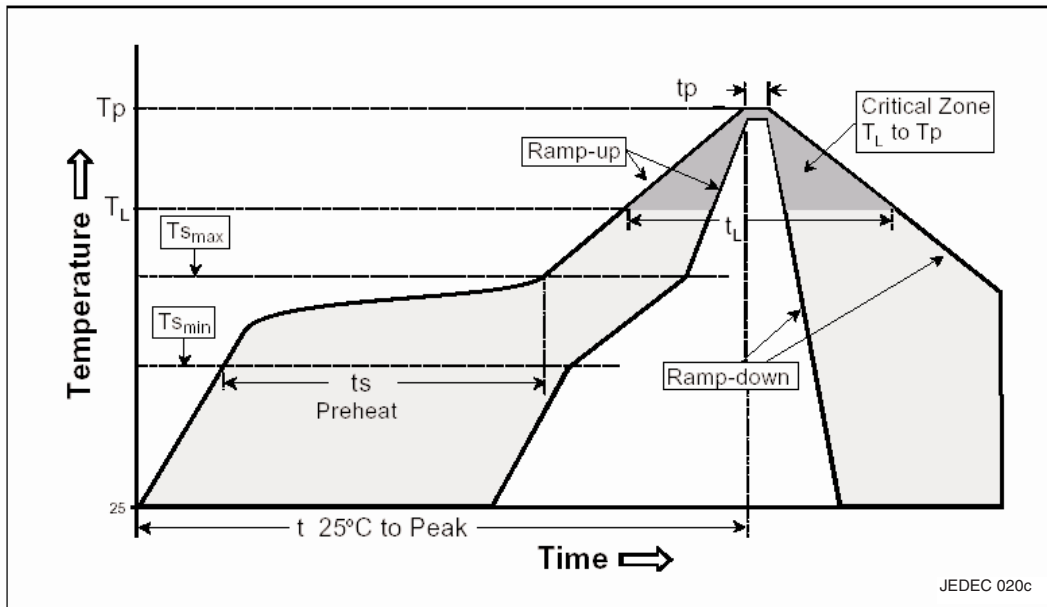

Table 7.

Profile Feature	Lead Free Assembly
Average Ramp-Up Rate ($T_{s_{max}}$ to T_p)	3°C / second max
Preheat Temperature Min ($T_{s_{min}}$)	150°C
Preheat Temperature Max ($T_{s_{max}}$)	200°C
Preheat Time ($t_{s_{min}}$ to $t_{s_{max}}$)	60 - 180 seconds
Time Maintained Above Temperature (T_l)	217°C
Time Maintained Above Time (t_l)	60 - 150 seconds
Peak / Classification Temperature (T_p)	260°C
Time Within 5°C of Actual Peak Temperature (t_p)	20 - 40 seconds
Ramp - Down Rate	6°C / second max
Time 25°C to Peak Temperature	8 minutes max

Notes for Table 7:

1. All temperatures refer to the application Printed Circuit Board (PCB), measured on the surface adjacent to the package body.

Mechanical Dimensions

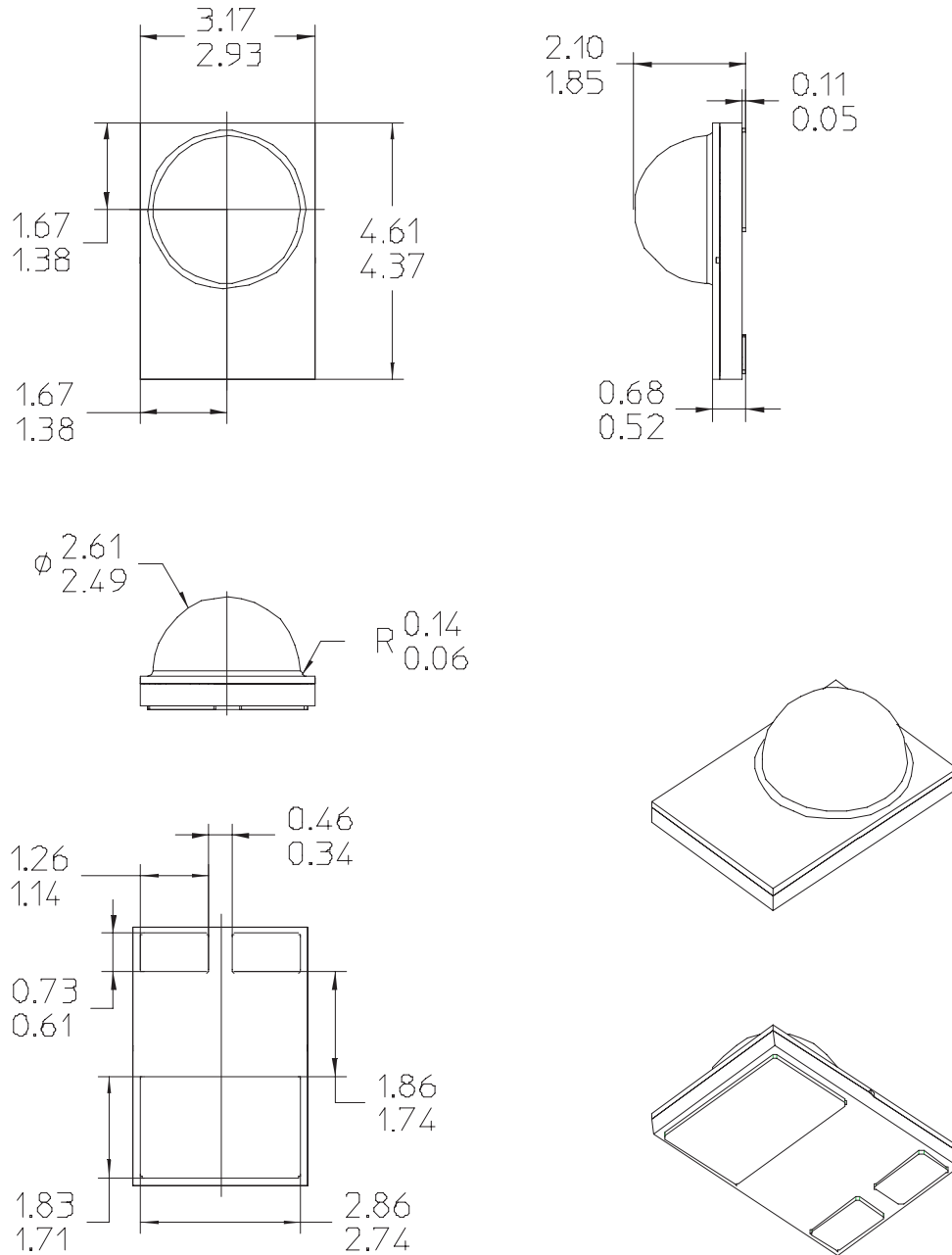

Figure 1. Package Outline Drawing.

Notes for Figure 1:

1. Do not handle the device by the lens—care must be taken to avoid damage to the lens or the interior of the device that can be damaged by excessive force to the lens.
2. Drawings not to scale.
3. All dimensions are in millimeters.
4. The Thermal Pad is electrically isolated from the Anode and Cathode contact pads.

Pad Configuration

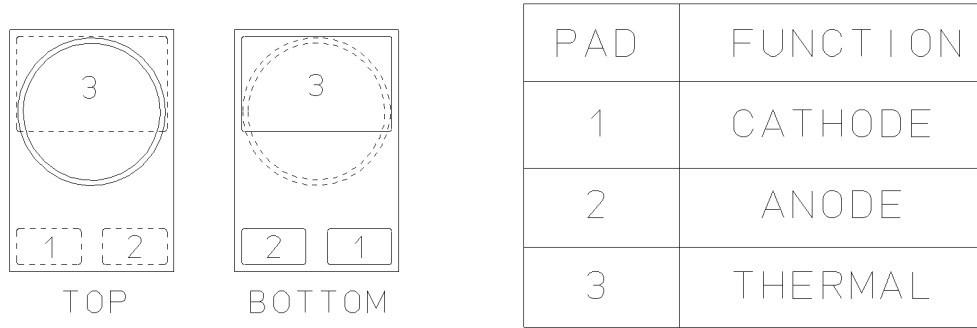

Figure 2. Pad Configuration.

Note for Figure 2:

1. The Thermal Pad is electrically isolated from the Anode and Cathode contact pads.

Solder Pad Design

Note for Figure 3:

The photograph below shows the recommended LUXEON Rebel layout on Printed Circuit Board (PCB). This design easily achieves a thermal resistance of 7K/W.

Application Brief AB32 provides extensive details for this layout. In addition, the .dwg files are available upon request.

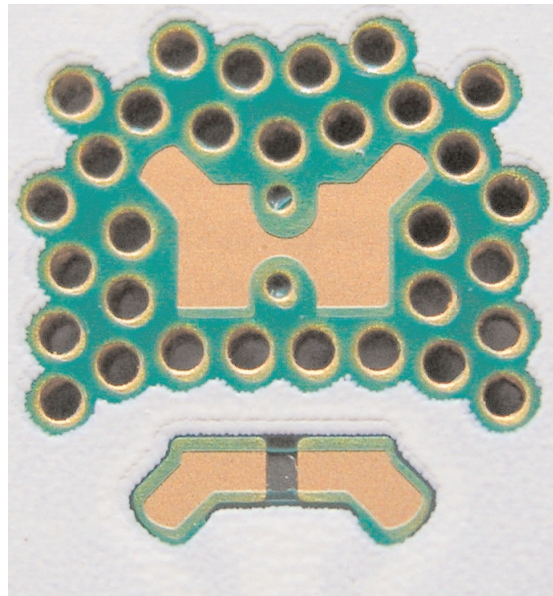

Figure 3. Solder Pad Layout.

Wavelength Characteristics

Green, Cyan, Blue, Royal-Blue, Red, Red-Orange and Amber at Test Current Thermal Pad Temperature, $T_J = 25^\circ\text{C}$

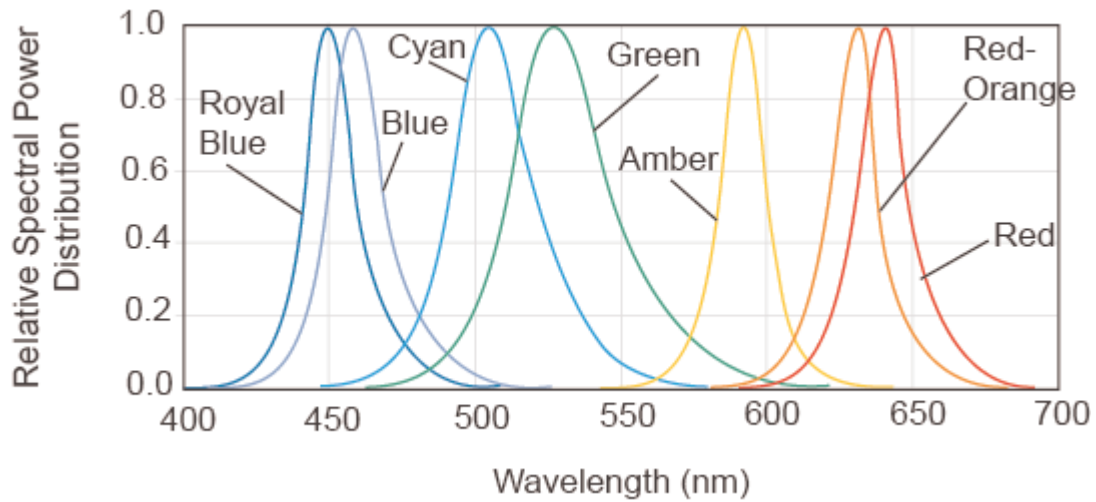

Figure 4. Relative intensity vs. wavelength.

Cool-White at Test Current Thermal Pad Temperature = 25°C

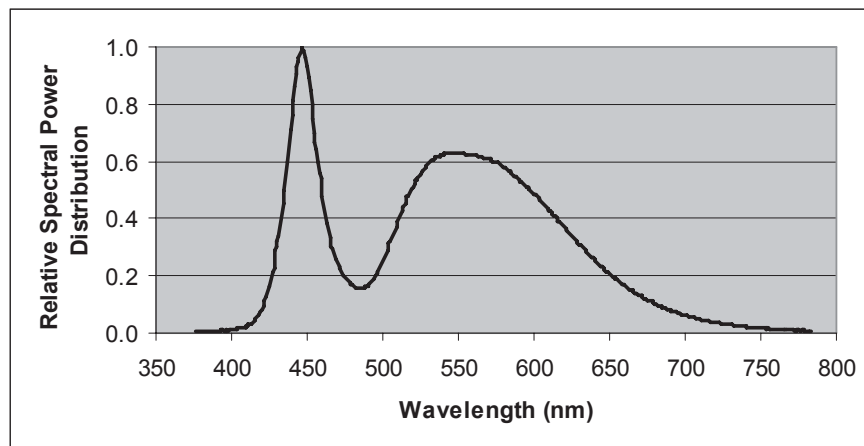

Figure 5a. Cool-White color spectrum of typical CCT part, integrated measurement.

Neutral-White at Test Current Thermal Pad Temperature = 25°C

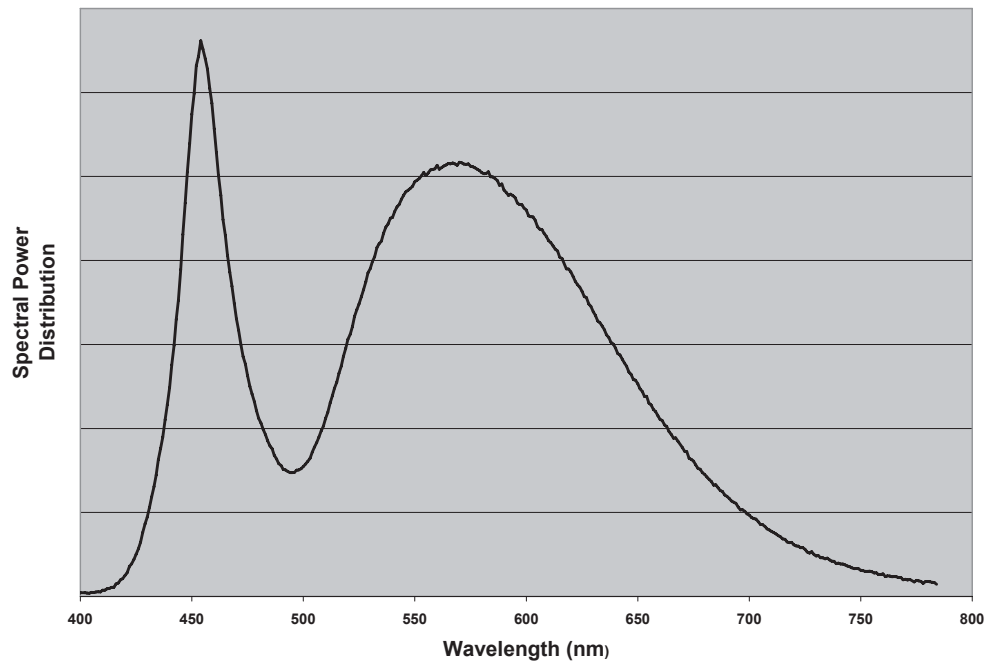

Figure 5b. Neutral-White color spectrum of typical CCT part, integrated measurement.

Warm-White at Test Current Thermal Pad Temperature = 25°C

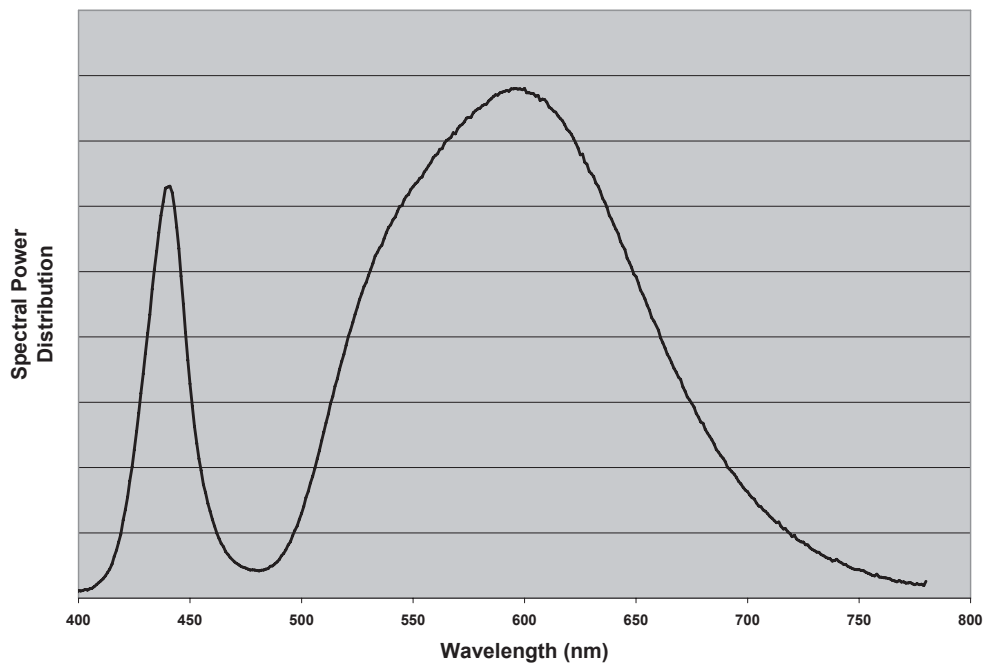

Figure 5c. Warm-White color spectrum of typical CCT part, integrated measurement.

Typical Light Output Characteristics over Temperature

Cool-White, Neutral-White, Warm-White, Green, Cyan, Blue and Royal-Blue at Test Current.

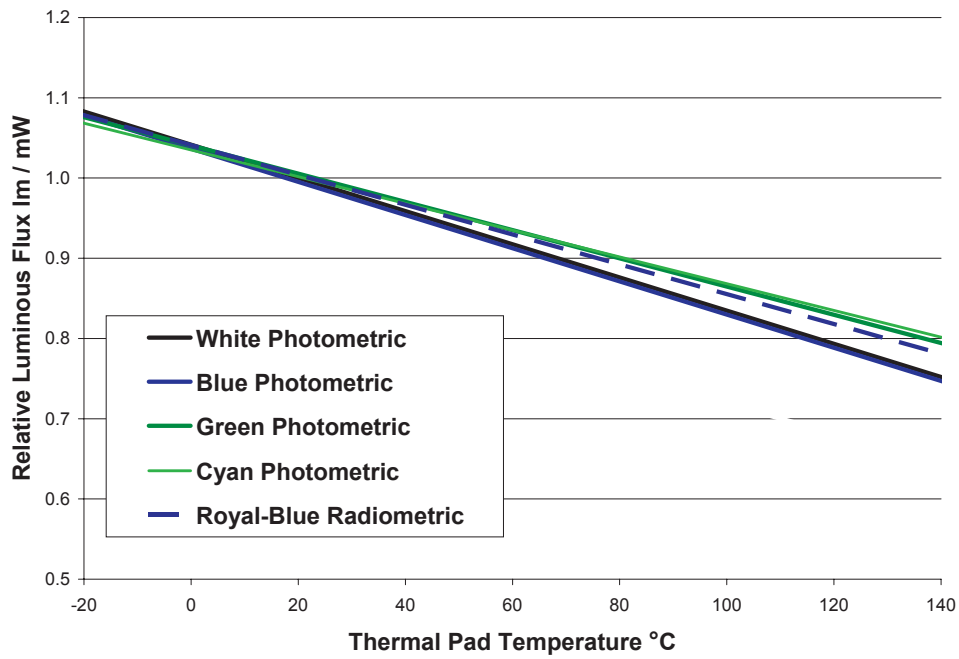

Figure 6. Relative light output vs. Thermal Pad temperature for White, Green, Cyan, Blue and Royal-Blue.

Red, Red-Orange and Amber at Test Current

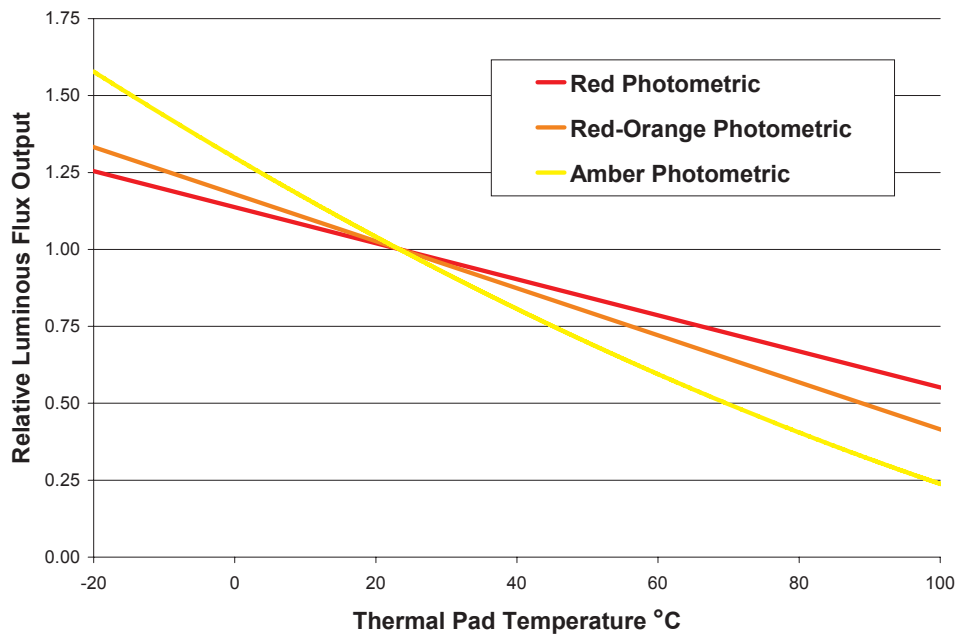

Figure 7. Relative light output vs. Thermal Pad temperature for Red, Red-Orange and Amber.

Typical Forward Current Characteristics

Cool-White, Neutral-White, Warm-White, Green, Cyan, Blue and Royal-Blue, Thermal Pad Temperature = 25°C

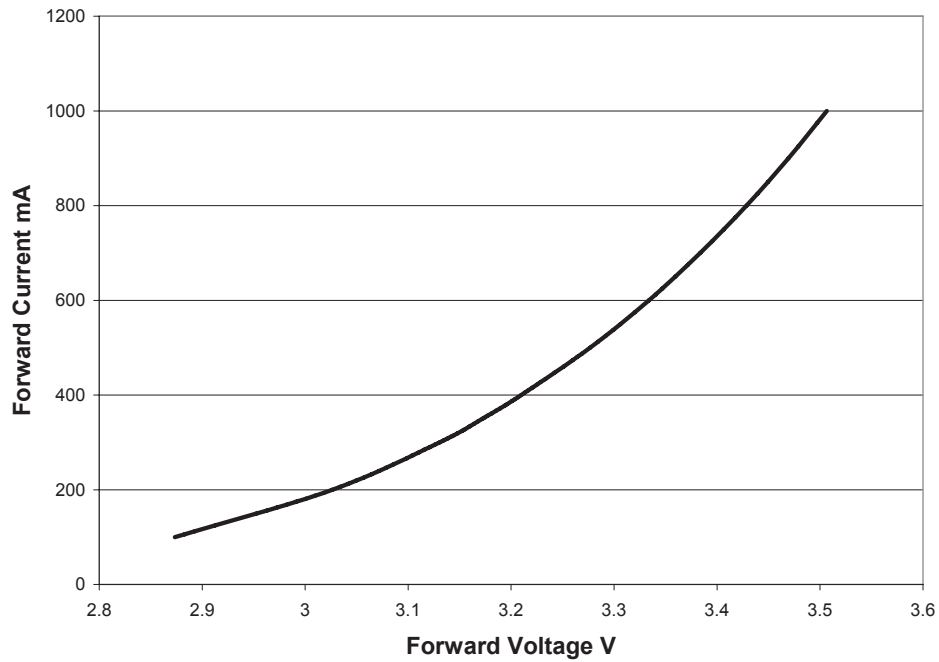

Figure 8. Forward current vs. forward voltage for White, Green, Cyan, Blue and Royal-Blue.

Red, Red-Orange and Amber, Thermal Pad Temperature = 25°C

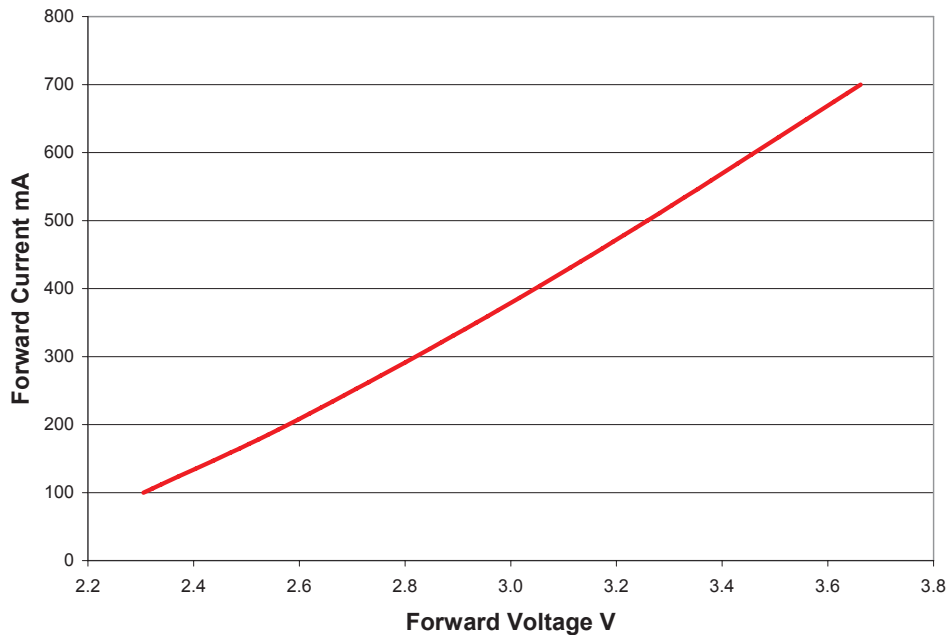

Figure 9. Forward current vs. forward voltage for red, red-orange and amber.

Typical Relative Luminous Flux

Typical Relative Luminous Flux vs. Forward Current for Cool-White, Neutral-White, Warm-White, Green, Cyan, Blue and Royal-Blue, Thermal Pad Temperature = 25°C

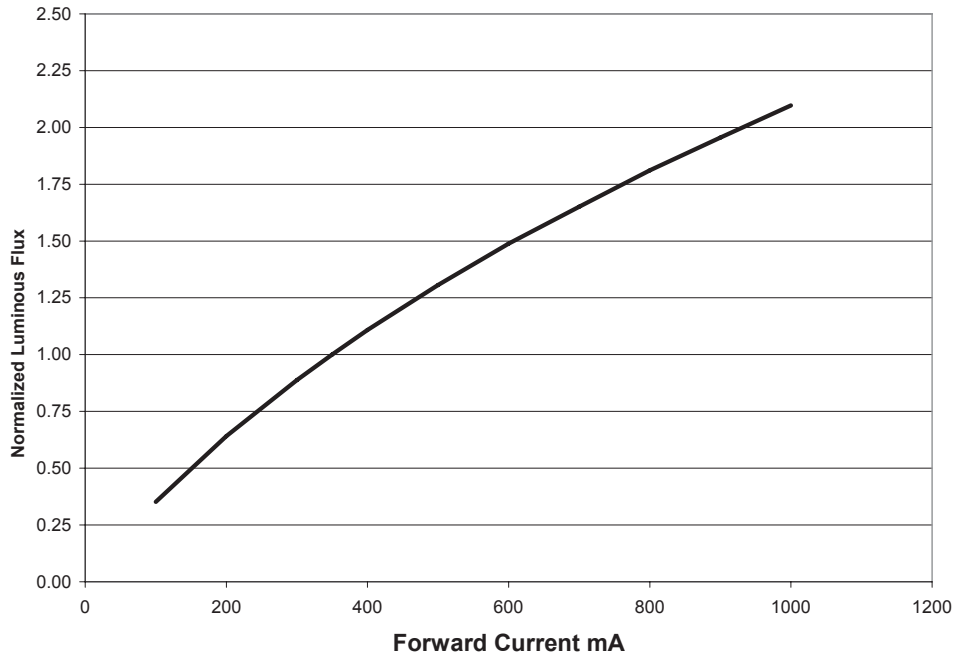

Figure 10. Relative luminous flux or radiometric power vs. forward current for white, green, cyan, blue and royal blue at Thermal Pad = 25°C maintained, test current 350 mA.

Typical Relative Luminous Flux vs. Forward Current for Red, Red-Orange, Amber, Thermal Pad Temperature = 25°C

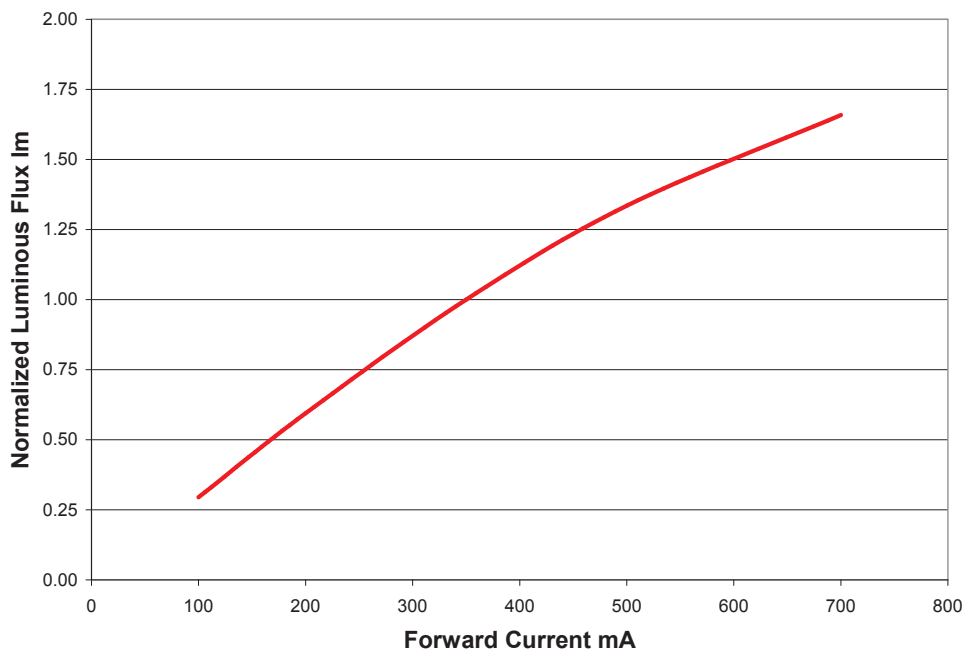

Figure 11. Relative luminous flux vs. forward current for red, red-orange and amber at Thermal Pad = 25°C maintained, test current 350 mA.

Current Derating Curves

Current Derating Curve for 350 mA drive current Cool-White, Neutral-White, Warm-White, Green, Cyan, Blue and Royal-Blue

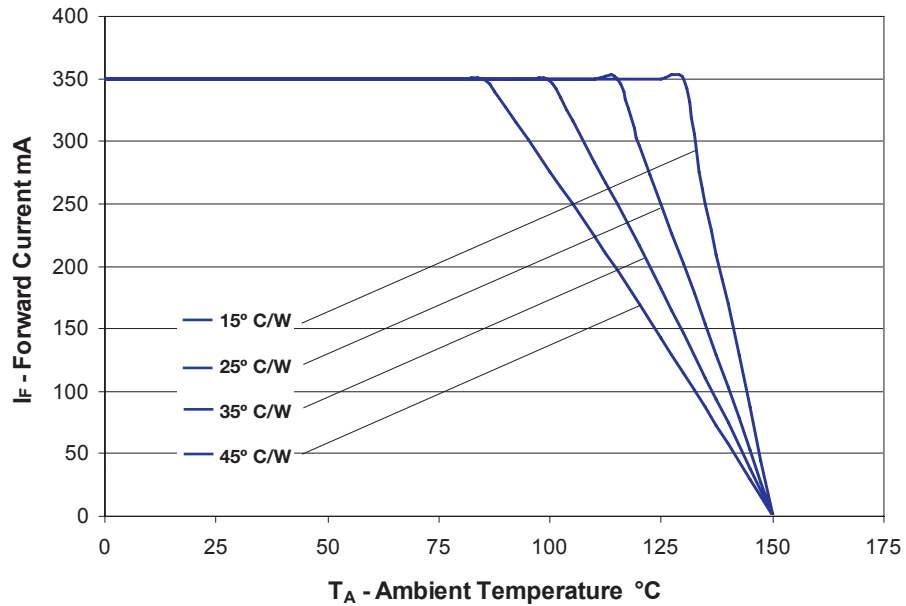

Figure 12: Maximum forward current vs. ambient temperature, based on $T_{JMAX} = 150^{\circ}\text{C}$.

Current Derating Curve for 350 mA drive current Red, Red-Orange, Amber

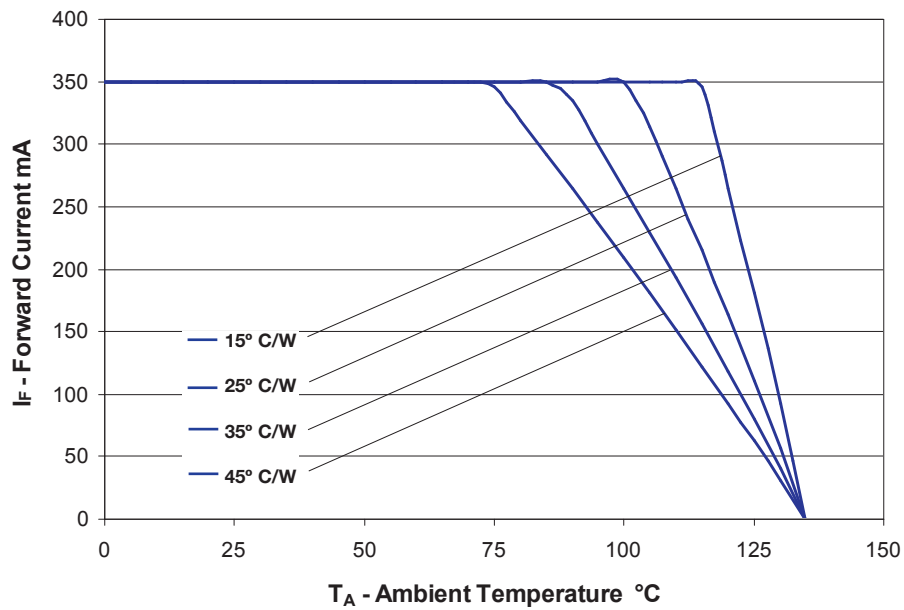

Figure 13: Maximum forward current vs. ambient temperature, based on $T_{JMAX} = 135^{\circ}\text{C}$.

Current Derating Curve for 700 mA drive current Cool-White, Neutral-White, Warm-White, Green, Cyan, Blue and Royal-Blue

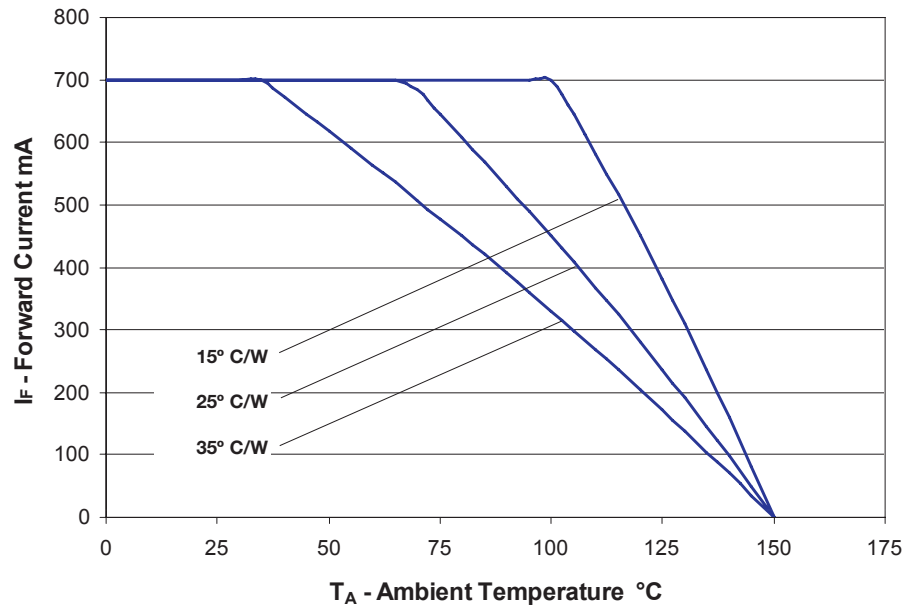

Figure 14: Maximum forward current vs. ambient temperature, based on $T_{JMAX} = 150^{\circ}C$.

Current Derating Curve for 700 mA drive current Red, Red-Orange, Amber

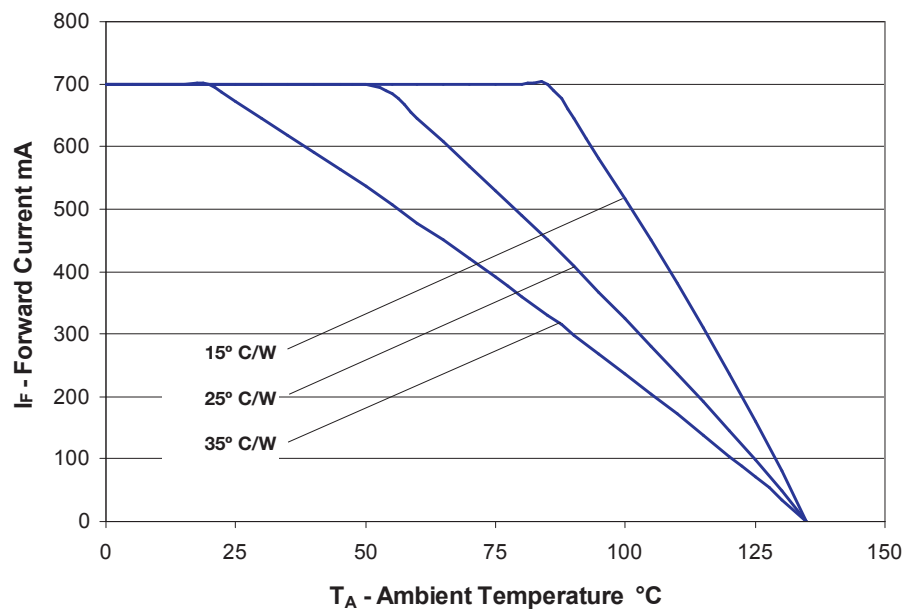

Figure 15: Maximum forward current vs. ambient temperature, based on $T_{JMAX} = 135^{\circ}C$.

Current Derating Curve for 1000mA drive current Cool-White, Neutral-White, Warm-White, Green, Cyan, Blue and Royal-Blue

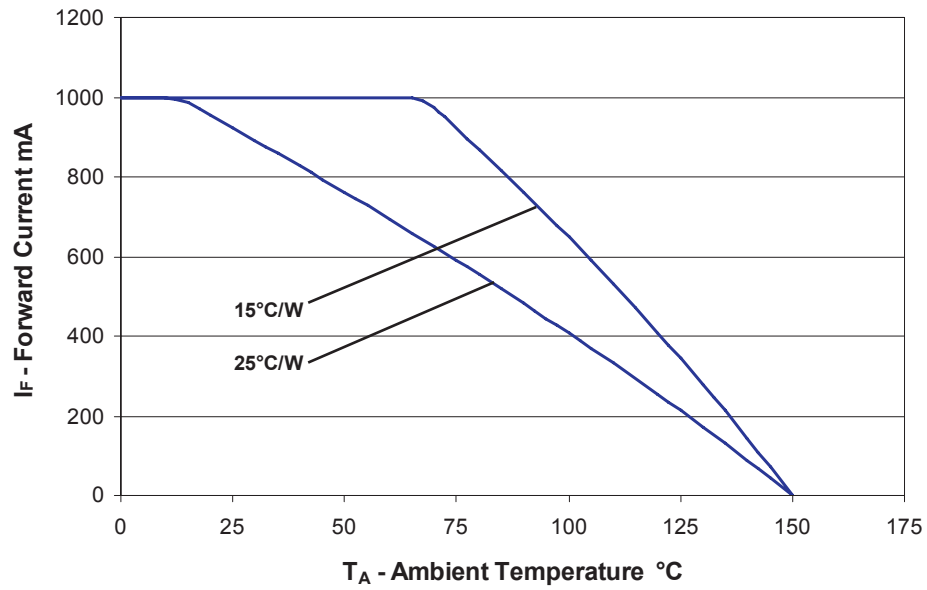

Figure 16: Maximum forward current vs. ambient temperature, based on $T_{JMAX} = 150^{\circ}\text{C}$.

Typical Radiation Patterns

Typical Representative Spatial Radiation Pattern for Cool-White, Neutral-White and Warm-White Lambertian

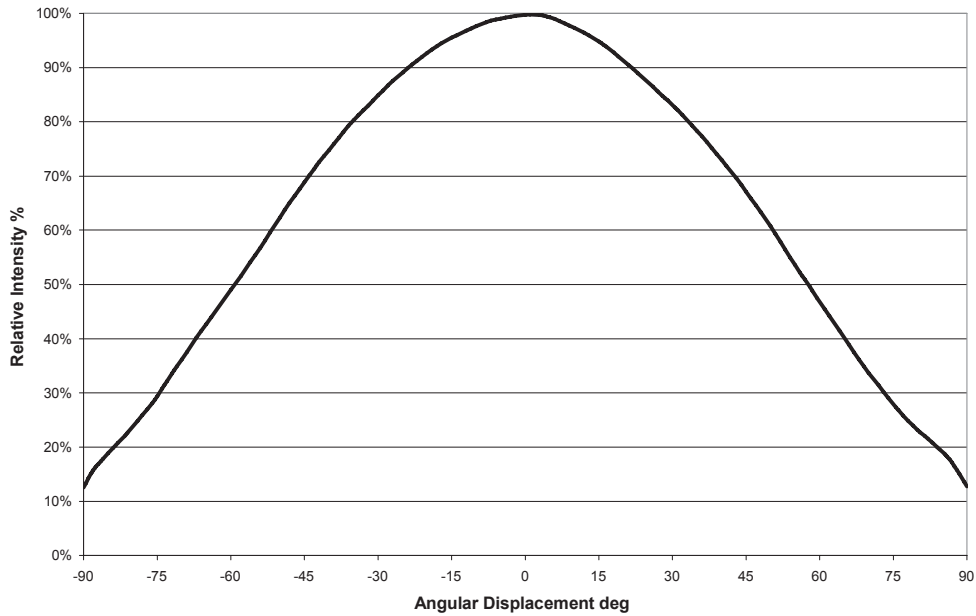

Figure 17: Typical Representative Spatial Radiation Pattern for Cool-White, Neutral-White and Warm-White Lambertian.

Typical Polar Radiation Pattern for White Lambertian

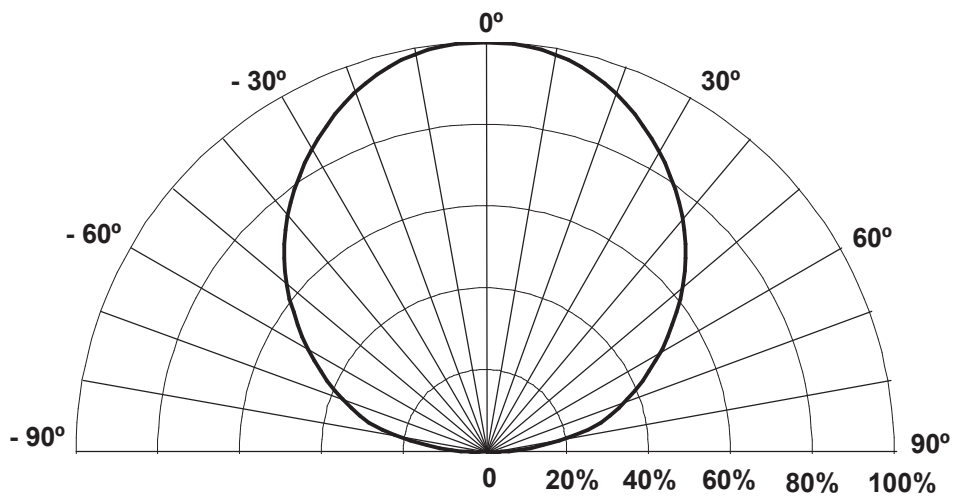

Figure 18: Typical Polar Radiation Pattern for Cool-White, Neutral-White and Warm-White Lambertian.

Typical Representative Spatial Radiation Pattern for Green, Cyan, Blue and Royal-Blue Lambertian

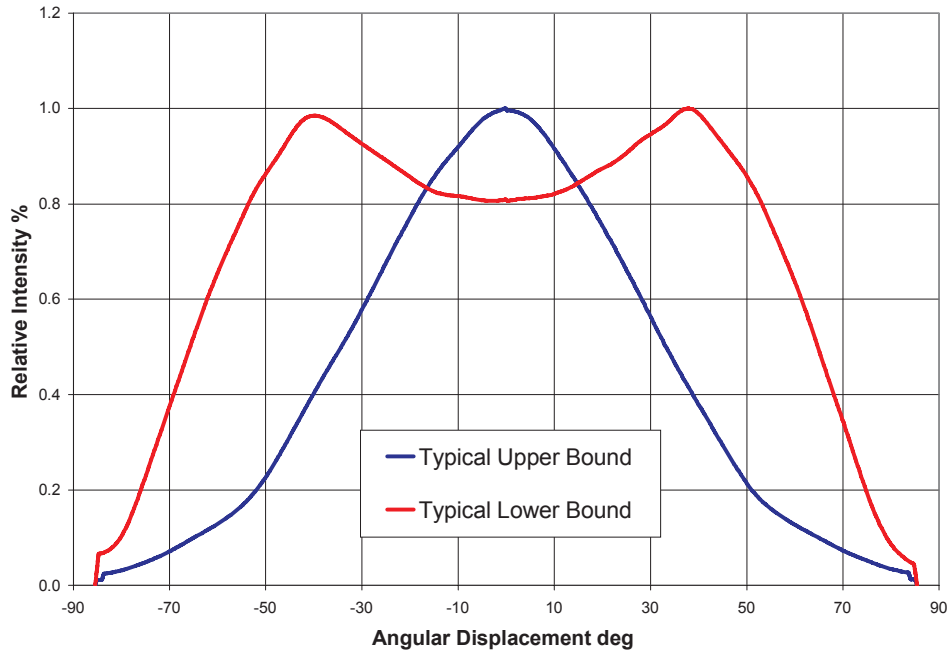

Figure 19: Typical Representative Spatial Radiation Pattern for Green and Royal Blue Lambertian.

Typical Polar Radiation Pattern for Green, Cyan, Blue and Royal-Blue Lambertian

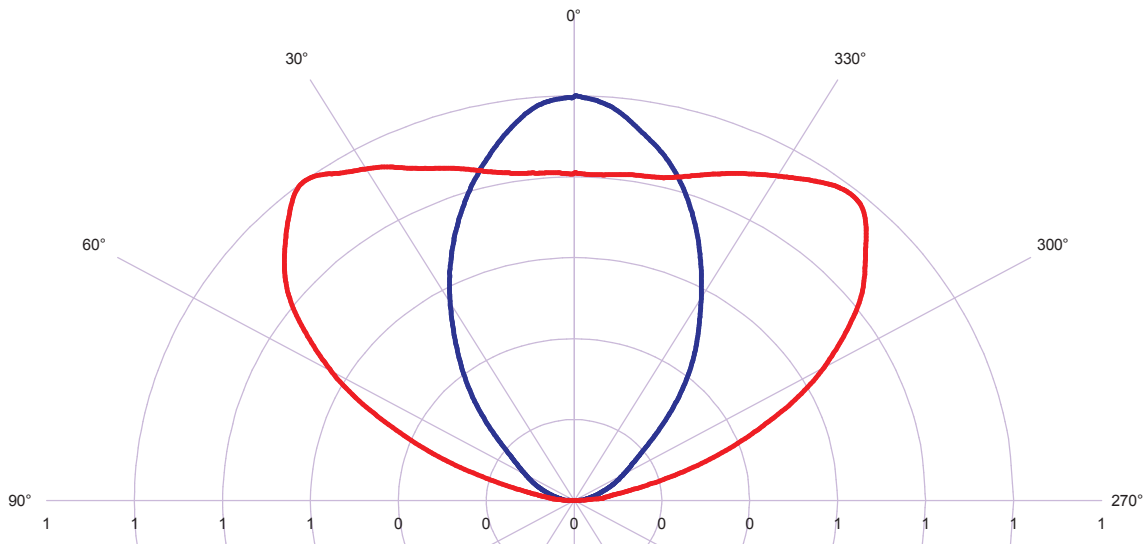

Figure 20: Typical Polar Radiation Pattern for Green and Royal Blue Lambertian.

Typical Representative Spatial Radiation Pattern for Red, Red-Orange and Amber Lambertian

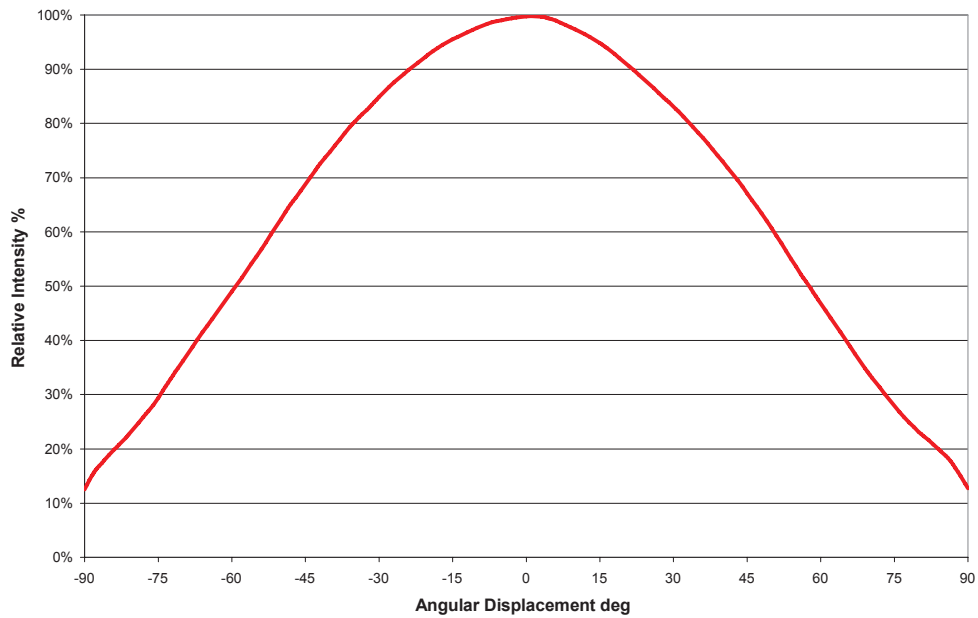

Figure 21: Typical Representative Spatial Radiation Pattern for Red, Red-Orange and Amber Lambertian.

Typical Polar Radiation Pattern for Red, Red-Orange and Amber Lambertian

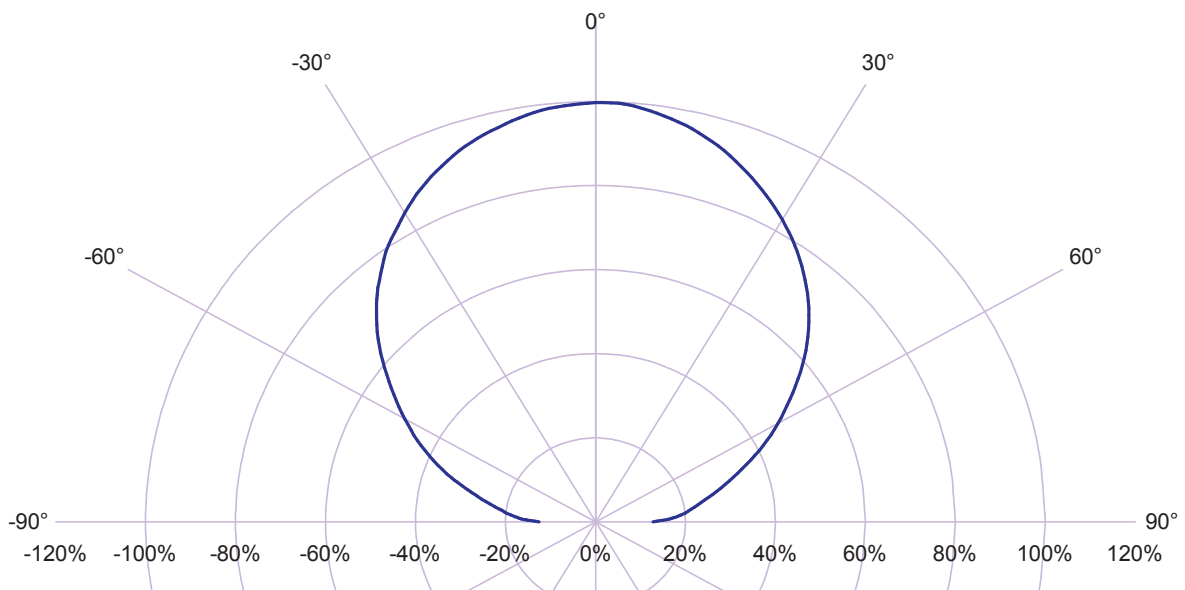
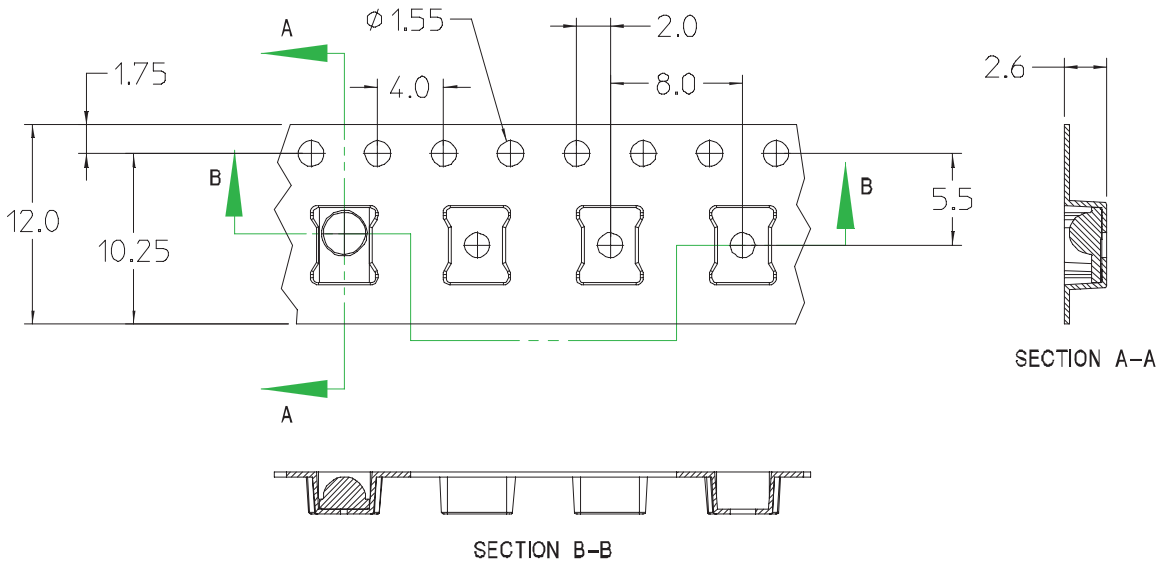
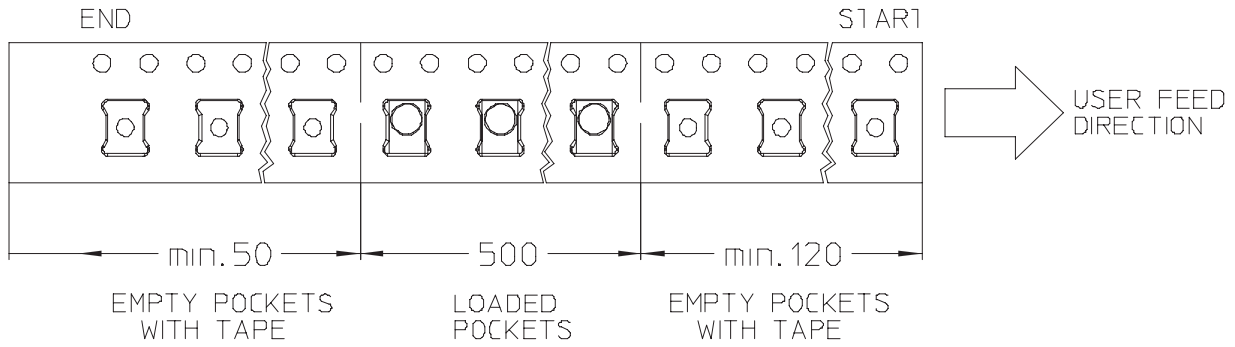
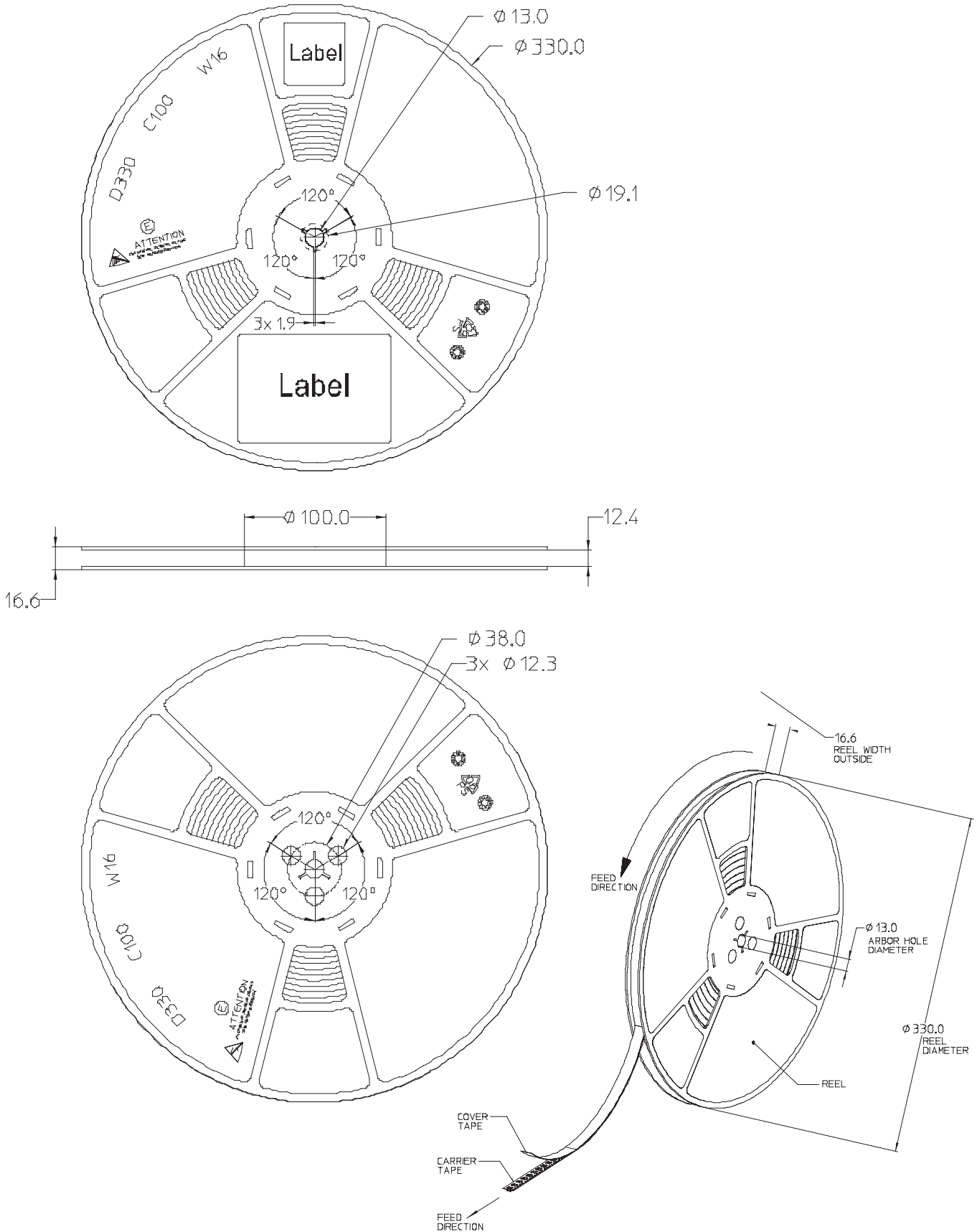

Figure 22: Typical Polar Radiation Pattern for Red, Red-Orange and Amber Lambertian.

Emitter Pocket Tape Packaging



Emitter Reel Packaging



Product Binning and Labeling

Purpose of Product Binning

In the manufacturing of semiconductor products, there is a variation of performance around the average values given in the technical data sheets. For this reason, Philips Lumileds bins the LED components for luminous flux, color and forward voltage (V_F).

Decoding Product Bin Labeling

LUXEON Rebel Emitters are labeled using a three or four digit alphanumeric code (CAT code) depicting the bin values for emitters packaged on a single reel. All emitters packaged within a reel are of the same 3-variable bin combination. Using these codes, it is possible to determine optimum mixing and matching of products for consistency in a given application.

Format of Labeling for Emitters

Reels of Green, Cyan, Blue, Royal-Blue, Red, Red-Orange and Amber Emitters are labeled with a three digit alphanumeric CAT code following the format below.

ABC

A = Flux bin (J, H, J, K etc.)

B = Color bin (2, 4, 6 etc.)

C = V_F bin (D, E, F, G etc.)

Reels of Cool-White, Neutral-White and Warm-White Emitters are labeled with a four digit alphanumeric CAT code following the format below.

ABCD

A = Flux bin (J, H, J, K etc.)

B and C = Color bin (W0, U0, V0 etc.)

C = V_F bin (D, E, F, G etc.)

Luminous Flux Bins

Table 8 lists the standard photometric luminous flux bins for LUXEON Rebel emitters (tested and binned at 350mA).

Although several bins are outlined, product availability in a particular bin varies by production run and by product performance. Not all bins are available in all colors.

Table 8.

Flux Bins - All Colors (except Royal-Blue)		
Bin Code	Minimum Photometric Flux (lm)	Maximum Photometric Flux (lm)
A	8.2	10.7
B	10.7	13.9
C	13.9	18.1
D	18.1	23.5
E	23.5	30
F	30	40
G	40	50
H	50	60
J	60	70
K	70	80
L	80	90
M	90	100
N	100	120
P	120	140
Q	140	160
R	160	180
S	180	200
T	200	220
U	220	240
V	240	260
W	260	280
X	280	300

Table 9.

Flux Bins - Royal-Blue Only (tested and binned at 350mA)		
Bin Code	Minimum Radiometric Flux (mW)	Maximum Radiometric Flux (mW)
A	175	225
B	225	275
C	275	350
D	350	425
E	425	500
F	500	600
G	600	700
H	700	800
J	800	900
K	900	1000

Cool-White Bin Structure

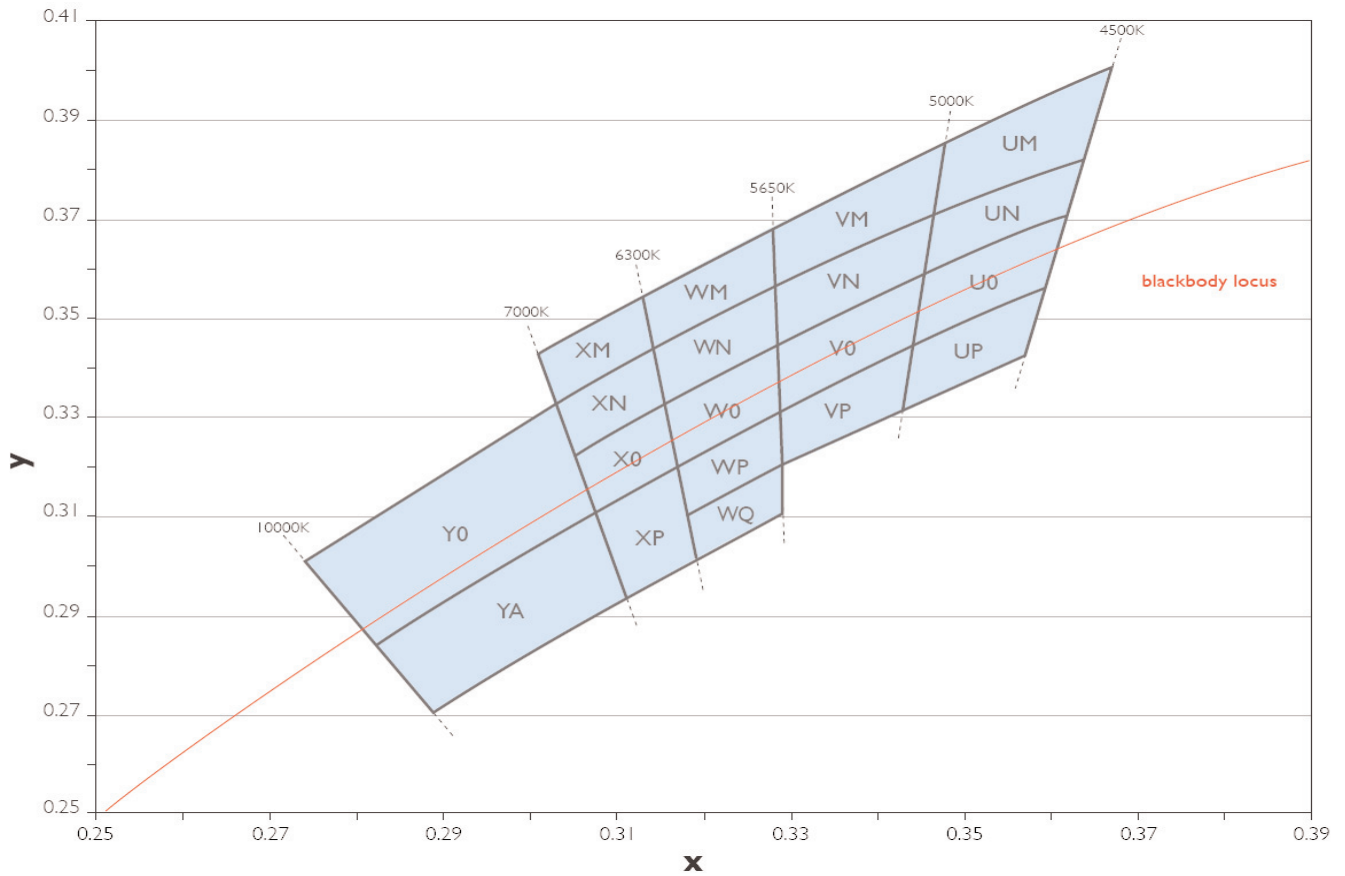

Figure 23: Cool-White Bin Structure.

Cool-White Bin Coordinates

Cool-White LUXEON Rebel Emitters are tested and binned by x,y coordinates.

19 Color Bins, CCT Range 10,000K to 4,500K

Table 10.

Cool-White Bin Coordinates							
Bin Code	X	Y	Typical CCT (K)	Bin Code	X	Y	Typical CCT (K)
Y0	0.274238	0.300667	8000	WQ	0.318606	0.310201	6000
	0.303051	0.332708			0.329393	0.320211	
	0.307553	0.310778			0.329544	0.310495	
	0.282968	0.283772			0.319597	0.301303	
YA	0.282968	0.283772	8000	VM	0.328636	0.368952	5300
	0.307553	0.310778			0.348147	0.385629	
	0.311163	0.293192			0.346904	0.371742	
	0.289922	0.270316			0.328823	0.356917	
XM	0.301093	0.342244	6700	VN	0.328823	0.356917	5300
	0.313617	0.354992			0.346904	0.371742	
	0.314792	0.344438			0.345781	0.359190	
	0.303051	0.332708			0.329006	0.345092	
XN	0.303051	0.332708	6700	V0	0.329006	0.345092	5300
	0.314792	0.344438			0.345781	0.359190	
	0.316042	0.333222			0.344443	0.344232	
	0.305170	0.322386			0.329220	0.331331	
X0	0.305170	0.322386	6700	VP	0.329220	0.331331	5300
	0.316042	0.333222			0.344443	0.344232	
	0.317466	0.320438			0.343352	0.332034	
	0.307553	0.310778			0.329393	0.320211	
XP	0.307553	0.310778	6700	UM	0.348147	0.385629	4750
	0.317466	0.320438			0.367294	0.400290	
	0.319597	0.301303			0.364212	0.382878	
	0.311163	0.293192			0.346904	0.371742	
WM	0.313617	0.354992	6000	UN	0.346904	0.371742	4750
	0.328636	0.368952			0.364212	0.382878	
	0.328823	0.356917			0.362219	0.371616	
	0.314792	0.344438			0.345781	0.359190	
WN	0.314792	0.344438	6000	U0	0.345781	0.359190	4750
	0.328823	0.356917			0.362219	0.371616	
	0.329006	0.345092			0.359401	0.355699	
	0.316042	0.333222			0.344443	0.344232	
W0	0.316042	0.333222	6000	UP	0.344443	0.344232	4750
	0.329006	0.345092			0.359401	0.355699	
	0.329220	0.331331			0.357079	0.342581	
	0.317466	0.320438			0.343352	0.332034	
WP	0.317466	0.320438	6000				
	0.329220	0.331331					
	0.329393	0.320211					
	0.318606	0.310201					

Note for Table 10:

1. Philips Lumileds maintains a tester tolerance of ± 0.005 on x, y color coordinates.

Neutral-White Bin Structure

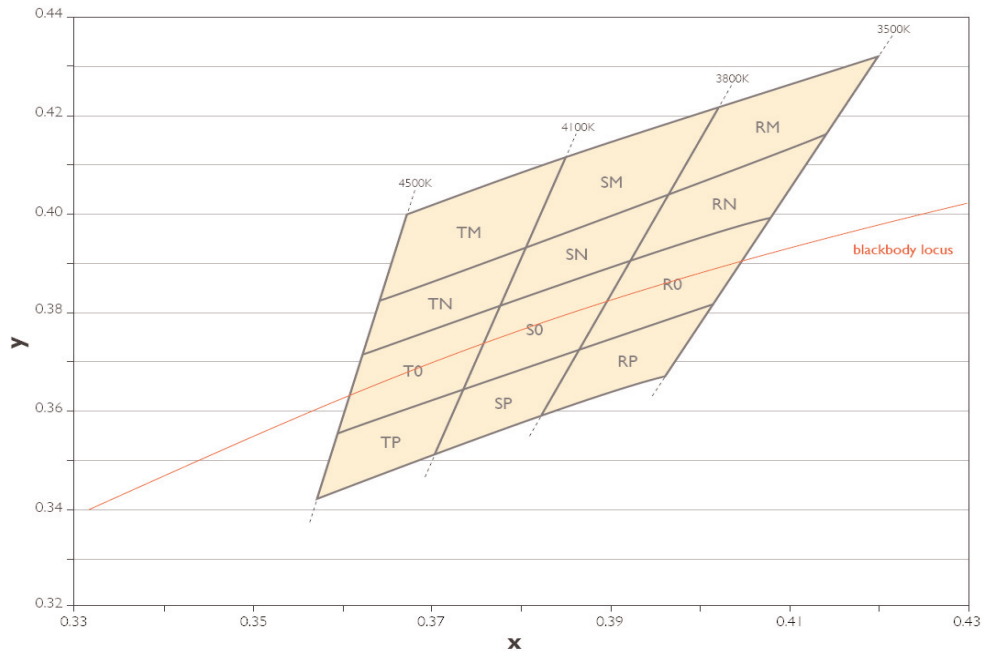

Figure 24: Neutral-White Bin Structure.

Neutral-White LUXEON Rebel Emitters are tested and binned by x,y coordinates. 12 Color Bins, CCT Range 4,500K to 3,500K

Table 11.

Neutral-White Bin Coordinates							
Bin Code	X	Y	Typical CCT (K)	Bin Code	X	Y	Typical CCT (K)
TM	0.367294	0.400290	4300	S0	0.378264	0.382458	3950
	0.385953	0.412995			0.392368	0.390932	
	0.381106	0.393747			0.387071	0.373899	
	0.364212	0.382878			0.374075	0.365822	
TN	0.364212	0.382878	4300	SP	0.374075	0.365822	3950
	0.381106	0.393747			0.387071	0.373899	
	0.378264	0.382458			0.382598	0.359515	
	0.362219	0.371616			0.370582	0.351953	
TO	0.362219	0.371616	4300	RM	0.402270	0.422776	3650
	0.378264	0.382458			0.420940	0.432618	
	0.374075	0.365822			0.414776	0.416097	
	0.359401	0.355699			0.396279	0.403508	
TP	0.359401	0.355699	4300	RN	0.396279	0.403508	3650
	0.374075	0.365822			0.414776	0.416097	
	0.370582	0.351953			0.408593	0.399525	
	0.357079	0.342581			0.392368	0.390932	
SM	0.385953	0.412995	3950	R0	0.392368	0.390932	3650
	0.402270	0.422776			0.408593	0.399525	
	0.396279	0.403508			0.402113	0.382156	
	0.381106	0.393747			0.387071	0.373899	
SN	0.381106	0.393747	3950	RP	0.387071	0.373899	3650
	0.396279	0.403508			0.402113	0.382156	
	0.392368	0.390932			0.396564	0.367284	
	0.378264	0.382458			0.382598	0.359515	

Note for Table 11:

1. Philips Lumileds maintains a tester tolerance of ± 0.005 on x, y color coordinates.

Warm-White Bin Structure

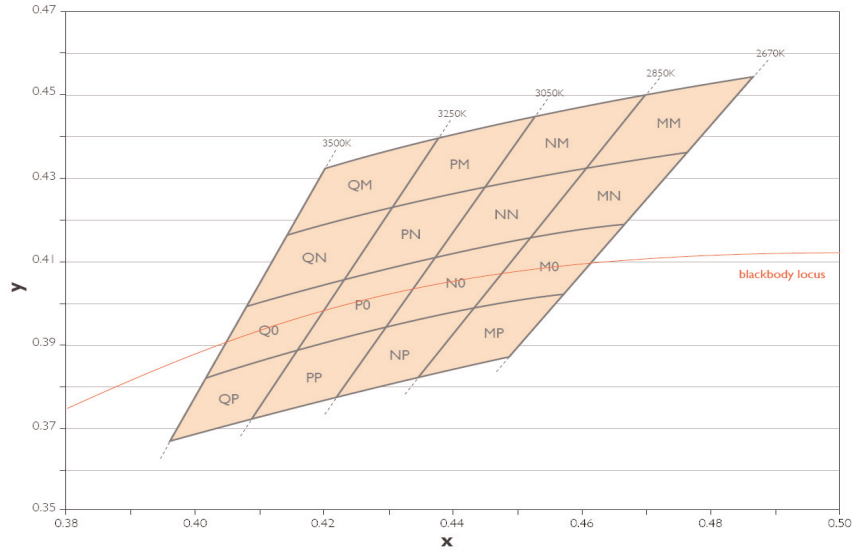

Figure 25: Warm-White Bin Structure.

Warm-White LUXEON Rebel Emitters are tested and binned by x,y coordinates. 16 Color Bins, CCT Range 3,500K to 2,670K

Table 12.

Warm-White Bin Coordinates							
Bin Code	X	Y	Typical CCT (K)	Bin Code	X	Y	Typical CCT (K)
QM	0.420940	0.432618	3375	NM	0.453820	0.445980	2950
	0.438458	0.440399			0.470507	0.450832	
	0.431186	0.423386			0.461404	0.433334	
	0.414776	0.416097			0.445639	0.428680	
QN	0.414776	0.416097	3375	NN	0.445639	0.428680	2950
	0.431186	0.423386			0.461404	0.433334	
	0.423956	0.406472			0.452512	0.416241	
	0.408593	0.399525			0.437578	0.411632	
QO	0.408593	0.399525	3375	N0	0.437578	0.411632	2950
	0.423956	0.406472			0.452512	0.416241	
	0.416487	0.389001			0.443600	0.399111	
	0.402113	0.382156			0.429373	0.394281	
QP	0.402113	0.382156	3375	NP	0.429373	0.394281	2950
	0.416487	0.389001			0.443600	0.399111	
	0.409996	0.373814			0.435591	0.383714	
	0.396564	0.367284			0.422124	0.378952	
PM	0.438458	0.440399	3150	MM	0.470507	0.450832	2760
	0.453820	0.445980			0.486648	0.454191	
	0.445639	0.428680			0.476733	0.436634	
	0.431186	0.423386			0.461404	0.433334	
PN	0.431186	0.423386	3150	MN	0.461404	0.433334	2760
	0.445639	0.428680			0.476733	0.436634	
	0.437578	0.411632			0.467132	0.419632	
	0.423956	0.406472			0.452512	0.416241	
P0	0.423956	0.406472	3150	M0	0.452512	0.416241	2760
	0.437578	0.411632			0.467132	0.419632	
	0.429373	0.394281			0.457663	0.402866	
	0.416487	0.389001			0.443600	0.399111	
PP	0.416487	0.389001	3150	MP	0.443600	0.399111	2760
	0.429373	0.394281			0.457663	0.402866	
	0.422124	0.378952			0.448994	0.387515	
	0.409996	0.373814			0.435591	0.383714	

Note for Table 12:

1. Philips Lumileds maintains a tester tolerance of ± 0.005 on x, y color coordinates.

Color Bins

Green, Cyan and Blue LUXEON Rebel Emitters are tested and binned for dominant wavelength.

Dominant Wavelength Bin Structure for Green Emitters

Table 13.

Bin Code	Minimum Dominant Wavelength (nm)	Maximum Dominant Wavelength (nm)
1	520	525
2	525	530
3	530	535
4	535	540
5	540	545
6	545	550

Dominant Wavelength Bin Structure for Cyan Emitters

Table 14.

Bin Code	Minimum Dominant Wavelength (nm)	Maximum Dominant Wavelength (nm)
1	490	495
2	495	500
3	500	505
4	505	510
5	510	515
6	515	520

Dominant Wavelength Bin Structure for Blue Emitters

Table 15.

Bin Code	Minimum Dominant Wavelength (nm)	Maximum Dominant Wavelength (nm)
1	460	465
2	465	470
3	470	475
4	475	480
5	480	485
6	485	490

Royal-Blue Luxeon Rebel Emitters are tested and binned for peak wavelength.

Peak Wavelength Bin Structure for Royal-Blue Emitters

Table 16.

Bin Code	Minimum Peak Wavelength (nm)	Maximum Peak Wavelength (nm)
3	440	445
4	445	450
5	450	455
6	455	460
7	460	465
8	465	470

Red, Red-Orange and Amber LUXEON Rebel Emitters are tested and binned for dominant wavelength.

Dominant Wavelength Bin Structure for Red Emitters

Table 17.

Bin Code	Minimum Dominant Wavelength (nm)	Maximum Dominant Wavelength (nm)
4	620.5	631.0
5	631.0	645.0

Dominant Wavelength Bin Structure for Red-Orange Emitters

Table 18.

Bin Code	Minimum Dominant Wavelength (nm)	Maximum Dominant Wavelength (nm)
2	613.5	620.5

Dominant Wavelength Bin Structure for Amber Emitters

Table 19.

Amber Dominant Wavelength Bins		
Bin Code	Minimum Dominant Wavelength (nm)	Maximum Dominant Wavelength (nm)
1	584.5	587.0
2	587.0	589.5
4	589.5	592.0
6	592.0	594.5
7	594.5	597.0

Forward Voltage Bins

Table 20 lists minimum and maximum V_F bin values per emitter. Although several bins are outlined, product availability in a particular bin varies by production run and by product performance.

Table 20.

V_F Bins		
Bin Code	Minimum Forward Voltage (V)	Maximum Forward Voltage (V)
A	2.31	2.55
B	2.55	2.79
C	2.79	3.03
D	3.03	3.27
E	3.27	3.51
F	3.51	3.75
G	3.75	3.99



Company Information

Philips Lumileds Lighting Company is a world class supplier of Light Emitting Diodes (LEDs) and produces billions of LEDs annually. Philips Lumileds is a fully integrated supplier producing core LED material in all three base colors (red, green, blue) and white. Philips Lumileds has R&D centers in San Jose, California and in The Netherlands as well as production capabilities in San Jose, Penang Malaysia and Singapore. Founded in 1999, Philips Lumileds is the high-flux LED technology leader and is dedicated to bridging the gap between solid-state LED technology and the lighting world. Philips Lumileds technologies, LEDs and systems are enabling new applications and markets in the lighting world.

Philips Lumileds may make process or materials changes affecting the performance or other characteristics of our products. These products supplied after such changes will continue to meet published specifications, but may not be identical to products supplied as samples or under prior orders.



WWW.LUXEON.COM
WWW.LUMILEDSFUTURE.COM

FOR TECHNICAL ASSISTANCE OR THE LOCATION OF YOUR NEAREST SALES OFFICE CONTACT ANY OF THE FOLLOWING:

NORTH AMERICA:
+1 888 589 3662 OR
ASKLUXEON@FUTUREELECTRONICS.COM

EUROPE:
OO 800 443 88 873 OR
LUXEON.EUROPE@FUTUREELECTRONICS.COM

ASIA:
800 5864 5337 OR
LUMILEDS.ASIA@FUTUREELECTRONICS.COM



Компания «ЭлектроПласт» предлагает заключение долгосрочных отношений при поставках импортных электронных компонентов на взаимовыгодных условиях!

Наши преимущества:

- Оперативные поставки широкого спектра электронных компонентов отечественного и импортного производства напрямую от производителей и с крупнейших мировых складов;
- Поставка более 17-ти миллионов наименований электронных компонентов;
- Поставка сложных, дефицитных, либо снятых с производства позиций;
- Оперативные сроки поставки под заказ (от 5 рабочих дней);
- Экспресс доставка в любую точку России;
- Техническая поддержка проекта, помощь в подборе аналогов, поставка прототипов;
- Система менеджмента качества сертифицирована по Международному стандарту ISO 9001;
- Лицензия ФСБ на осуществление работ с использованием сведений, составляющих государственную тайну;
- Поставка специализированных компонентов (Xilinx, Altera, Analog Devices, Intersil, Interpoint, Microsemi, Aeroflex, Peregrine, Syfer, Eurofarad, Texas Instrument, Miteq, Cobham, E2V, MA-COM, Hittite, Mini-Circuits, General Dynamics и др.);

Помимо этого, одним из направлений компании «ЭлектроПласт» является направление «Источники питания». Мы предлагаем Вам помощь Конструкторского отдела:

- Подбор оптимального решения, техническое обоснование при выборе компонента;
- Подбор аналогов;
- Консультации по применению компонента;
- Поставка образцов и прототипов;
- Техническая поддержка проекта;
- Защита от снятия компонента с производства.



Как с нами связаться

Телефон: 8 (812) 309 58 32 (многоканальный)

Факс: 8 (812) 320-02-42

Электронная почта: org@eplast1.ru

Адрес: 198099, г. Санкт-Петербург, ул. Калинина, дом 2, корпус 4, литера А.