

DESCRIPTION

The MP3394 is a step-up controller with 4-channel current sources designed for driving the WLED arrays for large size LCD panel backlighting applications. The MP3394 is flexible for extending LED channels with two or more MP3394s in parallel while operating from a single inductor power source.

The MP3394 uses current mode, fixed frequency architecture. The switching frequency is programmable by an external frequency setting resistor. It drives an external MOSFET to boost up the output voltage from a 5V to 28V input supply. The MP3394 regulates the current in each LED string to the programmed value set by an external current setting resistor.

The MP3394 applies 4 internal current sources for current balance and the current matching can achieve 2.5% regulation accuracy between strings. Its low 350mV regulation voltage on LED current sources reduces power loss and improves efficiency.

PWM dimming is implemented with external PWM input signal or DC input signal. The dimming PWM signal can be generated internally and the dimming frequency is programmed by an external setting capacitor.

TYPICAL APPLICATION



FEATURES

- 4-String, Max 200mA/String WLED Driver
- 5V to 28V Input Voltage Range
- 2.5% Current Matching Accuracy Between Strings
- Programmable Switching Frequency
- PWM or DC Input Burst PWM Dimming
- Open and Short LED Protection
- Programmable Over-Voltage Protection
- Cascading Capability with a Single Power Source
- Under Voltage Lockout
- Thermal Shutdown
- TSSOP16EP, SOIC16, SOIC20 Package

APPLICATIONS

- Desktop LCD Flat Panel Displays
- Flat Panel Video Displays
- LCD TVs and Monitors

All MPS parts are lead-free and adhere to the RoHS directive. For MPS green status, please visit MPS website under Quality Assurance. "MPS" and "The Future of Analog IC Technology" are Registered Trademarks of Monolithic Power Systems, Inc.

ORDERING INFORMATION

Part Number	Package	Top Marking
MP3394EF*	TSSOP16EP	MP3394
MP3394ES**	SOIC16	MP3394
MP3394EY***	SOIC20	MP3394

*For Tape & Reel, add suffix -Z (e.g. MP3394EF-Z).
For RoHS compliant packaging, add suffix -LF (e.g. MP3394EF-LF-Z)

**For Tape & Reel, add suffix -Z (e.g. MP3394ES-Z).
For RoHS compliant packaging, add suffix -LF (e.g. MP3394ES-LF-Z)

***For Tape & Reel, add suffix -Z (e.g. MP3394EY-Z).
For RoHS compliant packaging, add suffix -LF (e.g. MP3394EY-LF-Z)

PACKAGE REFERENCE



ABSOLUTE MAXIMUM RATINGS ⁽¹⁾

V_{IN}	-0.3V to +30V
V_{GATE}	-0.5V to 6.8V
V_{CC}	-0.5V to 6.8V
V_{LED1} to V_{LED4}	-1V to +55V
All Other Pins	-0.3V to +6.3V

Continuous Power Dissipation ($T_A = +25^\circ\text{C}$) ⁽²⁾

TSSOP16EP	2.78 W
SOIC16	1.56 W
SOIC20	1.74W
Junction Temperature	150°C
Lead Temperature	260°C
Storage Temperature	-65°C to +150°C

Recommended Operating Conditions ⁽³⁾

Supply Voltage V_{IN}	5V to 28V
LED Current (Backlight)	10mA to 180mA
Operating Junction Temp. (T_J)	-20°C to +125°C

Thermal Resistance ⁽⁴⁾ θ_{JA} θ_{JC}

TSSOP16EP	45	10 ... °C/W
SOIC16	80	35 ... °C/W
SOIC20	72	30 ... °C/W

Notes:

- Exceeding these ratings may damage the device.
- The maximum allowable power dissipation is a function of the maximum junction temperature T_J (MAX), the junction-to-ambient thermal resistance θ_{JA} , and the ambient temperature T_A . The maximum allowable continuous power dissipation at any ambient temperature is calculated by P_d (MAX) = $(T_J$ (MAX) - T_A) / θ_{JA} . Exceeding the maximum allowable power dissipation will cause excessive die temperature, and the regulator will go into thermal shutdown. Internal thermal shutdown circuitry protects the device from permanent damage.
- The device is not guaranteed to function outside of its operation conditions.
- Measured on JESD51-7, 4-layer PCB.

ELECTRICAL CHARACTERISTICS $V_{IN} = 12V$, $V_{EN} = 5V$, $T_A = +25^\circ C$, unless otherwise noted.

Parameters	Symbol	Condition	Min	Typ	Max	Units
Operating Input Voltage	V_{IN}		5		28	V
Supply Current (Quiescent)	I_Q	$V_{IN}=12V$, $V_{EN}=5V$, no load with switching		4		mA
Supply Current (Shutdown)	I_{ST}	$V_{EN}=0V$, $V_{IN}=12V$			2	μA
LDO Output Voltage	V_{CC}	$V_{EN}=5V$, $0 < I_{VCC} < 10mA$ $7V < V_{IN} < 28V$,	5.5	6	6.5	V
Input UVLO Threshold	V_{IN_UVLO}	Rising Edge	3.8	4.2	4.6	V
Input UVLO Hysteresis				200		mV
EN High Voltage	V_{EN_HIGH}	V_{EN} Rising	1.8			V
EN Low Voltage	V_{EN_LOW}	V_{EN} Falling			0.6	V
STEP-UP CONVERTER						
Gate Driver Impedance (Sourcing)		$V_{CC}=6V$, $V_{GATE}=6V$		4		Ω
Gate Driver Impedance (Sinking)		$V_{CC}=6V$, $I_{GATE}=10mA$		2		Ω
Switching Frequency	f_{SW}	$R_{OSC} = 115k\Omega$	480	540	600	kHz
		$R_{OSC} = 374k\Omega$	145	165	185	kHz
OSC Voltage	V_{OSC}		1.20	1.23	1.26	V
Minimum On Time	T_{ON_MIN}	PWM Mode, when no pulse skipping happens		100		ns
Maximum Duty Cycle	D_{MAX}		90			%
ISENSE Limit		Max Duty Cycle	150	200	250	mV
COMP Source Current Limit	I_{COMP_SOLI}			65		μA
COMP Sink Current Limit	I_{COMP_SILI}			15		μA
PWM DIMMING						
DBRT Leakage Current	I_{DBRT_LK}		-5		5	μA
BOSC Frequency	F_{BOSC}	$C_{BOSC}=2.2nF$	1.0	1.5	2	kHz
BOSC Output Current	I_{BOSC}		6	7.5	9	μA
LED CURRENT REGULATION						
ISET Voltage	V_{ISET}		1.20	1.23	1.25	V
LEDX Average Current	I_{LED}	$R_{ISET}=30k\Omega$	31	32	33	mA
Current Matching ⁽⁵⁾		$I_{LED}=32mA$			2.5	%

ELECTRICAL CHARACTERISTICS *(continued)*
 $V_{IN} = 12V$, $V_{EN} = 5V$, $T_A = +25^{\circ}C$, unless otherwise noted.

Parameters	Symbol	Condition	Min	Typ	Max	Units
LEDX Regulation Voltage	V_{LEDX}	$I_{LED}=32mA$		350		mV
PROTECTION						
OVP(Over Voltage Protection) Threshold	V_{OVP_OV}	Rising Edge	1.20	1.23	1.26	V
OVP UVLO threshold	V_{OVP_UV}	Step-up Converter Fails	50	70	90	mV
LEDX UVLO Threshold	V_{LEDX_UV}		156	196	236	mV
LEDX Over Voltage Threshold	V_{LEDX_OV}		5.8	6.3	6.8	V
Thermal Shutdown Threshold	T_{ST}			150		$^{\circ}C$

Notes:

5) Matching is defined as the difference of the maximum to minimum current divided by 2 times average currents.

NOT RECOMMENDED FOR NEW DESIGNS REFER TO MP3394S

PIN FUNCTIONS

TSSOP16EP & SOIC16	SOIC20	Name	Description
1	1	COMP	Step-up Converter Compensation Pin. This pin is used to compensate the regulation control loop. Connect a ceramic capacitor from COMP to GND.
2	2	EN	Enable Control Input. Do not let this pin float.
3	3	DBRT	Brightness Control Input. To use external PWM dimming mode, apply a PWM signal on this pin for brightness control. To use DC input PWM dimming mode, apply a DC voltage range from 0.2V to 1.2V on this pin linearly to set the internal dimming duty cycle from 0% to 100%. The MP3394 has positive dimming polarity on DBRT.
4	5	GND	Ground.
5	7	OSC	Switching Frequency Set. Connect a resistor between OSC and GND to set the step-up converter switching frequency. The voltage at this pin is regulated to 1.23V. The clock frequency is proportional to the current sourced from this pin.
6	8	ISET	LED Current Set. Tie a current setting resistor from this pin to ground to program the current in each LED string. This pin voltage is regulated to 1.23V. The LED current is proportional to the current through the ISET resistor.
7	9	BOSC	Dimming Repetition Set. This is the timing pin for the oscillator to set the dimming frequency. To use DC input PWM dimming mode, connect a capacitor from this pin to GND to set the internal dimming frequency. A sawtooth waveform is generated on this pin. To use external PWM dimming mode, connect a resistor from this pin to GND, and apply the PWM signal on DBRT pin.
8	10	LED4	LED String 4 Current Input. This pin is the open-drain output of an internal dimming control switch. Connect the LED String 4 cathode to this pin.
9	11	LED3	LED String 3 Current Input. This pin is the open-drain output of an internal dimming control switch. Connect the LED String 3 cathode to this pin.
10	12	LED2	LED String 2 Current Input. This pin is the open-drain output of an internal dimming control switch. Connect the LED String 2 cathode to this pin.
11	13	LED1	LED String 1 Current Input. This pin is the open-drain output of an internal dimming control switch. Connect the LED String 1 cathode to this pin.
12	14	OVP	Over-voltage Protection Input. Connect a resistor divider from output to this pin to program the OVP threshold. When this pin voltage reaches 1.23V, the MP3394 triggers Over Voltage Protection mode.

PIN FUNCTIONS *(continued)*

TSSOP16EP & SOIC16	SOIC20	Name	Description
13	17	ISENSE	Current Sense Input. During normal operation, this pin senses the voltage across the external inductor current sensing resistor for peak current mode control and also to limit the inductor current during every switching cycle. If this pin is not used in extending application with other master MP3394, tie this pin to GND, do not let this pin floating.
14	18	GATE	Step-up Converter Power Switch Gate Output. This pin drives the external power N-MOS device.
15	19	VIN	Supply Input. VIN supplies the power to the chip, as well as the step-up converter switch. Drive VIN with a 5V to 28V power source. Must be locally bypassed.
16	20	VCC	The Internal 6V Linear Regulator Output. VCC provides power supply for the external MOSFET switch gate driver and the internal control circuitry. Bypass VCC to GND with a ceramic capacitor.
	4, 6, 15, 16	NC	No Connect.

TYPICAL PERFORMANCE CHARACTERISTICS

$V_{IN} = 12V$, 12 LEDs in series, 4 strings parallel, 120mA/string, unless otherwise noted.

Efficiency vs. V_{in}

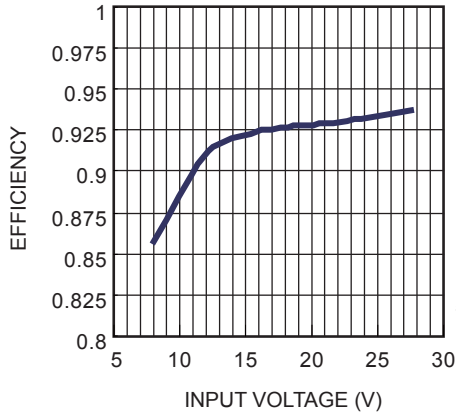

Steady State

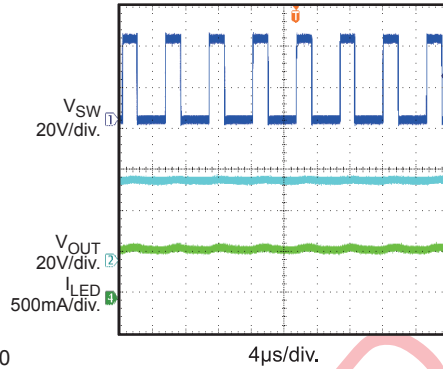

V_{in} Startup

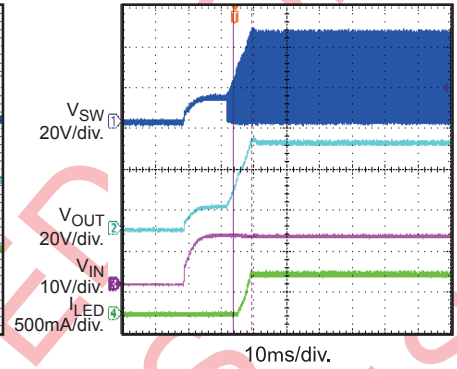

V_{en} Startup

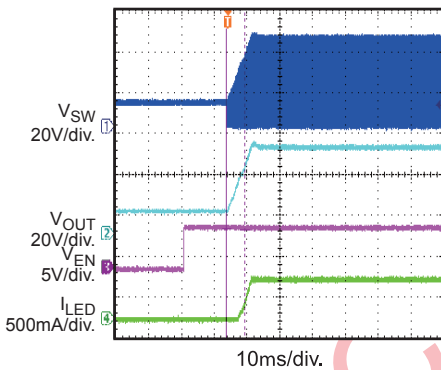

DC Burst Dimming

$V_{PWM} = 0.1V$, $C_{BOSC} = 1.8nF$

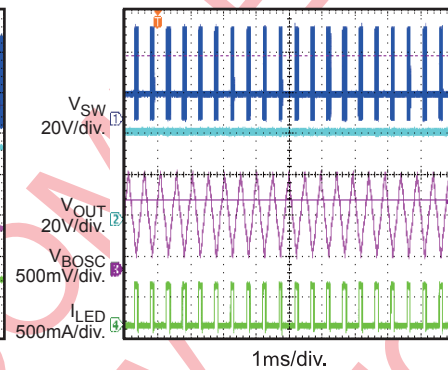

External PWM Dimming

$f_{PWM} = 2kHz$, $D_{PWM} = 50%$

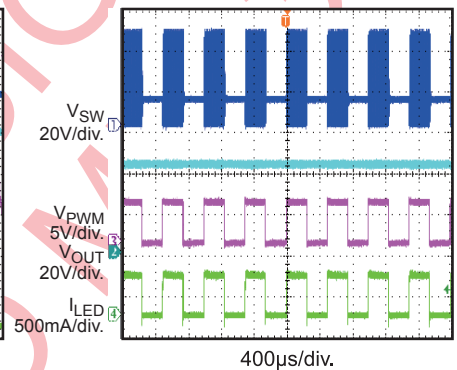

Open LED Protection

Open all LED strings at working

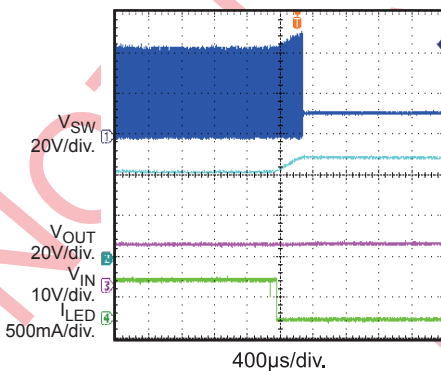

Open LED Protection

Open one LED string at working

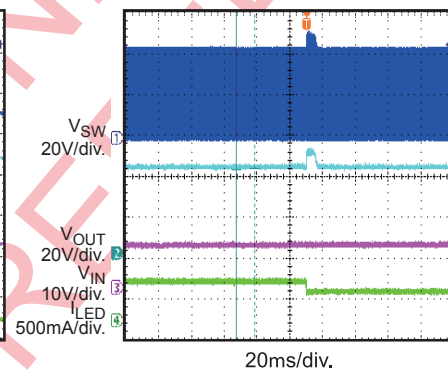

Short LED Protection

Short V_{OUT} to LEDx at working

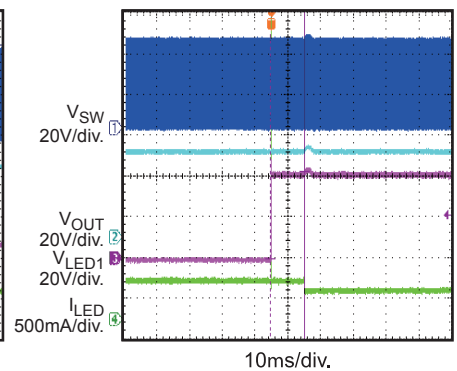

FUNCTION DIAGRAM

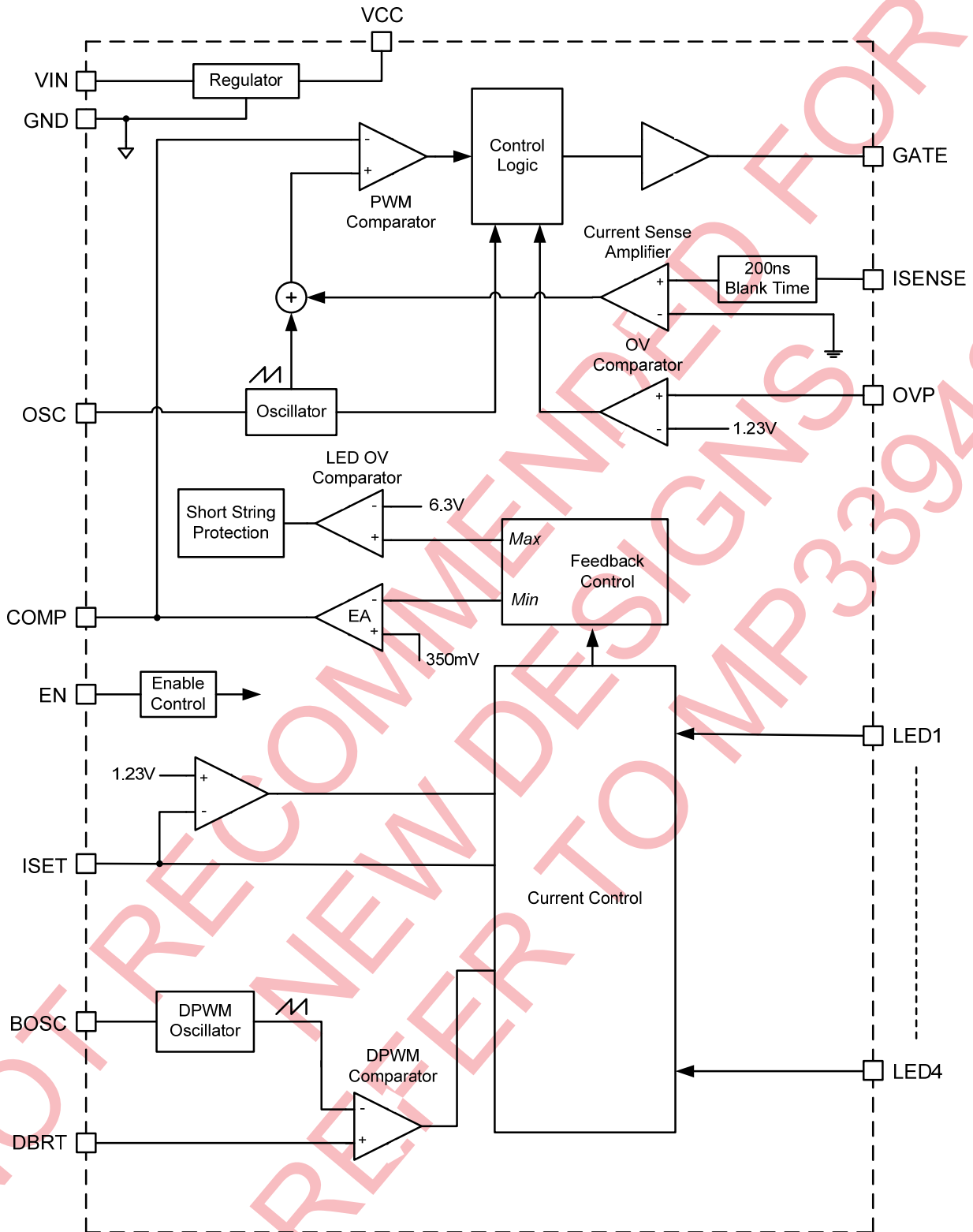

Figure 1—MP3394 Function Block Diagram

OPERATION

The MP3394 employs a programmable constant frequency, peak current mode step-up converter and 4-channels regulated current sources to drive the array of 4 strings white LEDs. The operation of the MP3394 can be understood by referring to the block diagram of Figure 1.

Internal 6V Regulator

The MP3394 includes an internal linear regulator (VCC). When VIN is greater than 6.5V, this regulator offers a 6V power supply for the external MOSFET switch gate driver and the internal control circuitry. The VCC voltage drops to 0V when the chip shuts down. The MP3394 features Under Voltage Lockout. The chip is disabled until VCC exceeds the UVLO threshold. And the hysteresis of UVLO is approximately 200mV.

System Startup

When the MP3394 is enabled, the chip checks the topology connection first. The chip monitors the OVP pin to see if the Schottky diode is not connected or the boost output is short to GND. If the OVP voltage is lower than 70mV, the chip will be disabled. The MP3394 will also check other safety limits, including UVLO and OTP after the OVP test is passed. If they are all in function, it then starts boosting the step-up converter with an internal soft-start.

It is recommended on the start up sequence that the enable signal comes after input voltage and PWM dimming signal established.

Step-up Converter

The converter operation frequency is programmable (from 150kHz to 500kHz) with an external set resistor on OSC pin, which is helpful for optimizing the external components sizes and improving the efficiency.

At the beginning of each cycle, the external MOSFET is turned on by the internal clock. To prevent sub-harmonic oscillations at duty cycles

greater than 50 percent, a stabilizing ramp is added to the output of the current sense amplifier and the result is fed into the PWM comparator. When this result voltage reaches the output voltage of the error amplifier (V_{COMP}) the external MOSFET is turned off.

The voltage at the output of the internal error amplifier is an amplified signal of the difference between the 350mV reference voltage and the feedback voltage. The converter automatically chooses the lowest active LEDX pin voltage for providing enough bus voltage to power all the LED arrays.

If the feedback voltage drops below the 350mV reference, the output of the error amplifier increases. It results in more current flowing through the power FET, thus increasing the power delivered to the output. In this way it forms a close loop to make the output voltage in regulation.

At light-load or Vout near to Vin operation, the converter runs into the pulse-skipping mode, the FET is turned on for a minimum on-time of approximately 100ns, and then the converter discharges the power to the output in the remain period. The external MOSFET will keep off until the output voltage needs to be boosted again.

Dimming Control

The MP3394 provides two PWM dimming methods: external PWM signal or DC signal input PWM Dimming mode (see Figure 2).



Figure 2—PWM Dimming Method

When bias the BOSC pin to a DC level by a resistor, applying an external PWM signal to the DBRT pin to achieve the external PWM dimming. A DC analog signal can be directly applied to the DBRT pin to modulate the LED current with a capacitor on BOSC pin. And the DC signal is then converted to a DPWM dimming signal with the setting oscillation frequency.

The brightness of the LED array is proportional to the duty cycle of the DPWM signal. The DPWM signal frequency is set by the cap at the BOSC pin.

Open String Protection

The open string protection is achieved through detecting the voltage of OVP and LED1~4 pin. If one or more strings are open, the respective LEDX pins are pulled to ground and the IC keeps charging the output voltage until it reach OVP threshold. Then the part marks off the open strings whose LEDX pin voltage is lower than 196mV. Once the mark-off operation completes, the remaining LED strings force the output voltage back into tight regulation. The string with the highest voltage drop is the ruling string during output regulation.

The MP3394 always tries to light at least one string and if all strings are open, the MP3394 shuts down the step-up converter. The part maintains mark-off information until resetting it.

Short String Protection

The MP3394 monitors the LEDX pin voltage to judge if the short string fault occurs. If one or more strings are short, the respective LEDX pins tolerate high voltage stress. If the LEDX pin voltage is higher than 6.3V, the short string condition is detected on the respective string. When the short string fault (LEDX over-voltage fault) keeps for 2048 switching clocks, the fault string is marked off and disable. Once a string is marked off, its current regulation is forced to disconnect from the output voltage loop regulation. The marked-off LED strings will be shut off totally until the part restarts. If all strings are short, the MP3394 will shut down the step-up converter. The part maintains mark-off information until resetting it.

APPLICATION INFORMATION

Selecting the Switching Frequency

The switching frequency of the step-up converter is recommended from 150kHz to 500kHz for most of application. An oscillator resistor on OSC pin sets the internal oscillator frequency for the step-up converter according to the equation:

$$f_{sw}(kHz) = 62100 / R_{OSC} (k\Omega)$$

For $R_{OSC}=330k\Omega$, the switching frequency is set to 188 kHz.

Setting the LED Current

The LED string currents are identical and set through the current setting resistor on the ISET pin.

$$I_{LED}(mA) = 790 \times 1.23V / (R_{SET}+0.4)(k\Omega)$$

For $R_{SET}=7.68k\Omega$, the LED current is set to 120mA. The ISET pin can not be open.

Selecting the Input Capacitor

The input capacitor reduces the surge current drawn from the input supply and the switching noise from the device. The input capacitor impedance at the switching frequency should be less than the input source impedance to prevent high frequency switching current from passing through the input. Ceramic capacitors with X5R or X7R dielectrics are highly recommended because of their low ESR and small temperature coefficients. For most applications, a 4.7 μ F ceramic capacitor paralleled a 220 μ F electrolytic capacitor is sufficient.

Selecting the Inductor and Current Sensing Resistor

The inductor is required to force the higher output voltage while being driven by the input voltage. A larger value inductor results in less ripple current, resulting in lower peak inductor current and reducing stress on the internal N-Channel MOSFET. However, the larger value inductor has a larger physical size, higher series resistance, and lower saturation current.

Choose an inductor that does not saturate under the worst-case load conditions. The minimum value of inductor is selected to ensure that the boost converter works in continuous conduction mode for high efficiency and good EMI performance.

Calculate the required inductance value by the equation:

$$L \geq \frac{\eta \times V_{OUT} \times D \times (1-D)^2}{2 \times f_{SW} \times I_{LOAD}}$$

$$D = 1 - \frac{V_{IN}}{V_{OUT}}$$

Where V_{IN} and V_{OUT} is the input and output voltage, f_{SW} is the switching frequency, I_{LOAD} is the LED load current, and η is the efficiency.

The switch current is usually used for the peak current mode control. In order to avoid hitting the current limit, the voltage across the sensing resistor R_{SENSE} should be less than 80% of the worst case current limit voltage, V_{SENSE} .

$$R_{SENSE} = \frac{0.8 \times V_{SENSE}}{I_{L(PEAK)}}$$

$$I_{L(PEAK)} = \frac{V_{OUT} \times I_{LOAD}}{\eta V_{IN}} + \frac{V_{IN} \times (V_{OUT} - V_{IN})}{2 \times L \times f_{SW} \times V_{OUT}}$$

Where $I_{L(PEAK)}$ is the peak value of the inductor current. V_{SENSE} is shown in Figure 3.

Vsense vs. Duty Cycle

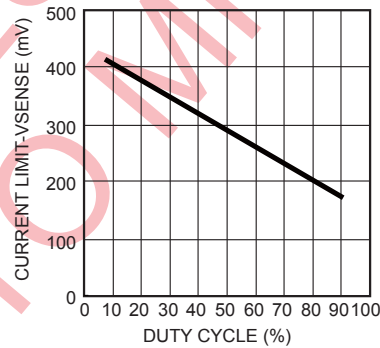

Figure 3— V_{SENSE} vs Duty Cycle

Selecting the Power MOSFET

The MP3394 is capable of driving a wide variety of N-Channel power MOSFETS. The critical parameters of selection of a MOSFET are:

1. Maximum drain to source voltage, $V_{DS(MAX)}$
2. Maximum current, $I_{D(MAX)}$
3. On-resistance, $R_{DS(ON)}$
4. Gate source charge Q_{GS} and gate drain charge Q_{GD}
5. Total gate charge, Q_G

Ideally, the off-state voltage across the MOSFET is equal to the output voltage. Considering the voltage spike when it turns off, $V_{DS(MAX)}$ should be greater than 1.5 times of the output voltage.

The maximum current through the power MOSFET happens when the input voltage is minimum and the output power is maximum. The maximum RMS current through the MOSFET is given by

$$I_{RMS(MAX)} = I_{IN(MAX)} \times \sqrt{D_{MAX}} \quad \text{Where:}$$

$$D_{MAX} \approx \frac{V_{OUT} - V_{IN(MIN)}}{V_{OUT}}$$

The current rating of the MOSFET should be greater than 1.5 times I_{RMS}

The on resistance of the MOSFET determines the conduction loss, which is given by:

$$P_{cond} = I_{RMS}^2 \times R_{DS(on)} \times k$$

Where k is the temperature coefficient of the MOSFET.

The switching loss is related to Q_{GD} and Q_{GS1} which determine the commutation time. Q_{GS1} is the charge between the threshold voltage and the plateau voltage when a driver charges the gate, which can be read in the chart of V_{GS} vs. Q_G of the MOSFET datasheet. Q_{GD} is the charge during the plateau voltage. These two parameters are needed to estimate the turn on and turn off loss.

$$P_{SW} = \frac{Q_{GS1} \times R_G}{V_{DR} - V_{TH}} \times V_{DS} \times I_{IN} \times f_{SW} +$$

$$\frac{Q_{GD} \times R_G}{V_{DR} - V_{PLT}} \times V_{DS} \times I_{IN} \times f_{SW}$$

Where V_{TH} is the threshold voltage, V_{PLT} is the plateau voltage, R_G is the gate resistance, V_{DS} is the drain-source voltage. Please note that the switching loss is the most difficult part in the loss estimation. The formula above provides a simple physical expression. If more accurate estimation is required, the expressions will be much more complex.

For extended knowledge of the power loss estimation, readers should refer to the book

“Power MOSFET Theory and Applications” written by Duncan A. Grant and John Gowar.

The total gate charge, Q_G , is used to calculate the gate drive loss. The expression is

$$P_{DR} = Q_G \times V_{DR} \times f_{SW}$$

Where V_{DR} is the drive voltage.

Selecting the Output Capacitor

The output capacitor keeps the output voltage ripple small and ensures feedback loop stability. The output capacitor impedance should be low at the switching frequency. Ceramic capacitors with X7R dielectrics are recommended for their low ESR characteristics. For most applications, a 4.7 μ F ceramic capacitor paralleled 22 μ F electrolytic capacitor will be sufficient.

Setting the Over Voltage Protection

The open string protection is achieved through detecting the voltage of OVP pin. In some cases, an LED string failure results in the feedback voltage always zero. The part then keeps boosting the output voltage higher and higher. If the output voltage reaches the programmed OVP threshold, the protection will be triggered.

To make sure the chip functions properly, the OVP setting resistor divider must be set with a proper value. The recommended OVP point is about 1.1~1.2 times higher than the output voltage for normal operation.

$$V_{OVP} = 1.23 \times \left(1 + \frac{R_{HIGH}}{R_{LOW}}\right)$$

Selecting Dimming Control Mode

The MP3394 provides 2 different dimming methods

1. Direct PWM Dimming

An external PWM dimming signal is employed to achieve PWM dimming control. Connect a 100k Ω resistor from BOSC pin to GND and apply the 100Hz to 20kHz PWM dimming signal to DBRT pin. The minimum recommended amplitude of the PWM signal is 1.2V. The low level should be less than 0.4V(See Figure 4).

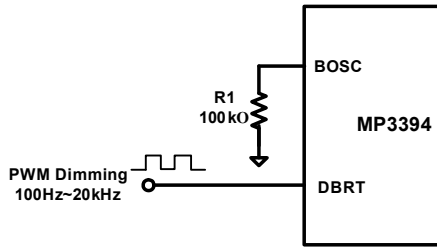

Figure 4—Direct PWM Dimming

Table 1 shows the PWM dimming duty Range with different PWM dimming frequency.

Table 1—The Range of PWM Dimming Duty

Fpwm(Hz)	Dmin	Dmax
100<f≤200	0.30%	100%
200<f≤500	0.75%	100%
500<f≤1k	1.50%	100%
1k<f≤2k	3.00%	100%
2k<f≤5k	7.50%	100%
5k<f≤10k	15.00%	100%
10k<f≤20k	30.00%	100%

2. DC Input PWM Dimming

To apply DC input PWM dimming, apply an analog signal (range from 0.2 V to 1.2V) to the DBRT pin to modulate the LED current directly. If the PWM dimming signal is applied with a lower 0.2V DC voltage, the PWM duty cycle will be 0%. If the DBRT pin is applied with a DC voltage>1.2V, the output will be 100% (See Figure 5). The capacitor on BOSC pin set the frequency of internal triangle waveform according to the equation.

$$f_{BOSC} \text{ (kHz)} = 3.5 / C_{BOSC} \text{ (nF)}$$

The dimming frequency is recommended set from 100Hz to 20kHz.

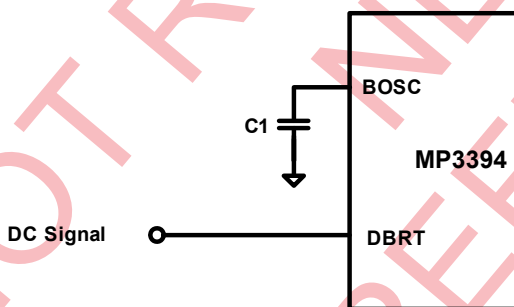

Figure 5—DC input PWM Dimming

Extending LED Channels applications

The MP3394 is flexible for extending LED channels with two or three MP3394s in parallel. For the connection of two MP3394s extending 8 strings LEDs, tie the VCC pins of the master IC and the slave IC together to provide the power of the slave IC internal logic circuitry. Also tie the COMP pins of the slave IC and the master IC together to regulate the voltage of all 8 strings LEDs. The MOS driving signals of the slave IC are not used; the boost converter can be only driven by the master IC. Do not let the Isense pin of the slave IC floating, tie it to GND. The EN and Dimming signals should be applied to both ICs. It is recommended to use external PWM dimming mode to achieve the accurate dimming synchronization of both parts.

External MOSFET for Short Protection

When output voltage is higher than rating of LED1-4 pins, external MOSFET is needed for each LED channel to avoid destroying LED1-4 pins. (See Figure 8)The rating of MOSFET must be higher than 1.2* V_{OUT} t and more than 1.2* I_{LED}.

Layout Considerations

Careful attention must be paid to the PCB board layout and components placement. Proper layout of the high frequency switching path is critical to prevent noise and electromagnetic interference problems. The loop of external MOSFET (M1), output diode (D1), and output capacitor (C2, C3) flows with high frequency pulse current. It must be as small as possible (See Figure 6).

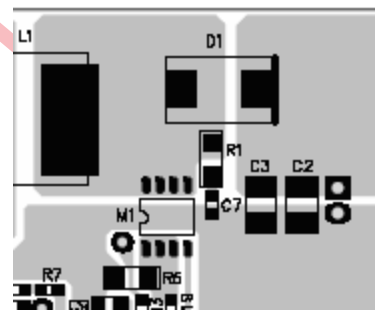

Figure 6—Layout Consideration

All logic signals and power ground are referred to the GND. The power ground should be externally connected to signal ground and is recommended to keep away from the logic signals.

TYPICAL APPLICATION CIRCUIT

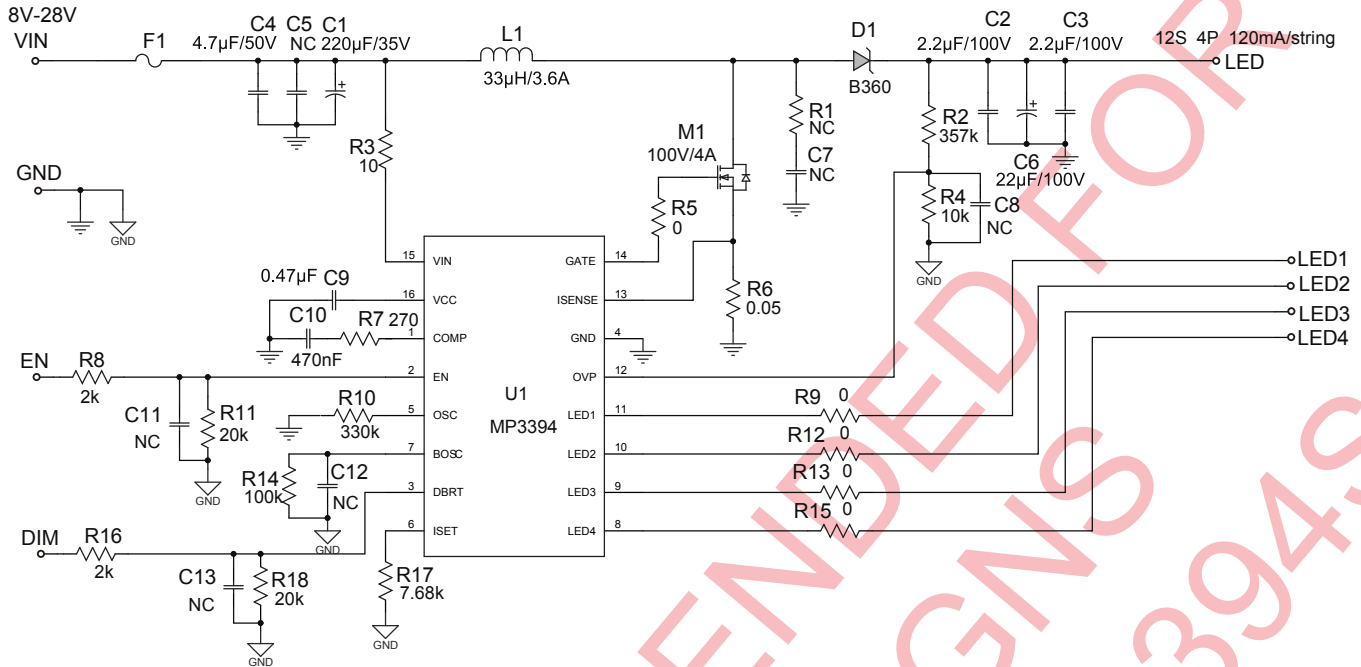

Figure 7—Drive 12 LEDs in Series, 4 Strings 120mA/String

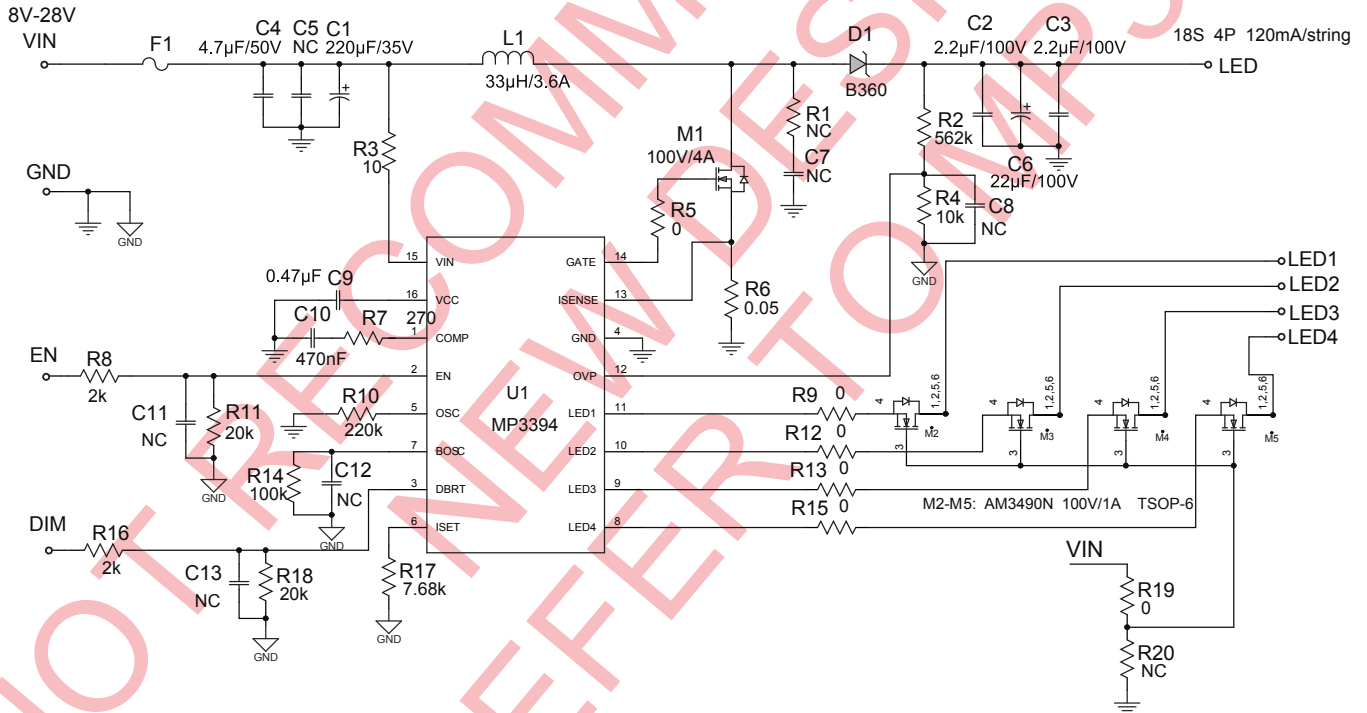
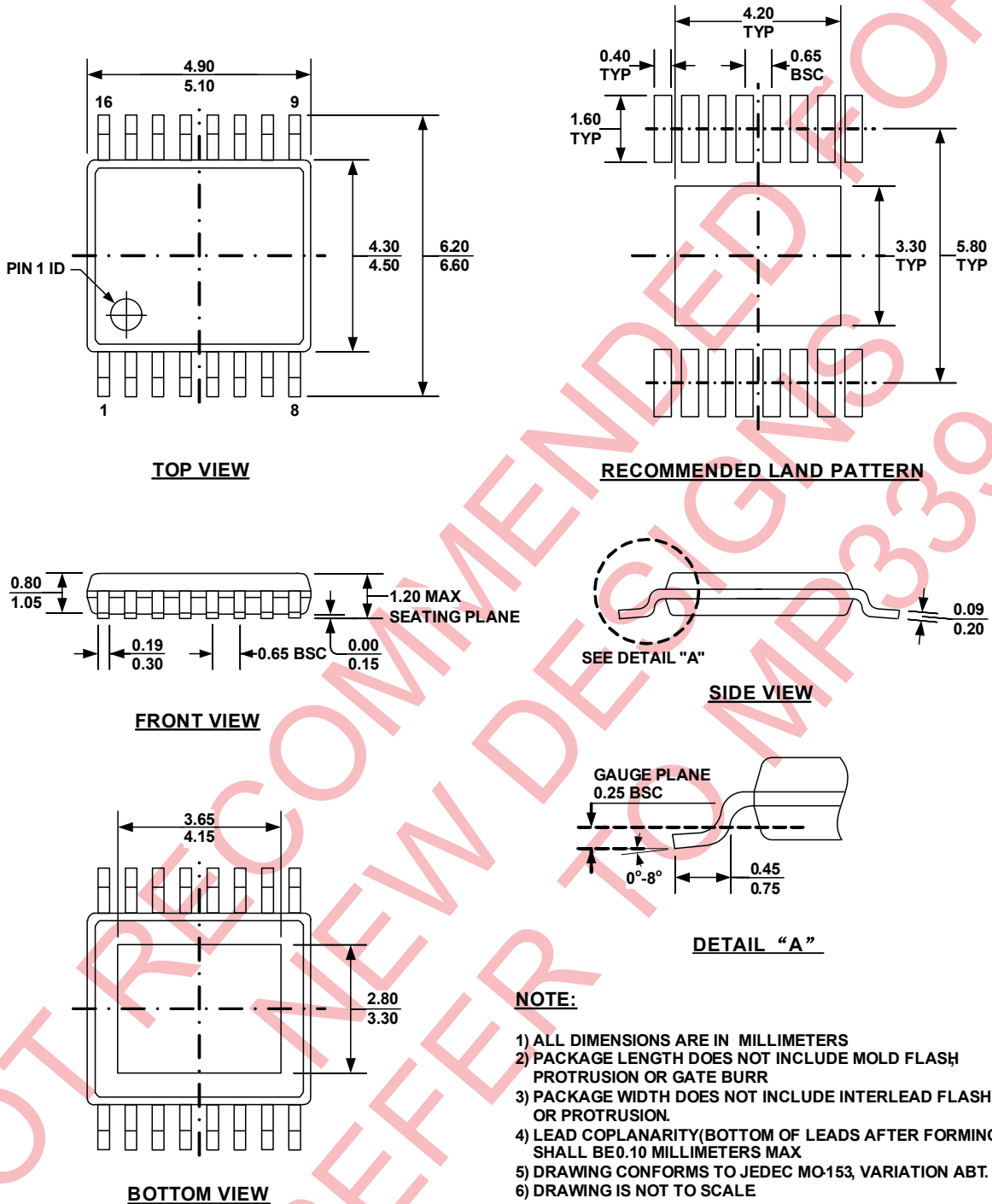

Figure 8 – Drive 18LEDs in Series, 4 strings 120mA/string

Note: For $V_{in} > 15V$ application, use R19 and R20(10k Ω) divider to make a 15V bias voltage for M2-M5.

PACKAGE INFORMATION

TSSOP16 (with external thermal pad)



SOIC16

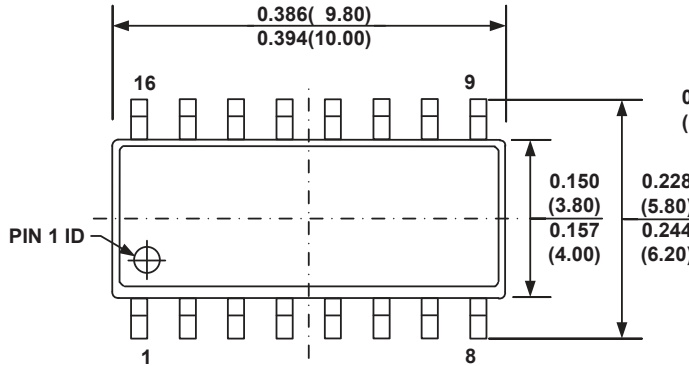

TOP VIEW

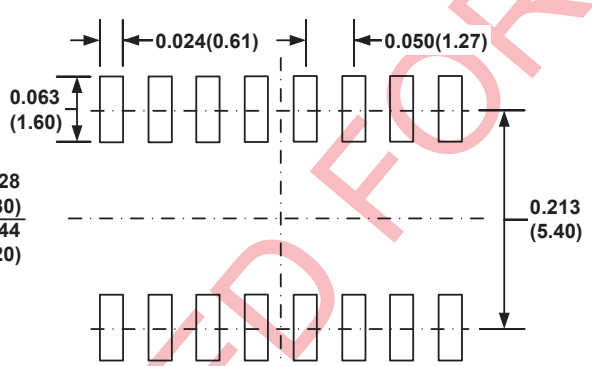

RECOMMENDED LAND PATTERN

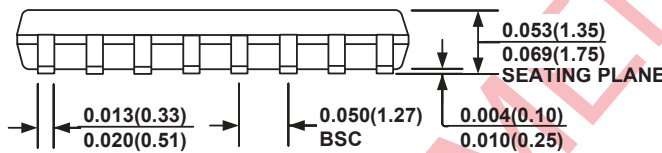

FRONT VIEW

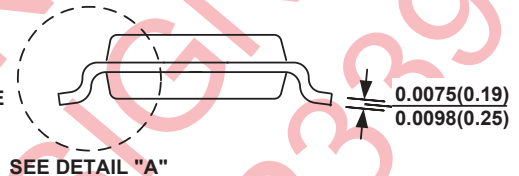

SIDE VIEW

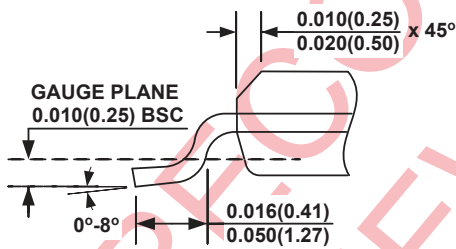

DETAIL "A"

NOTE:

- 1) CONTROL DIMENSION IS IN INCHES. DIMENSION IN BRACKET IS IN MILLIMETERS.
- 2) PACKAGE LENGTH DOES NOT INCLUDE MOLD FLASH, PROTRUSIONS OR GATE BURRS.
- 3) PACKAGE WIDTH DOES NOT INCLUDE INTERLEAD FLASH OR PROTRUSIONS.
- 4) LEAD COPLANARITY (BOTTOM OF LEADS AFTER FORMING) SHALL BE 0.004" INCHES MAX.
- 5) DRAWING CONFORMS TO JEDEC MS-012, VARIATION AC.
- 6) DRAWING IS NOT TO SCALE.

SOIC20

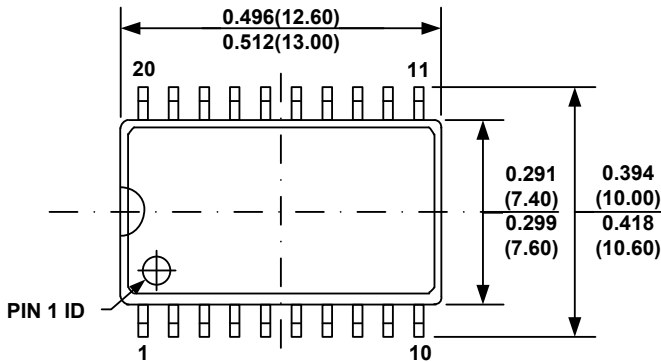

TOP VIEW

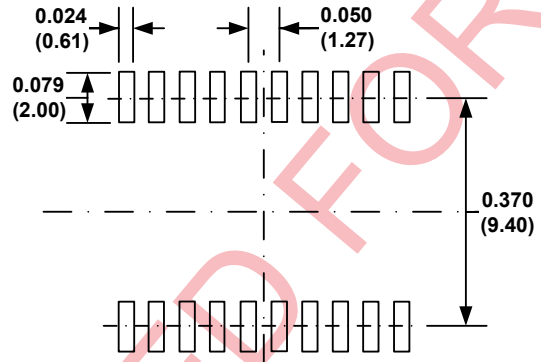

RECOMMENDED LAND PATTERN

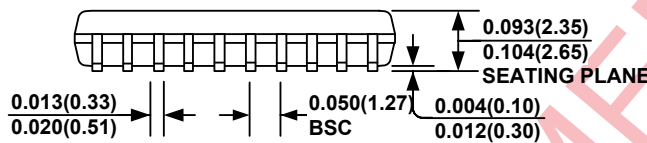

FRONT VIEW

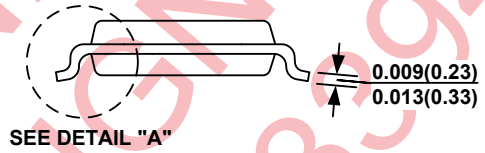

SIDE VIEW

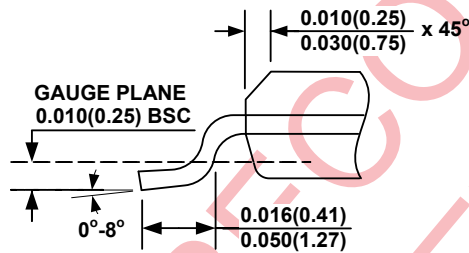

DETAIL "A"

NOTE:

- 1) CONTROL DIMENSION IS IN INCHES. DIMENSION IN BRACKET IS IN MILLIMETERS.
- 2) PACKAGE LENGTH DOES NOT INCLUDE MOLD FLASH, PROTRUSIONS OR GATE BURRS.
- 3) PACKAGE WIDTH DOES NOT INCLUDE INTERLEAD FLASH OR PROTRUSIONS.
- 4) LEAD COPLANARITY (BOTTOM OF LEADS AFTER FORMING) SHALL BE 0.10 MILLIMETERS MAX.
- 5) DRAWING CONFORMS TO JEDEC MS-013, VARIATION AC.
- 6) DRAWING IS NOT TO SCALE.

NOTICE: The information in this document is subject to change without notice. Users should warrant and guarantee that third party Intellectual Property rights are not infringed upon when integrating MPS products into any application. MPS will not assume any legal responsibility for any said applications.



Компания «ЭлектроПласт» предлагает заключение долгосрочных отношений при поставках импортных электронных компонентов на взаимовыгодных условиях!

Наши преимущества:

- Оперативные поставки широкого спектра электронных компонентов отечественного и импортного производства напрямую от производителей и с крупнейших мировых складов;
- Поставка более 17-ти миллионов наименований электронных компонентов;
- Поставка сложных, дефицитных, либо снятых с производства позиций;
- Оперативные сроки поставки под заказ (от 5 рабочих дней);
- Экспресс доставка в любую точку России;
- Техническая поддержка проекта, помощь в подборе аналогов, поставка прототипов;
- Система менеджмента качества сертифицирована по Международному стандарту ISO 9001;
- Лицензия ФСБ на осуществление работ с использованием сведений, составляющих государственную тайну;
- Поставка специализированных компонентов (Xilinx, Altera, Analog Devices, Intersil, Interpoint, Microsemi, Aeroflex, Peregrine, Syfer, Eurofarad, Texas Instrument, Miteq, Cobham, E2V, MA-COM, Hittite, Mini-Circuits, General Dynamics и др.);

Помимо этого, одним из направлений компании «ЭлектроПласт» является направление «Источники питания». Мы предлагаем Вам помощь Конструкторского отдела:

- Подбор оптимального решения, техническое обоснование при выборе компонента;
- Подбор аналогов;
- Консультации по применению компонента;
- Поставка образцов и прототипов;
- Техническая поддержка проекта;
- Защита от снятия компонента с производства.



Как с нами связаться

Телефон: 8 (812) 309 58 32 (многоканальный)

Факс: 8 (812) 320-02-42

Электронная почта: org@eplast1.ru

Адрес: 198099, г. Санкт-Петербург, ул. Калинина, дом 2, корпус 4, литера А.