

Coil type EMI Filters (Digital Noise Filters)

Discontinued

Type: ELKE□



Features

- 3218 case size, 6 A rated current (ELKEA) and 2 A rated current (ELKE)
- High ESD suppression with varistor and included coils
- No variation in attenuation characteristics due to current changes
- Easily discernible part number written by lasers
- RoHS compliant

Recommended Applications

- Data lines, secondary power supply lines (DC lines) for game, digital AV and communications equipment.

Explanation of Part Numbers

[ELKE, ELKEA Series]



[ELKEV Series]

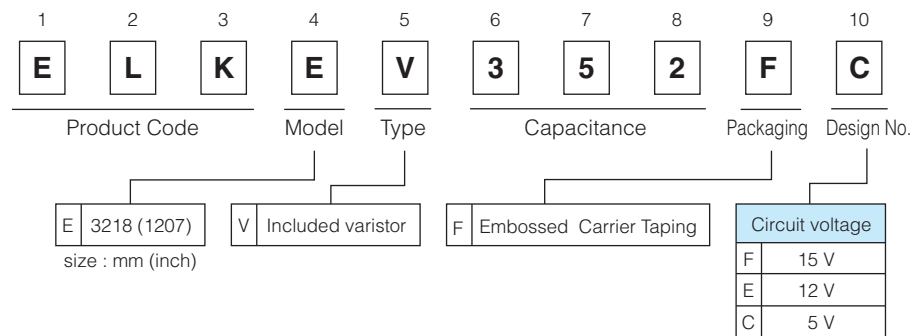

Construction



No.	Part Name	Material
1	Enclosure	PPS resin mixed with ferrite powder
2	Coil	Copper alloy plate
3	Terminal	Copper alloy plate with SnCu
4	Capacitor	Chip capacitor

Large Current Coil type EMI Filters (Digital Noise Filters)

SMD

Type: **ELKEA**

Discontinued



Features

- 3218 case size, 6 A rated current
- No variation in attenuation characteristics due to current changes
- Easily discernible part number written by lasers
- RoHS compliant

Typical Specification

- Operating temperature : -40 to +85 °C
- Rated Voltage : DC 50 V (Except ELKEA333FA : DC25 V)
- Rated Current : DC 6 A

Standard Parts

Part No.	Cut off frequency (MHz)	Inner Capacitance (pF typ.)	Rated Voltage (V)	Rated Current (A)	Indication		min. Packaging
					Indication 1	Indication 2	
ELKEA100FA	500	10	50	6.0	100□	Indication 2	2,000 pcs.
ELKEA220FA	300	22			220□		
ELKEA470FA	150	47			470□		
ELKEA101FA	70	100			101□		
ELKEA221FA	30	220			221□		
ELKEA471FA	15	470			471□		
ELKEA102FA	7	1000			102□		
ELKEA222FA	3	2200			222□		
ELKEA103FA	0.5/DC	10000			103□		
ELKEA333FA	0.2/DC	33000	25	333□	Indication 2		

note1 : 4th letter (□) of marking indicates the Month Code.
 note2 : Indication 1, 2 refer to Indication examples.

Performance characteristics (Reference)



Equivalent circuit, measurement block diagram

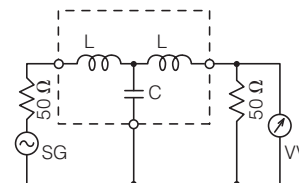

Indication Examples

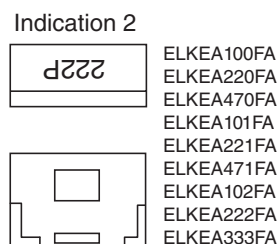
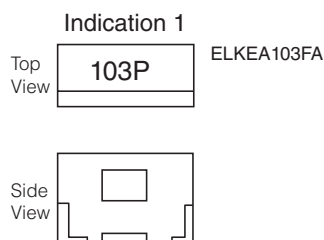

Coil type EMI Filters (Digital Noise Filters)

SMD

Type: **ELKE**

Discontinued



Features

- 3218 case size, 2 A rated current
- No variation in attenuation characteristics due to current changes
- Easily discernible part number written by lasers
- RoHS compliant

Typical Specification

- Operating temperature : -40 to +85 °C
- Rated Voltage : DC 50 V (Except ELKE333FA : DC25 V)
- Rated Current : DC 2 A

Standard Parts

Part No.	Cut off frequency (MHz)	Inner Capacitance (pF typ.)	Rated Voltage (V)	Rated Current (A)	Indication	min. Packaging unit
ELKE100FA	250	10	50	2.0	100□	2,000 pcs.
ELKE220FA	200	22			220□	
ELKE470FA	100	47			470□	
ELKE101FA	50	100			101□	
ELKE221FA	25	220			221□	
ELKE471FA	10	470			471□	
ELKE102FA	5	1000			102□	
ELKE222FA	2	2200			222□	
ELKE103FA	0.5/DC	10000			103□	
ELKE333FA	0.2/DC	33000			25	

note1 : 4th letter (□) of marking indicates the Month Code.

Performance characteristics (Reference)



Equivalent circuit, measurement block diagram



Indication Examples



(Top View)



(Side View)

1 0 3 P

Month Code : 1 Letter

Inner Capacitance : 3 Letters

Varistor included Coil type EMI Filters (Digital Noise Filters)



SMD

Type: **ELKEV**

Discontinued

Features

- High ESD suppression with varistor and included coils
- No variation in attenuation characteristics due to current changes
- Easily discernible part number written by lasers
- RoHS compliant

Typical Specification

- Operating temperature : -40 to +85 °C
- Rated Voltage : Applicable normal voltage for varistor
- Rated Current : DC 2 A

Standard Parts

Part No.	Cut off frequency (MHz)	Inner Capacitance (pF typ.)	Rated Voltage (V)	Applicable circuit voltage (V max.)	Indication		min. Packaging
					Part No.	Value	
ELKEV150FF	250	15	27	15	2.0	150□	2,000 pcs.
ELKEV300FF	200	30	27	15		300□	
ELKEV161FF	50	160	27	15		161□	
ELKEV431FF	20	430	27	15		431□	
ELKEV561FE	10	560	22	12		561□	
ELKEV112FC	8	1050	12	5		112□	
ELKEV352FC	1/DC	3500	12	5		352□	

Note1 : 4th letter (□) of marking indicates the Month Code.

Performance characteristics (Reference)

Equivalent circuit, measurement block diagram

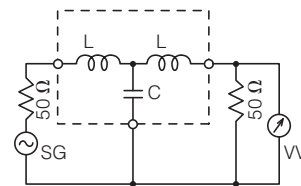
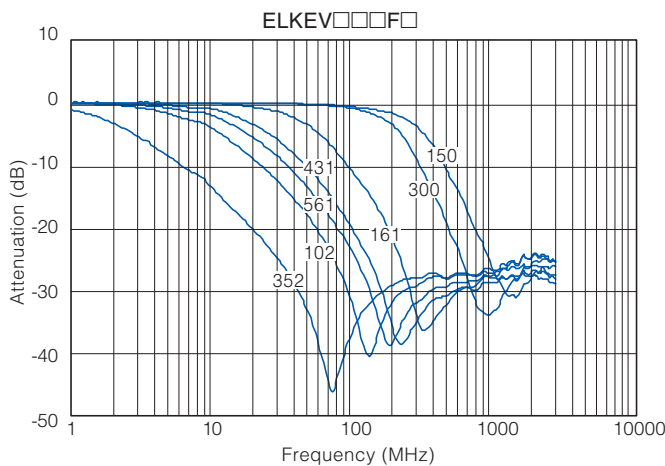

Indication Examples

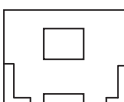
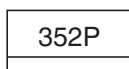

3 5 2 P

Month Code : 1 Letter

Inner Capacitance : 3 Letters

Dimensions in mm (not to scale)

Land Pattern in mm (not to scale)



Packaging state



Reel Size : $\phi 178$
 Q'ty : 2,000 pcs./reel
 Packaging : Embossed Carrier Taping

Soldering conditions for reflow



Storage Conditions

- Package : Normal temperature (-5 to 35 °C), normal humidity (85 %RH max.), shall not be exposed to direct sunlight and harmful gases and care should be taken so as not to cause dew.
- Operating Temperature : -40 to +85 °C

Storage Period

- Solderability may be reduced due to the conditions of high temperature and high humidity which causes the oxidation of tin-plated terminals. Even if storage conditions are within specified limits, solderability may be reduced with time. Therefore, please control the storage conditions and use the product within 6 months of receipt.

⚠ Safety Precautions

The following are precautions for individual products. Please also refer to the common precautions for EMC Components in this catalog.

1. Operation range and environments

- ① These products are designed and manufactured for general and standard use in general electronic equipment (e.g. AV equipment, home electric appliances, office equipment, information and communication equipment)
- ② These products are not intended for use in the following special conditions. Before using the products, carefully check the effects on their quality and performance, and determine whether or not they can be used.
 - In liquid, such as water, oil, chemicals, or organic solvent
 - In direct sunlight, outdoors, or in dust
 - In salty air or air with a high concentration of corrosive gas, such as Cl₂, H₂S, NH₃, SO₂, or NO₂
 - In an environment where these products cause dew condensation

2. Handling

- ① Do not bring magnets or magnetized materials close to the product. The influence of their magnetic field can change the inductance value.
- ② Do not apply strong mechanical shocks by either dropping or collision with other parts.
Excessive shock can damage the part.

3. Land pattern design

- ① Please refer to the recommended land pattern for each type shown on the datasheet.
- ② In case of reflow soldering, consider the layout because taller components close to EMI filters tend to block thermal conduction.

4. Mounting

- ① Avoid excessive placement force.
- ② Do not bend or twist the PWB after mounting the part.

5. Cleaning

- ① Do not use acid or alkali agents. Some cleaning solvents may damage the part.
Confirm by testing the reliability in advance of mass production.
- ② If Ultrasonic cleaning is used, please confirm the reliability in advance.
It is possible that combined resonance of component, PWB and cavitation can cause an abnormal vibration mode to exist causing damage.

⚠ Safety Precautions (Common precautions for EMC Components and ESD Suppressor)

- When using our products, no matter what sort of equipment they might be used for, be sure to make a written agreement on the specifications with us in advance. The design and specifications in this catalog are subject to change without prior notice.
- Do not use the products beyond the specifications described in this catalog.
- This catalog explains the quality and performance of the products as individual components. Before use, check and evaluate their operations when installed in your products.
- Install the following systems for a failsafe design to ensure safety if these products are to be used in equipment where a defect in these products may cause the loss of human life or other significant damage, such as damage to vehicles (automobile, train, vessel), traffic lights, medical equipment, aerospace equipment, electric heating appliances, combustion/gas equipment, rotating equipment, and disaster/crime prevention equipment.
- * Systems equipped with a protection circuit and a protection device
- * Systems equipped with a redundant circuit or other system to prevent an unsafe status in the event of a single fault

(1) Precautions for use

- These products are designed and manufactured for general and standard use in general electronic equipment (e.g. AV equipment, home electric appliances, office equipment, information and communication equipment)
- These products are not intended for use in the following special conditions. Before using the products, carefully check the effects on their quality and performance, and determine whether or not they can be used.
 1. In liquid, such as water, oil, chemicals, or organic solvent
 2. In direct sunlight, outdoors, or in dust
 3. In salty air or air with a high concentration of corrosive gas, such as Cl₂, H₂S, NH₃, SO₂, or NO₂
 4. Electric Static Discharge (ESD) Environment (except ESD Suppressors)
These components are sensitive to static electricity and can be damaged under static shock (ESD). Please take measures to avoid any of these environments.
Smaller components are more sensitive to ESD environment.
 5. Electromagnetic Environment
Avoid any environment where strong electromagnetic waves exist.
 6. In an environment where these products cause dew condensation
 7. Sealing or coating of these products or a printed circuit board on which these products are mounted, with resin or other materials
- These products generate Joule heat when energized. Carefully position these products so that their heat will not affect the other components.
- Carefully position these products so that their temperatures will not exceed the category temperature range due to the effects of neighboring heat-generating components. Do not mount or place heat-generating components or inflammables, such as vinyl-coated wires, near these products.
- Note that non-cleaning solder, halogen-based highly active flux, or water-soluble flux may deteriorate the performance or reliability of the products.
- Carefully select a flux cleaning agent for use after soldering. An unsuitable agent may deteriorate the performance or reliability. In particular, when using water or a water-soluble cleaning agent, be careful not to leave water residues. Otherwise, the insulation performance may be deteriorated.

(2) Precautions for storage

- Do not store these products in the following conditions. Otherwise, their electrical performance and/or solderability may be deteriorated, and the packaging materials (e.g. taping materials) may be deformed or deteriorated, resulting in mounting failures.
 1. In salty air or in air with a high concentration of corrosive gas, such as Cl₂, H₂S, NH₃, SO₂, or NO₂
 2. In direct sunlight

<Package markings>

Package markings include the product number, quantity, and country of origin. In principle, the country of origin should be indicated in English.

Mouser Electronics

Authorized Distributor

Click to View Pricing, Inventory, Delivery & Lifecycle Information:

Panasonic:

[ELK-E102FA](#) [ELK-E101FA](#) [ELK-E103FA](#) [ELK-E222FA](#) [ELK-E471FA](#) [ELK-E100FA](#) [ELK-E220FA](#) [ELK-E221FA](#)
[ELK-E333FA](#) [ELK-E470FA](#) [ELK-EA100FA](#) [ELK-EA101FA](#) [ELK-EA102FA](#) [ELK-EA103FA](#) [ELK-EA220FA](#) [ELK-](#)
[EA221FA](#) [ELK-EA222FA](#) [ELK-EA333FA](#) [ELK-EA470FA](#) [ELK-EA471FA](#) [ELK-EV112FC](#) [ELK-EV150FF](#) [ELK-](#)
[EV161FF](#) [ELK-EV300FF](#) [ELK-EV352FC](#) [ELK-EV431FF](#) [ELK-EV561FE](#)



Компания «ЭлектроПласт» предлагает заключение долгосрочных отношений при поставках импортных электронных компонентов на взаимовыгодных условиях!

Наши преимущества:

- Оперативные поставки широкого спектра электронных компонентов отечественного и импортного производства напрямую от производителей и с крупнейших мировых складов;
- Поставка более 17-ти миллионов наименований электронных компонентов;
- Поставка сложных, дефицитных, либо снятых с производства позиций;
- Оперативные сроки поставки под заказ (от 5 рабочих дней);
- Экспресс доставка в любую точку России;
- Техническая поддержка проекта, помощь в подборе аналогов, поставка прототипов;
- Система менеджмента качества сертифицирована по Международному стандарту ISO 9001;
- Лицензия ФСБ на осуществление работ с использованием сведений, составляющих государственную тайну;
- Поставка специализированных компонентов (Xilinx, Altera, Analog Devices, Intersil, Interpoint, Microsemi, Aeroflex, Peregrine, Syfer, Eurofarad, Texas Instrument, Miteq, Cobham, E2V, MA-COM, Hittite, Mini-Circuits, General Dynamics и др.);

Помимо этого, одним из направлений компании «ЭлектроПласт» является направление «Источники питания». Мы предлагаем Вам помощь Конструкторского отдела:

- Подбор оптимального решения, техническое обоснование при выборе компонента;
- Подбор аналогов;
- Консультации по применению компонента;
- Поставка образцов и прототипов;
- Техническая поддержка проекта;
- Защита от снятия компонента с производства.



Как с нами связаться

Телефон: 8 (812) 309 58 32 (многоканальный)

Факс: 8 (812) 320-02-42

Электронная почта: org@eplast1.ru

Адрес: 198099, г. Санкт-Петербург, ул. Калинина, дом 2, корпус 4, литера А.