



InGaP HBT 1/2 WATT HIGH IP3 AMPLIFIER, 0.4 - 2.5 GHz

Typical Applications

The HMC454ST89 / HMC454ST89E is ideal for applications requiring a high dynamic range amplifier:

- GSM, GPRS & EDGE
- CDMA & W-CDMA
- CATV/Cable Modem
- Fixed Wireless & WLL

Features

- Output IP3: +40 to +42 dBm
- Gain: 12.5 dB @ 2150 MHz
- 50% PAE @ +28 dBm Pout
- +17.5 dBm W-CDMA Channel Power @ -45 dBc ACP
- Single +5V Supply
- Industry Standard SOT89 Package
- Included in the HMC-DK002 Designer's Kit

Functional Diagram



General Description

The HMC454ST89 & HMC454ST89E are high dynamic range GaAs InGaP Heterojunction Bipolar Transistor (HBT) 1/2 watt MMIC amplifiers operating between 0.4 and 2.5 GHz. Packaged in a low cost industry standard SOT89, the amplifier gain is typically 17.8 dB from 0.8 to 1.0 GHz and 12.5 dB from 1.8 to 2.2 GHz. Utilizing a minimum number of external components and a single +5V supply, the amplifier output IP3 can be optimized to +40 dBm at 0.9 GHz or +42 dBm at 2.0 GHz. The high output IP3 and PAE makes the HMC454ST89 an ideal driver amplifier for Cellular/PCS/3G, WLL, ISM and Fixed Wireless applications.

Electrical Specifications, $T_A = +25^\circ\text{C}$, $V_S = +5\text{V}$ [1]

Parameter	Min.	Typ.	Max.	Min.	Typ.	Max.	Min.	Typ.	Max.	Units
Frequency Range	824 - 960			1800 - 2000			2000 - 2200			MHz
Gain	16	17.8		11	12.5		11	12.5		dB
Gain Variation Over Temperature		0.008	0.016		0.008	0.016		0.008	0.016	dB / °C
Input Return Loss		9			7			12		dB
Output Return Loss		13			21			19		dB
Output Power for 1dB Compression (P1dB)	22	24.5		24	27		24	27.5		dBm
Saturated Output Power (Psat)		25.5			28.5			28.5		dBm
Output Third Order Intercept (IP3) [2]	37	40		38	41		38	42		dBm
Noise Figure		8			6.5			5.2		dB
Supply Current (Icq)		150	175		150	175		150	175	mA

[1] Specifications and data reflect HMC454ST89 measured using the respective application circuits for each designated frequency band found herein. Contact the HMC Applications Group for assistance in optimizing performance for your application.

[2] Two-tone input power of 0 dBm per tone, 1 MHz spacing.

**InGaP HBT 1/2 WATT HIGH IP3
AMPLIFIER, 0.4 - 2.5 GHz**



**Broadband Gain
& Return Loss @ 900 MHz**

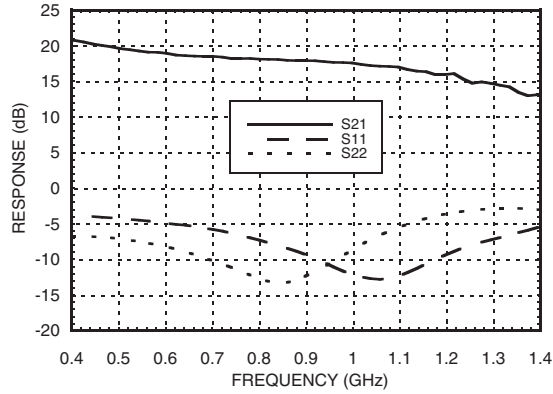

Gain vs. Temperature @ 900 MHz

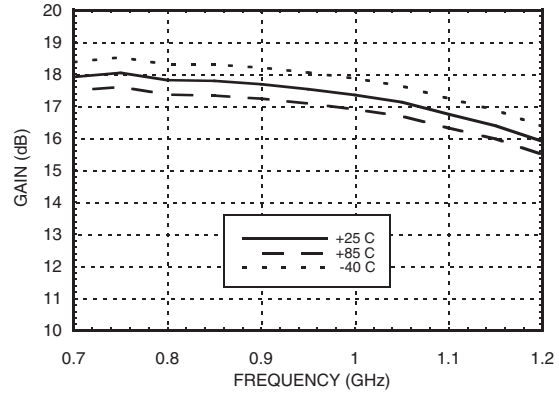

**Input Return Loss
vs. Temperature @ 900 MHz**

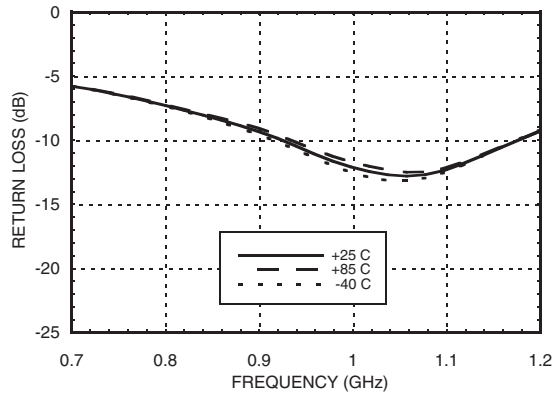

**Output Return Loss
vs. Temperature @ 900 MHz**

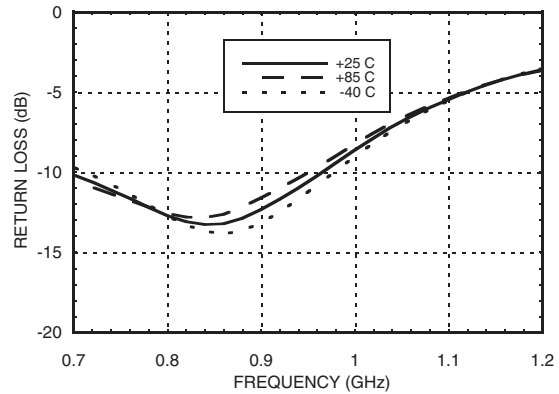

P1dB vs. Temperature @ 900 MHz

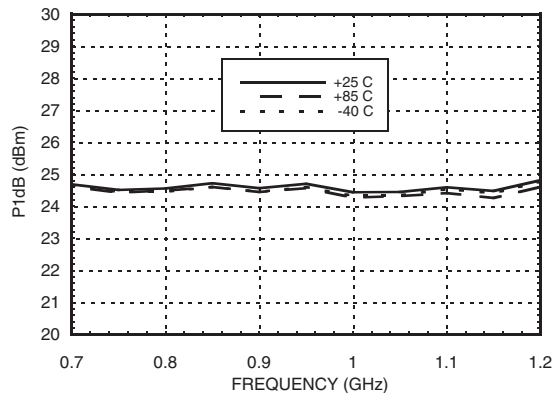

Psat vs. Temperature @ 900 MHz

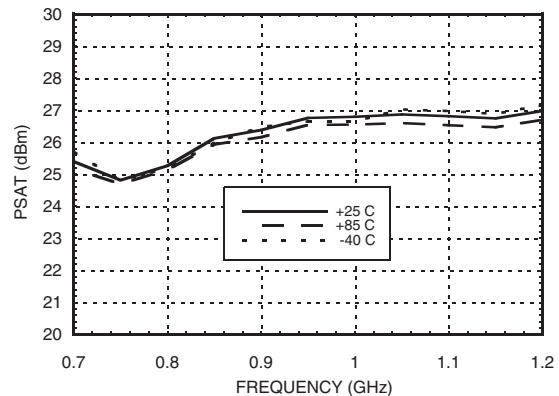

Information furnished by Analog Devices is believed to be accurate and reliable. However, no responsibility is assumed by Analog Devices for its use, nor for any infringements of patents or other rights of third parties that may result from its use. Specifications subject to change without notice. No license is granted by implication or otherwise under any patent or patent rights of Analog Devices. Trademarks and registered trademarks are the property of their respective owners.

For price, delivery, and to place orders: Analog Devices, Inc., One Technology Way, P.O. Box 9106, Norwood, MA 02062-9106 Phone: 781-329-4700 • Order online at www.analog.com Application Support: Phone: 1-800-ANALOG-D

**InGaP HBT 1/2 WATT HIGH IP3
AMPLIFIER, 0.4 - 2.5 GHz**



Output IP3 vs. Temperature @ 900 MHz

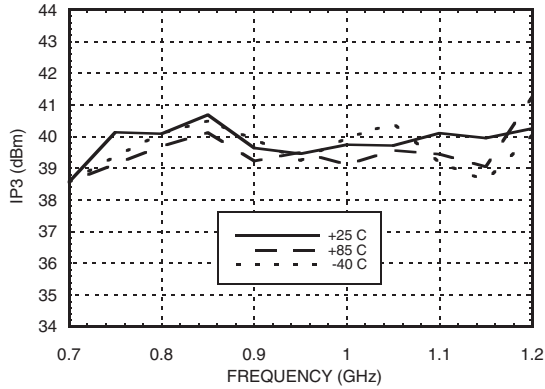

Noise Figure vs. Temperature @ 900 MHz

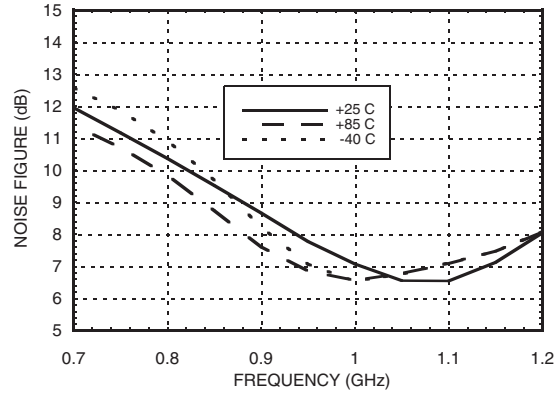

Reverse Isolation vs. Temperature @ 900 MHz

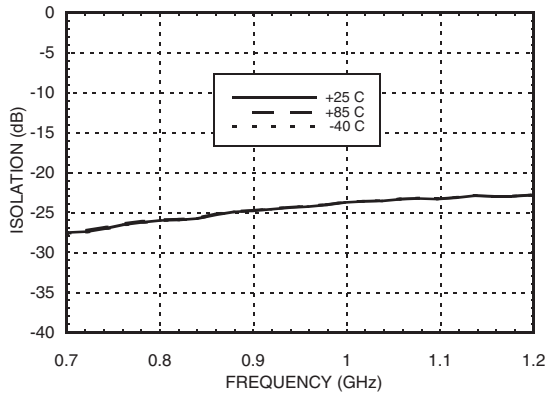

Gain, Power & Output IP3 vs. Supply Voltage @ 900 MHz



**ACPR vs. Supply Voltage @ 880 MHz
CDMA IS95, 9 Channels Forward**

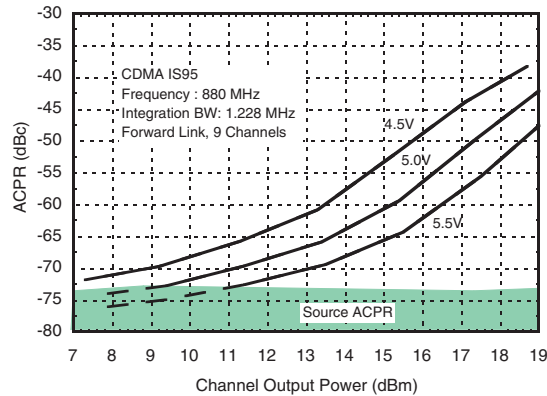



**Broadband Gain
& Return Loss @ 1960 MHz**

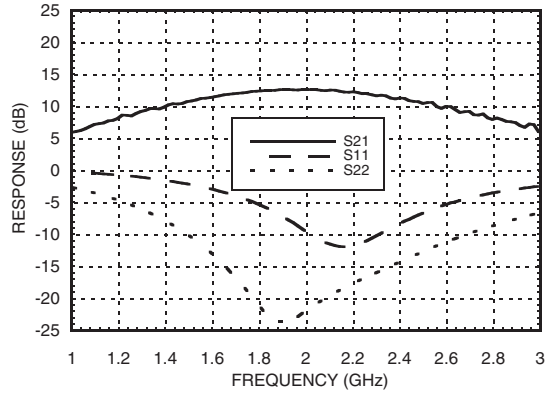

Gain vs. Temperature @ 1960 MHz

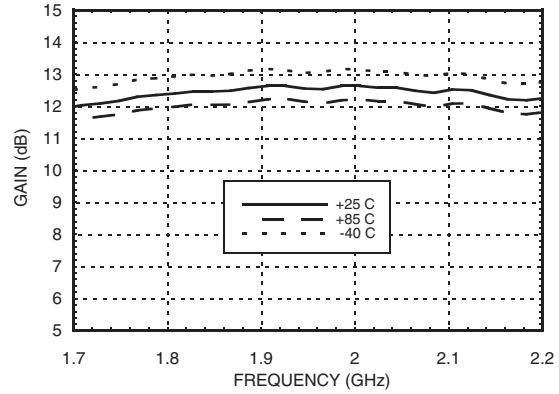

**Input Return Loss
vs. Temperature @ 1960 MHz**

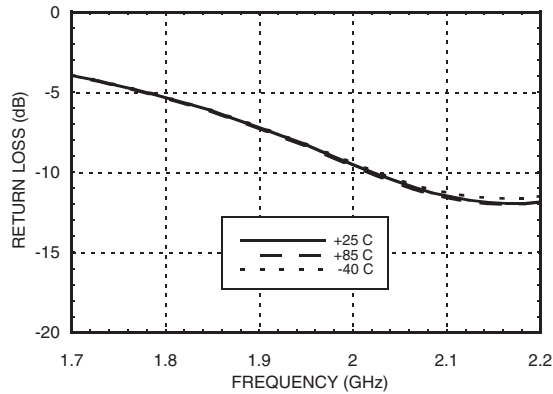

**Output Return Loss
vs. Temperature @ 1960 MHz**

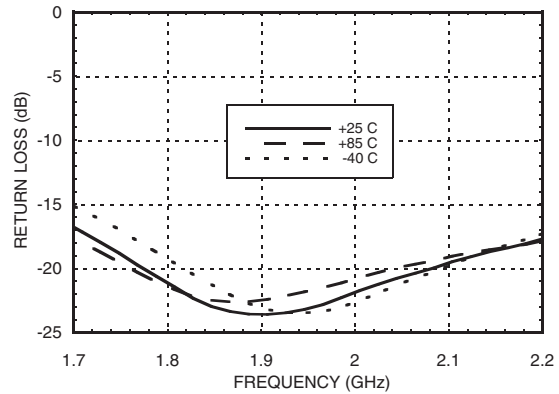

P1dB vs. Temperature @ 1960 MHz

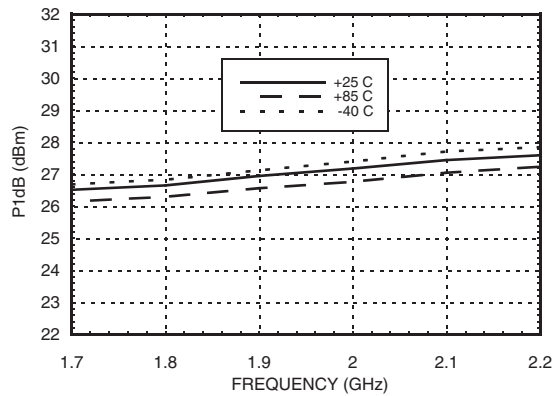

Psat vs. Temperature @ 1960 MHz

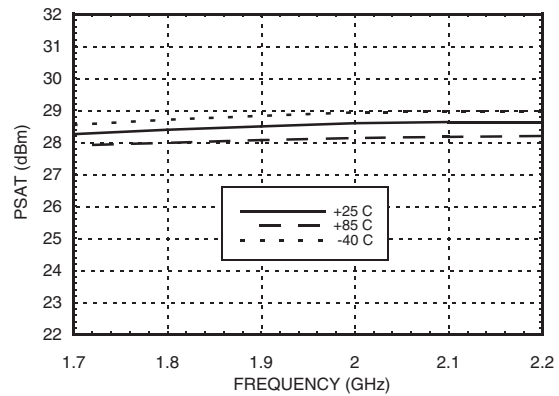

Information furnished by Analog Devices is believed to be accurate and reliable. However, no responsibility is assumed by Analog Devices for its use, nor for any infringements of patents or other rights of third parties that may result from its use. Specifications subject to change without notice. No license is granted by implication or otherwise under any patent or patent rights of Analog Devices. Trademarks and registered trademarks are the property of their respective owners.

For price, delivery, and to place orders: Analog Devices, Inc., One Technology Way, P.O. Box 9106, Norwood, MA 02062-9106 Phone: 781-329-4700 • Order online at www.analog.com Application Support: Phone: 1-800-ANALOG-D



Output IP3 vs. Temperature @ 1960 MHz

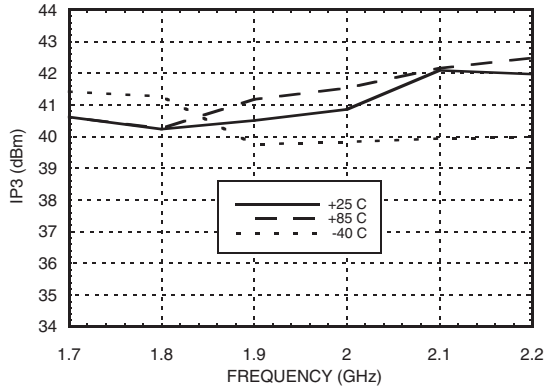

Noise Figure vs. Temperature @ 1960 MHz

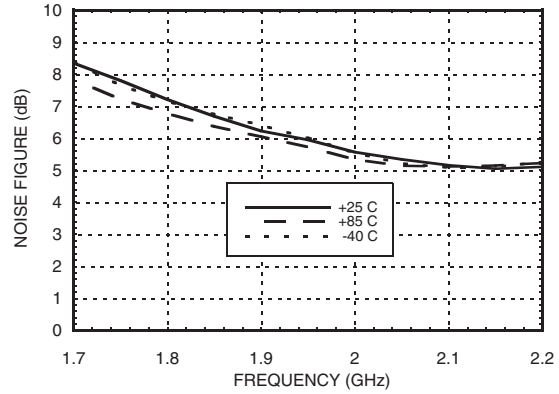

Reverse Isolation vs. Temperature @ 1960 MHz

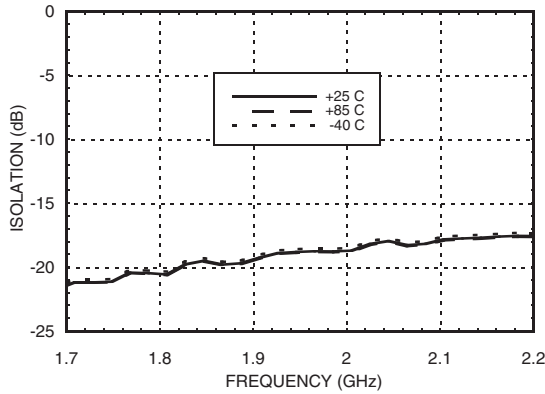

Gain, Power & Output IP3 vs. Supply Voltage @ 1960 MHz

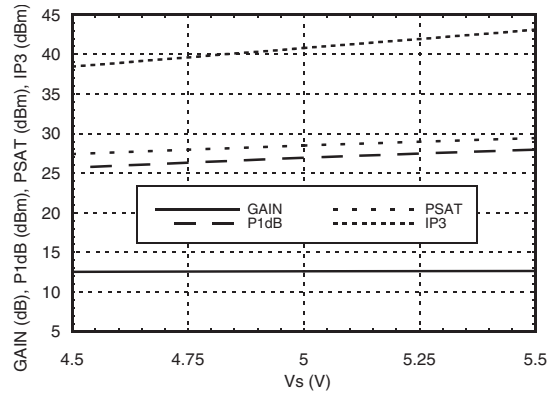

**ACPR vs. Supply Voltage @ 1.96 GHz
CDMA 2000, 9 Channels Forward**

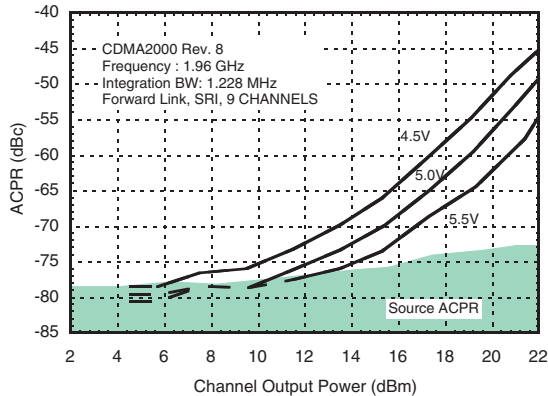

**ACPR vs. Supply Voltage @ 2.14 GHz
W-CDMA, 64 DPCH**

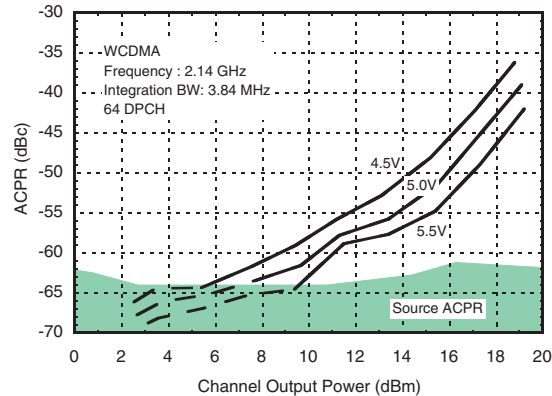



Absolute Maximum Ratings

Collector Bias Voltage (Vcc)	+6.0 Vdc
RF Input Power (RFIN)(Vs = +5Vdc)	+25 dBm
Junction Temperature	150 °C
Continuous P _{diss} (T = 85 °C) (derate 13.6 mW/°C above 85 °C)	0.890 W
Thermal Resistance (junction to ground paddle)	73 °C/W
Storage Temperature	-65 to +150 °C
Operating Temperature	-40 to +85 °C



**ELECTROSTATIC SENSITIVE DEVICE
OBSERVE HANDLING PRECAUTIONS**

9

Outline Drawing

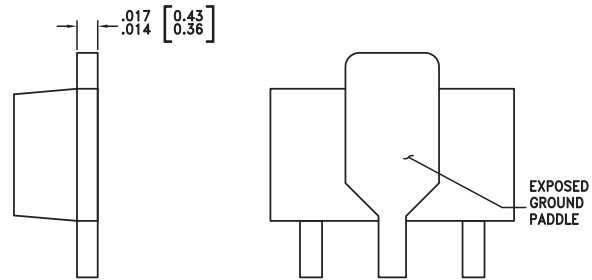
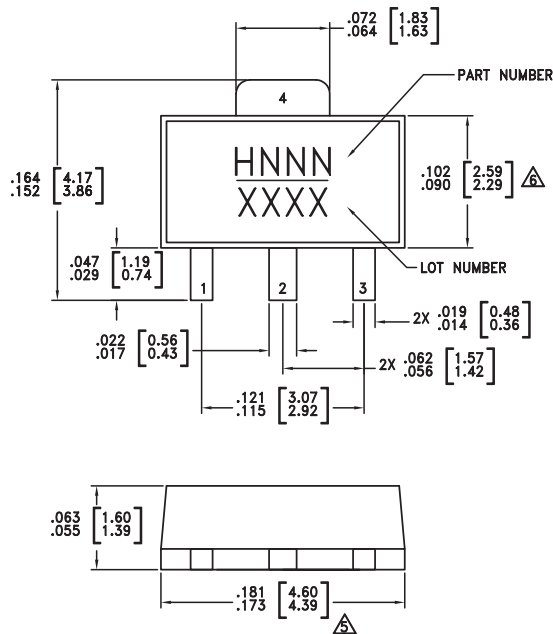

NOTES:

1. LEADFRAME MATERIAL: COPPER ALLOY
2. DIMENSIONS ARE IN INCHES [MILLIMETERS].
- △ DIMENSION DOES NOT INCLUDE MOLDFLASH OF 0.15mm PER SIDE.
- △ DIMENSION DOES NOT INCLUDE MOLDFLASH OF 0.25mm PER SIDE.
5. ALL GROUND LEADS MUST BE SOLDERED TO PCB RF GROUND.

Package Information

Part Number	Package Body Material	Lead Finish	MSL Rating	Package Marking ^[3]
HMC454ST89	Low Stress Injection Molded Plastic	Sn/Pb Solder	MSL1 ^[1]	H454 XXXX
HMC454ST89E	RoHS-compliant Low Stress Injection Molded Plastic	100% matte Sn	MSL1 ^[2]	H454 XXXX

[1] Max peak reflow temperature of 235 °C

[2] Max peak reflow temperature of 260 °C

[3] 4-Digit lot number XXXX



Pin Descriptions

Pin Number	Function	Description	Interface Schematic
1	RFIN	This pin is AC coupled. Off chip matching components are required. See Application Circuit herein.	
3	RFOUT	RF output and DC Bias input for the output amplifier stage. Off chip matching components are required. See Application Circuit herein.	
2,4	GND	These pins & package bottom must be connected to RF/DC ground.	

900 MHz Application Circuit, Compact Layout

This circuit was used to specify the performance for 894-960 MHz operation. This circuit will satisfy many applications from 700 to 1200 MHz. Contact the HMC Applications Group for assistance in optimizing performance for your application.

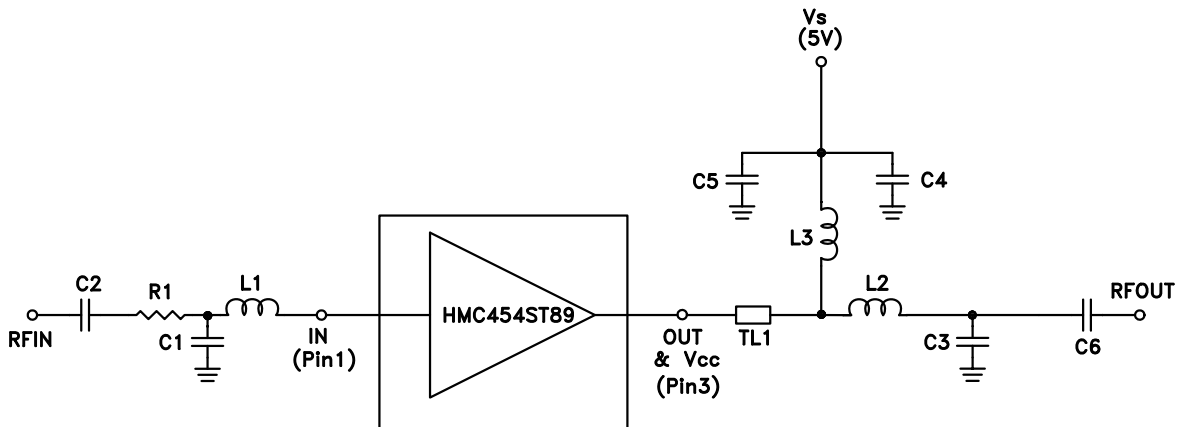

	TL1
Impedance	50 Ohm
Physical Length	0.050"
Electrical Length	2.5°
PCB Material: 10 mil Rogers 4350, Er = 3.48	

Recommended Component Values	
L1, L2	1 nH
L3	36 nH
R1	5.1 Ohms
C1	8 pF
C2	22 pF
C3	2.7 pF
C4, C6	100 pF
C5	2.2 μF

Information furnished by Analog Devices is believed to be accurate and reliable. However, no responsibility is assumed by Analog Devices for its use, nor for any infringements of patents or other rights of third parties that may result from its use. Specifications subject to change without notice. No license is granted by implication or otherwise under any patent or patent rights of Analog Devices. Trademarks and registered trademarks are the property of their respective owners.

For price, delivery, and to place orders: Analog Devices, Inc., One Technology Way, P.O. Box 9106, Norwood, MA 02062-9106 Phone: 781-329-4700 • Order online at www.analog.com Application Support: Phone: 1-800-ANALOG-D



900 MHz Evaluation PCB



List of Materials for Evaluation PCB 107755 [1]

Item	Description
J1 - J2	PCB Mount SMA Connector
J3 -J4	DC Pins
C1	8 pF Capacitor, 0402 Pkg.
C2	22 pF Capacitor, 0402 Pkg.
C3	2.7 pF Capacitor, 0402 Pkg.
C4, C6	100 pF Capacitor, 0402 Pkg.
C5	2.2 μF Capacitor, Tantalum
L1, L2	1 nH Inductor, 0402 Pkg.
L3	36 nH Inductor, 0402 Pkg.
R1	5.1 Ohms
U1	HMC454ST89 / HMC454ST89E Linear Amp
PCB [2]	107753 Evaluation PCB, 10 mils

The circuit board used in this application should use RF circuit design techniques. Signal lines should have 50 Ohm impedance while the package ground leads and exposed paddle should be connected directly to the ground plane similar to that shown. A sufficient number of via holes should be used to connect the top and bottom ground planes. The evaluation board should be mounted to an appropriate heat sink. The evaluation circuit board shown is available from Hittite upon request.

[1] Reference this number when ordering complete evaluation PCB

[2] Circuit Board Material: Rogers 4350, Er = 3.48



1960 & 2140 MHz Application Circuit

This circuit was used to specify the performance for 1800-2000 and 2000-2200 MHz operation. This circuit will satisfy many applications from 1700 to 2500 MHz. Contact the HMC Applications Group for assistance in optimizing performance for your application.

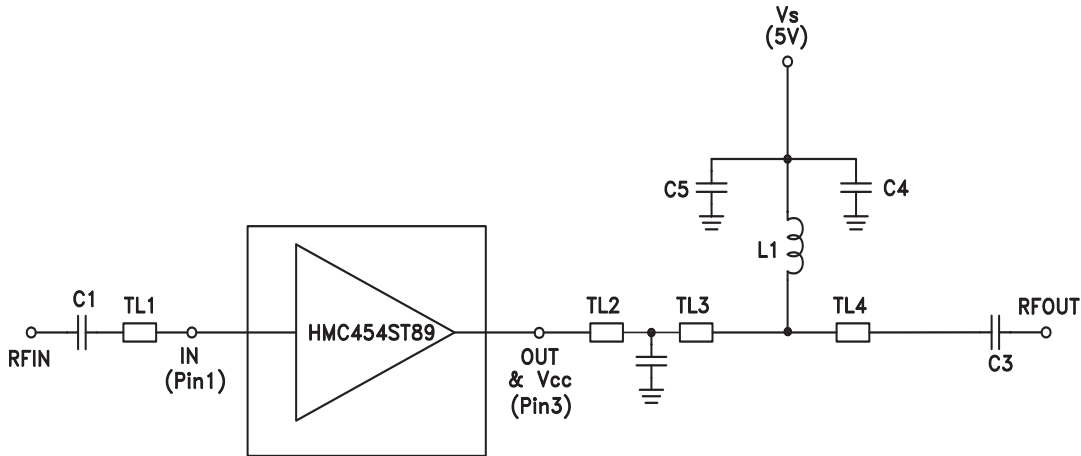

	TL1	TL2	T3	TL4
Impedance	50 Ohm	50 Ohm	50 Ohm	50 Ohm
Physical Length	0.32"	0.10"	0.07"	0.17"
Electrical Length	34°	11°	8°	18.5°
PCB Material: 10 mil Rogers 4350, Er = 3.48				

Recommended Component Values	
L1	8.2 nH
C1	1 pF
C2	1.2 pF
C3	3 pF
C4	100 pF
C5	2.2 μF



1960 & 2140 MHz Evaluation PCB

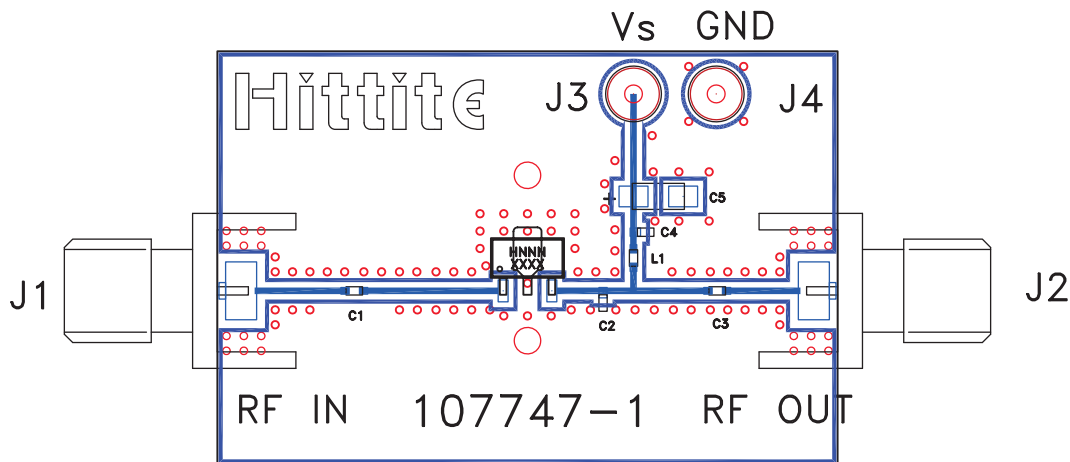

List of Materials for Evaluation PCB 107749 [1]

Item	Description
J1 - J2	PCB Mount SMA Connector
J3 - J4	DC Pins
C1	1.0 pF Capacitor, 0402 Pkg.
C2	1.2 pF Capacitor, 0402 Pkg.
C3	3.0 pF Capacitor, 0402 Pkg.
C4	100 pF Capacitor, 0402 Pkg.
C5	2.2 μF Capacitor, Tantalum
L1	8.2 nH Inductor, 0402 Pkg.
U1	HMC454ST89 / HMC454ST89E
PCB [2]	107747 Evaluation PCB, 10 mils

[1] Reference this number when ordering complete evaluation PCB

[2] Circuit Board Material: Rogers 4350, Er = 3.48

The circuit board used in this application should use RF circuit design techniques. Signal lines should have 50 Ohm impedance while the package ground leads and exposed paddle should be connected directly to the ground plane similar to that shown. A sufficient number of via holes should be used to connect the top and bottom ground planes. The evaluation board should be mounted to an appropriate heat sink. The evaluation circuit board shown is available from Hittite upon request.



Alternative 900 MHz Application Circuit, Optimal OIP3 Layout

This alternate application circuit for 900 MHz applications features a resonating I/O structure on the PCB that, while using more PCB area, will improve output IP3 from +40 dBm to +42 dBm. This circuit will satisfy many applications from 700 to 1200 MHz as the typical performance below demonstrates. Contact the HMC Applications Group for assistance in optimizing performance for your application.

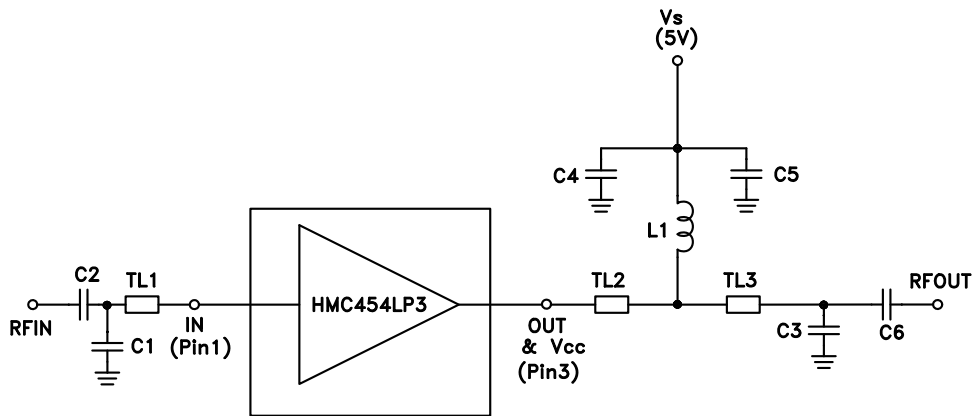

	TL1	TL2	TL3
Impedance	50 Ohm	50 Ohm	50 Ohm
Physical Length	0.35"	0.05"	0.53"
Electrical Length	18°	2.5°	27°
PCB Material: 10 mil Rogers 4350, Er = 3.48			

Recommended Component Values	
L1	18 nH
C1	4 pF
C2, C6	10 pF
C3	3 pF
C4	100 pF
C5	2.2 μF

Broadband Gain & Return Loss



Output IP3 & P1dB



Information furnished by Analog Devices is believed to be accurate and reliable. However, no responsibility is assumed by Analog Devices for its use, nor for any infringements of patents or other rights of third parties that may result from its use. Specifications subject to change without notice. No license is granted by implication or otherwise under any patent or patent rights of Analog Devices. Trademarks and registered trademarks are the property of their respective owners.

For price, delivery, and to place orders: Analog Devices, Inc., One Technology Way, P.O. Box 9106, Norwood, MA 02062-9106 Phone: 781-329-4700 • Order online at www.analog.com Application Support: Phone: 1-800-ANALOG-D



Alternate 900 MHz Evaluation PCB

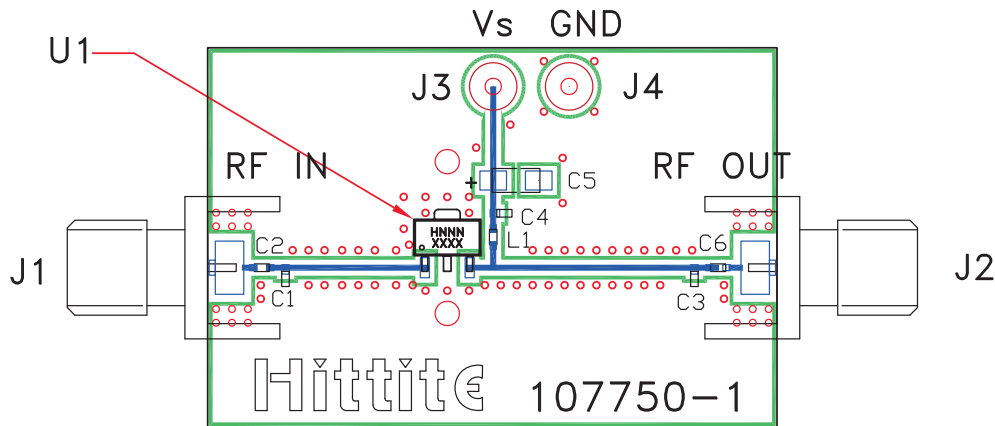

List of Materials

Item	Description
J1 - J2	PCB Mount SMA Connector
J3 - J4	DC Pins
C1	4 pF Capacitor, 0402 Pkg.
C2, C6	10 pF Capacitor, 0402 Pkg.
C3	3.0 pF Capacitor, 0402 Pkg.
C4	100 pF Capacitor, 0402 Pkg.
L1	18 nH Inductor, 0402 Pkg.
U1	HMC454ST89 / HMC454ST89E
PCB*	107750 Evaluation PCB, 10 mils

* Circuit Board Material: Rogers 4350, Er = 3.48

The circuit board used in this application should use RF circuit design techniques. Signal lines should have 50 Ohm impedance while the package ground leads and exposed paddle should be connected directly to the ground plane similar to that shown. A sufficient number of via holes should be used to connect the top and bottom ground planes. The evaluation board should be mounted to an appropriate heat sink. The evaluation circuit board shown is available from Hittite upon request.



Компания «ЭлектроПласт» предлагает заключение долгосрочных отношений при поставках импортных электронных компонентов на взаимовыгодных условиях!

Наши преимущества:

- Оперативные поставки широкого спектра электронных компонентов отечественного и импортного производства напрямую от производителей и с крупнейших мировых складов;
- Поставка более 17-ти миллионов наименований электронных компонентов;
- Поставка сложных, дефицитных, либо снятых с производства позиций;
- Оперативные сроки поставки под заказ (от 5 рабочих дней);
- Экспресс доставка в любую точку России;
- Техническая поддержка проекта, помощь в подборе аналогов, поставка прототипов;
- Система менеджмента качества сертифицирована по Международному стандарту ISO 9001;
- Лицензия ФСБ на осуществление работ с использованием сведений, составляющих государственную тайну;
- Поставка специализированных компонентов (Xilinx, Altera, Analog Devices, Intersil, Interpoint, Microsemi, Aeroflex, Peregrine, Syfer, Eurofarad, Texas Instrument, Miteq, Cobham, E2V, MA-COM, Hittite, Mini-Circuits, General Dynamics и др.);

Помимо этого, одним из направлений компании «ЭлектроПласт» является направление «Источники питания». Мы предлагаем Вам помощь Конструкторского отдела:

- Подбор оптимального решения, техническое обоснование при выборе компонента;
- Подбор аналогов;
- Консультации по применению компонента;
- Поставка образцов и прототипов;
- Техническая поддержка проекта;
- Защита от снятия компонента с производства.



Как с нами связаться

Телефон: 8 (812) 309 58 32 (многоканальный)

Факс: 8 (812) 320-02-42

Электронная почта: org@eplast1.ru

Адрес: 198099, г. Санкт-Петербург, ул. Калинина, дом 2, корпус 4, литера А.